



DEXTER[®]
LAUNDRY











**C-Series OPL Express Washers
WN0650, WN0750, WN0950, WN1450
(Express Washers 200G)**

Parts & Service Manual

Equipment Safety Warnings

Symbols and Terminology Used in this Equipment

| | |
|--|--|
|  DANGER | Indicates an imminently hazardous situation, which if not avoided, will result in death or serious injury. |
|  WARNING | Indicates a potentially hazardous situation, which if not avoided could result in death or serious injury. |
|  CAUTION | Indicates a potentially hazardous situation which, if not avoided, may result in minor or moderate injury. It may also be used to alert against unsafe practices. Minor burns, pinch points that result in bruises and minor chemical irritation. |
| NOTICE | Indicates information or a company policy that relates directly or indirectly to the safety of personnel or protection of property. |
|  | This is the user caution symbol. It indicates a condition where damage to the equipment resulting in injury to the operator could occur if operational procedures are not followed. TO REDUCE THE RISK OF DAMAGE OR INJURY, refer to accompanying documents; follow all steps or procedures as instructed. |
|  | This is the electrical hazard symbol. It indicates that there are DANGEROUS HIGH VOLTAGES PRESENT inside the enclosure of this product. TO REDUCE THE RISK OF FIRE OR ELECTRIC SHOCK, do not attempt to open the enclosure or gain access to areas where you are not instructed to do so. REFER SERVICING TO QUALIFIED SERVICE PERSONEL ONLY |
|  | Caution! There are sharp edges on various sheet metal parts internal to the enclosure. Use safety consciousness when placing or moving your hands while working in the interior of this equipment. |
|  | Caution! To reduce the risk of damage to the Water Inlet Valve, do not supply inlet water with a temperature that exceeds 70° C. |
|  | Caution! To reduce the risk of fire or explosion, do not operate this equipment in any hazardous classified (ATEX) environment. |

Equipment Safety Warnings

Symbols and Terminology Used in this Equipment



Warning! Do not operate equipment if door glass is damaged in any way.



Warning! Keep clear of rotating parts.



Prohibited! Do not enter this equipment or space.



Prohibited! Do not step or stand on this equipment.



Prohibited! Do not operate without all guards and covers in place.









Prohibited! Do not operate without all guards and covers in place.



Prohibited! Do not wash clothing impregnated with flammable liquids (petrochemical).







Prohibited! Do not allow children to play in or around equipment.

| | |
|---|---|
|  | <p>Indicates an imminently hazardous situation, which if not avoided, <u>will result</u> in death or serious injury.</p> |
|  | <p>Indicates a potentially hazardous situation, which if not avoided <u>could result</u> in death or serious injury.</p> |
|  | <p>Indicates a potentially hazardous situation which, if not avoided, <u>may result</u> in minor or moderate injury. It may also be used to alert against unsafe practices. Minor burns, pinch points that result in bruises and minor chemical irritation.</p> |
|  | <p>Indicates information or a company policy that relates directly or indirectly to the safety of personnel or protection of property.</p> |
|  | <p>This is the user caution symbol. It indicates a condition where damage to the equipment resulting in injury to the operator could occur if operational procedures are not followed. TO REDUCE THE RISK OF DAMAGE OR INJURY, refer to accompanying documents; follow all steps or procedures as instructed.</p> |
|  | <p>This is the electrical hazard symbol. It indicates that there are DANGEROUS HIGH VOLTAGES PRESENT inside the enclosure of this product. TO REDUCE THE RISK OF FIRE OR ELECTRIC SHOCK, do not attempt to open the enclosure or gain access to areas where you are not instructed to do so. REFER SERVICING TO QUALIFIED SERVICE PERSONEL ONLY</p> |
|  | <p>Caution! To reduce the risk of fire or explosion, do not operate this equipment in any hazardous classified (ATEX) environment.</p> |



WARNING

| | |
|---|---|
|  | <ul style="list-style-type: none">• All washers must be installed in accordance to all applicable electrical, plumbing and all other local codes.• These installation and operation instructions are for use by qualified personnel only. To avoid injury and electrical shock, do not perform any servicing other than that contained in the installation and operation instructions, unless qualified. |
|  | <p>Do not install washers in an explosive atmosphere.</p> |
|  | <ul style="list-style-type: none">• Care must be stressed with all foundation work to ensure a stable unit installation, eliminating possibilities of excessive vibration.• Foundation must be level within 13 mm to ensure proper washer operation. |
|  | <p>Do not operate washer if door glass is damaged in any way.</p> |
|  | <p>Do not wash clothing impregnated with flammable liquids (petrochemical).</p> |



WARNING







| | |
|--|---|
| | <p>Children should be supervised to ensure they do not operate or play in or around equipment.</p> |
| | |
| | <p>Keep all panels in place to protect against electrical shock and injury and add rigidity to washer.</p> |

This appliance is not intended for use by persons (including children) with reduced physical, sensory or mental capabilities, or lack of experience and knowledge, unless they have been given supervision or instruction concerning use of the appliance by a person responsible for their safety.

A washer should not be allowed to operate if any of the following occur:

- **Excessive high water level.**
- **Machine is not connected to a properly earthed circuit.**
- **Door does not remain securely locked during the entire cycle.**
- **Vibration or shaking from an inadequate mounting or foundation**

| | |
|---|--|
|  | <p>Warning! Do not operate equipment if door glass is damaged in any way.</p> |
|  | <p>Warning! Keep clear of rotating parts.</p> |
|  | <p>Prohibited! Do not enter this equipment or space.</p> |
|  | <p>Prohibited! Do not step or stand on this equipment.</p> |
|  | <p>Prohibited! Do not operate without all guards and covers in place.</p> |
|  | <p>Prohibited! Do not operate without all guards and covers in place.</p> |
|  | <p>Prohibited! Do not wash clothing impregnated with flammable liquids (petrochemical).</p> |
|  | <p>Prohibited! Do not allow children to play in or around equipment.</p> |

| | |
|---|---|
|  | <p>Prohibited! Do not attempt to open, touch, or proceed before referring to the manual or unless qualified.</p> |
|  | <p>Mandatory! Read all supporting documentation before operating or maintaining equipment.</p> |
|  | <p>Mandatory! Disconnect power before servicing equipment.</p> |
|  | <p>Mandatory! Lock out and tag out before servicing this equipment.</p> |
|  | <p>Mandatory! Disconnect water supply before servicing equipment.</p> |
|  | <p>Mandatory! Children should be supervised to ensure they do not operate equipment.</p> |

Dexter Safety Guidelines



WARNING

These washers are equipped with devices and features relating to their safe operation. To avoid injury or electrical shock, do not perform and service, unless qualified to do so.

FOR SAFETY

1. Always shut off power and water supply and also discharge capacitors before servicing.
2. Do not overload the washer.
3. Do not attempt to open door if cylinder is in motion or contains water.
4. Do not mechanically force or override door lock in any way.
5. Do not bypass any safety devices of this washer.
6. Do not use volatile or flammable substances in or near this washer.
7. Keep all panels in place. They protect against shock and injury and add rigidity to the washer.

A machine should not be allowed to operated if any of the following occur:

- Excessively high water level.
- Machine is not connected to a properly grounded circuit.
- Loading door does not remain securely locked during the entire cycle.
- Vibration or shaking from an inadequate mounting or foundation.

To activate your warranty, be sure to return your red warranty form to the factory. Please have serial number and model ready when calling for assistance.

Table of Contents

Section 1: Machine Mounting & Installation

| | |
|--------------------------|----|
| T-750..... | 14 |
| T-950 | 15 |
| T-1450 | 16 |
| T-750 Installation | 17 |
| T-900 Installation | 18 |
| T-950 Installation | 19 |
| T-1200 Installation..... | 20 |
| T-1450 Installation..... | 21 |

Section 2: Machine Installation & Operating Instructions

| | |
|--|----|
| Basic Installation..... | 24 |
| Electrical Connections & Fusing Requirements . | 25 |
| Emergency Stop Button | 26 |
| Machine Chemical Connection | 27 |
| Detergent Measurements by Model..... | 28 |

Section 3: Machine Programming Instructions

| | |
|--------------------------|-------|
| Programming Presets..... | 31-32 |
| Wash Cycle | |
| Programming..... | 33 |
| Rapid Advance Mode..... | 34 |

Section 4: Trouble Shooting

| | |
|--|---------|
| Common Troubleshooting Solutions Pages.. | 36-38 |
| Troubleshooting Machine Fault | |
| Errors Pages..... | 39-42 |
| Motor Resistance Chart..... | 43 |
| Variable Frequency Drive Control | |
| Digital Readout Faults | 44 & 45 |

Section 5: Machine Service Procedures

| | |
|-----------------------------------|----|
| Lower Service Panel Removal | 48 |
| Top Panel Removal..... | 48 |

| | |
|---|---------|
| Front Panel Removal | 48 |
| Back Panel Removal | 48 |
| Drain Valve Access | 48 |
| Drain Valve Cleaning | 48 |
| Detergent Dispenser | 48 |
| Vacuum Breaker/ Air Gap | 49 |
| Water Valves | 49 |
| Door Lock Assembly Operation | 49 |
| Adjustment for the Door Lock Assembly | 49 & 50 |
| Adjusting the Loading Door | 51 |
| Loading Door Removal | 51 |
| Loading Door Hinge Removal | 51 |
| Loading Door Disassembly | 52 |
| Loading Door Reassembly | 52 |
| Control Panel Name Plate Decal | 52 |
| Name Plate Removal | 52 |
| Re-Installation of Name Plate | 52 |
| Outer Cabinet Removal | 53 |
| Door Locking Motor | 53 |
| Thermoactuators | 53 |
| Lock Thermoactuator | 53 |
| Unlock Thermoactuator | 53 |
| Drive Belt Removal | 53 |
| Tub Back, Bearing and Cylinder Assembly | 54 |
| Basket Pulley, Bearing Housing, Water Seals & Tub Back | 54-56 |
| T-750 Bolt Torque Chart | 57 |
| T-9000, T-950, T-1200 & T-1450 Bolt Torque Chart | 57 |

Section 6:

| | |
|--|----|
| Control Mounting Trough | 60 |
| Main Data Communication Cable | 60 |
| Circuit Breaker/Fuse | 60 |
| Main Control Printed Circuit Board | 60 |
| PCB Transformer Step Down | 60 |
| Controls Transformer | 60 |
| Main Relay Printed Circuit Board | 60 |
| Pressure Switch | 61 |
| Power Connection Terminal Block | 61 |

| | |
|---|----|
| LED Printed Circuit Board Temperature & Start/ Display Push Button | 61 |
| Delta Variable Frequency Drive | 62 |
| Delta VFD Motor Leads | 62 |
| Delta VFD Dynamic Braking Resistors | 62 |
| Delta VFD Cooling Fan | 62 |

Section 7:

| | |
|---|--------|
| Machine Electrical & Wiring Schematics Start Circuit | 64 |
| Fill Circuit | 64 |
| Wash Circuit | 65 |
| Drain, Rinse 1 & 2 & Final Rinse Circuit | 65 |
| Extract Circuit | 65 |
| Thermoactuator and Shake Out Circuit | 65 |
| End of Cycle Circuit | 65 |
| Diagrams & Schematics | 68- 77 |

Section 8: Parts Data

| | |
|--|-----------|
| A-Series Accessories | 80 |
| Wiring Harness Part # by Model | 81 |
| Cabinet and Front Panel Group Part # by Model | 82 & 83 |
| Soap Dish | 84 & 85 |
| Rear View Access Part # by Model | 86 & 87 |
| Rear Chanel | 88 & 89 |
| Cylinder, Seals & Bearings Part # by Model | 90 & 91 |
| Door Lock Part # by Model | 92 & 93 |
| Loading Door Part # by Model | 94 & 95 |
| Water Inlet Part # by Model | 96 & 97 |
| Water Inlet Valve Breakdown I | 98 & 99 |
| Drain Valve Group Part # by Model | 100 |
| Chassis and Drain Part # by Model | 102 & 103 |
| Electrical Components - Top Compartment | 104 & 105 |
| Control Panel Part # by Model | 106 & 107 |
| Labels and Diagrams All WCAD Models | 108 |

Section 9:
50 Hz Models

-39 Parts.....112-114

50HZ Diagrams & Schematics.....116-125

Section 10:
Maintenance

Preventative Maintenance128

Section 1:

Machine Mounting

Specifications for below models are outlined in this book:

| | | | | |
|--------|---------------|---------------|-------|-----------------------------|
| T-650 | WN0650XA-12EV | 208-240 volts | 60hz | Single Phase or Three Phase |
| T-750 | WN0750XA-12EV | 208-240 volts | 60hz. | Single Phase or Three Phase |
| T-950 | WN0950XA-12EV | 208-240 volts | 60hz | Single Phase or Three Phase |
| T-1450 | WN1450XA-12EV | 208-240 volts | 60 hz | Single Phase or Three Phase |

T650 Machine Dimensions

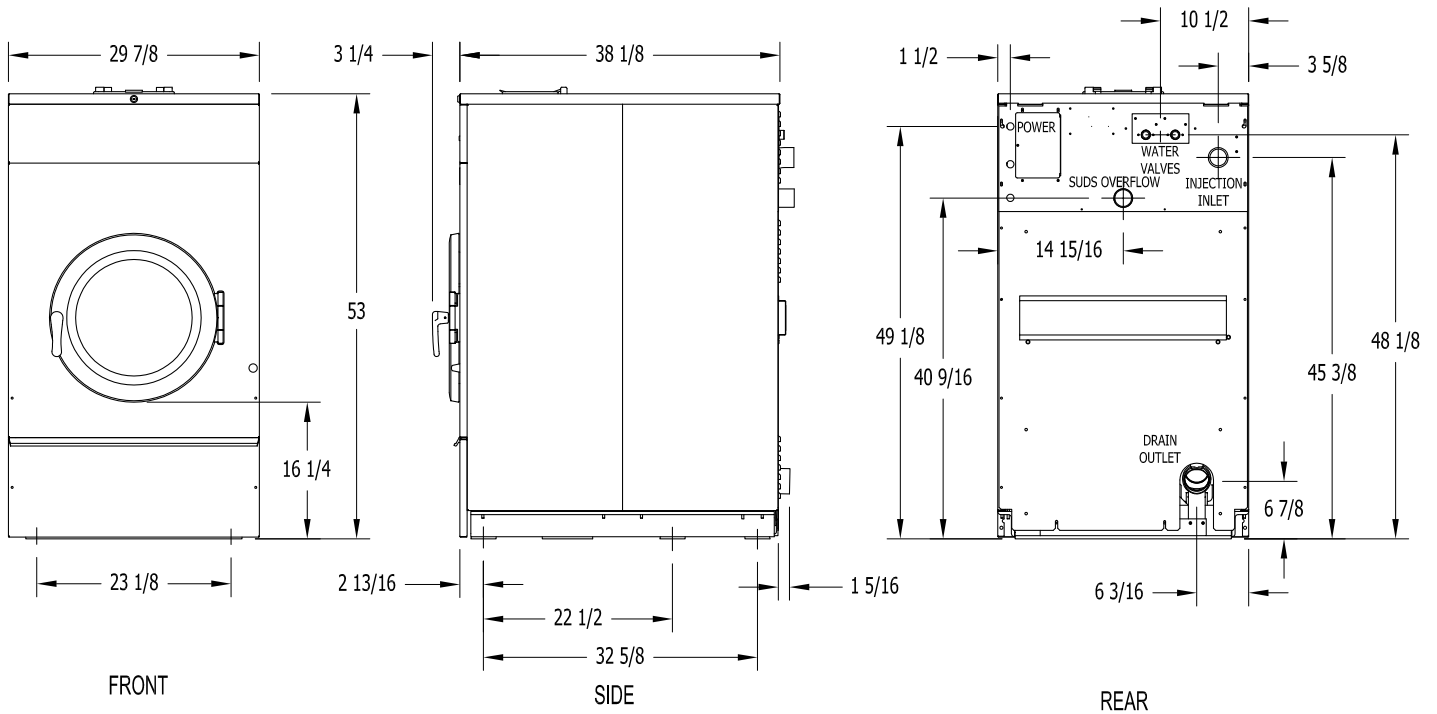

T750 Machine Dimensions

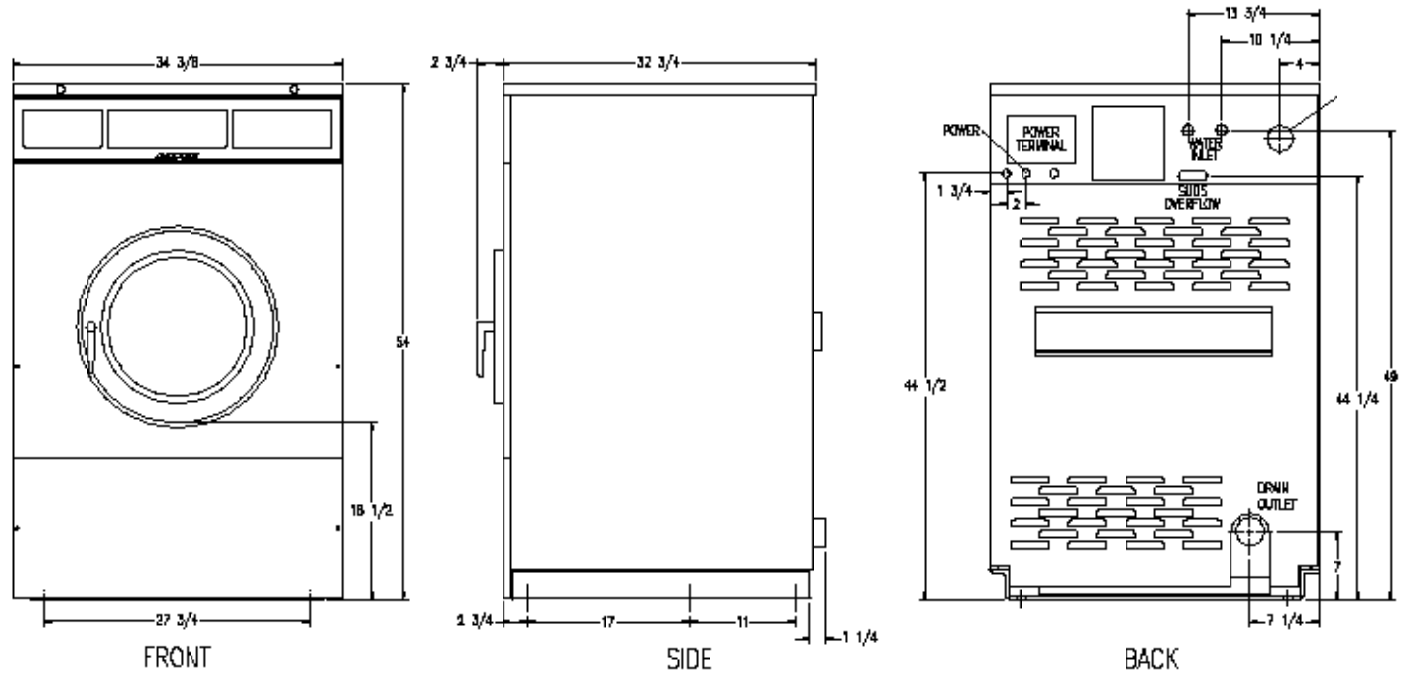

T950 Machine Dimensions

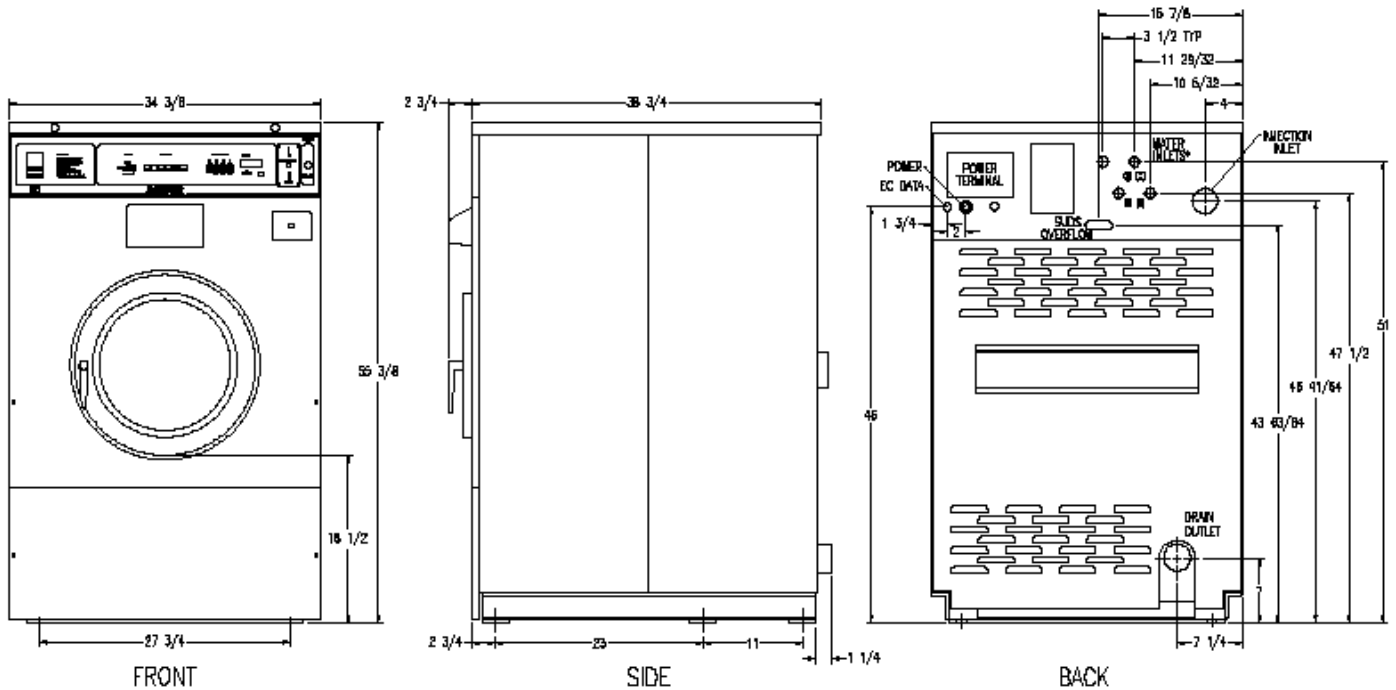

T-1450 Machine Dimensions

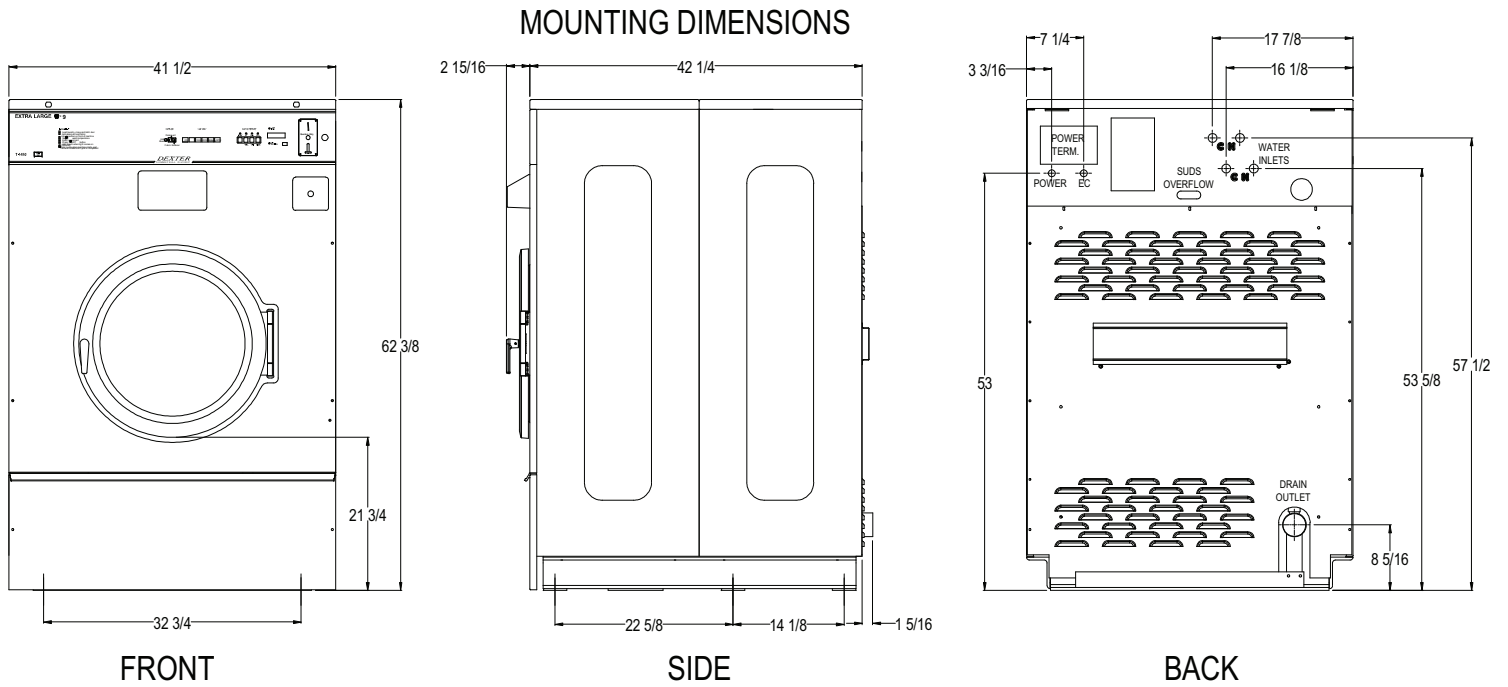

T650 Mounting Dimensions

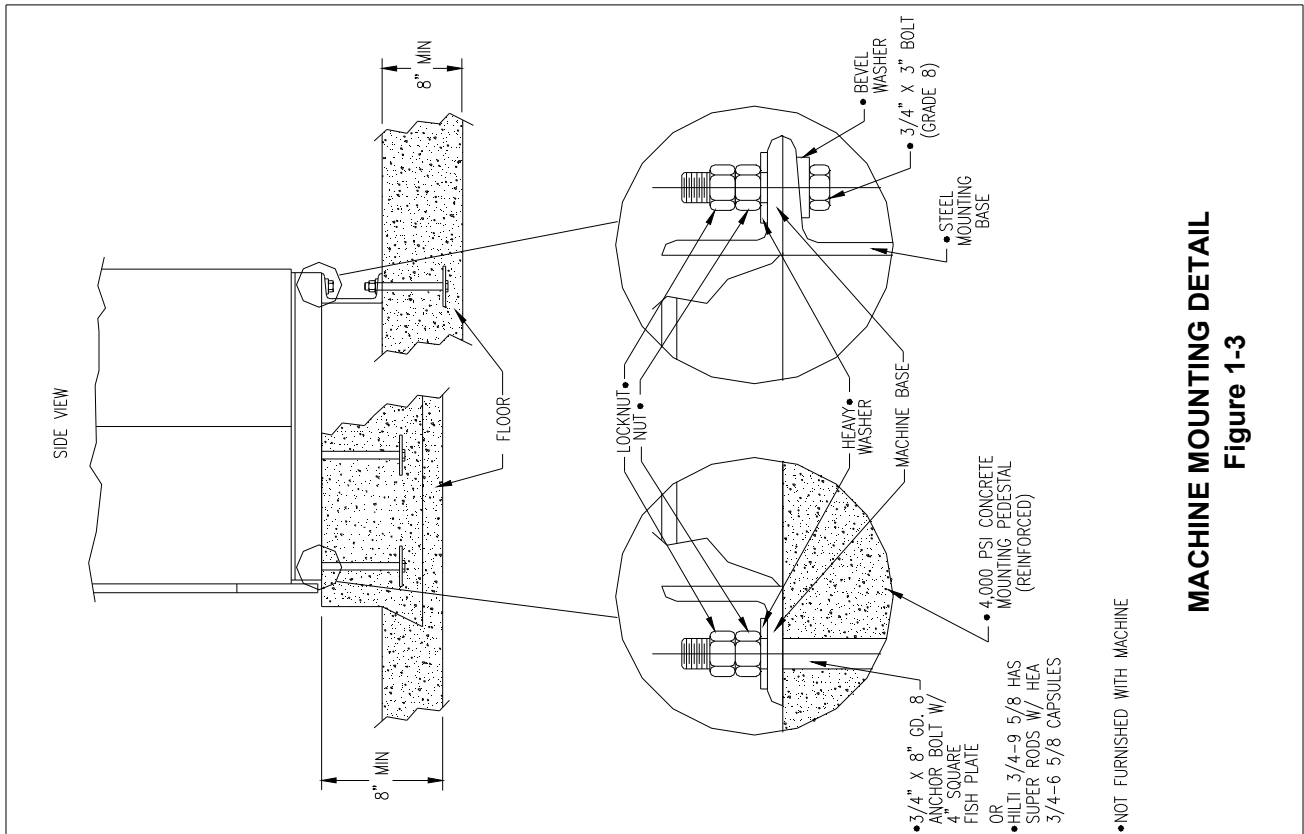

3/4" X 8" GD. 8 BOLTS
HEADED BY 4" SQ. FISH PLATE OR EQUIV.

OR

'HILTI' ADHESIVE ANCHORING SYSTEM.
USE HILTI 'HEA' 3/4-6 5/8 ADHESIVE CAPSULES
AND HILTI 'HAS' SUPER RODS 3/4-9 5/8
FOR MORE INFORMATION CALL
HILTI CUSTOMER SERVICE
1-800-879-8000

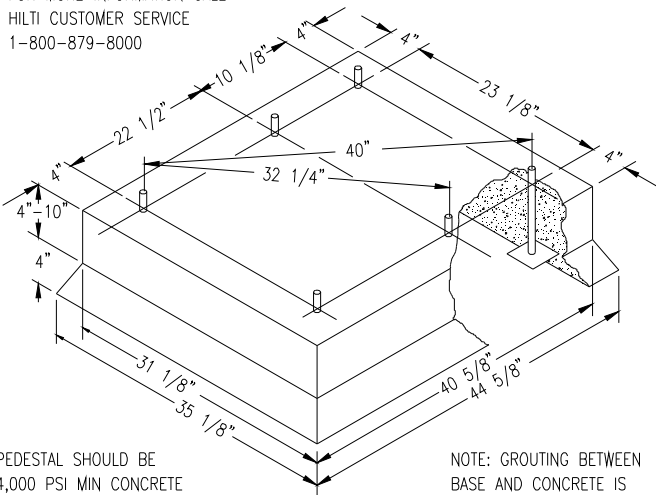

CONCRETE PEDESTAL MOUNTING
Figure 1-1

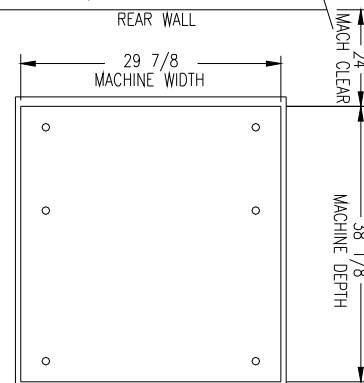
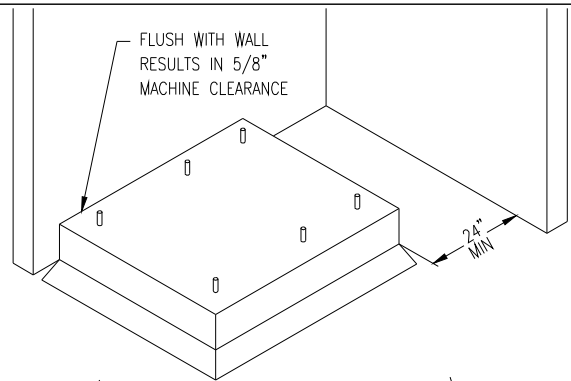

FLOOR OUTLINE
Figure 1-2

T750 Mounting Dimensions

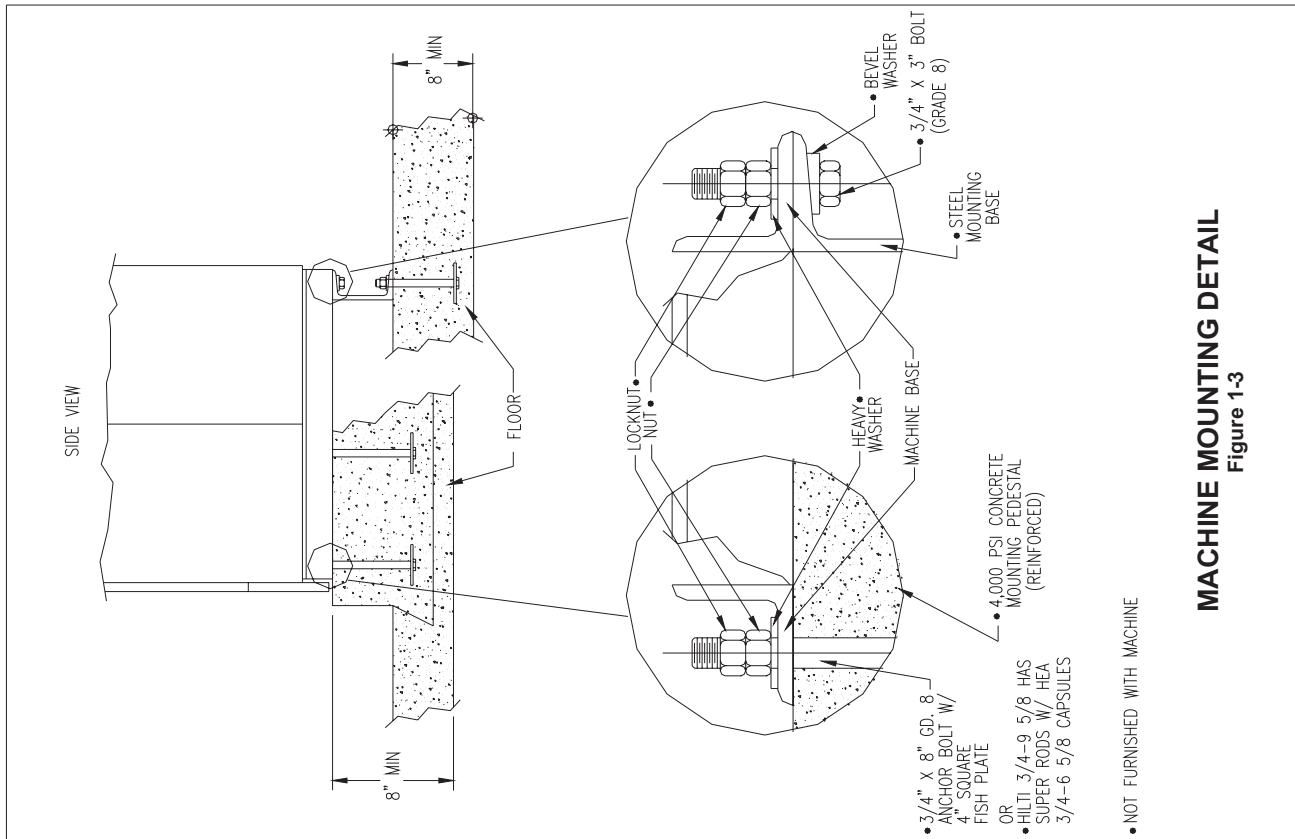

MACHINE MOUNTING DETAIL
Figure 1-3

3/4" X 8" GD. 8 BOLTS
HEADED BY 4" SQ. FISH PLATE OR EQUIV.

OR

'HILTI' ADHESIVE ANCHORING SYSTEM.

USE HILTI 'HVU' 3/4-6 5/8 ADHESIVE CAPSULES

AND HILTI 'HAS' SUPER RODS 3/4-9 5/8

FOR MORE INFORMATION CALL

HILTI CUSTOMER SERVICE

1-800-879-8000

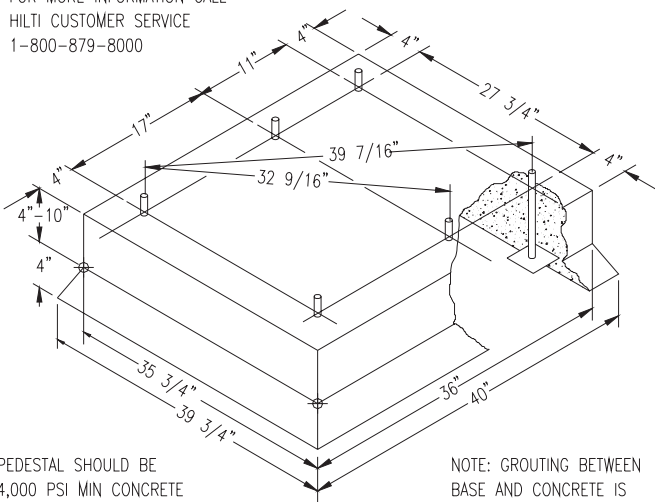

PEDESTAL SHOULD BE
4,000 PSI MIN CONCRETE
REINFORCED WITH
MESH OR RODS.

NOTE: GROUTING BETWEEN
BASE AND CONCRETE IS
REQUIRED.

CONCRETE PEDESTAL MOUNTING

Figure 1-1

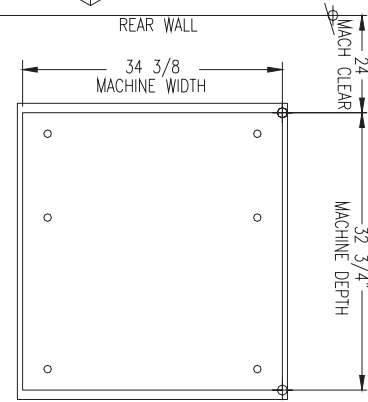
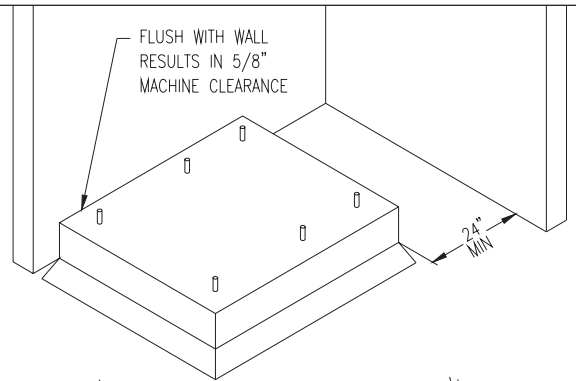

FLOOR OUTLINE

Figure 1-2

T950 Mounting Dimensions

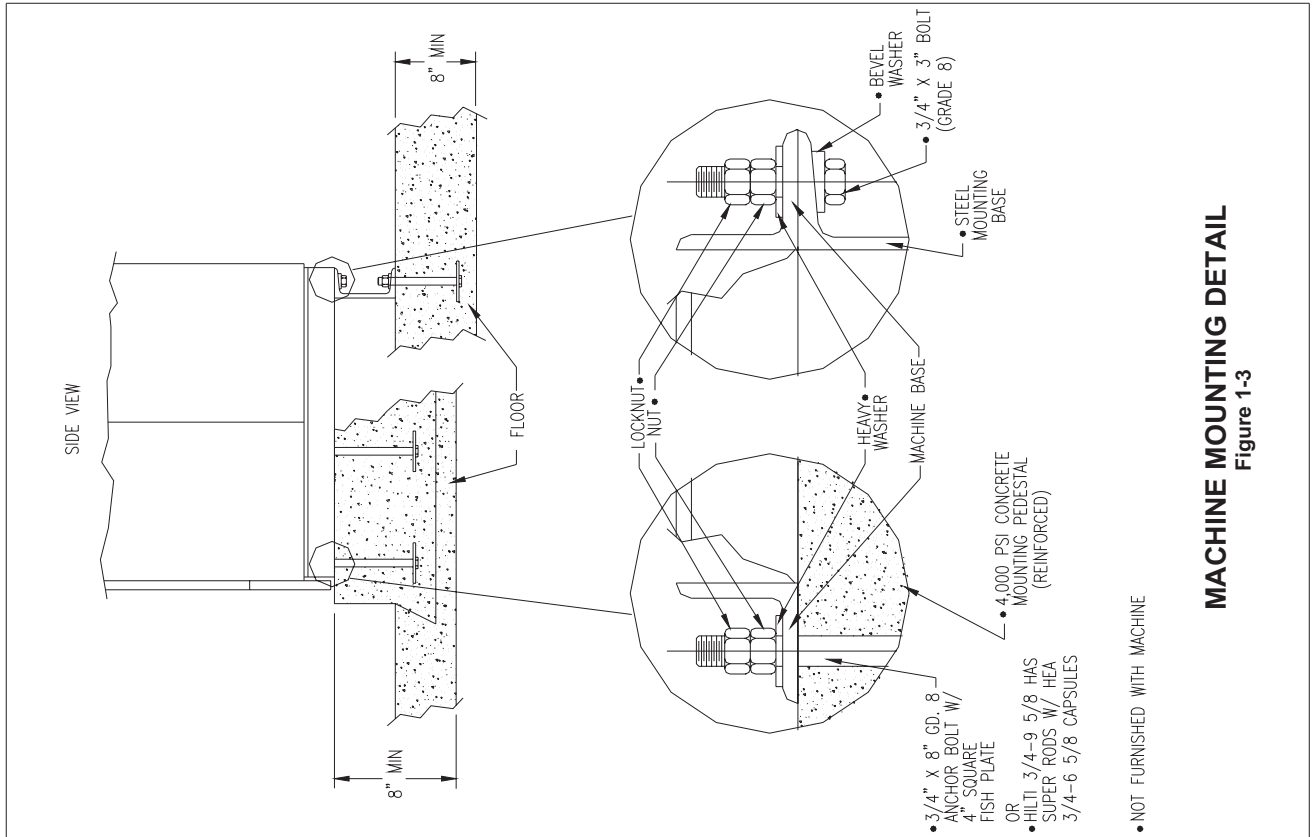

3/4" X 8" GD. 8 BOLTS
HEADED BY 4" SQ. FISH PLATE OR EQUIV.

OR

'HILTI' ADHESIVE ANCHORING SYSTEM.
USE HILTI 'HEA' 3/4-6 5/8 ADHESIVE CAPSULES
AND HILTI 'HAS' SUPER RODS 3/4-9 5/8
FOR MORE INFORMATION CALL
HILTI CUSTOMER SERVICE
1-800-879-8000

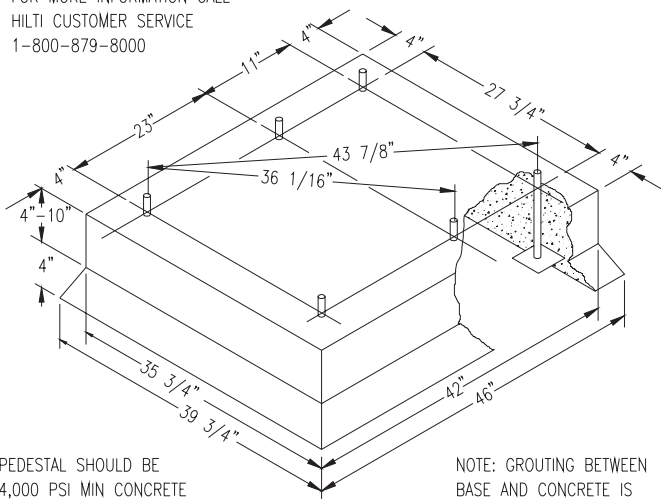

PEDESTAL SHOULD BE
4,000 PSI MIN CONCRETE
REINFORCED WITH
MESH OR RODS.

NOTE: GROUTING BETWEEN
BASE AND CONCRETE IS
HIGHLY RECOMMENDED.

CONCRETE PEDESTAL MOUNTING

Figure 1-1

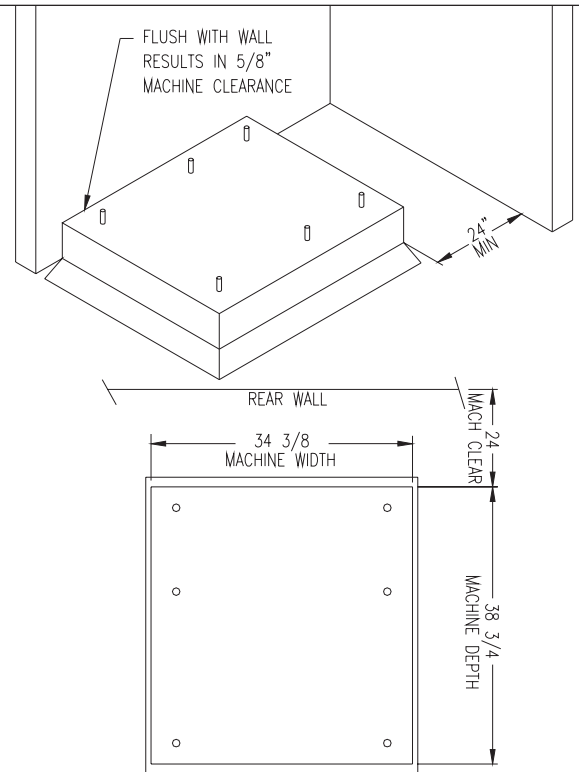

FLOOR OUTLINE

Figure 1-2

T1450 Mounting Pad Dimensions

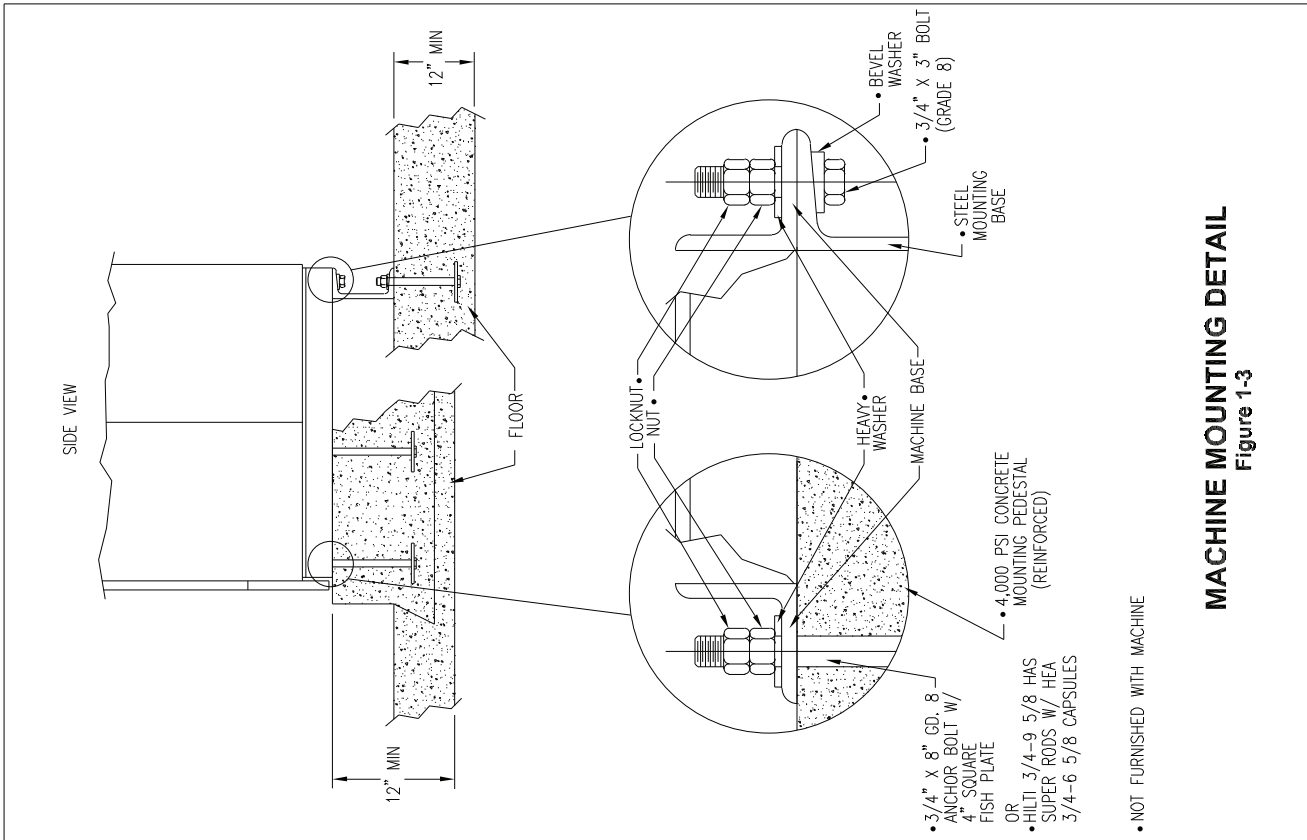

3/4" X 8" GD. 8 BOLTS
HEADED BY 4" SQ. FISH PLATE OR EQUIV.

OR

'HILTI' ADHESIVE ANCHORING SYSTEM.
USE HILTI 'HEA' 3/4-6 5/8 ADHESIVE CAPSULES
AND HILTI 'HAS' SUPER RODS 3/4-9 5/8
FOR MORE INFORMATION CALL
HILTI CUSTOMER SERVICE
1-800-879-8000

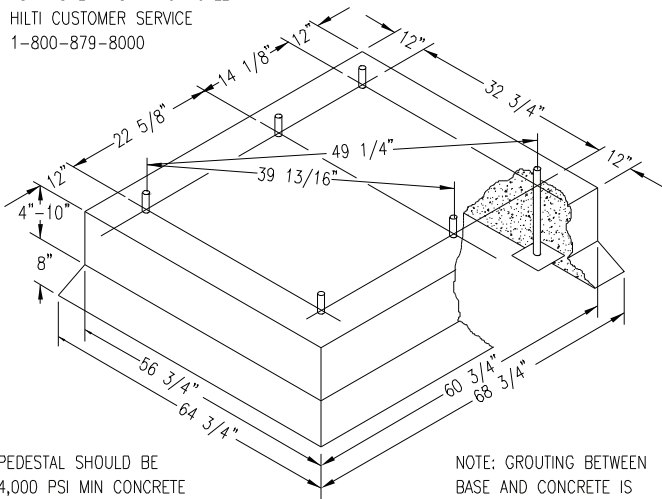

CONCRETE PEDESTAL MOUNTING

Figure 1-1

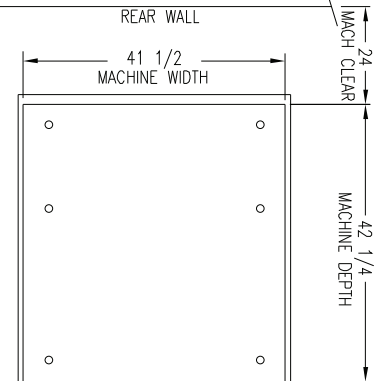
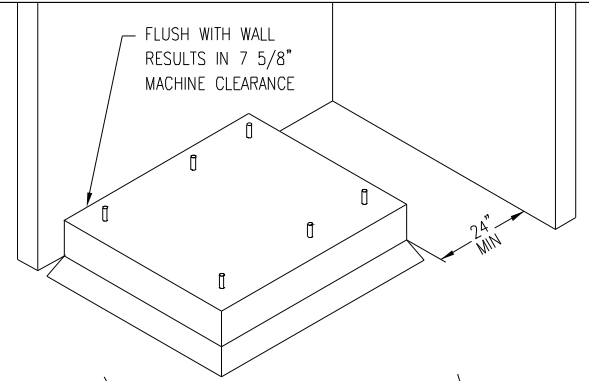

FLOOR OUTLINE

Figure 1-2

Section 2:

Machine Installation & Operating Instructions

Washer Installation

All washers must be installed in accordance with all local, state and national building, electrical, and plumbing codes in effect in the area.

Foundation Requirements

The washer must be securely bolted to a substantial concrete floor, or mounted upon a suitable base which is securely bolted and machine grouted to a substantial concrete floor. Care must be stressed with all foundation work to insure a stable unit, eliminating vibration. All installations must be made on sound concrete floors, (See instillation specifications for the specific model.)

Mounting

A concrete pad or steel base which elevates the machine 4 to 6 inches above the floor level. To provide easy access to the loading door, it is recommended to allow a minimum of 18" of clearance behind the rear of the machine for service as is shown. SIX (6) bolts are required to mount the washer to the steel base or concrete pad. Grouting where base or machine makes contact with concrete is REQUIRED to achieve 100% surface contact and for warranty to be honored.

Note: Premanufactured bases are available from DEXTER factory (see sales dept.)

Mounting Bolts

The preceding pages illustrate the mounting dimensions for the machine and also show a typical concrete pad arrangement.

Note: Mounting bolts should be checked frequently to insure that they remain tight. The machine should be checked with a spinning load to be sure there is no unusual vibration or movement between the machine and the base or floor.

Proper Machine Grout Required Installation

Machine grout must be installed between base (if used) and concrete floor on all side rails and crossmembers. If using a base you must grout between base top and machine frame and all side rails and crossmembers.

Plumbing

Water supply hoses are furnished with each machine. The threaded connections on the hoses are standard garden hose type thread. Separate hot and cold water lines with shut off valves or faucets for inlet hose connections must be provided, maintaining 30 to 120 p.s.i. water flow pressure. The recommended water temperature is 140 degrees.

Drain

The drain outlet tube at the rear of the machine is 3" in outside diameter on models. Adequate fall for this gravity drain must be maintained for proper drainage.

Protective Film

The machine may have protective adhesive film on the front escutcheon area and the front and side stainless steel panels. The film may be peeled off before putting the machine into service.

Electrical

Dexter single/three-phase 208-240VAC 60 Hz washing machines are intended to be permanently installed appliances. No power cord is provided. The machine should be connected to an individual branch circuit not shared by lighting or other equipment. The connection should be sheathed in liquid tight flexible conduit, or equivalent, with conductors of the proper size and insulation. A qualified technician should make such connections in accordance with the wiring diagram.

Each unit should be connected to an individual branch circuit not shared by lighting or other equipment. Conductors of the proper size and insulation (suggested size below) should be used.

To Make Electrical Connections

Disconnect all power to the washer. Remove screw and lift out the cover located in the upper left corner of the machine (as viewed from the back).

- If power is 208-240-3PH-60Hz, connect L1, L2, L3 and ground. If there is a high leg it must be connected to L3. It is highly recommended to use a TVSS. (see Informative inside Washer)
- If power is 208-240-1PH-60Hz, connect L1, L2 and Ground.

NOTE: It is important that the grounding screw next to the power terminal block TB-1 be connected to a good external ground.

Controls Transformer

The controls transformer is located inside the control trough and steps a range of 208 to 240 volts down to 115 volts. There are two terminals on the controls transformer for the primary (incoming) power. Use the terminal marked "208V" for power supplies between 200 and 215 volts. Use the terminal marked "230V" for power supplies between 216 and 240 volts.

NOTE: transformer must be set at proper tap for proper operation.

Electrical Connections

Electrical power connections are made to the small terminal block located in the rear of the control trough. The terminal block is accessed by opening the top panel of the machine.

- 1 Phase or 3 Phase connections
- 208-240 volts, 60 Hz.
- 3 wire plus ground
- Suggested Minimum Wire Size -- 12 Ga.

Fusing Requirements:

Dual element time delay fuse or equivalent breaker of amperage specified below.

- 1 Phase or 3 Phase 15 amp
- WSVD-30

Rotation in extract as viewed through glass door at front of washer models WSVD-30 will be counter-clockwise.

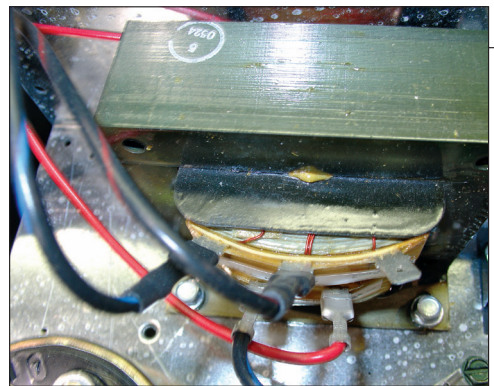
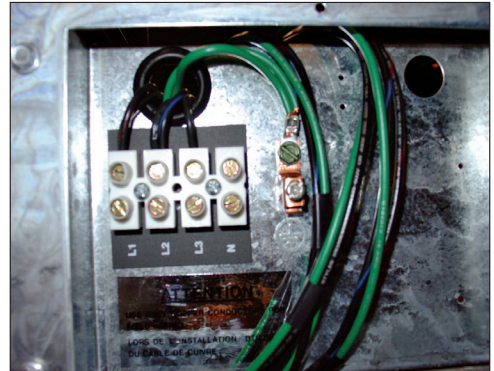

WARNING

Always disconnect electrical power to the machine before performing any adjustments or service.

Liquid Chemical Connection

In the left rear corner of the washer is the chemical injection assembly. This is where all chemical hose connections are made. The chemical hoses should be inserted into the round pvc pipe a minimum of 14" and a maximum of 18" to eliminate chemical buildup in the pipe and/or restrict water flow to the tub.



Injection Source Details

The washer control may be programmed to send output signals for a chemical injection system. There is a separate terminal block for connection of the external injection signals. For the injection sources, program codes 0 through 6 are as shown in the table below. Injection signal will trigger a 120 volt reading at rear terminal block for approximately 5-10 seconds and will start to trigger at about 10-15 seconds after start of fill bath. (Chemical Injection Signals are shown in the programming section.)

**208/240 VAC
Power Connections**

**Ground
Connection**

**120VAC Injector
Supply Connections
Power Connections**

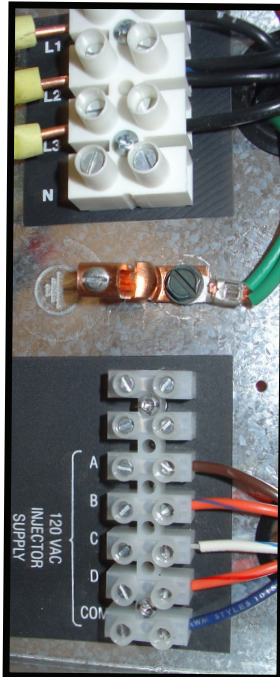

**L1
L2
L3
N (not needed)**

**A
B
C
D
Common**

Dexter Recommended Connections

Detergent
Bleach
Starch
Sour/Softener

Controller Programmed Signals

1
2
3
4
5
6
0

Injection Terminal Block Connection

A
B
C
D
A and B
C and D
None

Note : The Wash Cycle programming mode will automatically exit and return to the Idle mode if no buttons are pushed for one minute.

Washer Operating Instructions

Safety Door Lock

This machine is equipped with a Safety Door Lock that locks the door closed from when the cycle is started until the cycle is complete. The door lock prevents opening the door for up to 3 minutes if the power is interrupted during the cycle.

Starting the Washer

- A. Load the items to be washed in the cylinder and latch the door securely. Be sure clothing does not get caught between the door gasket and tub front when closing the door.

NOTE: To close the door the handle must be in the horizontal position and then moved to the vertical position. After moving the door to the closed position, the handle must be turned down to the vertical position to latch the door for machine operation.

- B. Make the appropriate cycle selection for the wash load by pushing the up and down arrows on the touch pad. Preprogrammed Cycles 1,2,3,4,5, or 6. Each cycle is completely programmable and for instructions see next section in this manual.
- C. To manually add wash compounds, pour low-sudsing powdered detergent into the detergent dispenser on front of the machine. Rinse conditioners may also be added to the dispenser. The correct location of each is shown on the dispenser lid.
- D. To manually add bleach in Rinse, pour bleach in opening. Bleach light will come on during the wash bath only (location shown on dispenser lid) in top or front of washer.
- E. To start the washer, push the green "Start" button
- F. To pause for an extended soak, push the red Stop button for 1 second. To continue the cycle, push the green Start button. enough to reach down to water trap.
- G. To stop and clear the wash cycle, hold the red Stop button for 8 to 10 seconds.
- H. If automatic chemical injection systems are being used, make sure that chemical hoses are inserted correctly in the injection port located at rear corner at red cover. Hoses must be inserted long enough to reach down to water trap.

Safety Door Lock

If power is interrupted the Safety Door Lock delays opening the door until it is safe to do so. If power failure occurs or if power is interrupted during maintenance, it will be necessary to wait 2 to 3 minutes before the door can be opened.

End of Cycle

When the cycle is completed, the washer will stop, the End of Cycle Light will come on, the Buzzer sounds and the loading door will unlock. It can be opened by turning the door handle to the indicated position and pulling. Leave the clothes door open when the machine is not in use helps to eliminate odors that might build up during the wash process.

Detergent Measurements By Washer Model

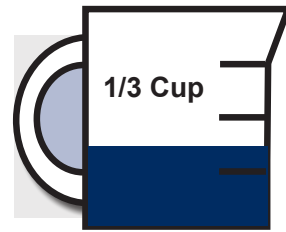

Maxi Load T-650 Washer

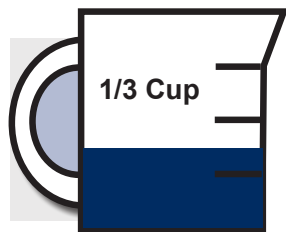

Maxi Load T-750 Washer

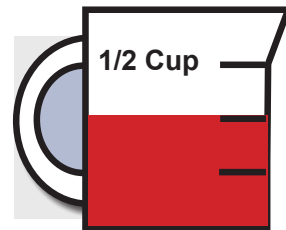

Mega Load T-950 Washer

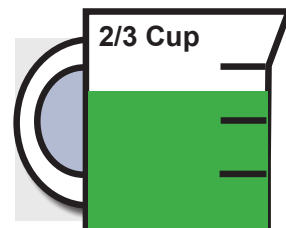

Magnum Load T-1450 Washer



Section 3:

Machine Programming Instructions

Bath Cycle Time "ct"

0 to 15 minutes for Prewash, Rinse1 and Rinse 3 to 15 minutes for Wash and Final Rinse. For the baths that can, if the time is set to zero, then that bath will be eliminated from the cycle.

Bath Water Temperature "t"

HH – hot, CH – warm, CC – cold, EE – no water. The owner can set the bath default. For the wash bath, the default is over ridden for that cycle by the customer when the temperature is selected.

Bath Water Level "L"

LO – low The owner can change the displayed value, but for a coinwasher only LO will be put into the cycle.

Bath Delay Fill "dF"

The selections are "d" for delay the bath time until water level is reached or "t" for decrement bath time during the fill.

Bath Spin Time "S"

0 to 10 minutes for Prewash, Wash, Rinse1 and Rinse2 1 to 10 minutes for Final Spin.

Bath "IS"

The owner can change the displayed value, but for a coin washer only 0 will be put into the cycle.

Washer 6 Default Cycles (Preset at Factory)

There are 6 pre programmed baths on the control which are set up at the factory. The formulas for each are shown on the following pages. Each of these 6 programs can be adjusted and saved as the owner needs.

Cycle 1: Sheets and Pillowcases (Health Care)

| Bath | Bath Cycle Time (min.) | Water Temp. | Water Level | Delay Fill | Spin Time (min.) | Injection Source |
|-------------|-------------------------------|--------------------|--------------------|-------------------|-------------------------|-------------------------|
| Flush | 3 | CH | HI | d | | |
| Prewash | 2 | CH | HI | d | | |
| Wash | 7 | HH | LO | d | 1 | #1(Detergent) |
| Rinse 1 | 7 | HH | LO | d | 2 | #2 (Bleach) |
| Rinse 2 | 2 | CH | HI | d | 1 | |
| Rinse 3 | 2 | CH | HI | d | | |
| Rinse 4 | | | | | | |
| Final Rinse | 4 | CH | LO | d | 4 | #4 (Sour/Soft) |

Cycle 2: Towels / Pads / Diapers (Health Care)

| Bath | Bath Cycle Time (min.) | Water Temp. | Water Level | Delay Fill | Spin Time (min.) | Injection Source |
|-------------|-------------------------------|--------------------|--------------------|-------------------|-------------------------|-------------------------|
| Flush | 3 | CH | HI | d | | |
| Prewash | 2 | CH | HI | d | | |
| Wash | 7 | HH | LO | d | 1 | #1 (Detergent) |
| Rinse 1 | 1 | HH | HI | d | | |
| Rinse 2 | 7 | HH | LO | d | 2 | #2 (Bleach) |
| Rinse 3 | 2 | CH | HI | d | 1 | |
| Rinse 4 | 2 | CH | HI | d | | |
| Final Rinse | 4 | CH | LO | d | 5 | #4 (Sour/Soft) |

Cycle 3: White Towels (Hotel / Motel)

| Bath | Bath Cycle Time (min.) | Water Temp. | Water Level | Delay Fill | Spin Time (min.) | Injection Source |
|-------------|-------------------------------|--------------------|--------------------|-------------------|-------------------------|-------------------------|
| Flush | | | | | | |
| Prewash | | | | | | |
| Wash | 7 | HH | LO | d | 1 | #1(Detergent) |
| Rinse 1 | 1 | HH | HI | d | | |
| Rinse 2 | 7 | HH | LO | d | 2 | #2 (Bleach) |
| Rinse 3 | 2 | CH | HI | d | 1 | |
| Rinse 4 | 2 | CH | HI | d | | |
| Final Rinse | 4 | CH | LO | d | 5 | #4 (Sour/Soft) |

| Cycle 4: Guest Laundry (Hotel / Motel / Healthcare) | | | | | | |
|---|-----------------------|-------------|-------------|------------|-----------------|----------------------|
| Bath | Bath Cycle Time (min) | Water Temp. | Water Level | Delay Fill | Spin Time (min) | Injection Source |
| Flush | 3 | CH | HI | d | | |
| Prewash | | | | | | |
| Wash | 7 | HH | LO | d | 5 | #6(Detergent/Bleach) |
| Rinse 1 | 2 | HH | HI | d | | |
| Rinse 2 | 2 | CH | HI | d | | |
| Rinse 3 | 2 | CH | HI | d | | |
| Rinse 4 | | | | | | |
| Final Rinse | 4 | CH | LO | d | 4 | #4 (Sour/Soft) |

| Cycle 5: Rags and Mops (Hotel / Motel) | | | | | | |
|--|-----------------------|-------------|-------------|------------|-----------------|------------------|
| Bath | Bath Cycle Time (min) | Water Temp. | Water Level | Delay Fill | Spin Time (min) | Injection Source |
| Flush | 3 | CH | HI | d | | |
| Prewash | 2 | CH | HI | d | | |
| Wash | 2 | CH | HI | d | | |
| Rinse 1 | 7 | HH | LO | d | 1 | #1 (Detergent) |
| Rinse 2 | 2 | HH | HI | d | | |
| Rinse 3 | 7 | HH | LO | d | 2 | #2 (Bleach) |
| Rinse 4 | 2 | CH | HI | d | 1 | |
| Final Rinse | 2 | CH | LO | d | 5 | |

| Cycle 6: Colored Cotton Linen (Hotel & Food Service) | | | | | | |
|--|-----------------------|-------------|-------------|------------|-----------------|------------------|
| Bath | Bath Cycle Time (min) | Water Temp. | Water Level | Delay Fill | Spin Time (min) | Injection Source |
| Flush | 3 | CH | HI | d | | |
| Prewash | 2 | CH | HI | d | | |
| Wash | 2 | CH | HI | d | | |
| Rinse 1 | 7 | HH | LO | d | 1 | #1(Detergent) |
| Rinse 2 | 2 | HH | HI | d | | |
| Rinse 3 | 7 | HH | LO | d | 2 | #2 (Bleach) |
| Rinse 4 | 2 | CH | HI | d | 1 | |
| Final Rinse | 2 | CH | LO | d | 5 | |

Washer Programming Instructions

THERE ARE TWO WAYS TO MODIFY PROGRAMMING OF THE V-SERIES OPL SIX (6) PREPROGRAMMED FORMULAS

Option 1: Programming can be accomplished manually using the machine controls or by connecting to the machine control using a PDA (personal digital assistant). For instructions on using a PDA with this washer control and software, please contact your local Dexter distributor. Please read below for manual programming instructions.

The keypad layout for the washer control is shown below.

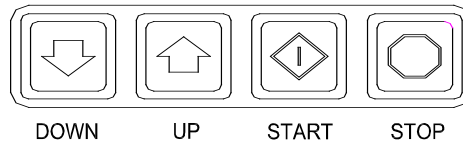

Option 2: Wash Cycle Manually Programming

1. Turn on the power to the washer.
2. Turn the Run/Program key to the Program position. Display will show "CO" and the "ADD BLEACH" will blink and will continue to blink during the programming mode.
3. Press the "DOWN" or "UP" buttons to select which cycle to alter. When the desired cycle number is displayed, press "START".
4. The display should now show a "b". The "b" and the cycle indicator lights indicate which bath is being selected to alter. Press the "UP" and "DOWN" buttons to select a bath to change and then press "START".

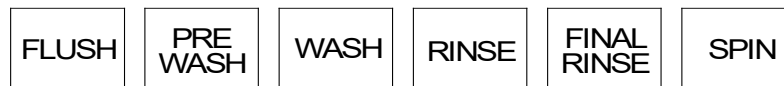

The indicator lights are shown above:

When "RINSE" is selected, "b r1" through "b r4" may be selected.
There may be multiple rinses that are indicated by br 1, br 2, br 3, and br 4

5. Each bath can be programmed with the following options. Use the "DOWN" and "UP" keys to select the desired setting and the "START" key to move to the next option.

To exit the programming of a bath, press the "STOP" button once and use the "UP" and "DOWN" keys select another bath. Press the "STOP" button again to select a different cycle to change. To end programming, turn the key to "RUN" position.

Rapid Advance Mode

To enter the Rapid Advance mode, turn the key CCW. The Rapid Advance setting is not marked next to the key, but turning the CCW until it stops selects this mode. The Rapid Advance mode can be entered from either the Idle mode or during the cycle. If the cycle has not yet started, press the "START" button. To rapid advance to the next step in the wash cycle, push both the "UP" and "START" buttons at the same time. The display will show an "Ad" (advance) in the display. The washer will advance to the next bath segment. The water will drain before the advance will occur and the time displayed may not be accurate.

- Notes:**
- The indicator lights will show to which segment the cycle has been advanced.
 - The cycle will continue in rapid advance mode even if the key is turned to "RUN" and/or removed.
 - Rapid advance cannot skip the final 1- minute tumble of the cycle, and the door lock may remain activated for up to 3 minutes after the cycle has been completed.
 - Chemical 120 volt signals will be lost after Rapid advance Mode has been activated until cycle resets. To exit the Rapid Advance mode, push and hold the STOP button.

Injection Source Details

The washer control may be programmed to send output signals for a chemical injection system. There is a separate terminal block for connection of the external injection signals. For the injection sources, program codes 0 through 6 are as shown in the table below. Injection signal will trigger a 120 volt reading at rear terminal block for approximately 5-10 seconds and will start to trigger at about 10-seconds after start of fill bath.

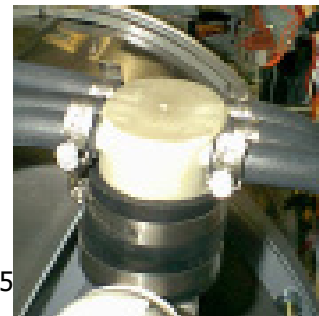
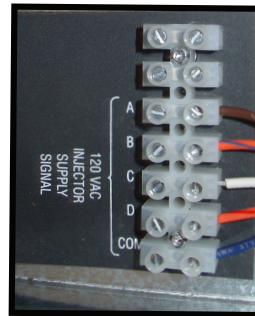

| Dexter Recommended Connections Circuits | Controller Programmed Signals | Injection Terminal Block |
|---|-------------------------------|--------------------------|
| Detergent | 1 | A |
| Bleach | 2 | B |
| Starch | 3 | C |
| Sour/Softener | 4 | D |
| | 5 | A and B |
| | 6 | C and D |
| | 0 | None |

NOTE: The Wash Cycle programming mode will automatically exit and return to the Idle mode if no buttons are pushed for one minute.



Section 4:

Trouble Shooting

Common Troubleshooting Solutions

| Symptom | Probable Cause | Suggested Remedy |
|-------------------------------------|------------------------------|--|
| Machine does not start | Power Supply | Check these areas: Circuit breakers, Voltage, Power leads, Power connections. Is front display LED showing a dollar amount. |
| | Door Switch | Check for continuity through door switch when door is closed. If no continuity, adjust or replace door switch. |
| | Control Breaker or Fuse | Check 1.5 amp (T-1200. uses 2.5amp) breaker or fuse for continuity. If no continuity, replace breaker or fuse. |
| | Control Transformer | Check voltage output from control transformer for 120VAC. If voltage is incorrect, replace transformer. |
| | Check PCB board | Check all wire connections for sure contacts. |
| | Check wiring between PCB | Check data cable phone type connectors unplug and VFD and replug with power removed. |
| | Check Relay PCB | Check all wire connections for sure contact. |
| | Check Door Solenoid | Check that 120 v power is at solenoid after start button is pushed. |
| Door does not lock | Check display for fault code | Does F1 show on the front of display. If yes follow tests described in fault code section. |
| | Door locking solenoid | Check to insure that solenoid is receiving 120VAC from main relay PCB. If it is, replace solenoid. |
| | Door Switch | Check for continuity through door latch switch when door closed. If no continuity, adjust or replace door switch. |
| Door will not open | Thermoactuator | Check to see if thermoactuator(s) and/or its mechanism is stuck or binding and not allowing the door lock solenoid to open. Check to be sure that the locking thermoactuator is not receiving 120VAC during the last 1 1/2 minutes of the cycle. Also check to see that the unlocking thermoactuator is receiving 120VAC during the last minute of the cycle. If the thermoactuators do not receive voltage at the correct times, change the timer. If the timing and voltage are correct, replace the thermoactuator. |
| Door will not open | Door Rod | Check to see that door rod from solenoid to lock ass'y is long enough to allow lock ass'y to disengage. If not, adjust rod. |
| | Door Lock Solenoid | Check that door lock solenoid is not stuck closed. If stuck, replace solenoid. |
| No hot water in detergent dispenser | Water Valve Coil | Check coil continuity at terminals and replace if no continuity. 120 V power only on for 20 second in wash bath. |
| | Water Inlet | Check water inlet screens for blockage and clean screens if necessary. |
| | Water | Check to insure that water is turned on and operating. |
| | P-20 Wire Harness | Check black & white harness. |

Common Troubleshooting Solutions

| Symptom | Probable Cause | Suggested Remedy |
|--|---|---|
| Hot water does not enter tub in wash | Water Valve Coil | Check coil continuity at terminals and replace if no continuity. Check for 120 V power from main relay PCB |
| | Water Inlet | Check water inlet screens for blockage and clean if necessary screens |
| | Water | Check to insure that water is turned on and operating. |
| | Blk or Wht wire at main controller | Check black or white wires at Molex plug on PCB at main controller and at relay PCB. |
| | Pressure Switch | Check pressure switch continuity between terminals . If no continuity, check pressure switch hose for obstruction. If hose okay, change pressure switch. |
| No cold water to tub in wash | Water Valve Coil | Check coil continuity at terminals and replace if no continuity. |
| | Water Inlet Screens | Check water inlet screens for blockage and clean if necessary. |
| | Water | Check to insure that water is turned on and operating. |
| | Blk or whit wire at controller and main relay PCB | Check black or white wires at Molex plug on PCB at main controller and at relay PCB. |
| | Pressure Switch | Check pressure switch continuity between terminal contacts. If no continuity, check pressure switch hose for obstruction. If hose okay, change pressure switch. |
| Water comes in but level does not rise | Drain Valve (open) | Check these areas • Drain valve blockage • Drain valve motor and gear train. If power but drain valve does not close, replace valve. • Power to the drain valve. If no power to drain valve, check (brn/yel) circuit for power. |
| | Blk or whit wire at controller | Check black and white wires at molex plug on main PCB controller and at main relay PCB |
| Water does not flush softener compartment. | Water Valve Coil | Check coil continuity at terminals and replace if no continuity. |
| | Water Inlet Screens | Check water inlet screens for blockage and clean if necessary. |
| | Water | Check to insure that water is turned on and operating. |
| Water does not flush softener compartment. | Pressure Switch | Check pressure switch continuity between terminals. If no continuity, check pressure switch hose for obstruction. If hose okay, change pressure switch. |
| Water level too high | Pressure Switch | Check for blockage in pressure switch hose. Check for pressure switch opening circuit across terminals . Replace switch if contacts do not open. |
| Water drains slowly | Drain System | Check hoses and drain valve for blockage. Clean of inadequate size. if necessary. Check building drains for blockage |

Common Troubleshooting Solutions

| Symptom | Probable Cause | Suggested Remedy |
|-------------------------------------|-------------------|--|
| Machine does not turn | VFD | Check VFD by removing inspection panel and record any numbers or letters displayed. If no display turn power off to machine at breaker for 2 minutes and turn power back on to reset. If still no display replace VFD |
| Machine tumbles in one direction | VFD | Remove inspection cover at rear and record in only numbers or letters displayed. See fault code section for more info. |
| | VFD | Inspect yellow enable wires from main relay PCB and at VFD |
| Excessive vibration | Mounting System | Check these areas: • Strength of mounting structure, concrete or base. • Mounting bolts may be loose and need tightening. |
| | Drive Belt | Worn drive belt can cause vibration and noise. |
| | Loading | Note: Small loads contribute to out of balance loading and increase vibration. |
| Machine does not spin | Pressure Switch | Check pressure switch for continuity across terminals #21 & #22 indicating pressure switch has reset to the empty position. If no continuity, change pressure switch. |
| Machine starts and does not operate | VFD | Check yellow enable wires from relay PCB P13 & motor P14 to VFD advances through cycle are connected. Check fault code on VFD before removing power from the drive. Check orange P-15 wire for signal from door switches. |
| Machine does not stop | Main PCB | Main PCB controls time cycle at end of cycle |
| | Braking Resistors | Check braking resistors for continuity. Verify ohms resistance by Molex. |
| Water leakage around loading door | Door Adjustment | Door may need adjustment due to abuse or wear. Check tightness around perimeter using a dollar bill. Adjust left to right tightness by shims at door lock or hinge side. It is important to center gasket to tub opening before tightening door to hinge bolts. Chalk may be used on tub front to show point of contact with tub. If gasket is deformed, worn, or damaged, replace. Refer to parts section for door gasket expander kit. |

Troubleshooting Machine Fault Errors

The following are descriptions of fault codes that will appear on the front of the washer. There is a chart format that shows what fault code that will be displayed at washer front. The codes displayed may or may not stop machine operation.
PLEASE NOTE: CHECK DRIVE FAULT CODE BEFORE POWERING MACHINE DOWN!

| Fault# | Description | Customer Action |
|-----------|---|---|
| F1 | The door failed to close and lock or The door failed to remain locked during the cycle. | Check VFD fault code before turning off. Check to hear if door solenoid engaged. Turn off the power to the washer. Check wire connections to door /lock switches. Check wire connections from switches to controller. Check P-4 wire connections at PCB controller. Adjust the door lock mechanism. (See service manual) |
| F2 | The washer tub does not fill with water within 7 minutes. The wash cycle will continue. The F 2 will flash three times, then wait for 30 seconds. The error will clear at the end of the cycle. | Turn off the power to the washer. Check the operation of the water valves. Check the incoming water pressure. Check for blocked or restricted water flow. Check to ensure the drain valve is functioning properly. This error will occur on 18# washers when water level is set for high (the pressure switch in 18# washer is only one level). |
| F3 | Memory error in controller. The memory checksum is wrong. | Check VFD fault code before turning off power. Try to clear the fault with the Palm. Try a soft Reset of the controller with the white button. If problem. Replace PCB controller. |
| F4 | Washer controller communication error | Check VFD fault code before turning off power. Try the data cable first. Move around cable and remove any side loading tension from data cable connector ends. Check connection P25/24/23 to P15. Turn power back on to the washer. If the problem returns, replace the PCB washer controller. |
| F5 | Pressure Switch error (only OPL) - when the high level sensor indicates full but the lower one indicates empty. The wash cycle will continue. The F 5 will flash three times, then wait for 30 seconds. The error will clear at the end of the cycle. | Check VFD fault code before turning off power. Check the pressure switch.(Ohm out contacts). Check pressure switch connections to ensure they are all making good contact. Check the Molex type harness connector to ensure no wire been pushed out of the Molex type housing that it is shorting or not connecting. |
| F6 | Wrong washer size for drive type. | Check VFD fault code before turning off power. If the controller was installed in a different size machine before being installed in this machine, a problem can occur. If someone has been doing repairs on the washer, check for the correct size drive. It can also be caused by pressure switch harness. Check to ensure the correct harness in installed. The control can be reset by holding program button on controller during startup (soft reset). Check orange wire at Molex connector on controller coming from pressure switch or replace pressure switch harness. |

| Fault# | Description | Customer Action |
|---------------|--|--|
| F7 | Wrong size drive installed | Check VFD fault code before turning off power. Check to ensure all the harnesses are properly connected to the controller. Check to ensure the VFD drive horsepower is proper for this size of washer. The control can be reset by holding program button on controller during startup (soft reset) Check orange wires at molex connector on controller coming from pressure switch. |
| F8 | The washer tub does not empty within 7 minutes. The wash cycle will continue. The F 8 will flash three times, then wait for 30 seconds. The error will clear at the end of the cycle. | Check VFD fault code before turning off power. Check to ensure the drain valve is operating properly (slow drain has potential to cause this code). Check to ensure the pressure switch tube is clear of any blockage, and the pressure switch is operating properly. Check the pressure switch harness. |
| F9 | The washer tub does not reach the spin target frequency within 150 seconds. The wash cycle will continue. The F9 will flash three times, then wait for 30 seconds. The error will clear at the end of the cycle. | Check VFD fault code before turning off power. Check to ensure the drain valve is operating properly (slow drain has potential to cause this code). Check to ensure the pressure switch tube is clear of any blockage, and the pressure switch is operating properly. Check the pressure switch harness. |
| F10 | After a spin the washer tub does not stop within 150 seconds. | Check VFD fault code before turning off power. Inspect the braking resistors and measure the resistance. Check connecting wiring from braking resistor to the drive mounted in the top of the washer. Reset the drive and try again. Possibly incorrectly programmed drive. |
| F11 | The drive size setting has changed. | Check VFD fault code before turning off power. Check to ensure all the harnesses are properly connected to the controller. Check to ensure the drive horsepower is proper for this size of washer. If no one has worked on machine very recently then PCB controller or VFD may need to be replaced. Do a soft reset before and after either VFD replaced. |
| F12 | Washer controller internal error | Check VFD fault code before turning off power. Turn off the power to the washer. Wait one to two minute. Turn on the power to the washer. If problem reappears, contact your Dexter Authorized Representative. |

| Fault# | Description | Customer Action |
|------------|---|---|
| F13 | The variable frequency drive (VFD) and the washer computer are not communicating. | <p>Check the data communication cable between the washer computer and the variable frequency drive (VFD).</p> <p>Step 1: Make sure the cable did not become unplugged during operation.</p> <p>Step 2: Make sure that the cable is not being pulled sideways at either the washer controller, or the VFD, plug end. If both ends of the communications cable are plugged in the washer computer and VFD and there is no tension on the communications cable pulling it from side to side, then replace the cable.</p> <p>Step 3: Inspect both female connection points at PCB controller and at VFD. These may need replacement if they cannot be reset.</p> |
| F14 | Over-current on the drive or motor. | <p>Step 1: Check to make sure the washer cylinder turns freely by hand. If it turns freely, continue to step 2. If it does not, remove the belt and see if the motor turns freely by hand. If the motor turns freely, then check for obstructions in the cylinder or check the bearings. If the motor does not turn freely, replace the motor.</p> <p>Step 2: Check the motor wires for a short circuit between leads. If there are motor leads that have conductors touching, separate them and insulate them. If the wires are broken, splice them together or replace the motor.</p> <p>Step 3: Check braking resistors to see if they measure the correct resistance. If a resistor does not measure the proper value, replace it.</p> |
| F15 | The variable frequency drive (VFD) senses that the internal voltage is too high. The source of the problem can originate from two different areas. Area 1: The input voltage can be too high, or there may be a high level of electrical noise. Area 2: The motor can be generating a voltage that is acting like an input to the VFD output motor terminals. | <p>Step 1: Measure the supply voltage to the VFD on the L1, L2 (or N), and L3 (if connected to three phase power). the supply voltage should be from 187 to 264 VAC or 108 to 132 VAC for a 120 VAC VFD. Also make sure the supply wires on L1, L2 (or N) and L3 (if connected to three phase power) are securely connected.</p> <p>Step 2: Check the braking resistor connections at the VFD. The terminal screws should be tight. Once of the braking resistor wires should be connected to terminal B2.</p> <p>Step 3: Measure each braking resistor separately to make sure they are the correct resistance. (200 for 1 and 2 Hp VFD and 160 for 3 Hp VFD).</p> <p>Step 4: If you have a 240 VAC, high leg voltage supply, try disconnecting the high leg. If this cures the problem, either leave the high leg disconnected, connect a transient voltage surge suppressor (with some form of filtering) at the voltage supply panel, connect a line choke on the high leg or install a VFD filter.</p> |

| Fault# | Description | Customer Action |
|---------------|--|---|
| F16 | The temperature sensor inside of the variable frequency drive detects that the internal temperature is too high. | Step 1: Make sure the cooling fins on the VFD heatsink and the ventilation louvers on the VFD cooling fan cover are clean. Step 2: Start a washer cycle and make sure the VFD cooling fan operates after the cylinder starts turning. |
| F17 | Overload of the drive or motor | (Check drive fault code before powering down). Check the washer motor to ensure it turns freely. Check the wiring for loose connections to the drive and motor. Measure the braking resistor values. Check for damaged motor wires. Check V-Belt tension and adjust to 1" deflection at center. Check braking resistors. |
| F18 | Ground Fault to the drive | Check VFD fault code before turning off power. Check the wiring connections to the drive and motor. Check the ground wiring of the drive, motor and incoming connection to ensure a proper ground is present. Check for damaged motor wires. |
| F19 | Low Voltage to the drive | Check VFD fault code before turning off power. Turn the power off to the washer. Check the wiring connections to the drive and motor. If no problem is observed, turn on power to the washer and test. (See Note) Measure the incoming line voltage. |
| F20 | Internal drive error | Check VFD fault code before turning off power. Turn the power off to the washer. Wait one minute. Turn the power on to the washer. If problem reappears, contact your Dexter representative. |
| F21 | Data error on communications between the controller and drive Internal drive error # 32. This error also has CEXX errors associated with it that are presented on the drive display. | The CE errors are communications errors. Data Cable noise can cause the majority of these errors. Check VFD fault code before turning off power. Check the data cable between the controller and the drive. Replace data cable if it appears damaged and fault appears again. Please note that this fault will occur if you turned main power off and on to quickly. (See Note below) |

Warning codes F22 - F28: These codes indicate that a component (VFD, relay PCB, injection relay PCB, water valve) has been replaced, added, or removed and you will need to soft reset the PCB controller board to reset the main controller to operate properly.

| Fault# | Description | Customer Action |
|---------------|---|------------------------|
| F22 | Future use | No action required |
| F23 | VFD has been replaced, disconnected, or removed. | Soft reset control. |
| F24 | Injection relay PCB has been removed or loose connection. | Soft reset control. |
| F25 | Optional water valve PCB removed or water valve has been replaced . | Soft reset control. |

| | | |
|---|--|---------------------|
| F26 | VFD unit has been added or loose connection. | Soft reset control. |
| F27 | Injection relay PCB has been added to machine or loose connection. | Soft reset control. |
| F28 | Optional water valve PCB has been added or loose connection | Soft reset control. |
| <p>Note: Whenever power is turned off to the washer, it must remain off for three minutes for drive to reset. The washer will not operate correctly if this is done improperly. This will allow most fault codes to reset that are displayed at washer front. A fault code F-13 or F-21 will appear on front display if this procedure has not been reset correctly. Note: Should a power loss occur during cycle and then power returns, P U S H will be displayed and customer must push a temperature selection button to continue the cycle.</p> | | |

Drive Motor Inverter Type Motor-Winding Resistance Chart

T650 C-Series Express Washer

| Motor | Winding | Wire # | Resistance | |
|--|----------------|---------------|-------------------|----------------|
| | | | Minimum | Maximum |
| T750 1ph or 3ph 60hzMain (wash & spin) | | T1 & T2 | 2.25 | 2.61 |
| Dexter #9376-319-001 | | T2 & T3 | 2.25 | 2.61 |
| Marathon # | | T1 & T3 | 2.25 | 2.61 |

T750 C-Series Express Washer

| Motor | Winding | Wire # | Resistance | |
|--|----------------|---------------|-------------------|----------------|
| | | | Minimum | Maximum |
| T750 1ph or 3ph 60hzMain (wash & spin) | | T1 & T2 | .944 | 1.097 |
| Dexter #9376-329-001 | | T2 & T3 | .944 | 1.097 |
| Marathon # | | T1 & T3 | .944 | 1.097 |

T950 C-Series Express Washer

| Motor | Winding | Wire # | Resistance | |
|--|----------------|---------------|-------------------|----------------|
| | | | Minimum | Maximum |
| T950 1ph or 3ph 60hzMain (wash & spin) | | T1 & T2 | .944 | 1.097 |
| Dexter #9376-329-001 | | T2 & T3 | .944 | 1.097 |
| Marathon # | | T1 & T3 | .944 | 1.097 |

T1450 C-Series Express Washer

| Motor | Winding | Wire # | Resistance | |
|--|----------------|---------------|-------------------|----------------|
| | | | Minimum | Maximum |
| 60lb 1ph or 3ph 60hzMain (wash & spin) | | T1 & T2 | .327 | |
| Dexter #9376-328-001 | | T2 & T3 | .327 | |
| Marathon | | T1 & T3 | .327 | |

NOTE: Resistance values are measured at the stator. Values at the end of the motor wiring harness may be slightly higher.

Variable Frequency Drive Control

Digital Readout Faults

| Fault# | Description | Customer Action |
|-------------|--|-----------------|
| CE1 | VFD received an illegal command. Possible controller problem | Reset drive. |
| CE2 | Illegal data address, VFD received an address not available to the controller. | Reset drive. |
| CE3 | Illegal data value received at VFD. Possible controller problem. | Reset drive. |
| CE4 | VFD unable to perform the requested action. Possible controller problem. | Reset drive. |
| CE6 | Time frame between commands is too short. Possible controller problem. | Reset drive. |
| CE9 | Internal checksum error. VFD problem. | Reset drive. |
| CE10 | Watch dog timer. Command not received from the controller every 6 seconds | Reset drive. |
| CE11 | Frame error. Possible Baud rate issues between VFD and controller | Reset drive. |
| CE12 | Command message is too short. Possible controller problem | Reset drive. |
| CE13 | Command message is too long. Possible controller problem | Reset drive. |
| CE14 | Command message includes unused characters. Possible controller problem. | Reset drive. |

Normal operation of the VFD: VFD display shows operating frequency first very quickly then changes to F0.0 at time power is returned. This will stay displayed until the VFD receives a command from main control PCB. (Pushing start button) A CE-10 fault will display at drive if improper communication between PCB and VFD has occurred.

Note: Resetting a fault code on front of washer: Turn the power off to machine (machine will need to remain off for up to three minutes).

SOFT RESET : is accomplished by pushing the white button located on the Main controller PCB board and simultaneously turning power on to machine. This will reset main controller to factory default settings.

Please record any modified information that has been inserted in memory before attempting to Soft Reset the PCB.

CE5, CE7 and CE8—Reserved by DELTA

Variable Frequency Drive Control

Digital Readout Faults

| Fault# | Description | Customer Action |
|-----------------|--------------------------------|--|
| OL or OU | Overload of the drive or motor | (Check drive fault code before powering down). Check the washer motor to ensure it turns freely. Check the wiring for loose connections to the drive and motor. Measure the braking resistor values. Check for damaged motor wires. Check V-Belt tension and adjust to 1" deflection at center. Check braking resistors. |
| GF | Ground Fault to the drive | Check VFD fault code before turning off power. Check the wiring connections to the drive and motor. Check the ground wiring of the drive, motor and incoming connection to ensure a proper ground is present. Check for damaged motor wires. |
| LU | Low Voltage to the drive | Check VFD fault code before turning off power. Turn the power off to the washer. Check the wiring connections to the drive and motor. If no problem is observed, turn on power to the washer and test. (See Note) Measure the incoming line voltage. |



Section 5:

Machine Service Procedures

Top Panel Removal Top Soap Dish

- Step 1:** Remove 4 screws that hold detergent dispenser to top panel. (for T750, T900, T950)
- Step 2:** Unlock top panel lock.
- Step 3:** Raise top panel, slide to the rear to release from back clips and lift off.

Top Panels Removal Front Soap Dish

- Step 1:** Unlock top panel locks.
- Step 2:** Raise front top panel, slide forward to release from rear top panel.
- Step 4:** Remove 5/16 bolt from hold down brackets, (rear top panel front edge to each side panel.
- Step 3:** Raise rear top panel, slide to the rear to release from back clips and lift off.

Front Panel Removal

- Step 1:** Remove 2 screws between front panel top and front (located behind control panel).
- Step 2:** Remove the two or four screws in the middle of the front panel.
- Step 3:** Pull panel out at the bottom to about a 45 degree angle to detach the top lip and remove.

Back Panel Removal

- Step 1:** Remove all screws holding back panel in position except the bottom row.
- Step 2:** The bottom row of screws are slotted and only need to be loosened and to lift off panel.

NOTE: The back panel is not only a safety requirement but also contributes to the rigidity of the cabinet.

Drain Valve Access

For access to drain valve, remove lower service panel. The drain valve is a ball type and is powered closed by the drain valve motor. It is mounted under the washer tub on the left side. It is spring loaded open. If power is interrupted to the washer, the motor releases the sealing ball, allowing the drive spring to open the valve. With the valve open, all water in the washer will drain out.

Drain Valve Cleaning

- Step 1:** Loosen the clamp on the tub hose at the drain valve end and remove the hose from the drain valve.
- Step 2:** Loosen the drain hose clamp on the back of the drain valve. Remove two drain valve mounting racket screws from the frame of the washer.
- Step 3:** **Disconnect red & black wire connection at clear connector.**
- Step 4:** Remove the drain valve and bracket assembly. Unplug the wiring after the drain valve is removed from the washer.

Detergent Dispenser (T-750, T-900, T-950)

Remove top panel to access dispenser. (see Removing Top Panel) Detergent is flushed from the front of the compartment and fabric softener is flushed from the back. There will be a small amount of water left in the fabric softener compartment after each use.

Vacuum Breaker (also called an air gap)

In the left rear of the cabinet is the vacuum breaker. It guides the water to the tub and dispenser and prevents a back flow of water.

Water Valves

Remove top panel to access water valves. (see Removing Top Panel) The two dual outlet water and/or single coil valves are mounted to the rear channel with two screws each. Always check inlet screens to be sure that they are clean. Disassembly requires the removal of two solenoid screws and three valve body screws. Below the solenoid coil is a solenoid guide, armature, armature spring and diaphragm. All valve parts are available individually or as a complete unit.

Door Lock Assembly Operation

After loading the clothing, the door should be closed and latched. The locking cam on the door contacts the latching switch actuator which closes the latching switch. The specified number of coins should now be added to start the washer. The solenoid pulls up on the locking pawl by use of a linkage rod. The locking pawl has two jobs. The first is to lock the door. This is accomplished by blocking the locking cam on the door so that it can't rotate to unlock. The second job is to close the two piggyback lock sensing switches. These switches control power to all of the controls. If the door unlocks for any reason, these two switches will stop the machine. When the door handle is 1/4 to 1/2 of an inch from its fully closed position, the latching switch should close. The two piggyback lock sensing switches should be open when the door is unlocked and should be closed when the door is locked.

Accessing the Door Lock Assembly

After removing the front panel and masking ring, the door lock assembly can now be accessed.

Adjustment for Door Lock Assembly

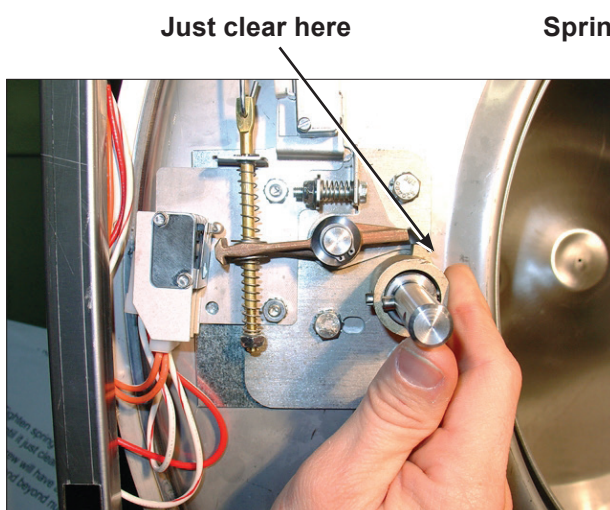

Step 1: Set door cam over pin. Here you can see the door cam away from the door lock assembly.

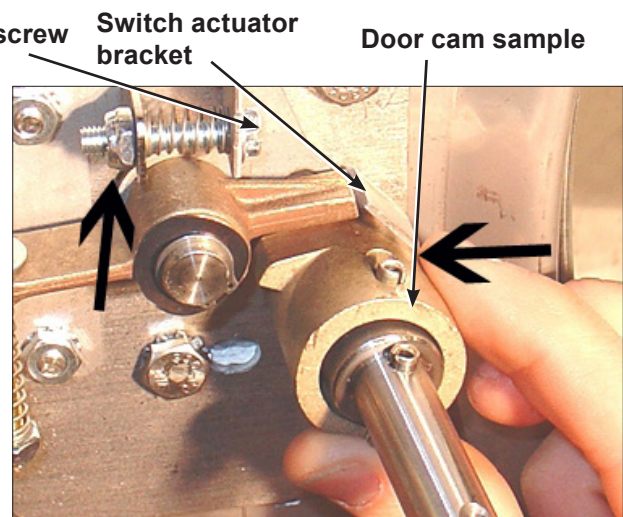

Step 2: Tighten spring screw on switch actuator bracket arm until it just clears cam OD. at base of door lock assembly.

Adjustment to this bracket usually is not necessary as next step is used more in field.

Flat blade screw on door switch latching

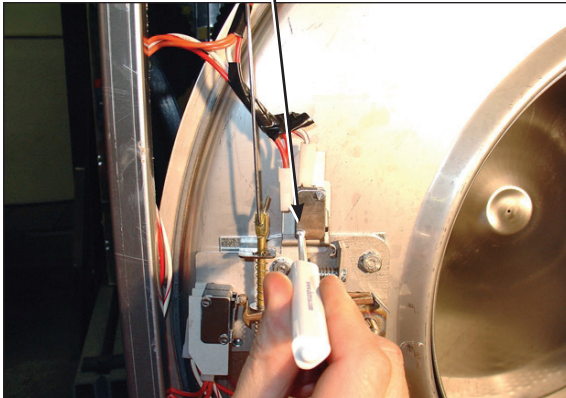

Step 3: With switch actuator bracket adjusted you will now need to adjust single switch by loosening 2 flat blade screws and allowing swivel of switch. Move switch towards above bracket until it actuates. Now tighten flat blade screws. Use a .040 thickness gauge to insert between bracket and switch and the switch should close and open again upon removal of thickness gauge.

Door cam check position

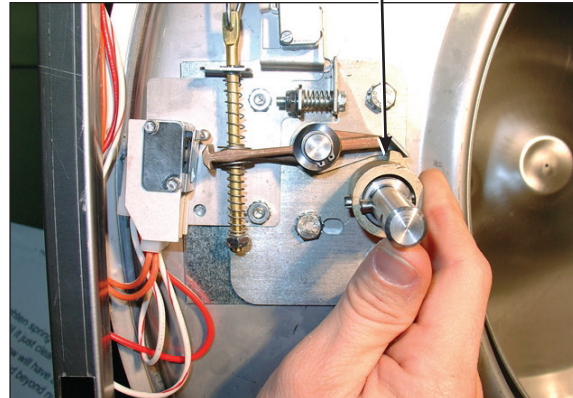

Step 4: Check for switch actuation at partial turn of cam as in operation above. Door handle goes from horizontal to six o'clock vertical.

Door lock rod Locking pawl blocking

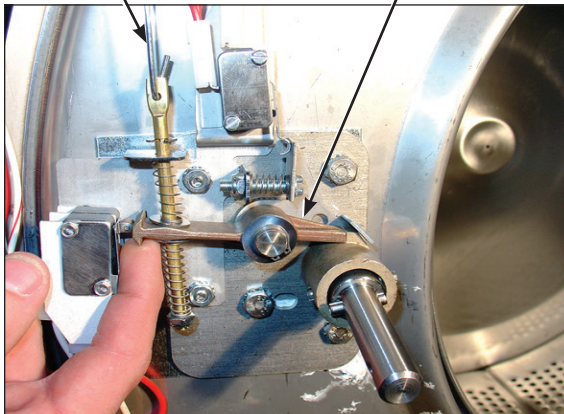

Step 5: Check that lock pawl arm swings to cam lobe to lock position.

Adjustment screw for (piggyback switches)

Top of flat end of locking pawl.

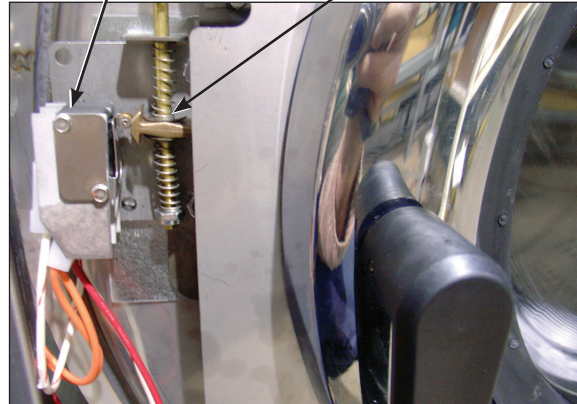

Step 6: The lock stacked switches (piggyback) must be adjusted as door lock solenoid pulls up on door rod and locking pawl is now blocking door cam from turning and is in full up position. The stacked switches (piggyback) have a single actuator arm and it must actuate when single actuator roller wheel rolls to flat side of locking pawl. You will also notice a .040 gap between actuator arm and switch bodies.

Note: Both stacked switches must operate together!

Adjusting the Loading Door

The door can be adjusted by changing the number of shims behind the door hinge and the door lock assembly. The vertical fit of the door to the tub can be altered by loosening the door hinge bolts and raising or lowering the door before retightening. It is important for the door to be centered on the tub front. By chalking the front of the tub and closing the door to transfer that line to the gasket, the centering can be evaluated. It is also important for door pressure to be similar around the door perimeter. Door pressure can be evaluated by inserting a dollar bill in several positions and tugging on it. See Parts Section for kit to increase door sealing pressure.

Loading Door Removal

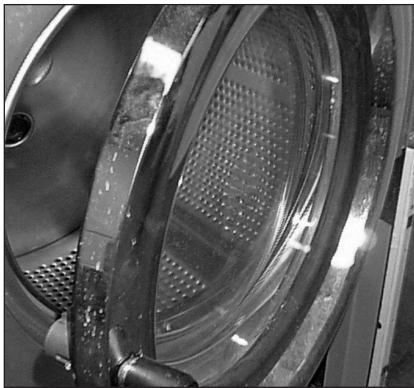

Step 1: Support door to prevent dropping.



Step 2: Remove 2 bolts holding the lower leaf hinge and set door off.

Loading Door Hinge Removal

Step 1: First remove loading door, front panel, and trim ring.



Step 2: Remove 3 screws holding door hinge. Shims may be present between hinge and tub front. The number may be increased or decreased to adjust right side door pressure.

NOTE:
Door hinge mounting bolts penetrate tub front and require silicone sealer applied to holes when reinstalling.

Loading Door Disassembly

Step 1: Remove the loading door as outlined above. Lay the door on a flat surface with the glass down

Step 2: While holding down on the door glass, lift up on the door ring and roll back the lip of the gasket with your fingers.

Step 3: Work all the way around the gasket and the glass is out.

Loading Door Reassembly

Step 1: Lay the door ring face down on a flat surface. Start the glass into one side of the door gasket.

Step 2: Use one hand underneath to push the gasket out and the other hand on the top pulling the gasket in place

Step 3: The front lip of the door gasket should be checked for proper seating.

Control Panel Name Plate Decal

The name plate on washer front is adhesive backed.

Control Panel Name Plate Removal

The name plate may be removed by simply peeling it off.

Re-Installation of Name Plate

Step 1: Remove any remaining glue from the control panel.

Step 2: Before removing the paper backing from the name plate, check fit to the control panel. The program push buttons are the locating guides.

Step 3: Remove the paper backing from the right side of the name plate, position it on the panel and press right end into place. Peel the backing from the left end and press into place.

Door Locking Gear Motor Assembly

The door locking gear motor is rotated shut with control voltage to lock the door and releases when voltage is removed. It is located in the left front corner of the washer. (Original locking solenoid models can be converted to the new assembly)

Thermoactuators

The thermoactuators are a safety device that keeps the door from immediately unlocking if power is lost while the machine is operating. They are mounted under the door locking solenoid.

Lock Thermoactuator

Control voltage is applied to the lock thermoactuator at the beginning of the cycle making it extend and block the door locking gear motor. This keeps the door locked for approximately two minutes after a power failure occurs. The lock thermoactuator does not delay the door opening at the end of a normal cycle.

Unlock Thermoactuator

To insure that the lock thermoactuator has retracted by the end of the cycle, one minute prior to the end of the cycle, the unlock thermoactuator is powered with control voltage making it extend and unblock the door locking gear motor.

Drive Belt Removal

Turn the drive pulley while applying pressure to the drive belt until it rolls off of the basket pulley first and then remove from the motor pulley. Be cautious not to drop the motor which could unhook the tension assembly.

Reverse this procedure for installation.

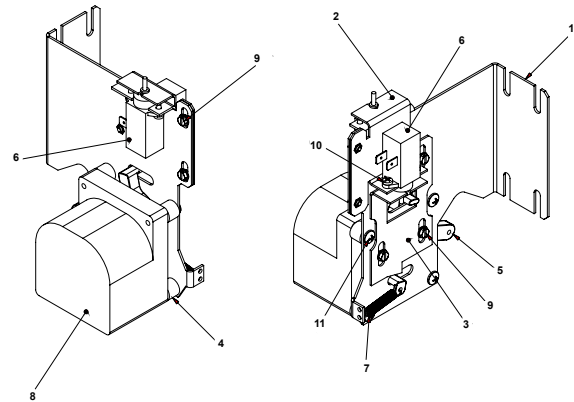

Door Lock Gear Motor

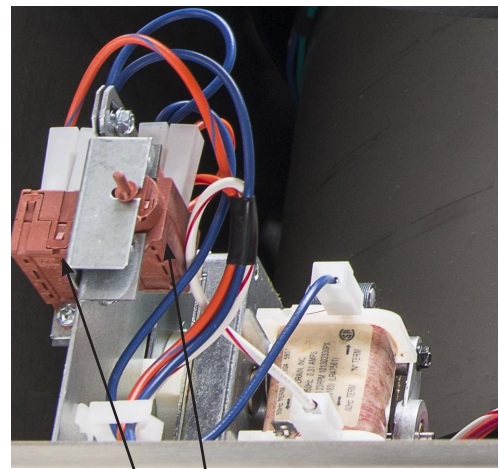

Thermoactuators



Drive Belt

Cylinder (basket)

- Step 1:** Remove the top panel as described previously.
- Step 2:** Remove lower service panel as described previously.
- Step 3:** Remove front panel as described previously.
- Step 4:** Remove masking ring as described previously.
- Step 5:** Remove door lock assembly. (Leave wires & pull rod in place)
- Step 6:** Remove clothes door.
- Step 7:** Remove tub front clamp ring.
- Step 8:** Remove tub front. Use a flat screw driver to pry the tub front loose.
- Step 9:** Remove the rear access panel.
- Step 10:** Remove the drive belts.
- Step 11:** Remove drive pulley. Remove 3 retaining screws. Insert (3) 3/8 16 x 2" screws into the threaded removal holes. Alternately tighten these screws evenly to pull the pulley off.
- Step 12:** Remove pulley hub. Drive a flat screw driver into the slot in the hub and pull it from the shaft.
- Step 13:** Install cylinder puller. (Snap On part #CJ-84-C) Be sure to thread a 5/8-11 NC bolt into the end of the cylinder shaft to protect the threads. Push the basket out.

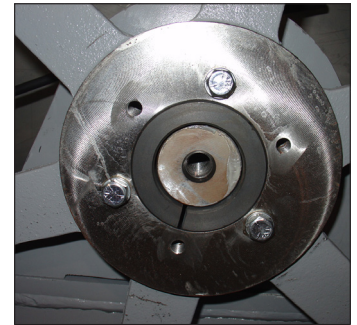
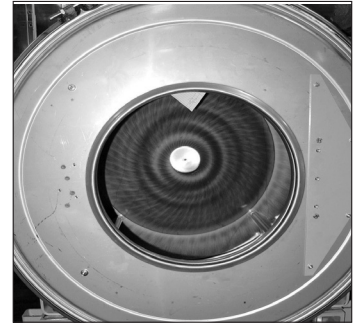

Bearing Housing Assembly

Removal

- Step 1: Remove cylinder from washer (see Cylinder (basket) removal).
- Step 2: Remove 6 7/16" tub back to bearing housing cap screws.
- Step 3: Remove 6 3/4" bearing housing to frame bolts.
- Step 4: Remove bearing housing from frame.
- Step 5: Remove the retaining ring next to the front bearing.
- Step 6: The bearings are pressed into the housing and must be pressed back out.

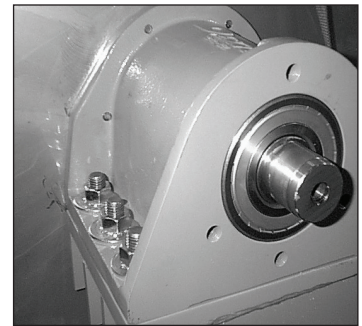

Reassembly

- Step 1: When installing new bearings into a bearing housing, first press the front (large) bearing into the housing until it bottoms and install the snap ring. With the bearing spacer in place, press the rear bearing in until the spacer is snug between the two bearings.

NOTE: If the tub-back water-seal mating ring has been moved it must be cleaned and resealed

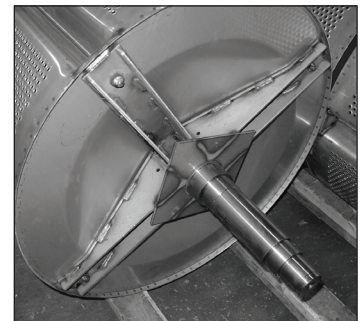

Water Seals

Replacement

- Step 1:** Remove cylinder from washer (see Cylinder (basket) removal).
- Step 2:** Remove water seals from the seal mounting plate on the cylinder shaft. These are removed with your fingers.
- Step 3:** The primary and secondary seals that mount on the sealing ring may be slid over the shaft and seated on the metal sealing ring with your fingers. In the unlikely event that the metal ring that mounts these sealing rings were to be damaged or moved, a new one would need to be pressed on. The seal mounting ring must be pushed against the stop on the shaft. After installing the seals, lubricate the faces of the seals with silicone grease.
- Step 4:** Install cylinder (see Cylinder (basket) reassembly).

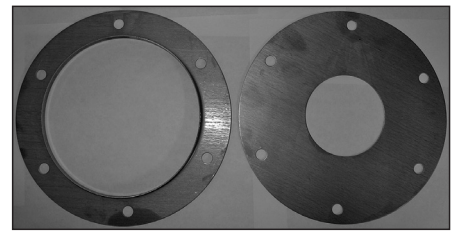

Guard Ring & Mating Ring

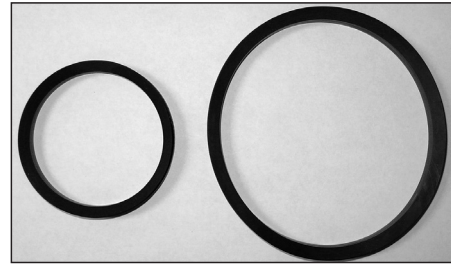

Seals

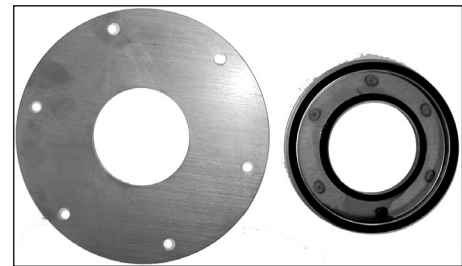

Mating Ring & Mounting Ring

Outer Tub

Removal

- Step 1:** The outer tub can easily be removed when the tub front, cylinder and bearing housing has been removed as outlined previously.
- Step 2:** At that point the only attachments to the chassis are the two front strap mounting bolts.

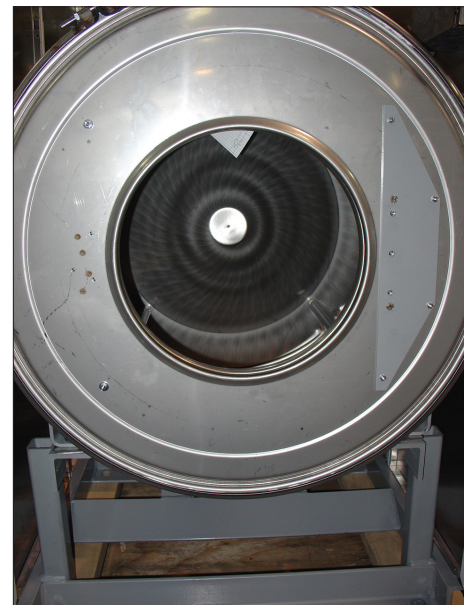

Reassembly of the Cylinder

- Step 1:** Use the hub of the drive pulley, a stack of 5/8" flat washers and a 3" long 5/8" bolt to pull the cylinder shaft through the bearings. After the 3" bolt a 2" long bolt will be required to finish pulling the cylinder shaft through.
- Step 2:** Remove the 1/2" bolt and nut from the top of the outer tub clamping band.
- Step 3:** Install Dexter Tool part # 8545-056-001 on the back of the outer tub to adjust tub front to cylinder clearance. Thread 5/8" bolt through tool and into cylinder shaft. Push the outer tub forward 1/4" to 1/2" with tool 8545-056-001 by tightening the 5/8" bolt. This will ease the installation of the outer tub front.
- Step 4:** Clean the silicone rubber off the tub front and the outer tub.
- Step 5:** Install new bead of silicone rubber on tub front.
- Step 6:** Install tub front.
- Step 6A:** Align hole in top of tub front with notch in top of outer tub.
- Step 6B:** Use 4-6 #11R vise grip clamps to hold tub front to outer tub. A rubber mallet may be needed to properly seat the tub front into the outer tub.
- Step 6C:** Install tub front gasket around outer edge of tub front and outer tub flange. The opening should be centered at the top.
- Step 6D:** Remove vise grips. The tub front gasket will hold the tub front in place.
- Step 7:** Install tub front clamp ring and tighten. Tap around the clamp ring with a rubber mallet to seat the ring and gasket while tightening the clamp ring bolt.
- Step 8:** Adjust clearance between the outer tub front and the front lip of the cylinder to 5/16".
- Step 9:** Tighten the outer tub clamping band.
- Step 10:** If necessary, the outer tub may be adjusted up or down and side to side with the 2 bolts that fasten the bottom of the outer tub clamping band to the frame.
- Step 11:** Remove Dexter Tool part 8545-056-001 from the back of the outer tub.
- Step 12:** Install drive pulley.
- Step 12A:** Install hub on cylinder shaft.
- Step 12B:** Hold hub against rear bearing with 5/8" bolt and flat washer in end of cylinder shaft.
- Step 12C:** Line up 3 unthreaded holes in pulley with the 3 threaded holes in hub.
- Step 12D:** Insert 3 pulley bolts and tighten evenly alternating bolts to 30ft/lbs.
- NOTE:** Overtightening or uneven tightening can break drive pulley.
- Step 13:** Install drive belts & back panel.
- Step 14:** Install door lock. All mounting holes should be sealed with silicone rubber.
- Step 15:** Install door, masking ring, front panel, lower service panel and top.

T-650 Bolt Torque Chart

| Bolt Size | Where Used | Torque |
|-------------------|---|----------------|
| 1/2"x 1 1/4" bolt | Tub End of Bearing Hsing. 9545-017-009 | 70-110 ft/lbs |
| 5/8"x 1 1/2" bolt | Tub End of Bearing Hsing. 9545-060-001 | 120-150 ft/lbs |
| 1/2"x 1 1/4" bolt | Mtg. of Tub to Cradle Asy. 9545-017-009 | 70-110 ft/lbs |
| 5/8"x 2 1/2" bolt | Mtg. of Tub to Cradle Asy. 9545-060-001 | 120-150 ft/lbs |
| 3/8"x 1 1/2" bolt | Tub Back Ring to Tub Back 9545-029-003 | 45-80 ft/lbs |

T-750 Bolt Torque Chart

| Bolt Size | Where Used | Torque |
|-------------------|---|----------------|
| 1/2"x 1 1/4" bolt | Tub End of Bearing Hsing. 9545-017-009 | 70-110 ft/lbs |
| 5/8"x 1 1/2" bolt | Tub End of Bearing Hsing. 9545-060-001 | 120-150 ft/lbs |
| 1/2"x 1 1/4" bolt | Mtg. of Tub to Cradle Asy. 9545-017-009 | 70-110 ft/lbs |
| 5/8"x 2 1/2" bolt | Mtg. of Tub to Cradle Asy. 9545-060-001 | 120-150 ft/lbs |
| 3/8"x 1 1/2" bolt | Tub Back Ring to Tub Back 9545-029-003 | 45-80 ft/lbs |

T-950 Bolt Torque Chart

| Bolt Size | Where Used | Torque |
|---------------------------|----------------------------------|----------------|
| 7/16" Stainless Cap Screw | Outer Tub to Bearing Housing | 60-80 ft/lbs |
| 3/4" Bolt | Bearing Housing to Frame | 200-300 ft/lbs |
| 1/2" Bolt | Outer Tub Clamping Band to Frame | 70-110 ft/lbs |
| 1/2" Bolt | Outer Tub Clamping Band - Top | 30-40 ft/lbs |
| 3/8" Cap Bolt | Driven Pulley to Hub | 28-32 ft/lbs |

T-1450 Bolt Torque Chart

| Bolt Size | Where Used | Torque |
|---------------------------|----------------------------------|----------------|
| 7/16" Stainless Cap Screw | Outer Tub to Bearing Housing | 60-80 ft/lbs |
| 7/8" Bolt | Bearing Housing to Frame | 600-650 ft/lbs |
| 1/2" Bolt | Outer Tub Clamping Ears to Frame | 70-110 ft/lbs |
| 3/8" Cap Bolt | Driven Pulley to Hub | 28-32 ft/lbs |



Section 6:

Service Electrical Components

Control Mounting Trough

Remove top panel to access control trough. (see Removing Top Panel) It sets on the right side of the machine and holds the control PCB's, transformers, and pressure switch.

Main Data Communication Cable

Goes between front PCB board and Variable Frequency Drive unit mounted center rear of machine. It has telephone type connectors at each end and is inserted at Controller PCB and the Variable Frequency Drive.

Circuit Breaker/Fuse

The fuse (optional circuit breaker) mounts to the rear channel. It carries all of the controls in the machine but does not include the motor. To reset the circuit breaker just push in the button. If you have a fuse then remove fuseholder and fuse and replace with a 1 1/2 amp fast blow type fuse.



Fuse Location

Main Control Printed Circuit Board

Please be sure to be grounded to machine before removal of this board from machine. PC board mounted vertically behind front control panel. Remove hold down nuts in 4 corners and 1 at bottom center.

PCB Transformer Step-down

Small transformer mounted at front of control trough that is powered with 120 VAC primary and two secondary outputs of 2.3 VAC and 24-27 VAC.

Controls Transformer

This transformer is mounted at the back of the control trough and steps a range of 208 to 240 volts down to 120 volts for the controls. There are two terminals on the controls transformer for incoming power. One terminal tap is marked for 208 volts use this tap for measured voltage of 200 volts - 215 volts. and the other tap is marked 230 volts for 216 volts - 240 volts. Note: All washers have a controls transformer. Always check the incoming voltage and use the appropriate transformer terminal when installing ALL washers.

Main Relay Printed Circuit Board

Please be sure to be grounded to machine before removal of this board. PCB mounting horizontal in control trough towards front of machine. Remove 4 mounting nuts.

LED Printed Circuit Board Temperature & Start Display/Push-Button

The selector switch is mounted in the center of the control panel and is held in place with five nuts. It allows the selection of hot, warm or cold water temperatures. Note: Do not over tighten on reinstallation as the switch can be damaged, stay pushed in and will cause erratic displays.

Add-Bleach LED

This LED light indicates to the user the correct time to add bleach. This LED is polarity sensitive and must be connected correctly.

Pressure Switch Caution (Not recommended by Factory!) Changing Factory preset adjustment voids all factory water usage specifications.

The pressure switch sets the water level in the washer. As the water level rises, it compresses the air in the pressure switch hose. When the washer reaches the desired water level, the compressed air in the pressure switch hose opens the contacts in the switch, shutting off the water. When at the empty level, the pressure switch contacts are closed allowing the machine to either spin or fill with water. The 1/4" screw in the middle of the switch adjusts the water level. Counter clockwise will lower the water level, and clockwise will increase the water level. Before making any adjustments of the pressure switch, drain the tub and blow the hose clear of possible water bubbles which can cause erratic pressure switch operation.

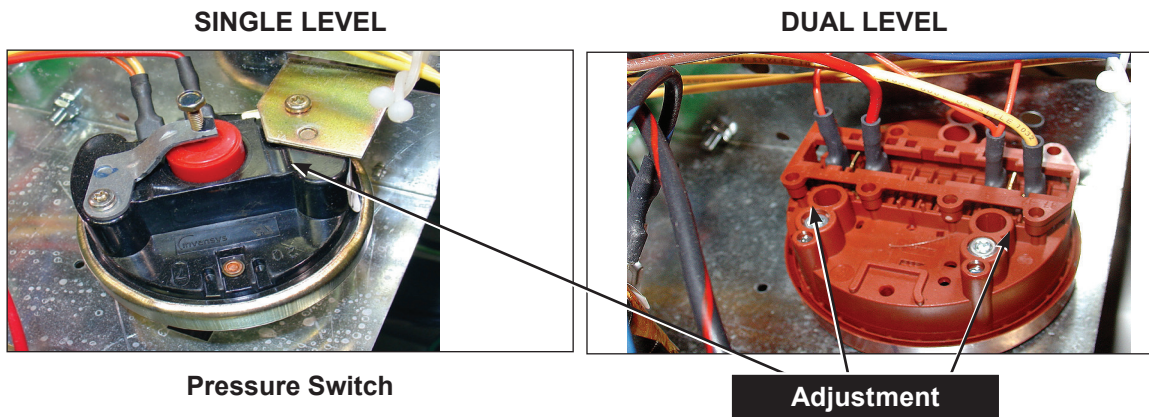

Mechanical Pressure switch VS Pressure Sensor

The Drawing below represents the Mechanical Pressure switch and wiring connections. After serial number W1.15244.001 all washers were converted to the electronic pressure sensor 9732-315-001. If desired previous C-series machines can be upgraded to the electronic pressure sensor with Kit 9732-314-001, Kit includes pressure sensor, hold downs, transformer, and wires. The Electronic pressure sensor wiring configuration is represented in the Diagrams and Schematics in this manual.

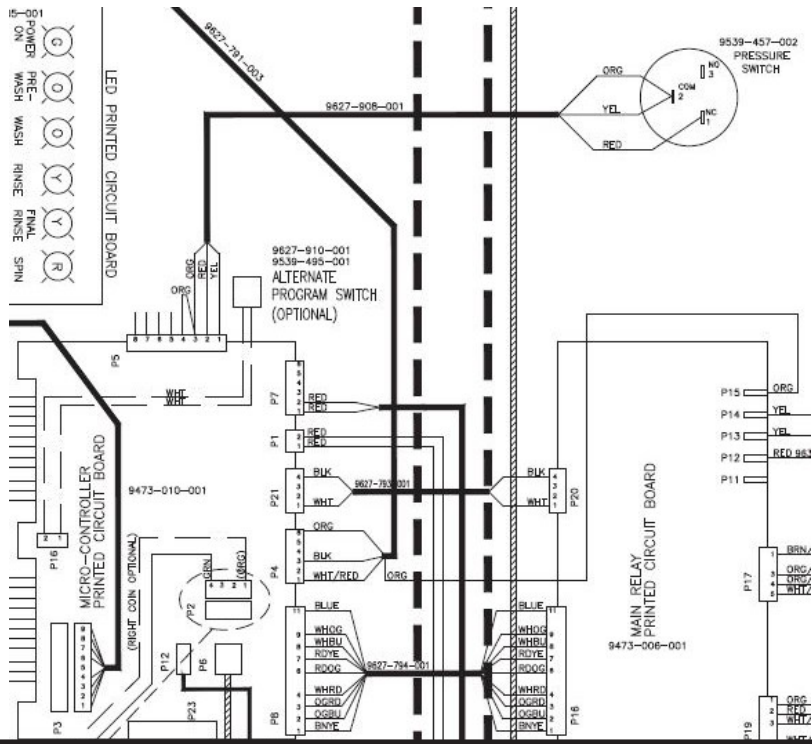

Electronic Pressure Sensor

The Electronic Pressure Sensor comes standard on all models Starting September, 1st 2015. Machines manufactured before this date can be upgraded with Kit 9732-213-001. The Pressure sensor is adjustable. The Factory settings chart will let you know the starting values for each machine and by following the Switch position chart you can adjust the water levels in 1/4 inch increments from that starting value.

Factory Settings:



| Model | Vended | | On-Premise | |
|-----------|------------------------|----------------------|------------------------|-------------------------|
| | Switch #1 Efficient | Switch #2 Classic | Switch #1 Low Level | Switch #2 High Level |
| T-300 | 5.25 | 7.00 | 6.00 | 6.75 |
| T-350 | 5.25 | 6.25 | 6.00 | 6.75 |
| T-400 | 7.00 | 9.00 | 8.00 | 11.00 |
| T-450 | 6.00 | 6.25 | 6.00 | 8.50 |
| T-450 SWD | 5.00 | 7.00 | 6.00 | 8.50 |
| T-600 | 7.25 | 9.25 | 8.00 | 11.00 |
| T-650 | 6.50 | 8.25 | 8.00 | 11.00 |
| T-750 | 6.00 | 7.50 | 6.00 | 8.75 |
| T-900 | 6.00 | 7.50 | 6.00 | 8.75 |
| T-950 | 6.00 | 7.50 | 6.00 | 8.75 |
| T-1200 | 6.00 | 7.50 | 6.00 | 8.75 |
| T-1450 | 6.75 | 7.00 | 6.75 | 9.50 |

Switch Positions:

| Depth (in): | Pos 1 | Pos 2 | Pos 3 | Pos 4 | Pos 5 | Pos 6 |
|-------------|-------|-------|-------|-------|-------|-------|
| 5.00 | | | | | | |
| 5.25 | on | | | | | |
| 5.50 | | on | | | | |
| 5.75 | on | on | | | | |
| 6.00 | | | on | | | |
| 6.25 | on | | on | | | |
| 6.50 | | on | on | | | |
| 6.75 | on | on | on | | | |
| 7.00 | | | | on | | |
| 7.25 | on | | | on | | |
| 7.50 | | on | | on | | |
| 7.75 | on | on | | on | | |
| 8.00 | | | on | on | | |
| 8.25 | on | | on | on | | |
| 8.50 | | on | on | on | | |
| 8.75 | on | on | on | on | | |
| 9.00 | | | | | on | |
| 9.25 | on | | | | on | |
| 9.50 | | on | | | on | |
| 9.75 | on | on | | | on | |
| 10.00 | | | on | | on | |
| 10.25 | on | | on | | on | |
| 10.50 | | on | on | | on | |
| 10.75 | on | on | on | | on | |
| 11.00 | | | | on | on | |
| 11.25 | on | | | on | on | |
| 11.50 | | on | | on | on | |
| 11.75 | on | on | | on | on | |
| 12.00 | | | on | on | on | |
| 12.25 | on | | on | on | on | |
| 12.50 | | on | on | on | on | |
| 12.75 | on | on | on | on | on | |
| 13.00 | | | | | | on |
| 13.25 | on | | | | | on |
| 13.50 | | on | | | | on |
| 13.75 | on | on | | | | on |
| 14.00 | | | on | | | on |
| 14.25 | on | | on | | | on |
| 14.50 | | on | on | | | on |
| 14.75 | on | on | on | | | on |
| 15.00 | | | | on | | on |

Power Connection Terminal Block

This terminal block sets at the very back of the control trough. Incoming power to the washer should connect here. (see Electrical under Installation and Operation Section for exact connections)

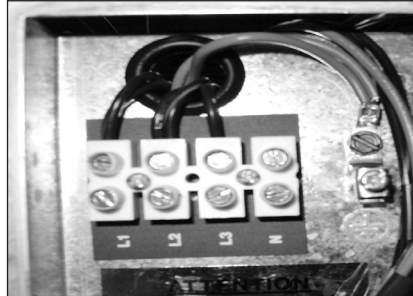

Rear

Delta Variable Frequency Drive:

Main power is connected to terminals L1, L2, and L3 on the Delta drive. If the washer is connected to a three phase source, there should be voltage present on all three terminals. If the washer is connected to single phase power, there should be voltage present on terminals.

The voltage should measure 208 Volts to 240 Volts A.C. between phases and connected to if connected to three phase). There is a tolerance of + 10% on the mains voltage (187 Volts to 264 Volts).

Delta VFD Motor Leads:

The wires from the motor are connected to terminals T1, T2, and T3. Since this drive uses pulse width modulation, an accurate current or voltage reading is not possible. Although an accurate current reading is not possible, a balanced current reading should be present while the motor is running.

Delta VFD Dynamic Braking Resistors:

Two, 160 Ohm or 200 Ohm braking resistors (Please check your washer model parts requirements and quantities), are connected in parallel and attached to the drive at terminals B1 and B2. These resistors allow voltage, which is generated by the motor when decelerating, to be dissipated. They will become hot while the motor is slowing down, so care should be taken so as not to come in contact with them. This will prevent an electrical shock and/or a physical burn.

Delta VFD Cooling Fan:

There is a cooling fan attached to the bottom of the Delta drive. This fan will operate when the internal temperature of the drive reaches a predetermined level, the same way the radiator fan in a newer car operates. THE FAN CAN OPERATE ANYTIME POWER IS APPLIED TO THE DRIVE! Remove power to the drive if work is required around the fan.

MAXIMUM SPIN SPEED ADJUSTMENT:

If desired, the washer can be adjusted to limit the maximum extract spin speed for all wash cycles. To make this adjustment, a jumper wire must either be installed or removed on the Variable Frequency Drive (VFD), depending on the washer model and desired speed. This Dexter jumper part number 8220-057-036 (qty. 1) is factory supplied on terminal points "10V" and "RC". Remove this jumper to make new jumper connections if necessary. Refer to Error! Reference source not found. for the approximate location of the control terminations on the Variable Frequency Drive (VFD) and Error! Reference source not found. for appropriate jumper connection points indicated with an "X" for the desired maximum spin speed setting. If no adjustment to default spin speed is desired, do not remove or add any wires on VFD.

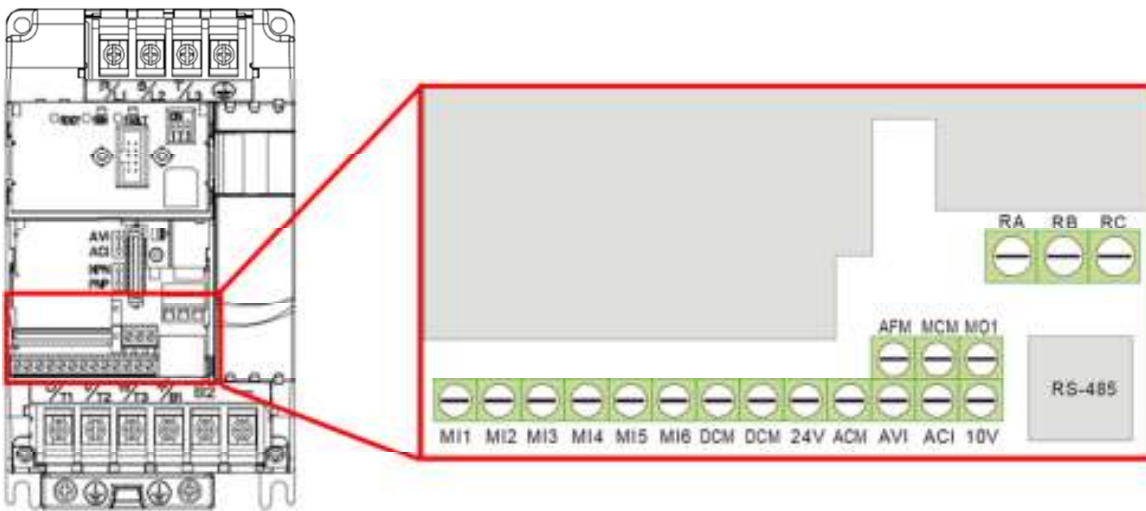

Control Terminations on Variable Frequency Drive

| V Series Washer Model | Max Spin Speed | Jumper Terminal Locations on Variable Frequency Drive (VFD) | | | | | | | | | | | | | |
|--|----------------|---|-----|-----|-----|-----|-----|------------|-------------|-----|-----|-----|-----|-----|-----|
| | | MI1 | MI2 | MI3 | MI4 | MI5 | MI6 | DCM (Left) | DCM (Right) | 24V | ACM | AVI | ACI | 10V | M01 |
| T-300, T-400, T-600, T-900, T-1200 | 60 G | | | | | | | | | | | | X | | X |
| | 80 G | | | | X | | | X | | | | | | | |
| | 100 G | Default Setting (No Jumper Required) | | | | | | | | | | | | | |
| T-350, T-450, T-750 | 60 G | | | | | | | | | | | | X | | X |
| | 100 G | | | | X | | | X | | | | | | | |
| | 140 G | | | | | X | | X | | | | | | | |
| | 200 G | Default Setting (No Jumper Required) | | | | | | | | | | | | | |
| T-950, T-1450 | 100 G | | | | | | | | | | | | X | | X |
| | 140 G | REMOVE Brown Jumper between MI5/M01 | | | | | | | | | | | | | |
| | 200 G | Default Setting (With Factory Installed Brown Jumper) | | | | | | | | | | | | | |

Spin Speed Adjustment Jumper Locations



Section 7:

Electrical Wiring Diagrams & Schematics

Electrical Path Circuit Schematics

Start Circuit

Power travels into the machine on L1 & L2 & (L3) (if 3 phase used). 208- 240VAC goes to a Control Transformer (must be checked at start -up to coincide with machine operating voltage) that steps the voltage down to 115VAC for the controls. 115VAC then travels from the transformer out on [X-1 red wire to the (fuse)] or [X-1 blk/red wire] to TB-4 then to the red wire to the fuse, (fuse in fuseholder). X-2 Blk/ blu wire is the neutral side of the transformer.

From the Fuse holder, 115VAC travels on the red wire to the #5 terminal on the terminal strip and then on the black wire to the Step-Down Transformer where it is stepped down to 2.3 VAC and 24 VAC that proceeds to the P 7 connection to power the micro-controller PCB. The Door must be closed to satisfy the door closed switch mounted on masking ring at front door. With data going out from front main PCB on the black wire through door closed switch and red wire out of door closed switch and over to door latched switch to await start button being pressed. Main PCB is satisfied and a 5 VDC signal is sent out of P4 connection on the white/red to the S1 door switch. With the S1 door switch closed 5 VDC is now on the red wire at the P4 connector of the micro-controlled PCB and a 115VAC signal will go to the Door Lock Solenoid from the P17 connector of the Main Relay PCB on the white/red wire. The Door Lock Solenoid pulls in, locking the door and closing the S2 and S3 Switches. The S2 Switch is a backup to the S1 Switch so that the adjustment on S1 isn't as critical. The S3 Switch provides 5 VDC on the org. wire back to P4 connector at micro-controlled PCB and P15 connector at the main relay PCB to know the loading door is closed and locked. Org. wire @ P15 turns on the enable to the drive to allow motion. With no signal on P15 (org. wire) there will be no motion of the tub. The black wire and white wire between Front controller PCB P21 and the main relay PCB P 20 is where door lock data is supplied to indicate door closed and locked to relay PCB and allows 120 volts to pass through relays to drain valve and water valves. The blue wire from the terminal strip will provide the 115 VAC neutral for solenoid, thermoactuators and all valves and the white wire from the terminal to the step down transformer.

Fill Circuit-Warm

S1, S2, and S3 Door Switches are now closed . The green On LED and the Door Lock Solenoid (discussed in Start Circuit) will remain on throughout the cycle. The Lock Thermoactuator receives 115VAC on orange/blue from P17 on main relay PCB and will alternate open and closed keeping the Lock Thermoactuator activated until 1 1/2 minutes before the end of the cycle. At this point the contact opens and removes power to the Lock Thermoactuator. The micro-controlled PCB also sends a signal to the main relay PCB and out through P17. The brown/yellow wire from P17 at main relay PCB supplies 115VAC to Drain valve which closes the valve. The reversing operation which will alternately provide the direction of tumble for the wash basket will be given commands to the VFD through the data cables at P6 micro-controlled PCB. The Prewash or Wash LED will illuminate at this time powered through the white wires from the micro-control PCB P3 to LED printed circuit board.

Now with a cycle previously; we'll use Normal Wash; the washer fills the tub through the back of the machine with either one or both the C1 Cold and H1 Hot Water Valves. At the beginning of the wash cycle bath only after a 90 sec. delay, the detergent dispenser flushes the detergent into the tub for 20 sec.. This is accomplished when 120VAC travels through the red/orange wire to the H2 Hot Water Valve Solenoid. As the washer fills with water, the Wash Basket will tumble one direction for 12 seconds, pause, and then reverse direction for 12 seconds. 120VAC goes through the P19 connection of main relay PCB on wht/ brn to the C1 cold water valve and the red/yellow wire to the H1 hot water valve if programmed. When the water reaches the predetermined level the Pressure Switch moves switch contacts to the full position and shuts voltage off to the both water valves. Between red wire from P5 micro-controlled PCB on pressure switch contact and yellow and orange wire from P5 micro-controlled PCB at other pressure switch contact a 5 VDC reading will open.

Wash Circuit

As the washer fills the tub through the back of the machine with either one or both the C1 Cold and H1 Hot Water Valves, the Wash Basket will tumble one direction for 12 seconds, pause, and then reverse direction for 12 seconds. This is accomplished through the use of a variable frequency drive. The time of the bath is programmable up 15 minutes per bath used.

Drain, Rinse 1 - 4, & Final Rinse Circuit

When the bath ends the micro-controller PCB removes 115 VAC power from brn/yel coming from main relay PCB at P17 to the Drain Valve. The normally-open spring-loaded Drain Valve opens and empties the tub. For Rinse 1 & 2, the Rinse LED will illuminate. The rinse water temperatures are programmable and will fill as above. For the Final Rinse, the Final Rinse LED will illuminate. These water temperatures are programmable also and will fill as described above. Also the softener dispenser will flush cold water from C2 cold water valve solenoid at beginning of final rinse bath for 20 sec..

Extract Circuit

The Spin LED will illuminate and the washer controller PCB sends a signal to the Variable frequency drive via the data cable at P6 to VFD RJ-11. The rotation as viewed from front during spin will be CCW except for the 18 lb washer it will spin CW. The motor is a 3 phase 230 VAC type motor for all models .

Thermoactuator and Shake Out Circuit

The Lock Thermoactuator loses power and opens 1 1/2 minutes before the end of the cycle . This allows the Thermoactuator time to retract by the end of the cycle. To insure that the Lock Thermoactuator has retracted by the end of the cycle, 1 minute prior to the end of the cycle, the Unlock Thermoactuator is powered with 115VAC through the org/red wire from P17 at main relay PCB. The basket will come to a stop from extract speed with the assistance of dynamic braking resistors wired in parallel to the variable frequency drive. The washer will then tumble for 45 seconds to let the clothes shake loose and then stop.

End of Cycle Circuit

The machine is now stopped and does 2 things: 1. The beeper will signal for 5 seconds letting the user know that it is the end of the cycle. 2. The micro-controlled PCB resets and display will reset when door is opened and it is now ready to run again.

| Bath | Bath Cycle Time (min.) | Water Temp. | Water Level | Delay Fill | Spin Time (min.) | Injection Source |
|-------------|-------------------------------|--------------------|--------------------|-------------------|-------------------------|-------------------------|
| Flush | 3 | CH | HI | d | | |
| Prewash | 2 | CH | HI | d | | |
| Wash | 7 | HH | LO | d | 1 | #1(Detergent) |
| Rinse 1 | 7 | HH | LO | d | 2 | #2 (Bleach) |
| Rinse 2 | 2 | CH | HI | d | 1 | |
| Rinse 3 | 2 | CH | HI | d | | |
| Rinse 4 | | | | | | |
| Final Rinse | 4 | CH | LO | d | 4 | #4 (Sour/Soft) |

WN0650XA-12 Schematic

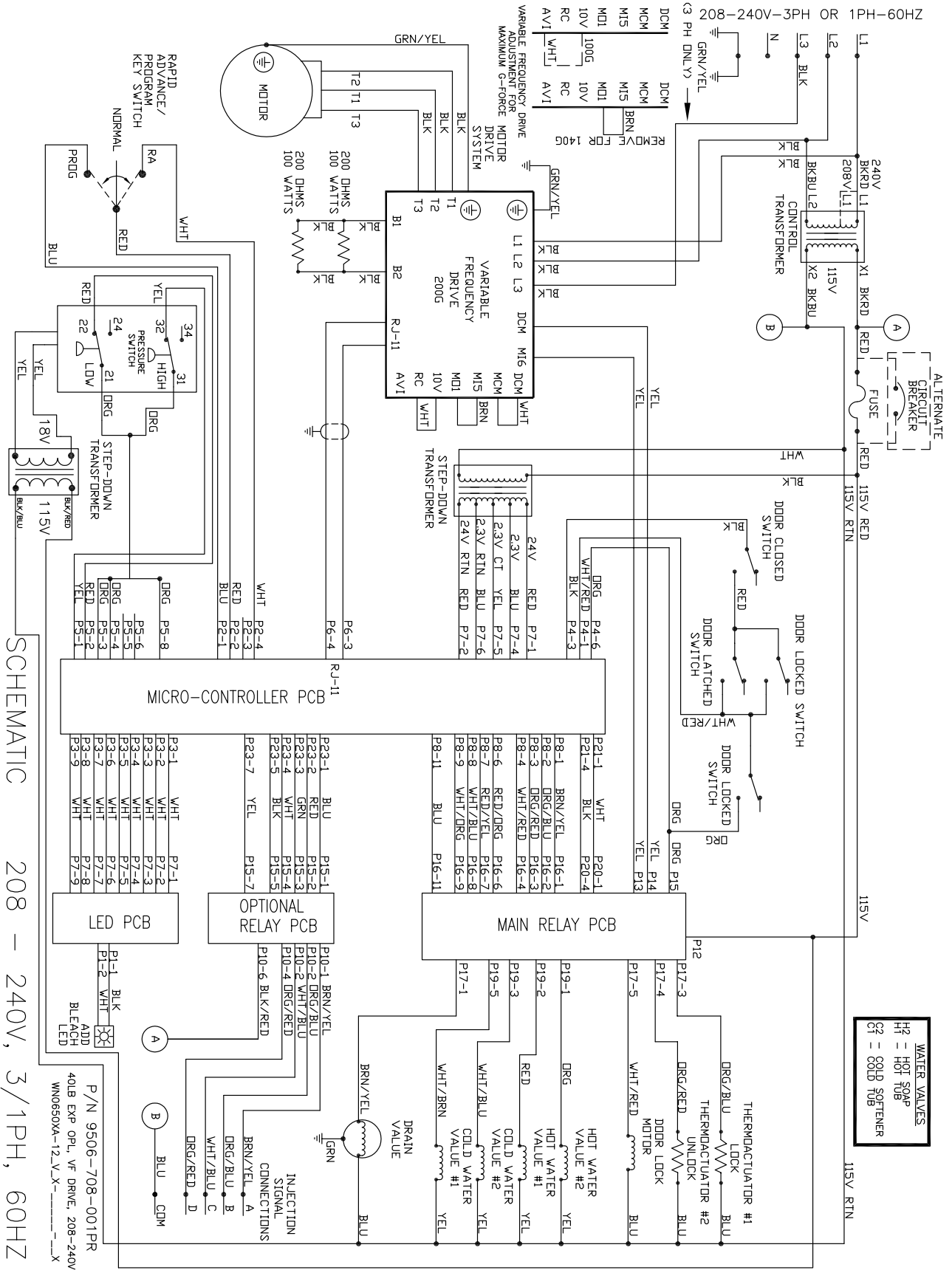

WN0650XA-12 Diagram

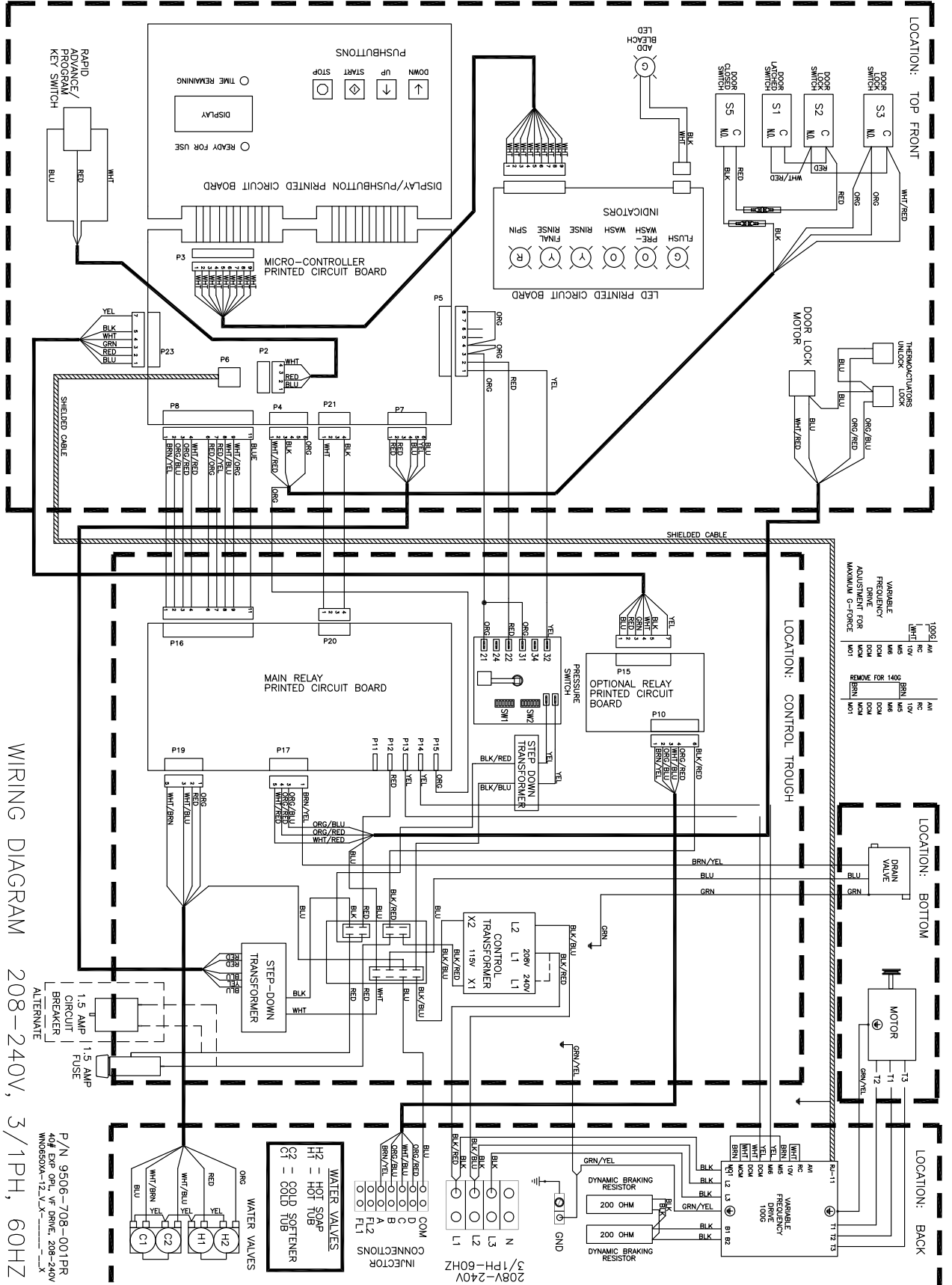

WIRING DIAGRAM

208-240V, 3/1PH, 60HZ

P/N 9506-708-001PR
 4# EXP ORN W/ 98N2, 208-240V
 WN0650XA-12, V.A. X

WN0750XA-12 Schematic

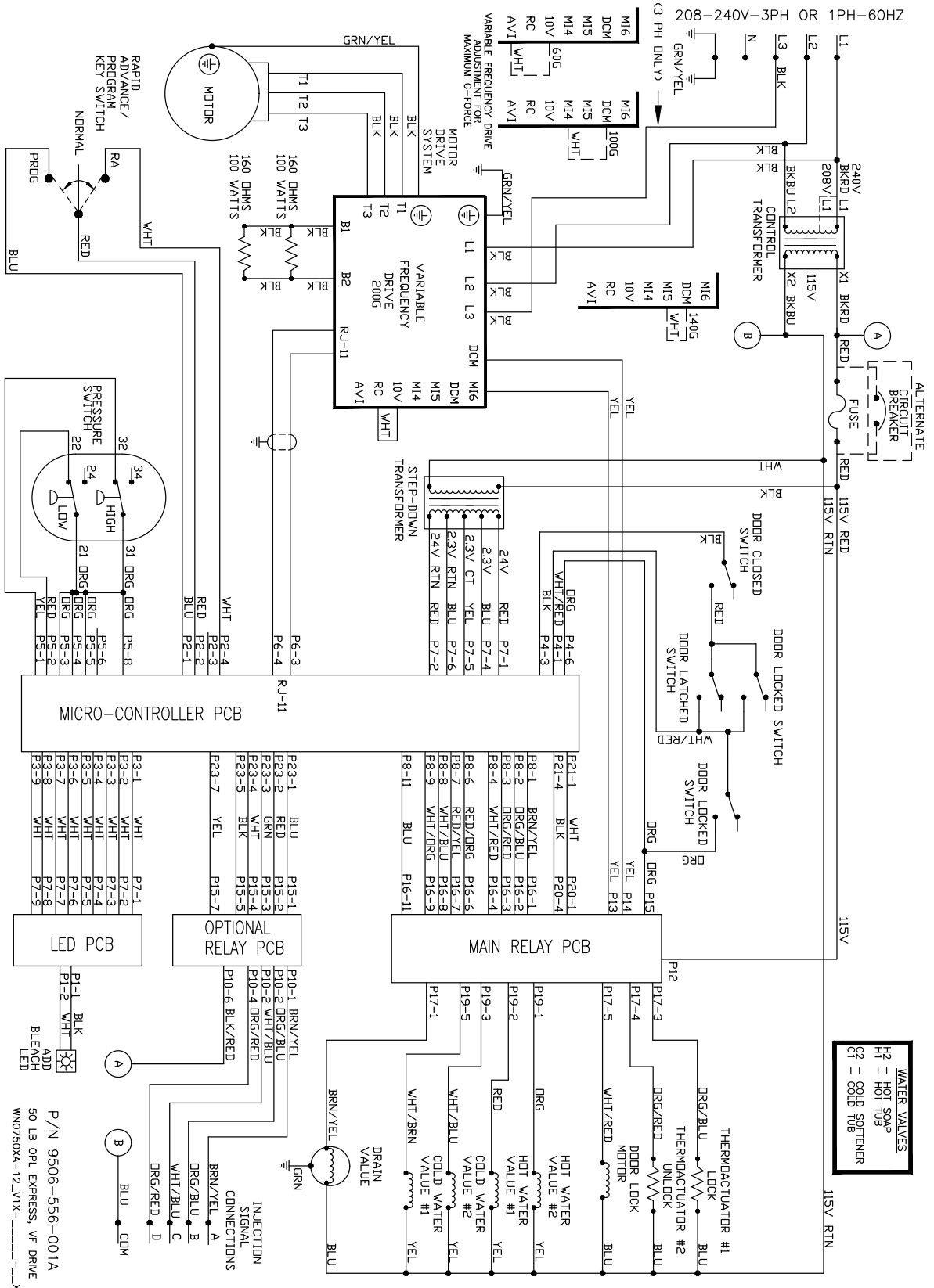

WN0750XA-12 Diagram

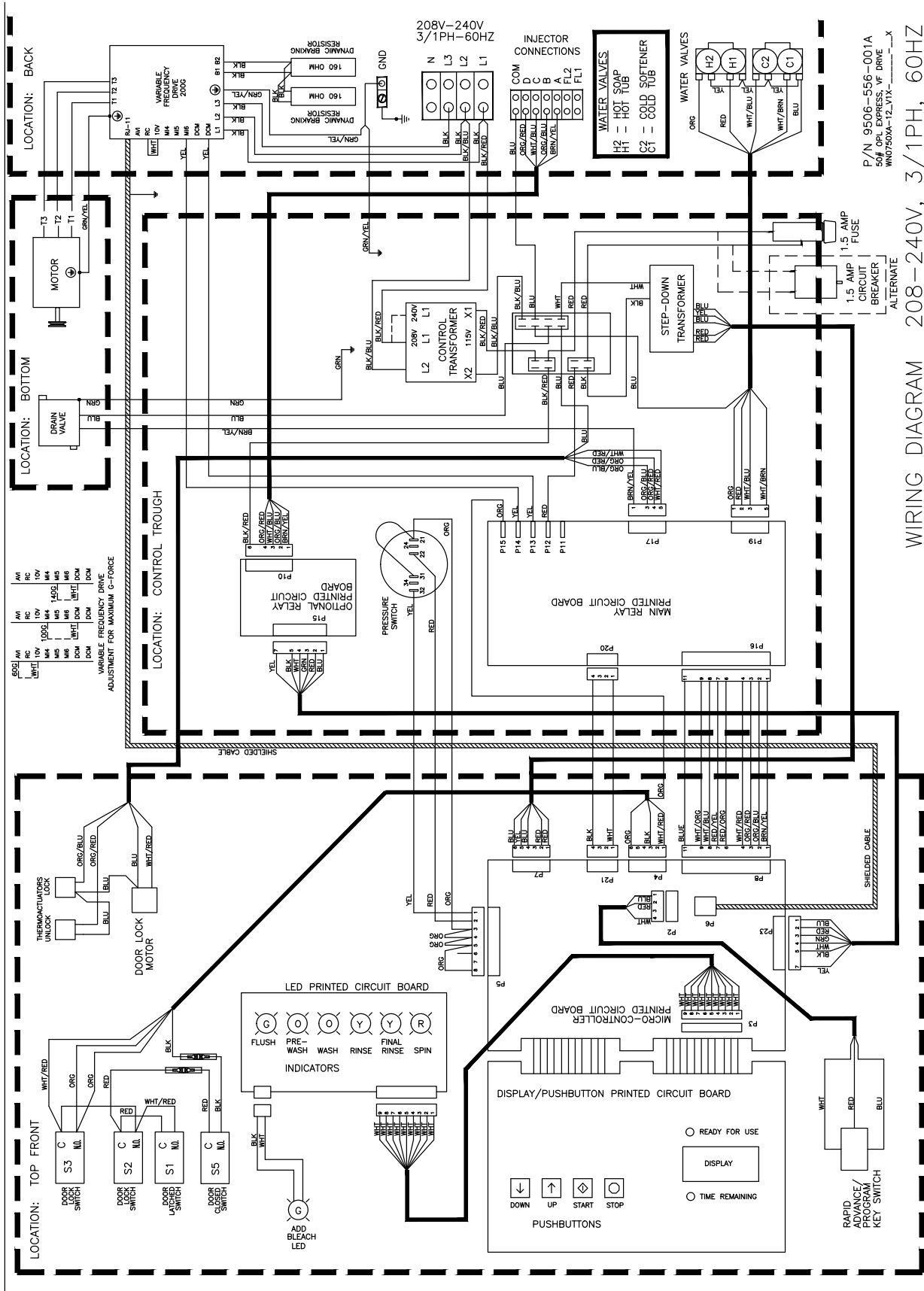

P/N 9506-556-001A
 WIRING PRESS. V. DRIVE
 WN0750A-12-1A-X

WIRING DIAGRAM 208-240V, 3/1PH, 60HZ

WN0950XA-12 Schematic

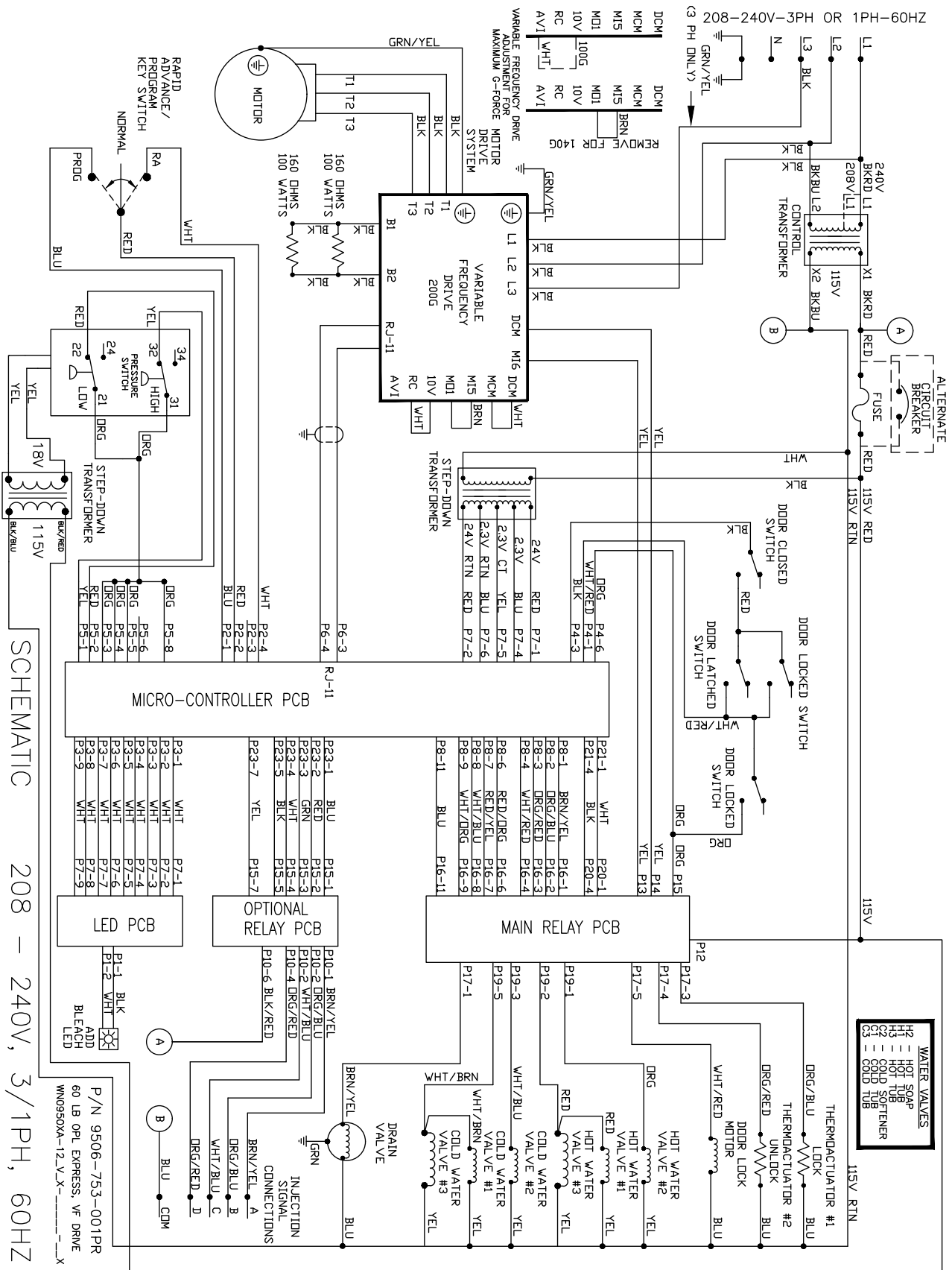

WN0950XA-12 Diagram

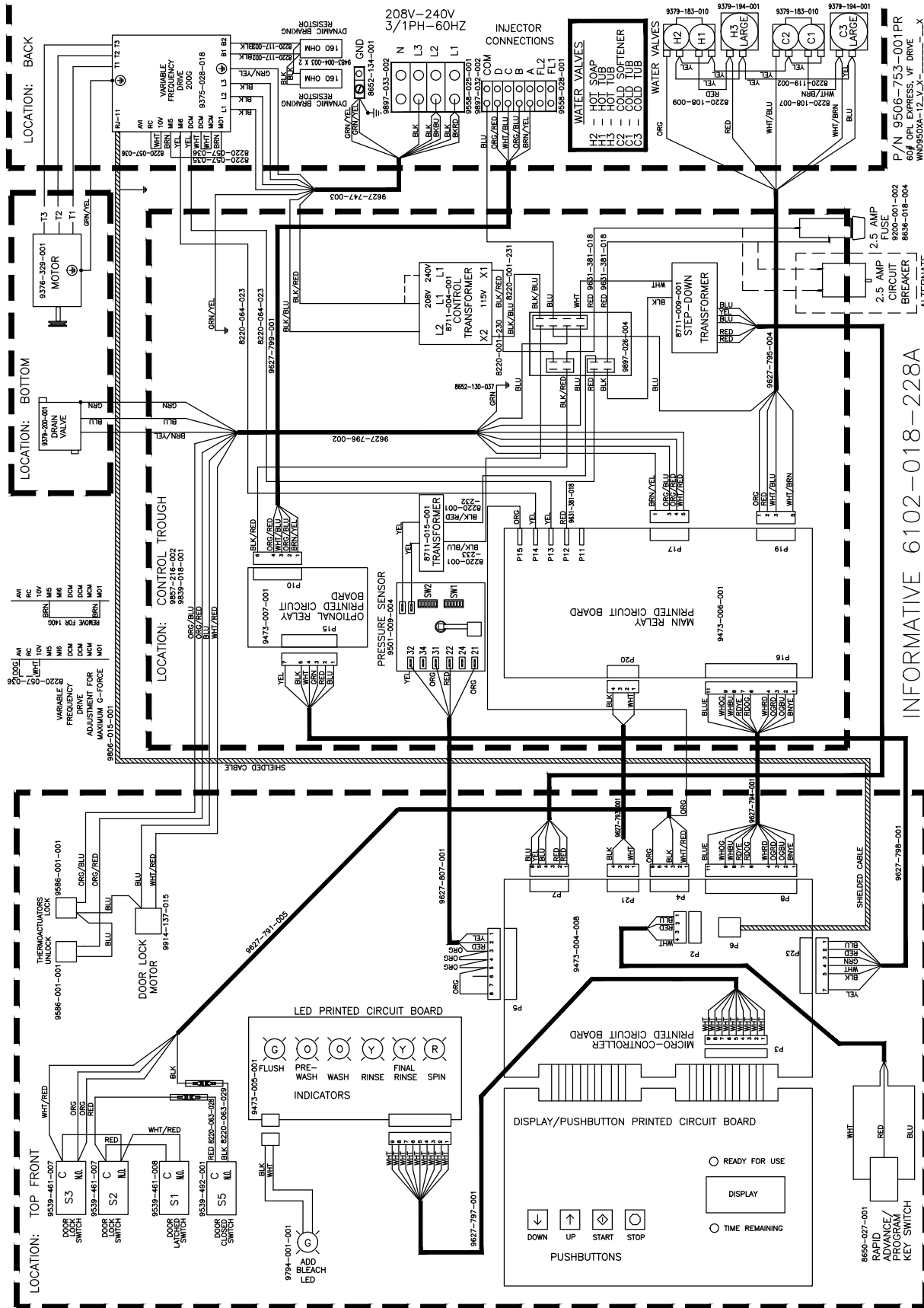

INFORMATIVE 6102-018-228A

WIRING DIAGRAM 208-240V, 3/1PH, 60HZ

P/N 9506-753-001PR
 80P CPL EXPRESS, V DRIVE
 WN0950XA-12, 7, 8, 9, 10, 11, 12, 13

WN1450XA-12 Schematic

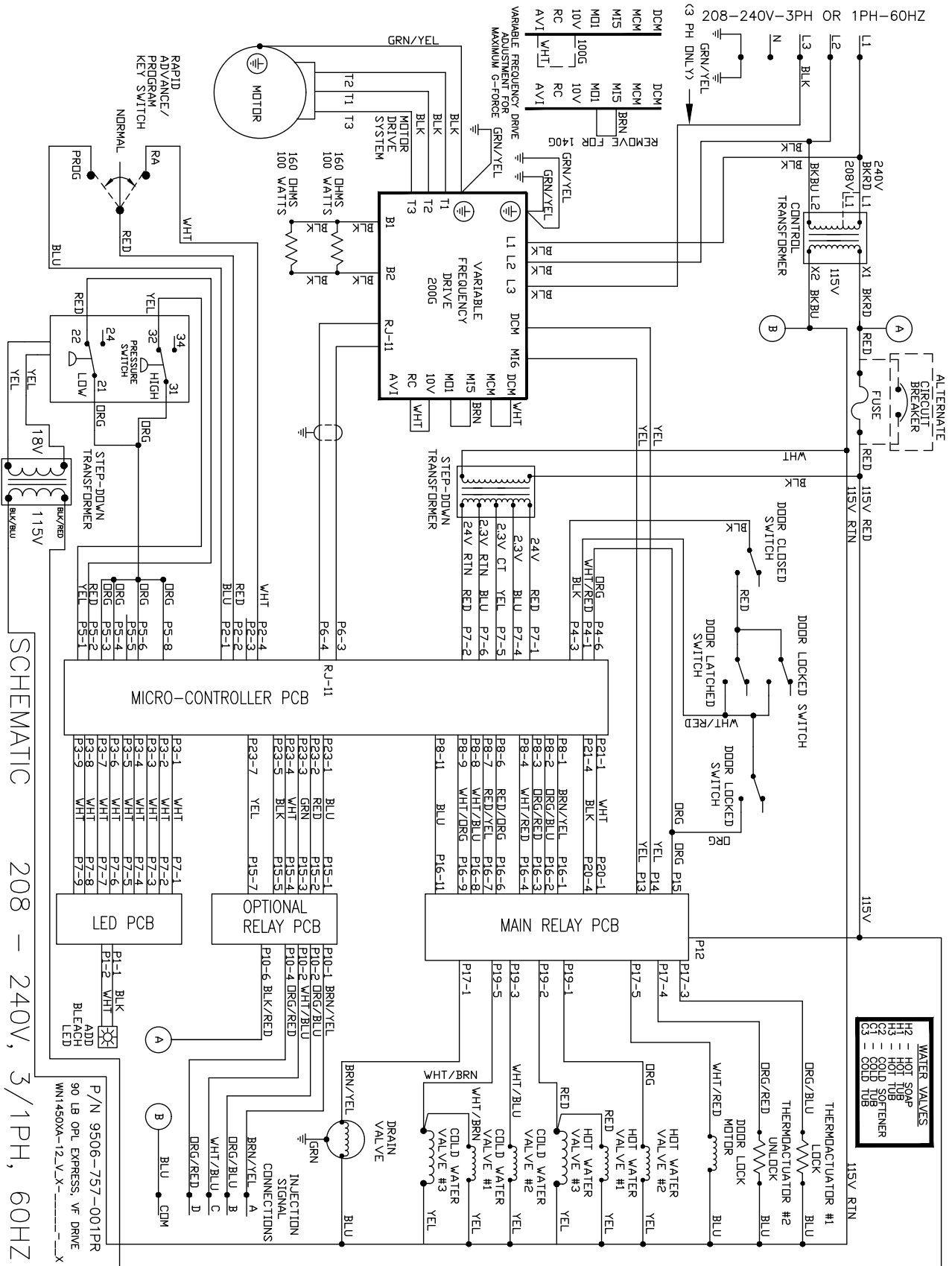



Section 8:

Parts Data

| | | | |
|---------------|---------------|-------|-----------------------------|
| WN0650XA-12EV | 208-240 volts | 60hz | Single Phase or Three Phase |
| WN0750XA-12EV | 208-240 volts | 60hz. | Single Phase or Three Phase |
| WN0950XA-12EV | 208-240 volts | 60hz | Single Phase or Three Phase |
| WN1450XA-12EV | 208-240 volts | 60 hz | Single Phase or Three Phase |

C-Series OPL Accessories

| | | | |
|---------------|---------------|-------|-----------------------------|
| WN0650XA-12EV | 208-240 volts | 60hz | Single Phase or Three Phase |
| WN0750XA-12EV | 208-240 volts | 60hz. | Single Phase or Three Phase |
| WN0950XA-12EV | 208-240 volts | 60hz | Single Phase or Three Phase |
| WN1450XA-12EV | 208-240 volts | 60 hz | Single Phase or Three Phase |

| Key | Description | T650 | T750 | T950 | T1450 | QTY |
|-----|---|----------------|----------------|----------------|----------------|-----|
| * | Hose, Water Supply 3/8" I.D. x 48" | 9990-027-011 | | | | 2 |
| * | Hose, Water Supply 5/8" I.D. x 48" | | 9990-027-013 | 9990-027-013 | | 2 |
| | Hose, Water Supply 5/8" I.D. x 48" | | | | 9990-027-013 | 4 |
| * | Washer, Inlet Hose (furnished) | 8641-242-000 | 8641-242-000 | 8641-242-000 | 8641-242-000 | 2 |
| * | Strainer, Inlet Hose (furnished) | 9565-003-001 | 9565-003-001 | 9565-003-001 | 9565-003-001 | 2 |
| * | Bevel Washer for 5/8" bolt used in installations using angle iron bases | | | | | |
| * | Bevel Washer for 3/4" bolt used in installations using angle iron bases | | 8641-586-003 | 8641-586-003 | 8641-586-003 | 4 |
| * | Sealing compound RTV-45 | 8538-151-002 | 8538-151-002 | 8538-151-002 | 8538-151-002 | 1 |
| * | Flow Restrictors (in dispenser) | 9475-002-002 | 9475-002-002 | 9475-002-003 | 9475-002-003 | 2 |
| * | Battery (used on Control PCB) | 8612-001-001 | 8612-001-001 | 8612-001-001 | 8612-001-001 | 1 |
| * | VFD Filter options (1 phase) 120v | | | | | 1 |
| * | VFD Filter options (3 phase) | | | | | 1 |
| * | VFD Filter options (1 phase) | | | | | 1 |
| * | Puller for pushing cylinder out of bearings must be purchased from local sources. | | | | | 1 |
| * | Clamps to hold tub front to outer tub when installing tub front | Vise Grip #11R | Vise Grip #11R | Vise Grip #11R | Vise Grip #11R | 1 |
| * | OPL Bearing & Seal Kit | 9732-219-007 | 9732-219-007 | 9732-219-007 | | 1 |
| * | OPL Op CD with OS2 Platform for V Series Washer Controls | 9504-016-001 | 9504-016-001 | 9504-016-001 | 9504-016-001 | 1 |
| | Palm Pilot Zire 31 | 9150-035-001 | 9150-035-001 | 9150-035-001 | 9150-035-001 | 1 |
| | Key Service Lock (6324) | 6292-006-007 | 6292-006-007 | 6292-006-007 | 6292-006-007 | 1 |
| | Key, Program (N561) | 6292-006-013 | 6292-006-013 | 6292-006-013 | 6292-006-013 | 1 |
| | USB Thumb Drive W/Opreator Booklets all sizes | 9150-045-002 | 9150-045-002 | 9150-045-002 | 9150-045-002 | |

Wiring Harness Part # by Model

| Key | Description | T650 | T750 | T950 | T1450 | QTY |
|-----|--|--------------|--------------|--------------|--------------|-----|
| * | Wiring Harness (Add Bleach Lite assy included) | 9794-001-001 | 9794-001-001 | 9794-001-001 | 9794-001-001 | 1 |
| * | Wiring Harness, Door Lock | 9627-791-005 | 9627-791-005 | 9627-791-005 | 9627-791-005 | 1 |
| * | | | | | | |
| * | Wiring Harness, Drain,Thermo,DoorSol | 9627-796-002 | 9627-796-002 | 9627-796-002 | 9627-796-002 | 1 |
| * | Data Cable | 9806-015-001 | 9806-015-001 | 9806-015-001 | 9806-015-003 | 1 |
| * | Wiring Harness P20/P21 | 9627-793-001 | 9627-793-001 | 9627-793-001 | 9627-793-001 | 1 |
| * | Wiring Harness P8/P16 | 9627-794-001 | 9627-794-001 | 9627-794-001 | 9627-794-001 | 1 |
| * | Wiring Harness WaterValve/P19 | 9627-795-004 | 9627-795-004 | 9627-795-004 | 9627-795-004 | 1 |
| * | Wiring Harness LED PCB | 9627-797-001 | 9627-797-001 | 9627-797-001 | 9627-797-001 | 1 |
| * | Wiring Harness P5/pressure | 9627-806-001 | 9627-807-001 | 9627-807-001 | 9627-900-001 | 1 |
| | Wiring Harness, P23/P15 | 9627-798-001 | 9627-798-001 | 9627-798-001 | 9627-798-001 | |
| | Wiring Harness, P10 | 9627-799-001 | 9627-799-001 | 9627-799-002 | 9627-799-002 | |
| * | Wiring Assembly Yel. 32" | | | 8220-064-023 | | 2 |
| * | Wiring Assembly Yel. 64" | | | | 8220-064-040 | 2 |
| * | Wiring Assembly Red 23" #8 | 8220-063-028 | 8220-063-028 | | | 1 |
| * | Wiring Assembly Red 41" | | | | 8220-062-032 | 2 |
| * | Wiring Assembly Vio. 24" | | | | 8220-118-001 | 2 |
| * | Wiring Assembly Wht/Brn 8" | | | | 8220-108-007 | 1 |
| * | Wiring Assembly Jumper Yel | 8220-123-001 | 8220-123-001 | 8220-128-001 | 8220-128-001 | 1 |
| * | Wire Red Yellow 8" | | | | 8220-108-008 | 1 |
| * | Wire Yellow Jumper (water valve) | | | | 8220-119-002 | 1 |
| * | 80lb Washer Dispenser Label | | | | 8502-687-001 | 1 |
| * | Wiring Assembly Red 28" #24 | 8220-062-025 | 8220-062-025 | 8220-062-025 | | 2 |
| * | Wiring Assembly Blk. 17" | | | 8220-062-028 | 8220-062-028 | 1 |
| * | Wiring Assembly Red 17" | | | 8220-062-027 | 8220-062-027 | 1 |
| * | Wiring Assembly Jumper BLK. | 8220-117-002 | 8220-117-002 | 8220-117-002 | 8220-117-003 | 2 |
| * | Wiring Assembly Red 7" #36 | 9631-381-018 | 9631-381-018 | 9631-381-018 | 9631-381-018 | 1 |
| * | Wiring Assembly Blu/Wht | 8220-090-009 | 8220-090-009 | 8220-090-009 | 8220-090-009 | 1 |
| * | Wiring Assembly Blk/Blu | 8220-001-231 | 8220-001-231 | 8220-001-231 | 8220-001-231 | 1 |
| * | Wire Assembly Green 7" | | | | | 1 |
| * | Wire Assembly BLK. 23" #8 | 8220-063-029 | 8220-063-029 | | | |
| * | Harness Power Terminal Block | 9627-747-003 | 9627-747-003 | 9627-747-002 | 9627-747-002 | 1 |

Cabinet and Front Panel Group Part # by Model

Large Door

| Key | Description | T650 | T750 | T950 | T1450 | QTY |
|-----|--|--------------|--------------|---------------|--------------|-----|
| 1 | Panel, Side (Left or Right) - stainless | | 9454-812-001 | | | 2 |
| 1 | Panel, Side (Left or Right) - stainless | 9454-914-001 | | 9454-839-001 | 9454-836-001 | 4 |
| * | Bolt-1/4-20x1/2 (side panel Front to Rear) | | | 9545-018-013 | 9545-018-013 | 8 |
| | Nut 1/4-20UNC (side panel) | | | 8640-414-006 | 8640-414-006 | 8 |
| | Strap Assy (Side to base) | 9966-012-001 | 9966-013-001 | | | 2 |
| | Strap Assy (Side to base) | | | 9966-012-001 | 9966-012-001 | 4 |
| * | Shim (side panel) | 9552-038-001 | 9552-041-001 | 9552-039-001 | 9552-044-001 | 2 |
| * | Nut, Hex 1/4-20 UNC (for strap assembly) | 8640-414-006 | 8640-414-006 | | | 6 |
| * | Nut, Hex 1/4-20 UNC | | | 8640-414-006 | 8640-414-006 | 8 |
| 2 | Bracket, Side Panel under front panel | 9046-094-001 | 9046-085-001 | 9046-085-001 | 9046-086-001 | 1 |
| * | Screw #10Bx1/2 side panel brkt | 9545-008-026 | 9545-008-026 | 9545-008-026 | 9545-008-026 | 1 |
| * | Nut 1/4-20 UNC side panel brkt | 8640-414-003 | 8640-414-006 | 8640-414-006 | 8640-414-006 | 1 |
| • | Nut, Hex | | | 8640-413-002 | 8640-414-006 | 2 |
| * | Screw | | | 9545-008-024 | 9545-008-026 | 2 |
| 3 | Panel Assy, Front | 9454-913-002 | 9454-810-002 | 9454-840-0012 | 9454-852-002 | 1 |
| * | | | | | | 1 |
| 4 | Band, Edge Protector | 9578-092-005 | 9578-092-002 | 9578-092-002 | 9578-092-002 | 1 |
| * | Bumper Loading Door | 9051-055-001 | 9051-055-001 | 9051-055-001 | 9051-055-001 | 1 |
| * | Nut, 1/4 x 20 for bumper | 8640-414-006 | 8640-414-006 | 8640-414-006 | 8640-414-006 | 1 |
| * | Screw, Hex- To Control Panel | 9545-008-014 | 9545-008-014 | 9545-008-024 | 9545-008-024 | 2 |
| * | Nut, Spring- To Control Panel 10/32 | 8640-399-003 | 8640-399-003 | 8640-399-003 | 8640-399-003 | 2 |
| 5 | Screw, Flat Head- Front to Sides | 9545-008-014 | 9545-008-014 | 9545-008-014 | 9545-008-014 | 2 |
| 5 | Screw, Flat Head- Front to Sides | | | | | 4 |
| 6 | Washer, Finish | 8641-585-001 | 8641-585-001 | 8641-585-001 | 8641-585-001 | 2 |
| 6 | Washer, Finish | | | | | 4 |
| * | Nut, Spring-To Front Panel | 8640-399-008 | 8640-399-008 | 8640-399-008 | 8640-399-008 | 2 |
| 7 | Label, Door Opening (Black) | 8502-757-001 | 8502-757-001 | 8502-757-001 | 8502-757-001 | 1 |
| 8 | Panel, Control (Mounts Nameplate) | 9989-479-001 | 9989-480-001 | 9989-480-001 | 9989-530-001 | 1 |
| * | Screw, Control Panel to Sides | 9545-008-026 | 9545-008-026 | 9545-008-026 | 9545-008-026 | 4 |
| 9 | Nameplate Decal, Control Black | 9412-236-001 | 9412-223-001 | 9412-225-001 | 9412-230-001 | |
| 10 | Panel Top | 9454-912-001 | 9454-743-001 | 9454-736-001 | | 1 |
| 11A | Panel Top Front | | | | 9454-850-001 | 1 |
| 11B | Panel Top Rear | | | | 9454-851-001 | 1 |
| 12 | Lock, Top (w/Key) | 8650-012-003 | | | | 1 |
| 12 | Lock, Top (w/Key) | | 8650-012-003 | 8650-012-003 | 8650-012-003 | 2 |
| 13 | Door, Lower Service, Includes Handle | 9960-286-002 | 9960-286-004 | 9960-286-004 | 9960-286-005 | 1 |
| 14 | Handle (bumper guard) | 9244-086-002 | 9244-086-003 | 9244-086-003 | 9244-086-004 | 1 |
| * | Rivet Blind 3/16" Alum | 9491-009-003 | 9491-009-003 | 9491-009-003 | 9491-009-003 | 4 |
| * | Screw | 9545-045-010 | 9545-045-010 | 9545-045-010 | 9545-045-010 | 4 |

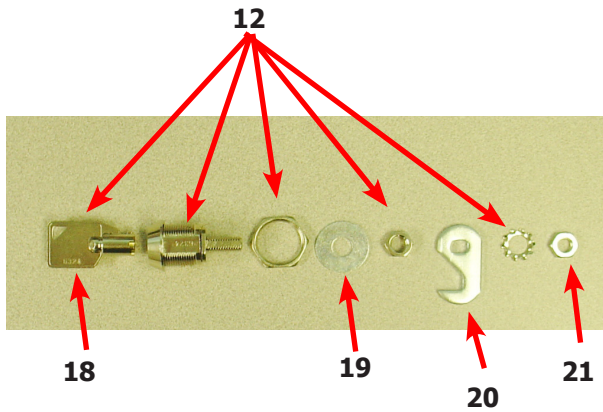
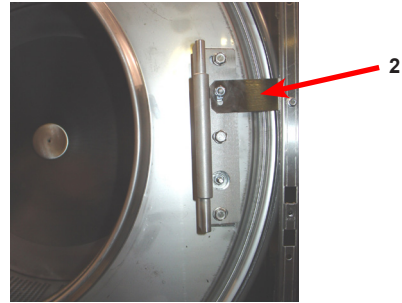

| Key | Description | T650 | T750 | T950 | T1450 | QTY |
|-----|---------------------------------|--------------|--------------|--------------|--------------|-----|
| 15 | Screw Mtg., Flat Head 10Bx1 3/4 | 9545-008-014 | 9545-008-014 | 9545-008-014 | 9545-008-014 | 2 |
| 16 | Washer, Finish | 8641-585-001 | 8641-585-001 | 8641-585-001 | 8641-585-001 | 2 |
| * | Nut, Spring | 8640-399-008 | 8640-399-008 | 8640-399-008 | 8640-399-008 | 2 |
| 17 | Label-Risk of injury (Black) | 8507-759-001 | 8507-759-001 | 8507-759-001 | 8507-759-001 | 1 |
| 18 | Key, Top- # 6324 | 6292-006-007 | 6292-006-007 | 6292-006-007 | 6292-006-007 | |
| 19 | Washer Flat 5/16 | 8641-581-008 | 8641-581-008 | 8641-581-008 | 8641-581-008 | 2 |
| 20 | Cam, Lock-Top | 9095-049-001 | 9095-049-001 | 9095-049-001 | 9095-049-001 | 2 |
| 21 | Nut, 9/32 - 28 Hex | 8640-426-001 | 8640-426-001 | 8640-426-001 | 8640-426-001 | 2 |

Cabinet and Front Panel Group Part # by Model

Front Soap Dish

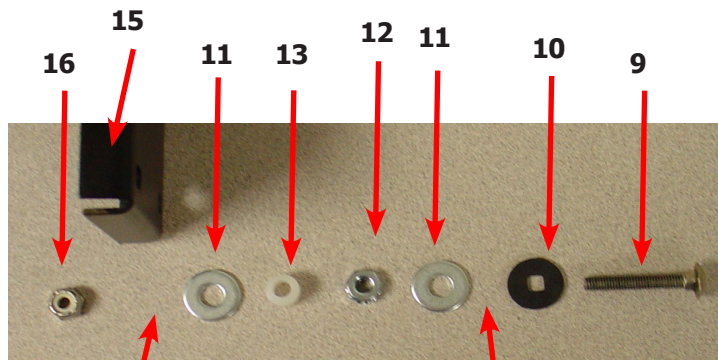
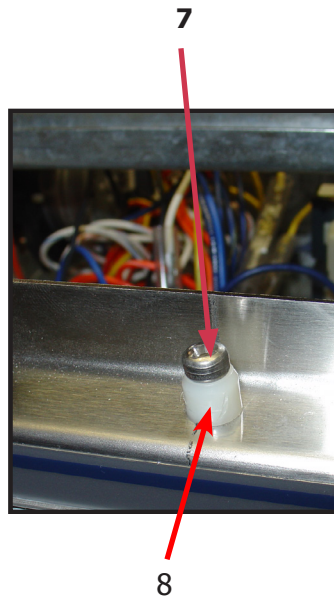
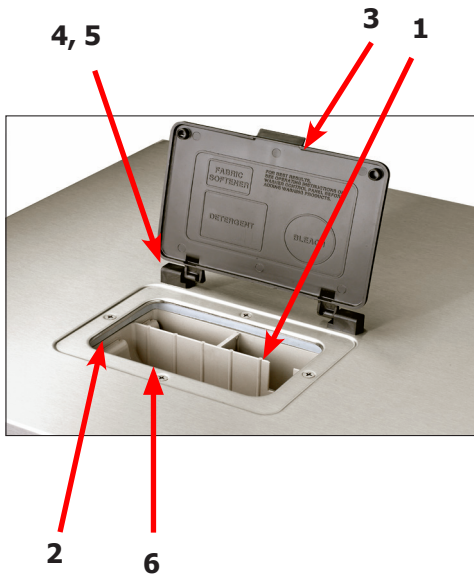

Gasket and Soap Dish Here

Tub Front Here

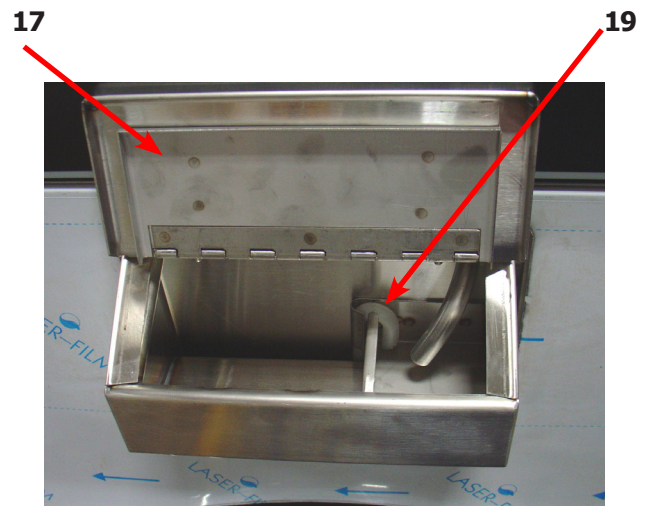
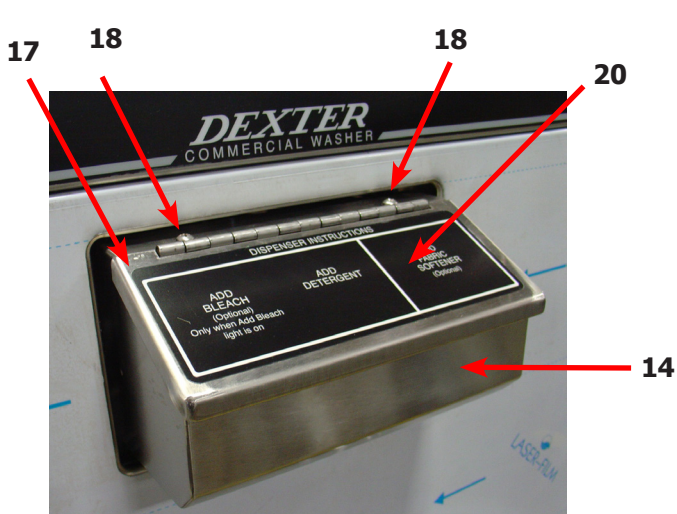

Top Mount Detergent Dispenser

| Key | Description | T650 | T750 | T950 | T1450 | QTY |
|-----|-------------------------------------|--------------|--------------|--------------|--------------|-----|
| 1 | Dispenser Soap | 9122-005-004 | 9122-005-004 | 9122-005-004 | | 1 |
| 2 | Gasket Despinsor | 9206-416-001 | 9206-416-001 | 9206-416-001 | | 1 |
| * | Hose, Despinsor to tub | 9242-450-003 | 9242-450-001 | 9242-450-001 | | 1 |
| * | Clamp | 8654-117-008 | 8654-117-008 | 8654-117-008 | | 2 |
| * | Nut, Spring ss | 8640-399-007 | 8640-399-007 | 8640-399-007 | | 4 |
| * | Flow restrictors | 9475-002-002 | 9475-002-002 | 9475-002-002 | | 2 |
| * | Flow restrictors Optional (Smaller) | 9475-002-003 | 9475-002-003 | 9475-002-003 | | 2 |
| 3 | Door, Dispenser | 9108-095-005 | 9108-095-005 | 9108-095-005 | | 1 |
| 4 | Pin, Plain | 9451-191-001 | 9451-191-001 | 9451-191-001 | | 2 |
| * | Post, Door Mounting | 9467-025-001 | 9467-025-001 | 9467-025-001 | | 2 |
| 6 | Screw- 8B x 1/2 | 9545-045-002 | 9545-045-002 | 9545-045-002 | | 4 |
| | Screw, SS Dispenser, 10B x 1 | 9545-008-012 | 9545-008-012 | 9545-008-012 | | 4 |
| * | Washer Flat 5/16 | 8641-581-008 | 8641-581-008 | 8641-581-008 | 8641-581-008 | 1 |
| 7 | Screw, Locator | 9545-008-023 | 9545-008-023 | 9545-008-023 | 9545-008-023 | 1 |
| 8 | Plastic Sleeve, Locator | 9355-001-001 | 9355-001-001 | 9355-001-001 | 9355-001-001 | 1 |
| * | Catch, Top Panel | 9086-017-001 | 9086-017-001 | 9086-017-001 | 9086-017-001 | 2 |
| | Lock, Top (w/Key) | 8650-012-003 | | | | 1 |
| * | Lock, Top (w/Key) | | 8650-012-003 | 8650-012-003 | 8650-012-003 | 2 |

Front Mount Detergent Dispenser

| Key | Description | T650 | T750 | T950 | T1450 | QTY |
|-----|---|------|------|------|--------------|-----|
| 9 | Bolt,#10-32 x 1 1/4"SS | | | | 9545-012-026 | 6 |
| 10 | Special Washer, Rubber | | | | 8641-222-000 | 6 |
| * | Tub Front | | | | | 1 |
| 11 | Washer-Flat, 1/4 | | | | 8641-581-018 | 12 |
| 12 | Nut, #10-32UNF | | | | 8640-413-002 | 6 |
| 13 | Spacer Plastic #10x1/2 | | | | 9538-157-019 | 6 |
| 14 | Soap Dispenser (no lid) | | | | 9807-087-001 | 1 |
| * | Det. Dispenser Mtg Gasket to Tub frnt | | | | 9206-425-001 | 1 |
| 15 | Bracket Soap box mounting | | | | 9029-122-002 | 1 |
| 16 | Nut Hex Elasticstop #10-32 SS mtg dispenser | | | | 8640-413-006 | 6 |
| 17 | Lid Assembly dispenser | | | | 9987-104-001 | 1 |
| 18 | Lid screws #10-32x1/2 SS | | | | 9545-012-017 | 2 |
| 19 | Softner siphon tube (plastic) | | | | 9574-252-002 | 1 |
| * | Flow restrictors | | | | 9475-002-003 | AR |
| 20 | Washer Dispenser Label Black | | | | 8502-756-001 | 1 |
| * | Kit-Soap Dish, Replacement (Large Door) | | | | 9732-290-001 | |

Rear View Access Part # by Model

| Key | Description | T650 | T750 | T950 | T1450 | QTY |
|-----|--------------------------------------|--------------|--------------|--------------|--------------|-----|
| 1 | Drive Motor, 3 Phase (Inverter duty) | 9376-319-001 | 9376-329-001 | 9376-329-001 | 9376-328-001 | 1 |
| 2 | Rod, Motor Mtg | 9497-222-004 | 9497-222-004 | 9497-222-004 | 9497-222-004 | 1 |
| * | Collar, Shaft (w/set screws) (old) | 9076-052-002 | 9076-052-002 | | 9076-052-002 | 2 |
| * | Motor Bushing (plastic) | 9053-074-002 | 9053-074-002 | 9053-074-002 | 9053-074-002 | 1 |
| 3 | New motor bushing support | 9053-082-001 | 9053-082-001 | 9053-082-001 | 9053-082-001 | 2 |
| 4 | Clamp for motor bushing | 8654-117-019 | 8654-117-019 | 8654-117-019 | 8654-117-019 | 2 |
| 5 | Pulley, Motor | 9453-170-003 | 9453-179-001 | 9453-175-002 | 9453-175-002 | 1 |
| * | Set Screw 5/16 18-7/8 | 9545-028-015 | | | | |
| * | Split TaperBushing (motor pulley) | | 9053-077-001 | 9053-077-001 | 9053-077-001 | 2 |
| * | Screw taper bushing 1/4-20x1 | | 9545-018-024 | 9545-018-024 | 9545-018-024 | 3 |
| 6 | Bolt, Eye (1/4"-20x1/2") | 9545-055-001 | 9545-055-001 | 9545-055-001 | 9545-055-001 | 1 |
| * | Nut, 1/4 Elastic Stop | 8640-414-003 | 8640-414-003 | 8640-414-003 | 8640-414-003 | 1 |
| * | Link (open end) | | 9341-046-001 | 9341-046-001 | | 1 |
| 7 | Chain (Spring Tension) | | 9099-012-003 | 9099-012-003 | | 1 |
| 8 | Spring, Belt Tension | 9534-151-000 | 9534-151-000 | 9534-151-000 | 9534-151-000 | 1 |
| * | Bracket Belt Tension | | | | 9029-206-002 | 1 |
| * | Lock Washer, Exttooth, 5/16 | | | | 8641-582-009 | |
| 9 | Pulley, Driven | 9453-173-002 | 9453-173-002 | 9453-176-005 | 9453-176-005 | 1 |
| * | Tolerance Ring | 9487-234-004 | 9487-234-004 | | | 1 |
| * | Screw, 5/8"-11 x 2" | 9545-060-004 | 9545-060-004 | | | 1 |
| * | Washer-Flat, 5/8" | 8641-582-032 | 8641-582-032 | | | 1 |
| * | Washer-Flat, 5/8" | 8641-581-018 | 8641-581-018 | | | 1 |
| 10 | Bolt, 3/8"-16 x 2" | | | 9545-029-011 | 9545-029-011 | 3 |
| 11 | Washer, 3/8" | | | 8641-582-003 | 8641-582-003 | 3 |
| * | Bushing Taperlock (Driven) | | | 9053-078-002 | 9053-078-002 | 1 |
| 12 | Washer-Flat .675x2-1/2x1/4 | 8641-581-043 | 8641-581-043 | 8641-581-043 | | 1 |
| 13 | Lockwasher-Exttooth, 5/8 | 8641-582-018 | 8641-582-018 | 8641-582-018 | | 1 |
| 14 | Bolt, 5/8-11x1 1/2 | 9545-060-001 | 9545-060-001 | 9545-060-001 | | 1 |
| 12 | Washer-Flat, .781x2-1/2x1/4 | | | | 8641-581-044 | 1 |
| 13 | Lockwasher-Exttooth, 3/4 | | | | 8641-582-020 | 1 |
| 14 | Bolt, 3/4-10-1 1/2 | | | | 9545-057-004 | 1 |
| 15 | Drive Belt | | | 9040-079-002 | 9040-079-006 | 1 |
| 15 | Drive Belt | 9040-076-005 | 9040-076-008 | | | 2 |
| * | Panel Assy., Back | 9989-567-001 | 9989-455-001 | 9989-526-001 | | 1 |
| * | Panel Assy., Back, Upper | | | | 9454-872-001 | 1 |
| * | Panel Assy., Back, Lower | | | | 9454-873-001 | 1 |
| * | Screw Panel Mtg.#10Bx1/2" | 9545-008-026 | 9545-008-026 | | | |
| * | Screw Panel Mtg.#10Bx1/2" | | | 9545-008-026 | | |
| * | Screw Panel Mtg.#10Bx1/2" | | | | 9545-008-026 | 15 |
| * | Nut, Spring | 8640-399-008 | 8640-399-008 | 8640-399-008 | 8640-399-008 | AR |
| * | Screw, To Base-1/4" x 3/4" | 9545-030-002 | 9545-030-002 | 9545-030-002 | 9545-030-002 | 3 |
| | | | | | | |
| | | | | | | |

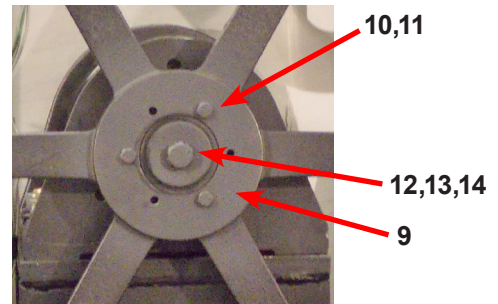
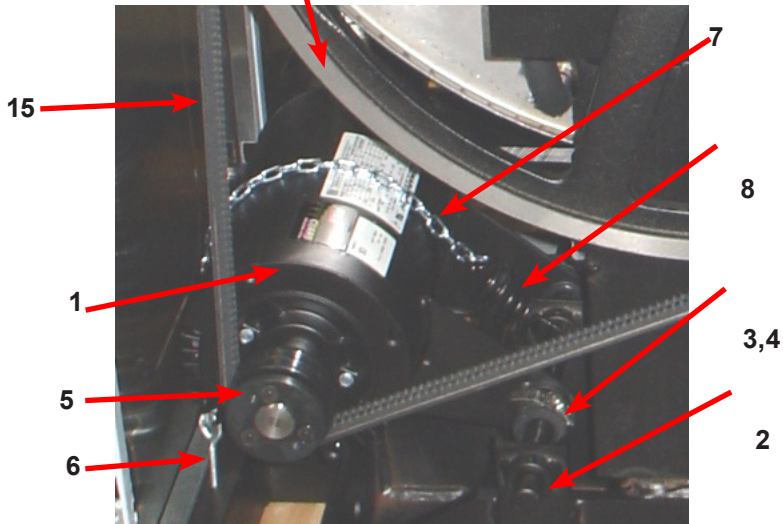
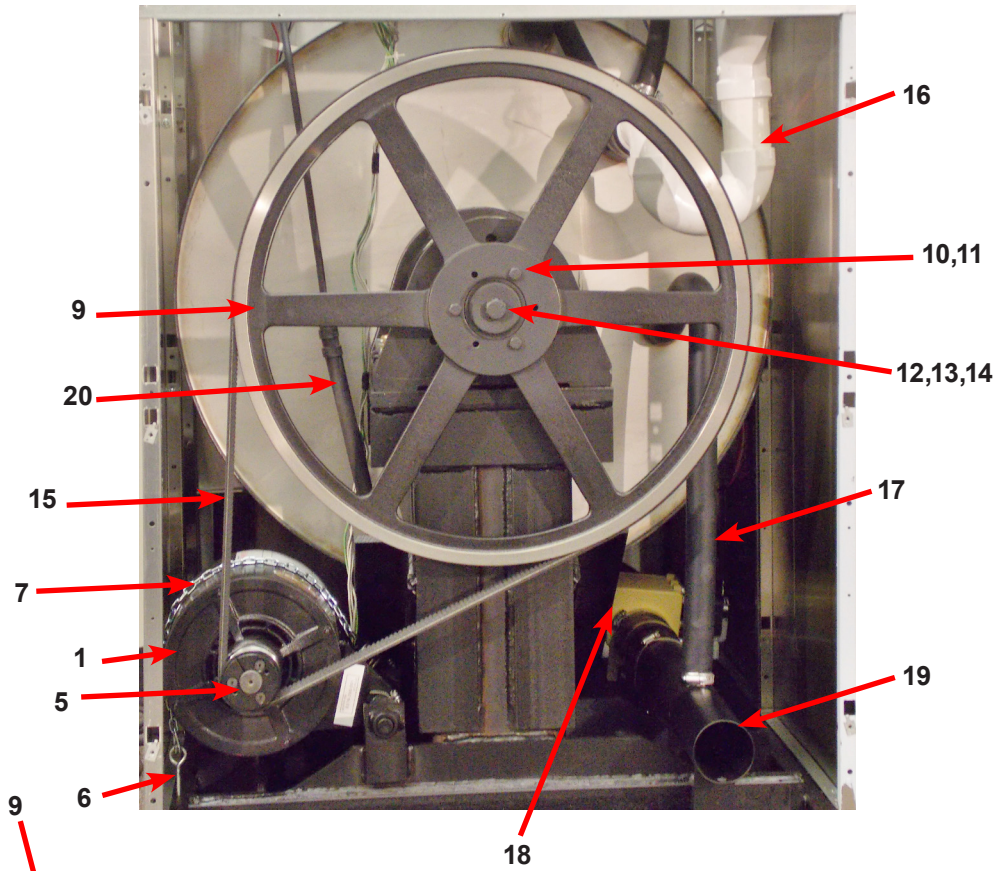

| Key | Description | T650 | T750 | T950 | T1450 | QTY |
|-----|-----------------------------|--------------|--------------|--------------|--------------|-----|
| 16 | Injection- tube assy | 9883-005-001 | 9883-005-001 | 9883-012-001 | 9883-011-001 | 1 |
| * | Hose, Injection Tube to Tub | 9242-461-001 | 9242-461-001 | 9242-461-001 | 9242-461-001 | 1 |
| * | Clamp, Injection Hose | 8654-117-014 | 8654-117-014 | 8654-117-014 | 8654-117-014 | 2 |
| 17 | Hose-Overflow | 9242-449-002 | 9242-449-003 | 9242-449-003 | 9242-449-005 | 1 |
| * | Clamp Hose Over Flow | 8654-117-008 | 8654-117-008 | 8654-117-008 | 8654-117-008 | 2 |
| 18 | Drain Valve | 9379-202-001 | 9379-202-001 | 9379-202-001 | 9379-202-001 | 1 |
| * | Hose, Drain Valve to Tube | 9242-457-001 | 9242-457-001 | 9242-457-001 | 9242-457-001 | 1 |
| * | Clamp | 8654-117-014 | 8654-117-014 | 8654-117-014 | 8654-117-014 | 2 |
| 19 | Drain Tube | 9915-124-002 | 9915-124-002 | 9915-120-004 | 9915-129-002 | 1 |
| 20 | Hose-Pressure Switch | 9242-175-002 | 9242-175-007 | 9242-175-007 | 9242-175-004 | 1 |
| * | Clamp Pressure switch Tube | | 8654-117-015 | | | |

Rear Channel Parts Group

| Key | Description | T650 | T750 | T950 | T1450 | QTY |
|-----|--|--------------|--------------|--------------|--------------|-----|
| * | Channel Assembly Rear | 9947-032-001 | 9947-027-001 | | | |
| 1 | Channel, Rear | 9081-176-001 | 9081-168-001 | 9081-169-002 | 9081-170-001 | 1 |
| 2 | Screw #10Bx1/2 | 9545-008-026 | 9545-008-026 | 9545-008-026 | 9545-008-026 | 4 |
| * | Nut, Spring | 8640-399-008 | 8640-399-008 | 8640-399-008 | 8640-399-008 | 4 |
| 3 | Plug, 7/8" | 9456-041-006 | 9456-041-006 | 9456-041-006 | 9456-041-006 | 1 |
| 4 | Bushing, 7/8" | 9053-067-002 | 9053-067-002 | 9053-067-002 | 9053-067-002 | 1 |
| 5 | Braacket-Terminal Block Assy | 9029-265-001 | 9029-265-001 | 9029-265-001 | 9029-265-001 | 1 |
| 6 | Screw, 10Bx1/2 | 9545-008-026 | 9545-008-026 | 9545-008-026 | 9545-008-026 | 4 |
| 7 | Strip-Terminal marker, Power | 9558-025-001 | 9558-025-001 | 9558-025-001 | 9558-025-001 | 1 |
| 8 | Terminal Block-Power | 9897-033-002 | 9897-033-002 | 9897-033-002 | 9897-033-002 | 1 |
| * | Screw-6ABx3/4 | 9545-031-010 | 9545-031-010 | 9545-031-010 | 9545-031-010 | 2 |
| 9 | Harness-Power Terminal Block | 9627-747-003 | 9627-747-003 | 9627-747-003 | 9627-747-003 | 1 |
| 10 | Terrminal Lug, Solderless | 8652-134-001 | 8652-134-001 | 8652-134-001 | 8652-134-001 | 1 |
| * | Lockwasher-Exttooth, #10 | 8641-582-006 | 8641-582-006 | 8641-582-006 | 8641-582-006 | 1 |
| * | Screw-10-32ttX1x1/2Grn | 9545-008-027 | 9545-008-027 | 9545-008-027 | 9545-008-027 | 2 |
| 11 | Strip-Terminal Marking, Injector | 9558-028-001 | 9558-028-001 | 9558-028-001 | 9558-028-001 | 1 |
| 12 | Terminal Block-Injector | 9897-032-002 | 9897-032-002 | 9897-032-002 | 9897-032-002 | 1 |
| * | Screw-4Bx5/8ss | 9545-053-002 | 9545-053-002 | 9545-053-002 | 9545-053-002 | 2 |
| 13 | Harness-Injection | 9627-799-001 | 9627-799-001 | 9627-799-001 | 9627-799-002 | 1 |
| 14 | Label-Warning | 8502-639-001 | 8502-639-001 | 8502-639-001 | 8502-639-001 | 1 |
| 15 | Bushing-Insulated, 3/4" | 9053-067-001 | 9053-067-001 | 9053-067-001 | 9053-067-001 | 1 |
| 16 | Bushing-Insulated, 1" | 9053-067-004 | 9053-067-004 | 9053-067-004 | 9053-067-004 | 1 |
| * | Cover, Terminal Block | 9074-267-001 | 9074-267-001 | 9074-267-001 | 9074-267-001 | 1 |
| * | Screw #10Bx1/2 | 9545-008-026 | 9545-008-026 | 9545-008-026 | 9545-008-026 | 1 |
| 17 | Plate-Drive mounting | 9982-383-001 | 9982-383-001 | 9982-383-001 | 9982-384-001 | 1 |
| 18 | Nut, #10-32UNF, 2B | 8460-413-002 | 8460-413-002 | 8460-413-002 | 8460-413-002 | 4 |
| 19 | VFD Delta "E" drive 208-240 volt | 9375-030-014 | 9375-028-011 | 9375-028-018 | 9375-029-008 | 1 |
| * | Key Pad-Display Delta "E" Drive (P/S) only | 9150-044-001 | 9150-044-001 | 9150-044-001 | 9150-044-001 | |
| 20 | Nut, #10-32UNF, 2B | 8460-413-002 | 8460-413-002 | 8460-413-002 | 8460-413-002 | 4 |
| * | Cable, Data | 9806-015-001 | 9806-015-001 | 9806-015-001 | 9806-015-003 | 1 |
| * | Clamp, Cable | 8654-125-005 | 8654-125-005 | 8654-125-005 | 8654-125-005 | 1 |
| 21 | Plate-Water Valves, Mounting | 9452-813-001 | 9452-813-001 | 9452-814-001 | 9452-814-001 | 1 |
| 22 | Nut, #10-32UNF, 2B | 8460-413-002 | 8460-413-002 | 8460-413-002 | 8460-413-002 | 4 |
| 23 | Valve-Water, Duel Coil | 9379-183-012 | 9379-183-012 | 9379-183-012 | 9379-183-012 | 2 |
| 24 | Screw #10Bx1/2 | 9545-008-026 | 9545-008-026 | 9545-008-026 | 9545-008-026 | 4 |
| * | Plate-Cover, Water Valves | | | | | 1 |
| * | Screw, 10Bx1/2 | | | | | 2 |
| 25 | Water-Valve, Single Coil | | | 9379-194-001 | 9379-194-001 | 2 |
| 26 | Screw-Phillips, 4mx0.7x8mm | | | 9545-064-001 | 9545-064-001 | 4 |
| 27 | Shield, Water Valves | 9550-194-001 | 9550-194-001 | 9550-195-001 | 9550-195-001 | 1 |
| 28 | Clip-Push | 9083-121-001 | 9083-121-001 | | | 3 |
| 28 | Clip-Push | | | 9083-121-001 | 9083-121-001 | 4 |
| 29 | Cap-Injector Assy | 0935-127-001 | 0935-127-001 | 0935-127-001 | 0935-127-001 | 1 |
| 30 | Clamp | 8654-117-014 | 8654-117-014 | 8654-117-014 | 8654-117-014 | 1 |
| 31 | Hose-Suds Overflow | 9242-463-004 | 9242-463-004 | 9242-463-004 | 9242-463-006 | 1 |
| 32 | Resistors (160 Ohm) | 9483-004-002 | 9483-004-003 | 9483-004-003 | 9483-004-003 | 2 |
| 33 | Screws #10-32x1/2" (Mounting) | 9545-012-008 | 9545-012-008 | 9545-012-008 | 9545-012-008 | 4 |
| 34 | Jumper Wires | 8220-117-002 | 8220-117-002 | 8220-117-002 | 8220-117-002 | 2 |

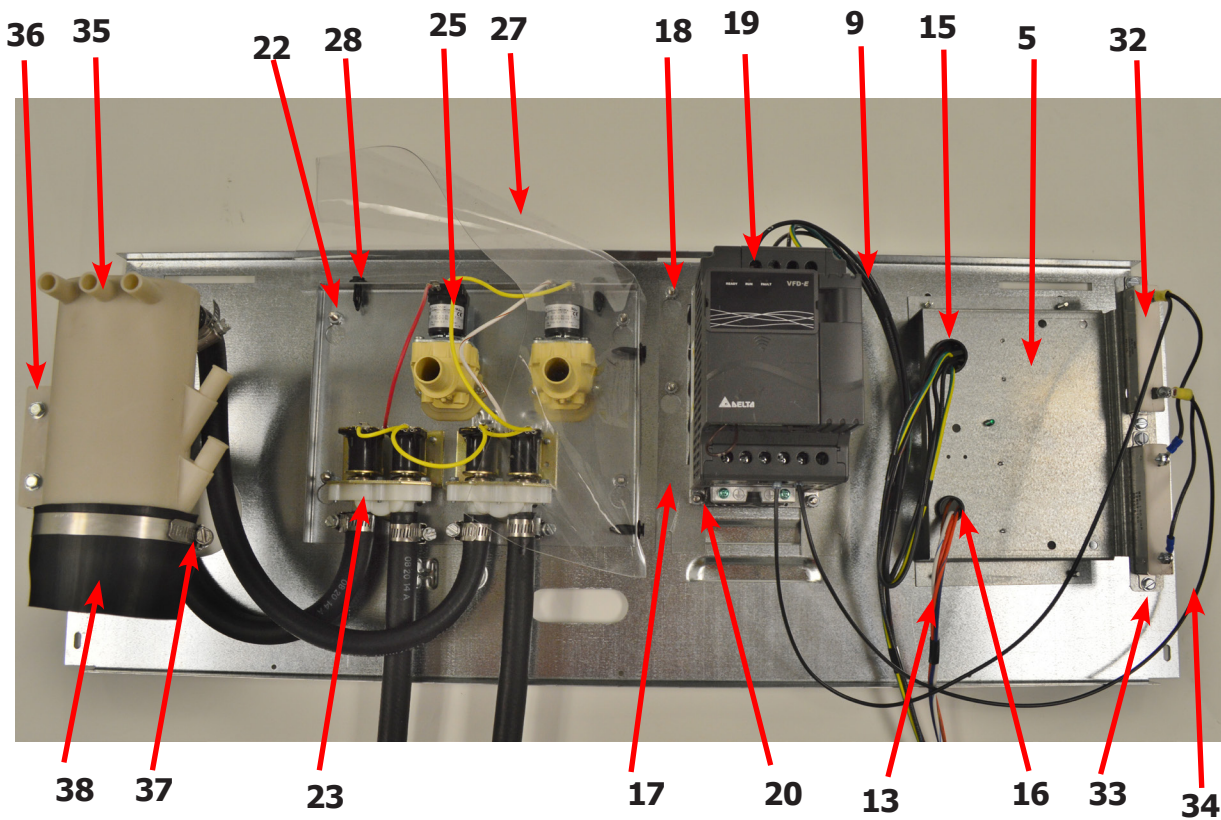
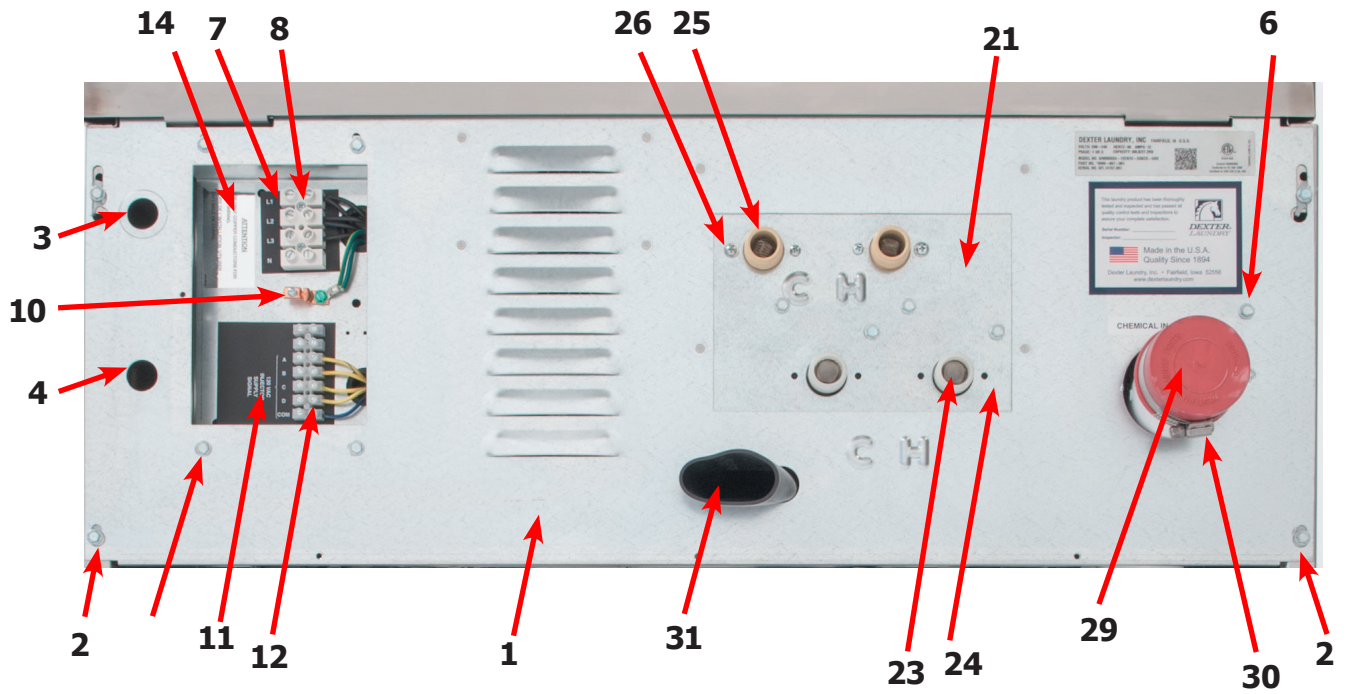

| Key | Description | T650 | T750 | T950 | T1450 | QTY |
|-----|--|--------------|--------------|--------------|--------------|-----|
| 35 | Vacuum Breaker | 9610-001-001 | 9610-001-001 | 9610-001-001 | 9610-001-001 | 1 |
| * | Bracket-Vacume Breaker | 9029-077-001 | 9029-077-001 | 9029-077-001 | 9029-266-001 | 1 |
| 36 | Screw, 10Bx1/2 | 9545-008-026 | 9545-008-026 | 9545-008-026 | 9545-008-026 | 4 |
| 37 | Clamp, Vacuum Breaker End | 8654-117-014 | 8654-117-014 | 8654-117-014 | 8654-117-014 | 1 |
| 38 | Hose, Vacuum Breaker to Tub Injection Tube | 9242-461-001 | 9242-461-001 | 9242-461-001 | 9242-461-001 | 1 |

Cylinder, Seals & Bearings Part # by Model

| Key | Description | T650 | T750 | T950 | T1450 | QTY |
|-----|--|--------------|--------------|--------------|---------------|-----|
| 1 | Housing, Bearing- Assembly (items #2-#6) | 9803-187-001 | 9803-187-001 | 9803-187-001 | 9803-209-001 | 1 |
| 2 | Housing, Bearing | 9241-181-004 | 9241-181-004 | 9241-181-004 | 9241-195-003 | 1 |
| 3 | Bearing, Front (LARGE) | 9036-159-006 | 9036-159-006 | 9036-159-006 | 9036-162-002 | 1 |
| 4 | Bearing, Rear (SMALL) | 9036-159-005 | 9036-159-005 | 9036-159-005 | 9036-162-001 | 1 |
| 5 | Spacer, Bearing | 9538-170-001 | 9538-170-001 | 9538-170-001 | 9538-185-001 | 1 |
| 6 | Ring, Bearing Retainer | 9487-238-004 | 9487-238-004 | 9487-238-004 | 9487-238-004 | 1 |
| 7 | Tub Assembly | 9930-168-001 | 9930-148-001 | 9930-157-001 | 9930-155-001 | 1 |
| 8 | Seal, Primary V85A | 9532-140-007 | 9532-140-007 | 9532-140-007 | | 1 |
| 8 | Seal, Primary V95A | | | | 9532-140-012 | 1 |
| 9 | Seal, Secondary V140A | 9532-140-008 | 9532-140-008 | 9532-140-008 | 9532-140-008 | 1 |
| 10 | Ring, Seal Mounting | 9950-052-001 | 9487-261-004 | 9950-052-001 | 9950-062-001 | 1 |
| 11 | Tub Back Mating Ring | 9487-266-001 | 9487-266-001 | 9487-266-001 | 9487-276-001? | 1 |
| 11G | Mating Ring Guard Shield | 9487-261-004 | 9487-261-004 | 9487-261-004 | 9487-261-005 | 1 |
| 12 | Bolt, Tub End of Bearing Housing (7/16-14x1), Bolt from inside Tub | 9545-059-004 | 9545-059-004 | 9545-059-004 | 9545-059-004 | 6 |
| 13 | Washer, Flat | 8641-581-034 | 8641-581-034 | 8641-581-034 | 8641-581-034 | 6 |
| 14 | Screw-Hex Cap, 3/4"-10 x 3" (Bearing Housing to Frame) | 9545-057-002 | 9545-057-002 | 9545-057-002 | | 6 |
| 14 | Screw-Hex Cap, 7/8"-10 x 3" (Bearing Housing to Frame) | | | | 9545-066-001 | 6 |
| 15 | Washers Spherical 3/4 (Male half) (Bearing Housing to Frame) | 8641-588-001 | 8641-588-001 | 8641-588-001 | | 6 |
| 15 | Washers Spherical 7/8 (Male half) (Bearing Housing to Frame) | | | | 8641-588-003 | 6 |
| 16 | Washers Spherical 3/4 (Female half) (Bearing Housing to Frame) | 8641-588-002 | 8641-588-002 | 8641-588-002 | | 6 |
| 16 | Washers Spherical 7/8 (Female half) (Bearing Housing to Frame) | | | | 8641-588-004 | 6 |
| 15 | Washer, Flat | | | | | 6 |
| 16 | Lock Washer-Extrenal Tooth, 3/4" (Bearing Housing to Frame) | | | | | 6 |
| 17 | Nut 3/4"-10 (Bearing Housing to Frame) | 8640-418-003 | 8640-418-003 | 8640-418-003 | | 6 |
| 17 | Nut 7/8"-9 (Bearing Housing to Frame) | | | | 8640-437-001 | 6 |
| 18 | Pulley, Driven | 9453-173-002 | 9453-173-002 | 9453-176-005 | 9453-176-005 | 1 |
| * | Tolerance Ring | 9487-234-004 | 9487-234-004 | | | 1 |
| * | Screw, 5/8"-11 x 2" | 9545-060-004 | 9545-060-004 | | | 1 |
| * | Washer-Flat, 5/8" | 8641-581-032 | 8641-581-032 | | | 1 |
| * | Washer-Flat, 5/8" | 8641-582-018 | 8641-582-018 | | | 1 |
| 19 | Bolt, 3/8"-16 x 2" | | | 9545-029-011 | 9545-029-011 | 3 |
| 20 | Washer, 3/8" | | | 8641-582-003 | 8641-582-003 | 3 |
| 21 | Bushing Taperlock (Driven & Large) | | | 9053-078-002 | 9053-078-002 | 1 |
| 22 | Washer-Flat .675x2-1/2x1/4 | | | 8641-581-043 | | 1 |
| 23 | Lockwasher-Exttooth, 5/8 | | | 8641-582-018 | | 1 |
| 24 | Bolt, 5/8-11x1 1/2 | | | 9545-060-001 | | 1 |
| 22 | Washer-Flat, .781x2-1/2x1/4 | | | | 8641-581-044 | 1 |
| 23 | Lockwasher-Exttooth, 3/4 | | | | 8641-582-020 | 1 |
| 24 | Bolt, 3/4-10-1 1/2 | | | | 9545-057-004 | 1 |
| 25 | Tub & Cylinder Assy | 9869-035-002 | 9869-025-001 | 9869-027-003 | 9869-026-001 | 1 |

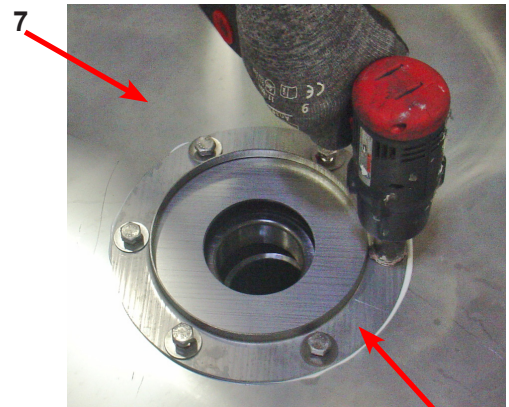
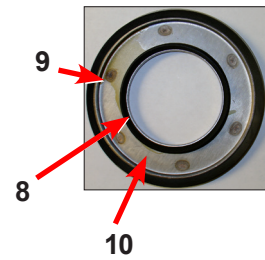
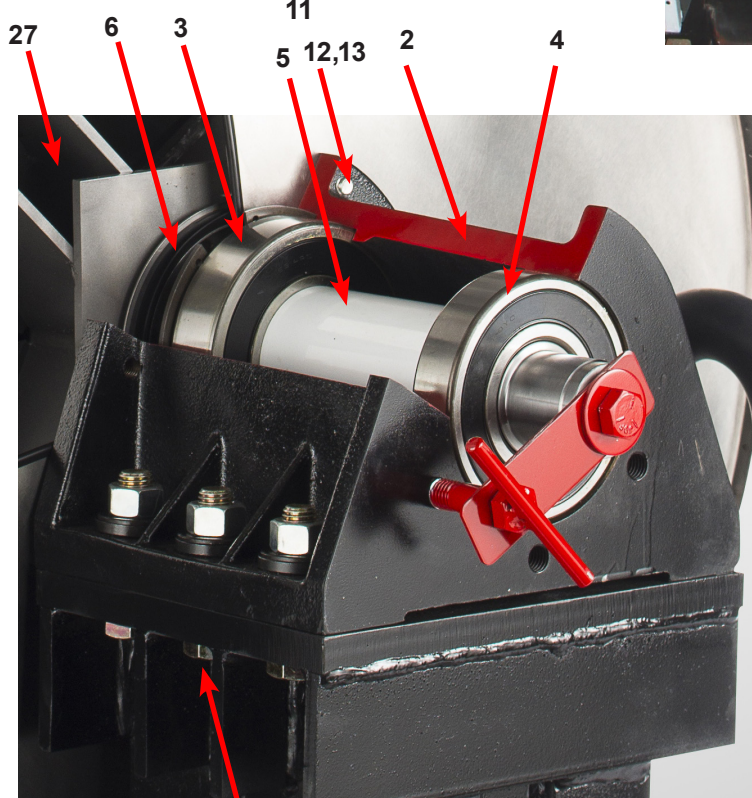
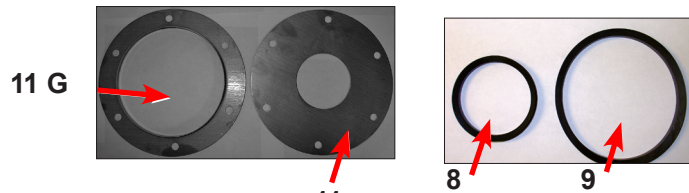
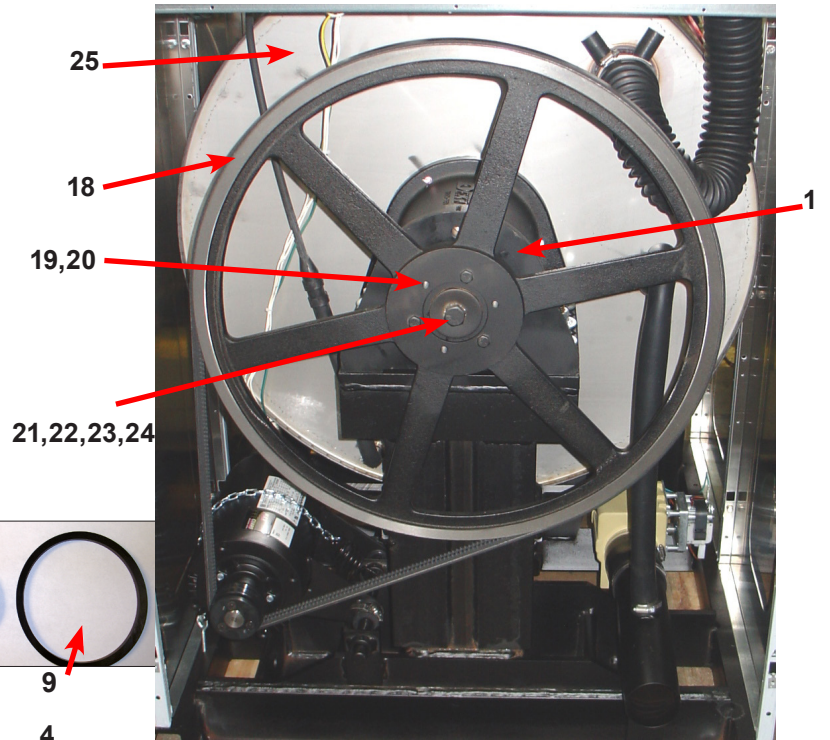
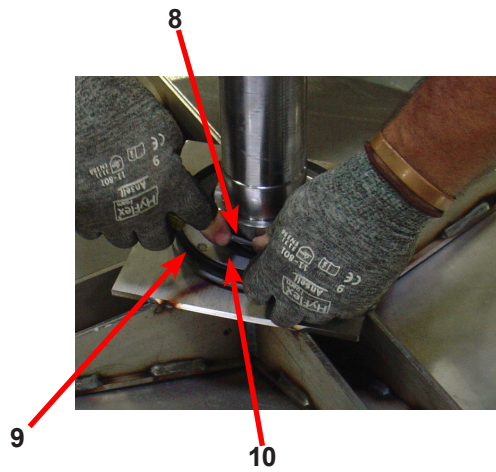

14,15,16,17

11

| Key | Description | T-650 | T750 | T950 | T1450 | QTY |
|-----|-----------------------------------|--------------|--------------|--------------|--------------|-----|
| 27 | Cylinder Assy | 9848-145-001 | 9848-136-002 | 9848-136-001 | 9848-141-001 | |
| * | Tub Front | 9974-014-002 | 9974-011-001 | 9974-011-001 | 9974-012-001 | 1 |
| * | Gasket, Tub Front | 9206-421-002 | 9206-421-002 | 9206-421-002 | 9206-421-002 | 1 |
| * | Ring Assy, Tub Mtg-Front Clamp | 9950-063-001 | 9950-055-001 | 9950-055-001 | 9950-061-001 | 1 |
| * | Bolt, Top Front Ring 3/8"-16 x 3" | 9545-029-009 | 9545-029-009 | 9545-029-009 | 9545-029-009 | 1 |
| * | Nut WCAD 3/8"-16 | 8640-415-001 | 8640-415-001 | 8640-415-001 | 8640-415-001 | 1 |

Door Lock Assembly (All Models)

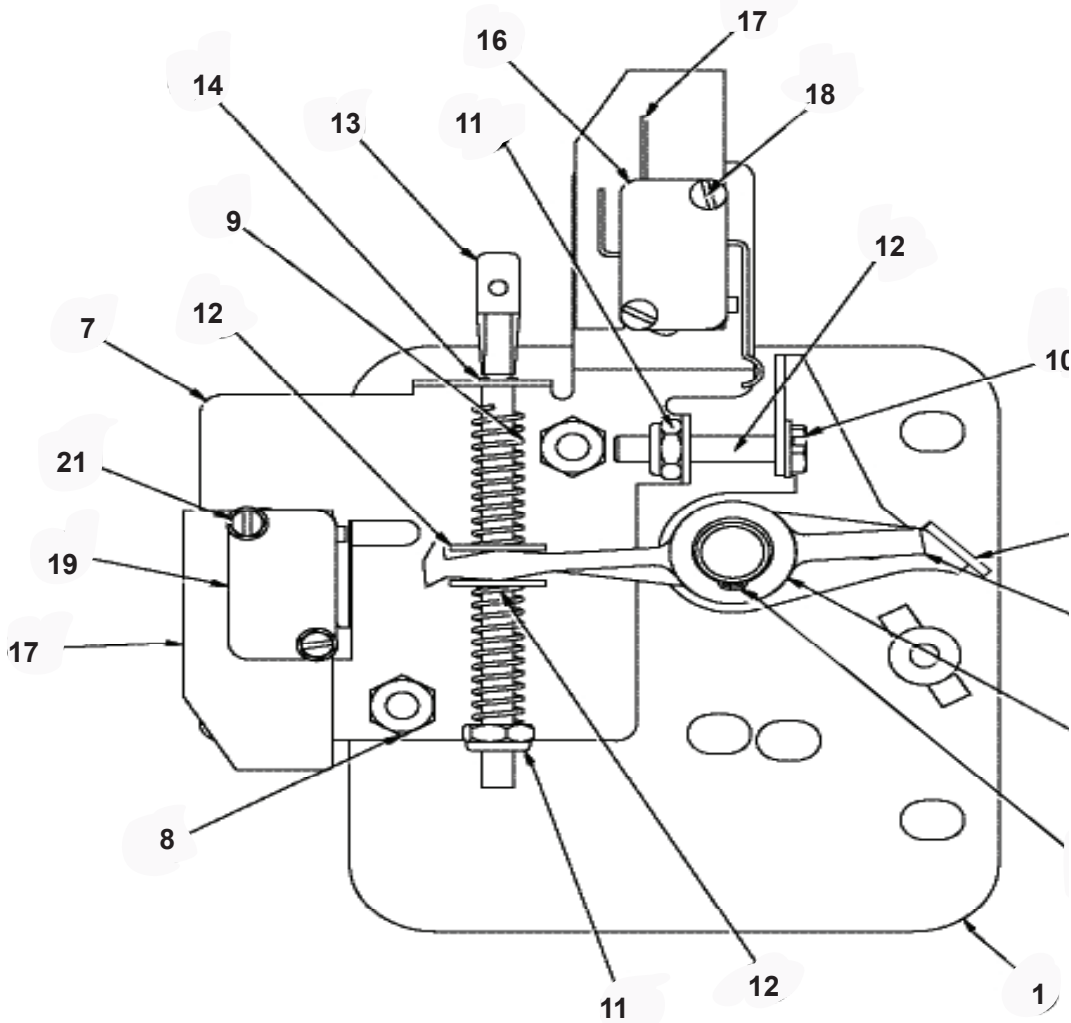

| Key | Description | All Models | QTY |
|-----|---|--------------|-----|
| 33 | Lock Assy, Complete (#1-22) (includes #1 thru #22) | 9885-024-001 | 1 |
| 1 | Plate Assy, Door Lock | 9982-346-001 | 1 |
| 2 | Washer, Flat (SS or Brass) | 8641-581-030 | 1 |
| 3 | Actuator, Latching Switch | 9008-005-001 | 1 |
| 4 | Pawl, Locking | 9450-002-004 | 1 |
| 5 | Washer, Spring | 8641-569-003 | 1 |
| 6 | Ring, Retaining | 9487-200-004 | 1 |
| 7 | Bracket Switch | 9029-163-001 | 1 |
| 8 | Nut, Hex 10-32 UNF | 8640-413-002 | 2 |
| 9 | Spring, Actuating | 9534-364-002 | 1 |
| 10 | Screw, Hx. 10-32 x 1" | 9545-012-020 | 1 |
| 11 | Nut, Elastic Stop 10-32 | 8640-413-004 | 2 |
| 12 | Spring, Return | 9534-364-001 | 2 |
| 13 | Pin, Guide | 9451-193-001 | 1 |

| Key | Description | All Models | QTY |
|-----|--------------------------------|--------------|-----|
| 14 | Ring, Retaining | 9487-200-005 | 1 |
| 15 | Washer | 8641-581-031 | 1 |
| 16 | Switch, Latching Sensing | 9539-461-008 | 1 |
| 17 | Shield, Switch | 9550-169-003 | 3 |
| 18 | Screw 4-40 x 5/8" | 9545-020-001 | 2 |
| 18 | Nut, Twin | 8640-401-001 | 2 |
| 19 | Switch, Locking Sensing | 9539-461-007 | 2 |
| 20 | Actuator, Switch Locking | 9008-006-003 | 1 |
| 21 | Screw 4-40 x 1 1/8" | 9545-020-003 | 2 |
| 21 | Spacer Sensor | 9538-182-001 | 1 |
| 22 | Pin, Dowel (for door cam) | 9451-181-004 | 1 |
| * | Shim, Door Lock, Thin | 9552-037-001 | AR |
| * | Screw, Lock mtg 1/4"-20 x 3/4" | 9545-018-014 | 3 |
| * | Lockwasher 1/4" Ext tooth | 8641-582-007 | 3 |

Gear Motor Door Lock Assembly

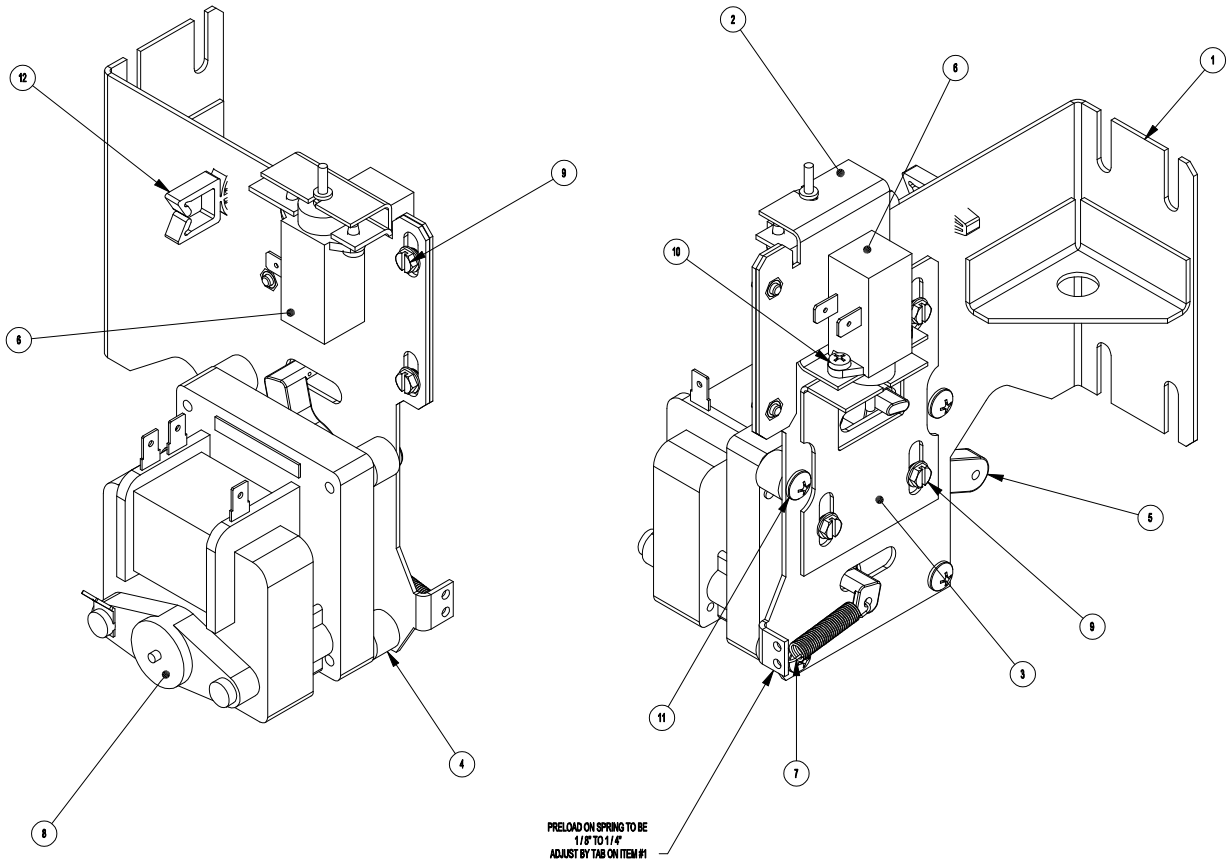

| Key | Description | T650 | T750 | T950 | T1450 | QTY |
|-----|---|--------------|--------------|--------------|--------------|-----|
| * | Actuator Assembly (Includes 1-10, Rod NOT included) | 9892-014-001 | 9892-014-001 | 9892-014-001 | 9892-014-001 | 1 |
| 11 | Screw Pnhdcr, 10-32 UNFx0 .75 | 9545-012-027 | 9545-012-027 | 9545-012-027 | 9545-012-027 | 4 |
| 10 | Cross Recessed PAn Hd Tapping screw | 9545-031-011 | 9545-031-011 | 9545-031-011 | 9545-031-011 | 4 |
| 9 | Screw -Hxwshrhdslems, 6-32 x 3/16 | 9545-044-003 | 9545-044-003 | 9545-044-003 | 9545-044-003 | 6 |
| 8 | Motor & Gear Assembly 120v | 9914-137-015 | 9914-137-015 | 9914-137-015 | 9914-137-015 | 1 |
| 7 | Spring - Extension | 9534-350-001 | 9534-350-001 | 9534-350-001 | 9534-350-001 | 1 |
| 6 | Thermoactuator - Door Lock Relay 120v | 9586-001-001 | 9586-001-001 | 9586-001-001 | 9586-001-001 | 2 |
| 5 | Arm - Door Lock | 9001-063-001 | 9001-063-001 | 9001-063-001 | 9001-063-001 | 1 |
| 4 | Spacer, Plastic | 9538-157-021 | 9538-157-021 | 9538-157-021 | 9538-157-021 | 4 |
| 3 | Bracket Slide Lock | 9029-204-001 | 9029-204-001 | 9029-204-001 | 9029-204-001 | 1 |
| 2 | Bracket Assy, Slide - Unlock | 9985-189-001 | 9985-189-001 | 9985-189-001 | 9985-189-001 | 1 |
| 1 | Bracket Assy, Slide Lock Actuator | 9985-190-001 | 9985-190-001 | 9985-190-001 | 9985-190-001 | 1 |
| * | Rod, Door Lock | 9497-225-017 | 9497-225-013 | 9497-225-015 | 9497-225-016 | 1 |

Large Door & Hinge Group

(After #514975)

| Key | Description | T650 | T750 | T950 | T1450 | QTY |
|-----|---|--------------|--------------|--------------|--------------|-----|
| 1 | Door Hinge Assembly (mounts to tub front) | 9955-030-001 | 9955-031-001 | 9955-031-001 | 9955-031-001 | 1 |
| * | Door Assembly Complete | 9960-309-001 | 9960-310-001 | 9960-310-001 | 9960-310-001 | 1 |
| 2 | Door Ring 180 degree large hnge | 9487-265-002 | 9487-275-001 | 9487-275-001 | 9487-275-001 | 1 |
| 3 | Door Gasket | 9206-419-001 | 9206-431-001 | 9206-431-001 | 9206-431-001 | 1 |
| 4 | Door Glass Window | 9635-016-001 | 9635-020-001 | 9635-020-001 | 9635-020-001 | 1 |
| * | Red Wire (Door Close Switch) | 8220-063-025 | 8220-063-028 | 8220-063-028 | 8220-063-028 | 1 |
| | Black Wire (Door Close Switch) | 8220-063-026 | 8220-063-029 | 8220-063-029 | 8220-063-029 | 1 |
| 5 | Switch, Door Hinge Close (Plunger) | 9539-492-001 | 9539-492-001 | 9539-492-001 | 9539-492-001 | 1 |
| 6 | Top Door Hinge Leaf (No pin) | 9845-008-001 | 9845-006-001 | 9845-006-001 | 9845-006-001 | 1 |
| 7 | Bottom Door Hinge Leaf | 9845-005-001 | 9845-007-001 | 9845-007-001 | 9845-007-001 | 1 |
| 8 | Thrd Form Screw, Door Mtg 5/16" x 5/8" | 9545-056-002 | | | | 3 |
| 8 | Thrd Form Screw, Door Mtg 5/16" x 5/8" | | 9545-056-002 | 9545-056-002 | 9545-056-002 | 4 |
| 9 | Screw, Loading Door Hinge Mtg (5/16" x9/16" ss) | 9545-014-009 | 9545-014-013 | 9545-014-013 | 9545-014-013 | 3 |
| 10 | Bracket Retainer support side panel | 9045-094-001 | 9045-085-001 | 9046-085-001 | 9046-085-001 | 1 |
| * | Shim Large door | 9552-043-001 | 9552-043-001 | 9552-043-001 | 9552-043-001 | 1 |

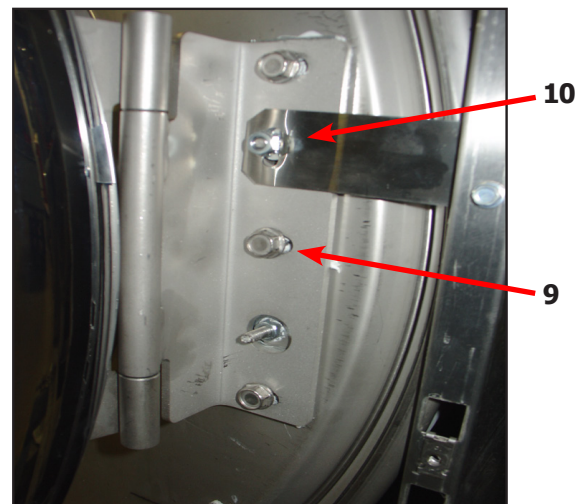

| Key | Description | T650 | T750 | T950 | T1450 | QTY |
|-----|---------------------------------|--------------|--------------|--------------|--------------|-----|
| * | Shaft Assembly (includes 11-13) | 9913-134-003 | 9913-134-003 | 9913-134-003 | 9913-134-003 | |
| 11 | Shaft, Door Locking | 9537-195-002 | 9537-195-002 | 9537-195-002 | 9537-195-002 | 1 |
| 12 | Cam, Locking | 9095-040-002 | 9095-040-002 | 9095-040-002 | 9095-040-002 | 1 |
| 13 | Pin, Groove (1 1/4) | 9451-181-005 | 9451-181-005 | 9451-181-005 | 9451-181-005 | 1 |
| 14 | Pin, Groove (3/4) | 9451-181-004 | 9451-181-004 | 9451-181-004 | 9451-181-004 | 1 |
| 15 | Spring, Lock Cam | 9534-360-002 | 9534-360-002 | 9534-360-002 | 9534-360-002 | 1 |
| 16 | Handle, Door | 9244-091-001 | 9244-091-001 | 9244-091-001 | 9244-091-001 | 1 |
| 17 | Pin, Door Handle (groove) | 9451-181-005 | 9451-181-005 | 9451-181-005 | 9451-181-005 | 1 |

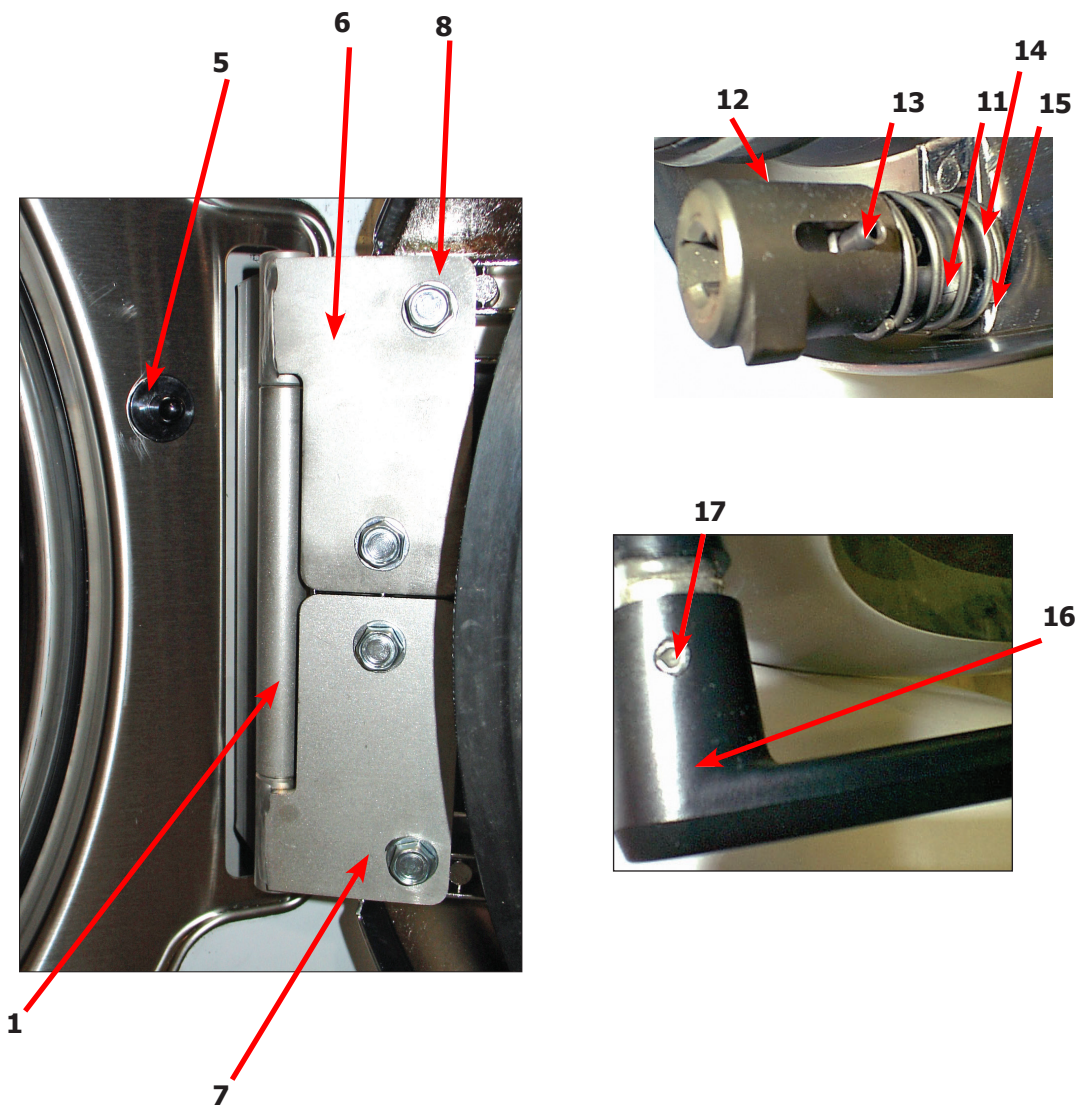

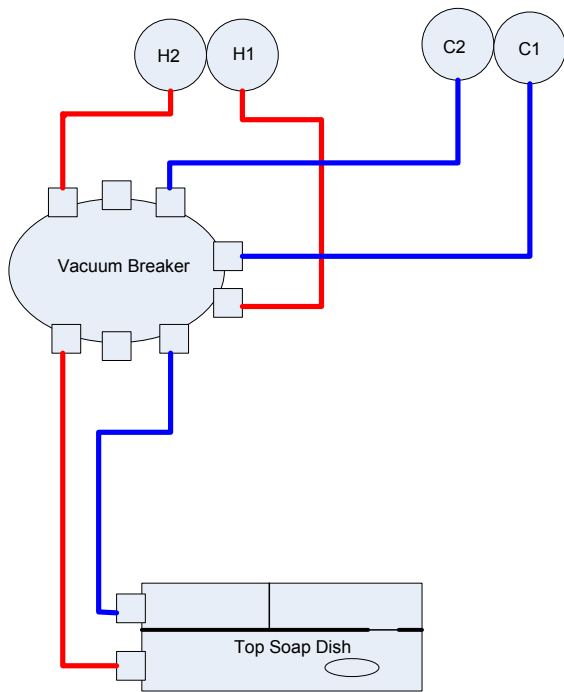
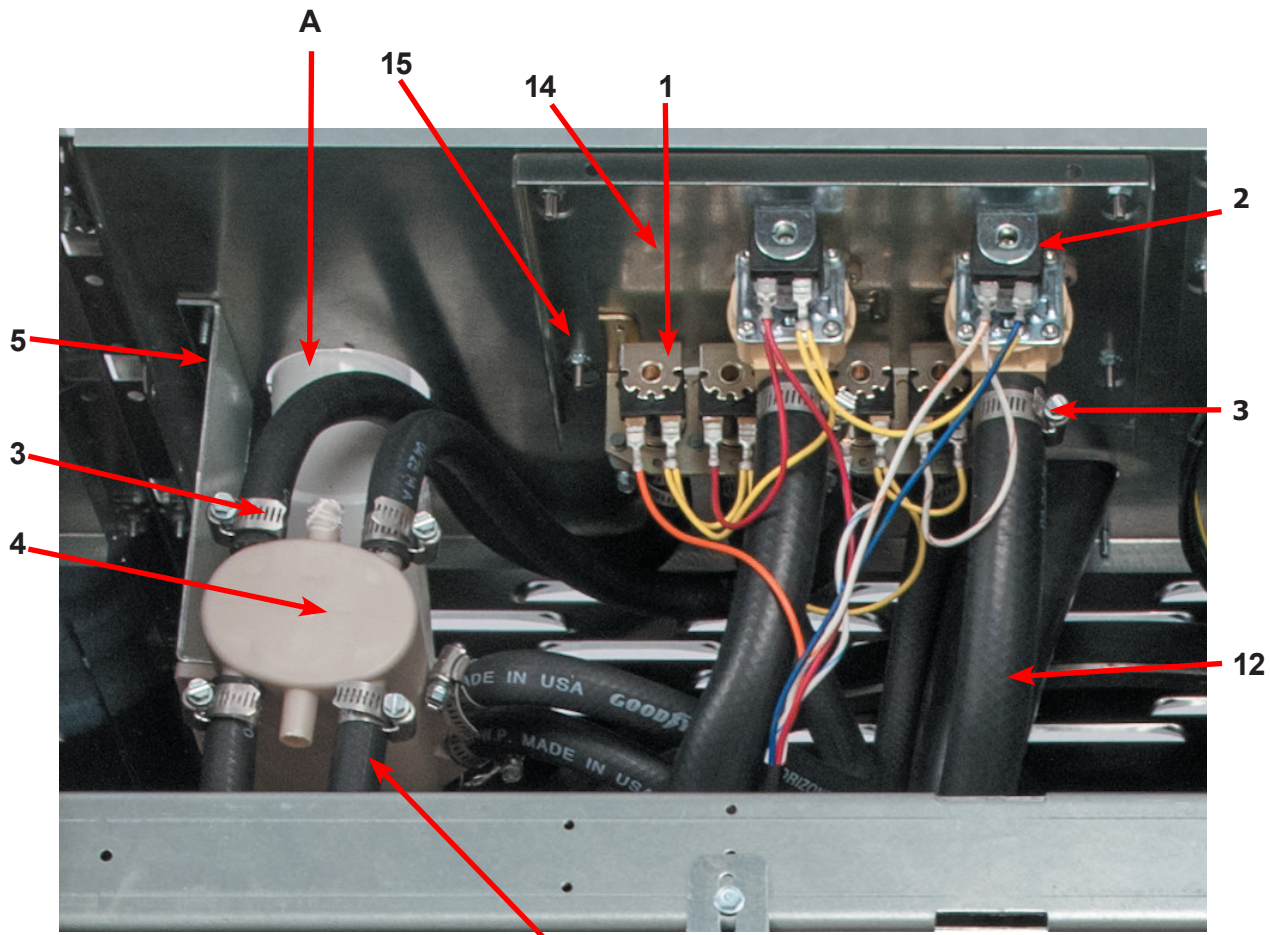

Top Soap Box Design

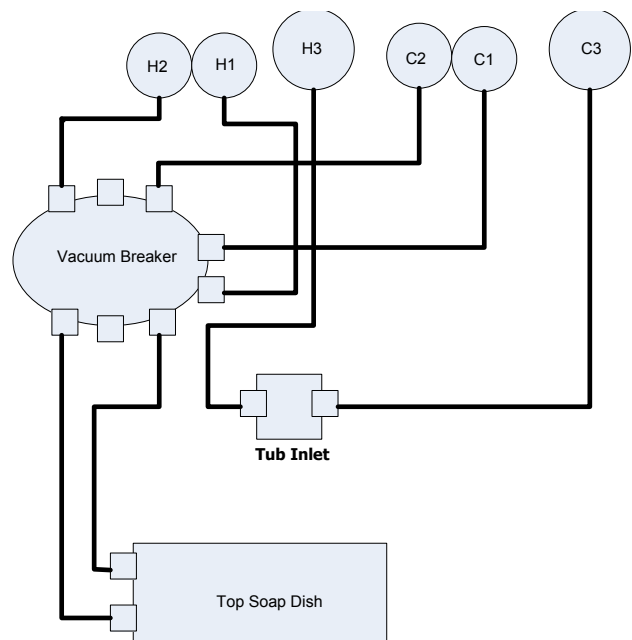

Top Soap Box 4 Valve Design

Water Inlet Part # by Model

| Key | Description | T650 | T 750 | T950 | T1450 | QTY |
|-----|---|--------------|--------------|--------------|--------------|-----|
| A | Injector Assembly | 9883-005-001 | 9883-005-001 | 9883-012-001 | 9885-011-001 | 1 |
| 1 | Valve, Water Inlet (dual outlet) (see Water Inlet Valve Breakdown for individual parts) | 9379-183-012 | 9379-183-012 | 9379-183-012 | 9379-183-012 | 2 |
| * | Screw, Valve Mtg | 9545-008-026 | 9545-008-026 | 9545-008-026 | 9545-008-026 | 2 |
| 2 | Valve Water Inlet (single outlet) | | | 9379-194-001 | 9379-194-001 | 2 |
| * | Screw, Valve M4x0.7x8mm | | | 9495-064-001 | 9545-064-001 | 8 |
| 3 | Clamp-Water Valves | 8654-117-008 | 8654-117-008 | 8654-117-008 | 8654-117-008 | AR |
| * | Shield over Water Valves Plastic | 9550-194-001 | 9550-194-001 | 9550-195-001 | 9550-186-001 | 1 |
| * | Clip-Push | 9083-121-001 | 9083-121-001 | | | 3 |
| * | Clip-Push | | | 9083-121-001 | 9083-121-001 | 4 |
| 4 | Vacuum Breaker | 9610-001-001 | 9610-001-001 | 9610-001-001 | 9610-001-001 | 1 |
| 5 | Bracket, Vacuum Breaker | 9029-077-001 | 9029-077-001 | 9029-077-001 | 9029-266-001 | 1 |
| * | Screw | 9545-008-026 | 9545-008-026 | 9545-008-026 | 9545-008-026 | 4 |
| 6 | New Front Mount Soap Box, 2 port | | | | 9732-290-001 | 1 |
| 7 | Fitting, Cross (new soap bhox) | | | | 8615-118-001 | |
| * | Clamp, Vacuum Breaker End | 8654-117-014 | 8654-117-014 | 8654-117-014 | 8654-117-014 | 1 |
| 9 | Hose, Vacuum Breaker to Tub Injection Tube | 9242-461-001 | 9242-461-001 | 9242-461-001 | 9242-461-001 | 1 |
| 10 | Flow restrictor | 9475-002-002 | 9475-002-002 | 9475-002-002 | 9475-002-002 | 2 |
| 11 | 1/2 inch hose, cut to length | | | | | |
| 12 | 3/4 inch hose, cut to length | | | | | |
| 13 | Flow restrictor | | | 9475-002-002 | 9475-002-003 | 3 |
| * | Tub Fill Inlet Cap | | | | | 2 |
| 14 | Plate-Water Valves, Mounting | 9452-813-001 | 9452-813-001 | 9452-814-001 | 9452-814-001 | 1 |
| 15 | Nut, #10-32UNF, 2B | 8460-413-002 | 8460-413-002 | 8460-413-002 | 8460-413-002 | 4 |

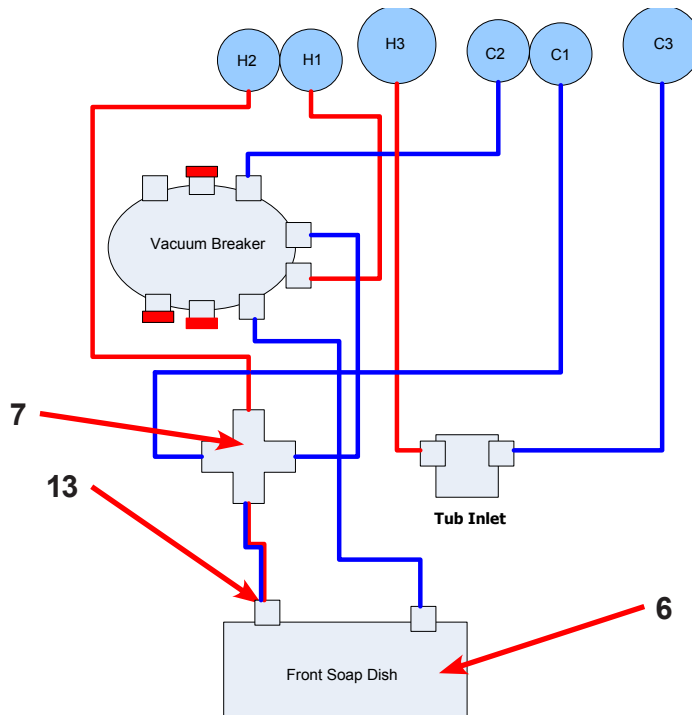

New Front Soap Box Design

Water Inlet Valve Breakdown Part # by Model

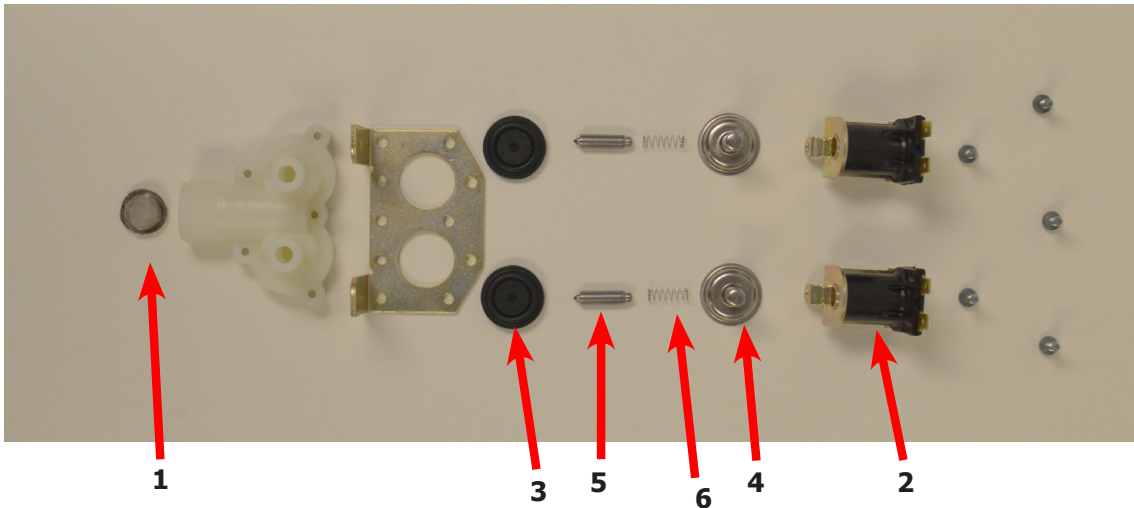

| Key | Description | T650 | T750 | T950 | T1450 | QTY |
|-----|--|--------------|--------------|--------------|--------------|-----|
| * | Valve, Water Inlet (includes 1 thru 6) | 9379-183-012 | 9379-183-012 | 9379-183-012 | 9379-183-012 | 2 |
| 1 | Screen, Inlet end of valve | 9555-056-001 | 9555-056-001 | 9555-056-001 | 9555-056-001 | 2 |
| 2 | Coil Assy., 120 V Invensys | 9089-017-001 | 9089-017-001 | 9089-017-001 | 9089-017-001 | 2 |
| * | Diaphragm Invensys (EPDM) | 9118-049-001 | 9118-049-001 | 9118-049-001 | 9118-049-001 | 2 |
| * | Diaphragm Invensys (Viton) | 9118-049-002 | 9118-049-002 | 9118-049-002 | 9118-049-002 | 2 |
| 3 | Diaphragm Invensys (EPDM NSF) | 9118-049-003 | 9118-049-003 | 9118-049-003 | 9118-049-003 | 2 |
| 4 | Guide, Solenoid Invensys | 9211-021-002 | 9211-021-002 | 9211-021-002 | 9211-021-002 | 2 |
| 5 | Armature Invensys | 9015-008-001 | 9015-008-001 | 9015-008-001 | 9015-008-001 | 2 |
| 6 | Spring, Armature Invensys | 9534-298-001 | 9534-298-001 | 9534-298-001 | 9534-298-001 | 2 |

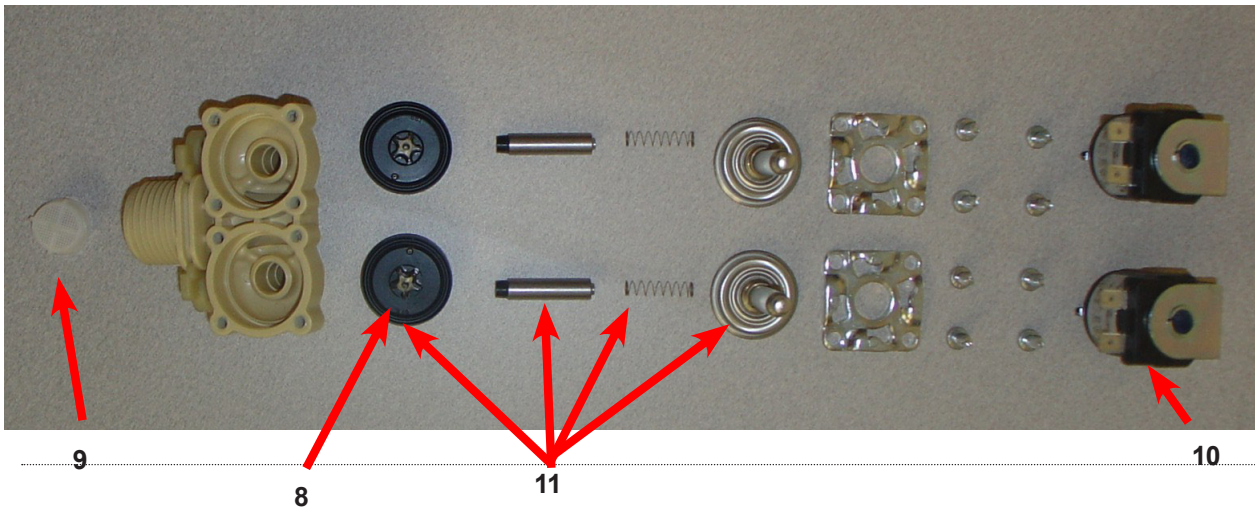

Optional Water Valve

| Key | Description | 650 | T750 | T950 | T1450 | QTY |
|-----|-------------------------------------|--------------|--------------|--------------|--------------|-----|
| * | Dual Coil Water Valve Mueller | 9379-192-001 | 9379-192-001 | 9379-192-001 | 9379-192-001 | 1 |
| 7 | Valve Water Body Complete(no coil) | 9379-192-002 | 9379-192-002 | 9379-192-002 | 9379-192-002 | 1 |
| 8 | Diaphragm Mueller | 9118-054-001 | 9118-054-001 | 9118-054-001 | 9118-054-001 | 2 |
| 9 | Filter Mueller | 9183-046-001 | 9183-046-001 | 9183-046-001 | 9183-046-001 | 2 |
| 10 | Coil Mueller | 9089-051-001 | 9089-051-001 | 9089-051-001 | 9089-051-001 | 2 |
| 11 | Diaphragm Assembly Mueller Includes | 9785-001-001 | 9785-001-001 | 9785-001-001 | 9785-001-001 | 2 |

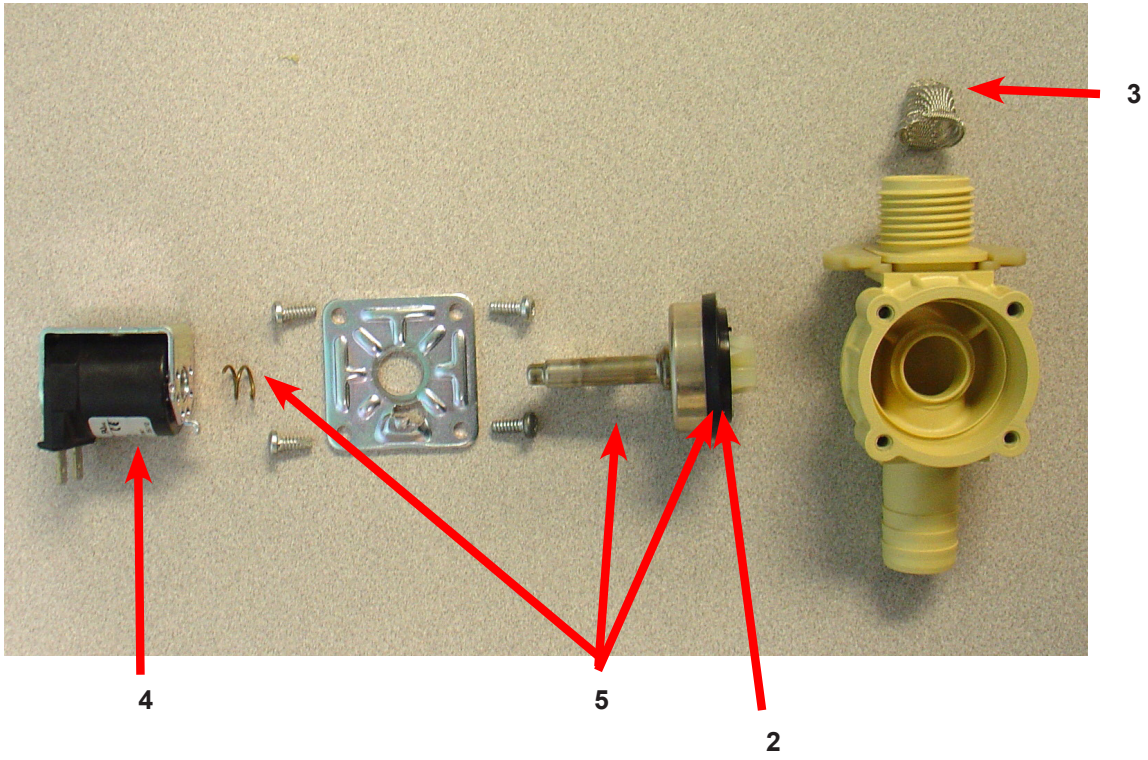

| Key | Description | T650 | T750 | T950 | T1450 | QTY |
|-----|-------------------------------------|------|------|--------------|--------------|-----|
| * | Single Coil Water Valve Mueller | | | 9379-194-001 | 9379-194-001 | 1 |
| 1 | Valve Water Body Complete (no coil) | | | 9379-194-002 | 9379-194-002 | 1 |
| 2 | Diaphragm Mueller | | | 9118-055-001 | 9118-055-001 | 1 |
| 3 | Filter Mueller | | | 9183-046-001 | 9183-046-001 | 1 |
| 4 | Coil Mueller | | | 9089-051-001 | 9089-051-001 | 1 |
| | | | | | | |

Drain Valve Group Part # by Model

| Key | Description | Part Number | Qty |
|-----|---|--------------|-----|
| 1 | Valve, Drain (includes #2 thru #11) | 9379-202-001 | 1 |
| 2 | Body, Valve (w/ball) | 9064-072-001 | 1 |
| 3 | Motor & Gear Train (complete) | 9914-137-023 | 1 |
| 4 | Plate, Motor Mtg | 9452-538-001 | 1 |
| 5 | Screw | 8639-994-001 | 1 |
| 6 | Spring, Drive | 9534-339-001 | 1 |
| 7 | Screw | 9545-054-001 | 1 |
| 8 | Screw | 9545-054-002 | 1 |
| 9 | Seal, V Packer | 9532-134-001 | 1 |
| 10 | Washer | 8641-584-001 | 1 |
| 11 | Pin, Main Drive | 9451-196-001 | 1 |
| * | Plate (spacers needed for replacement motor mtg. plate) | 9538-149-001 | 1 |
| 12 | Kit - Seal Replacement | 9732-327-001 | 1 |

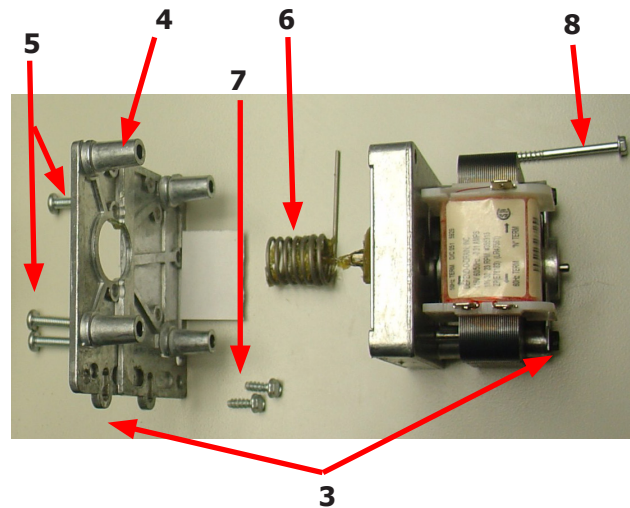
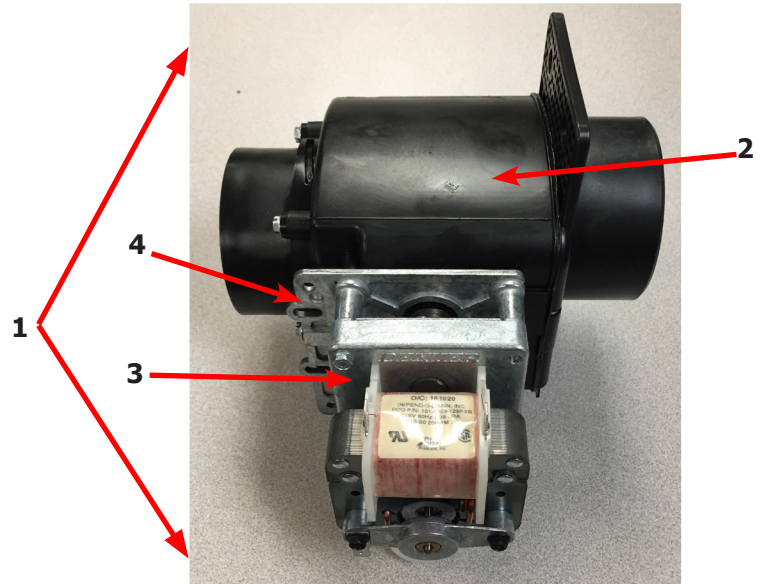
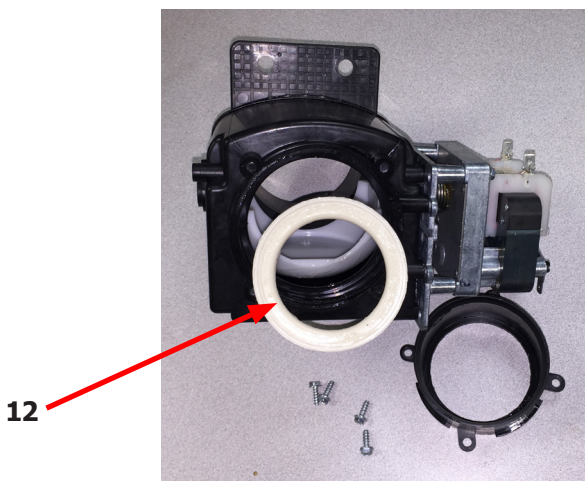

Chassis and Drain Part # by Model

| Key | Description | T-650 | T750 | T950 | T1450 | QTY |
|-----|---------------------------------------|--------------|--------------|--------------|--------------|-----|
| 1 | Base Assy,Frame | 9945-143-002 | 9945-112-002 | 9945-128-002 | 9945-133-002 | 1 |
| 2 | Outer Tub Assy. | 9930-168-001 | 9930-148-001 | 9930-157-001 | 9930-155-001 | 1 |
| * | Tub & Cylinder Assy. | 9869-035-002 | 9869-025-001 | 9869-027-003 | 9869-026-002 | 1 |
| 3 | Tub Front | 9974-014-002 | 9974-011-001 | 9974-011-001 | 9974-012-001 | 1 |
| * | Gasket, Tub Front | 9206-421-004 | 9206-421-002 | 9206-421-002 | 9206-421-002 | 1 |
| 4 | Ring Assy, Tub Mtg-Front Clamp | 9950-063-001 | 9950-055-001 | 9950-055-001 | 9950-061-001 | 1 |
| 5 | Bolt, Top Front Ring 3/8"-16 x 3" | 9545-029-009 | 9545-029-009 | 9545-029-009 | 9545-029-009 | 1 |
| 6 | Nut WCAD 3/8"-16 | 8640-415-001 | 8640-415-001 | 8640-415-001 | 8640-415-001 | 1 |
| 7 | Bolt, 1/2" -13 x 2" Rings to Base | 9545-017-013 | 9545-017-013 | 9545-017-013 | 9545-017-013 | 2 |
| 8 | Nut, Wizloc 1/2" x 13 | 8640-417-005 | 8640-417-005 | 8640-417-005 | 8640-417-005 | 2 |
| 9 | Washer, Flat 1/2" | 8641-581-026 | 8641-581-026 | 8641-581-026 | 8641-581-026 | 2 |
| 10 | Hose, Tub to Drain Valve | 9242-464-001 | 9242-456-001 | 9242-459-001 | 9242-459-001 | 1 |
| 11 | Clamp, Hose (Tub to Drain Valve) | 8654-117-014 | 8654-117-014 | 8654-117-014 | 8654-117-014 | 2 |
| 12 | Valve, Drain | 9379-202-001 | 9379-202-001 | 9379-202-001 | 9379-202-001 | 1 |
| * | Screw, Valve to Base 1/4ABx3/4 | 9545-030-002 | 9545-030-002 | 9545-030-002 | 9545-030-002 | 2 |
| * | Washer, Flat 1/4 | 8641-581-017 | 8641-581-017 | 8641-581-017 | 8641-581-018 | 2 |
| 13 | Hose, Drain Valve to Tube | 9242-457-001 | 9242-457-001 | 9242-457-001 | 9242-457-002 | 1 |
| * | Clamp, Hose (Drain Valve to Tube | 8654-117-014 | 8654-117-014 | 8654-117-014 | 8654-117-014 | 2 |
| 14 | Tube Assy, Drain | 9915-124-002 | 9915-124-002 | 9915-120-004 | 9915-129-002 | 1 |
| 15 | Clamp, Hose (Tube to Frame Bracket) | 8654-117-014 | 8654-117-014 | 8654-117-014 | 8654-117-014 | 1 |
| * | Bracket, Drain Tube | | | 9029-162-002 | | 1 |
| * | Screw Tube (Bracket to Base 1/4Bx3/4) | 9545-030-002 | 9545-030-002 | 9545-030-002 | | 4 |
| 16 | Hose, Overflow Tub To Drain Tube | 9242-449-002 | 9242-449-003 | 9242-449-003 | 9242-449-005 | 1 |
| * | Clamp, Hose | 8654-117-018 | 8654-117-018 | 8654-117-018 | 8654-117-018 | 2 |
| 17 | Tube, Suds overflow | 9242-463-004 | 9242-463-004 | 9242-463-004 | 9242-463-006 | 1 |
| * | Clamp, Hose | 8654-117-008 | 8654-117-008 | 8654-117-008 | 8654-117-008 | 2 |
| 18 | Hose, Pressure switch | 9242-175-004 | 9242-175-007 | 9242-175-007 | 9242-175-004 | 1 |
| | Clamp, Hose | 8654-117-015 | 8654-117-015 | 8654-117-015 | 8654-117-015 | 1 |
| | | | | | | |
| | | | | | | |
| | | | | | | |
| | | | | | | |
| | | | | | | |

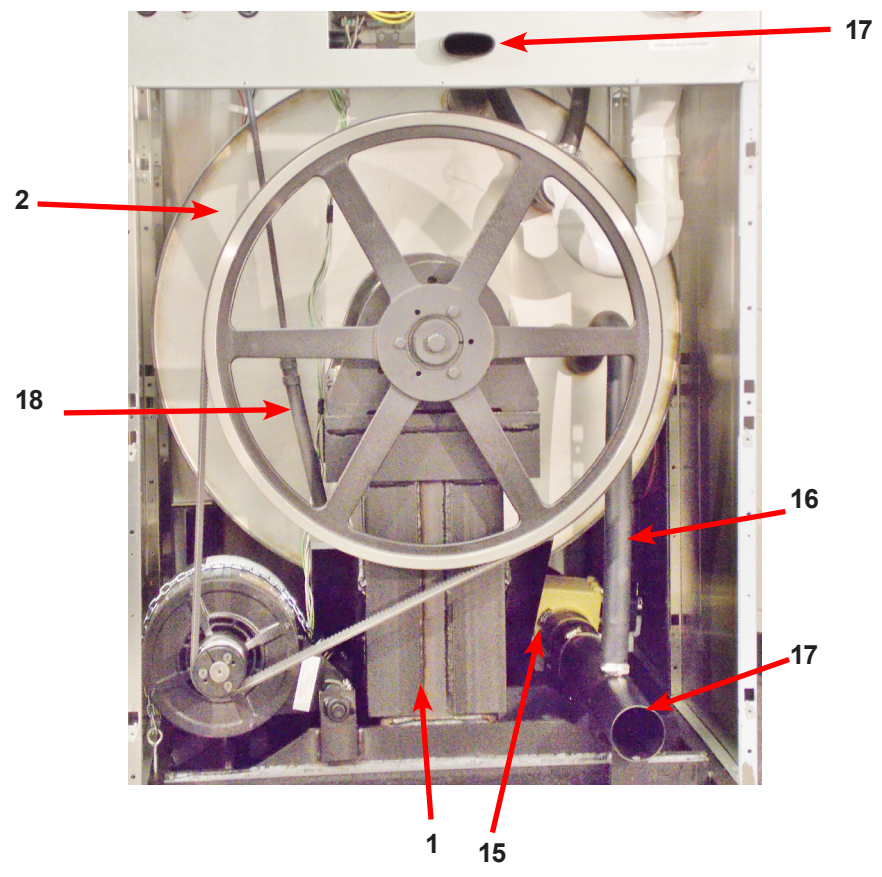
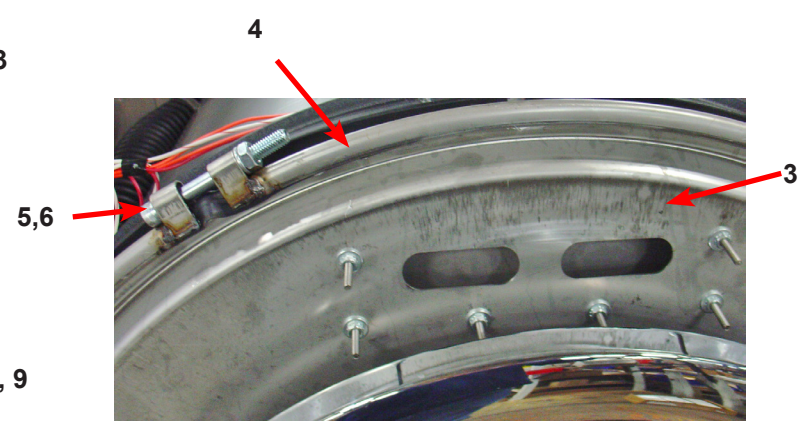
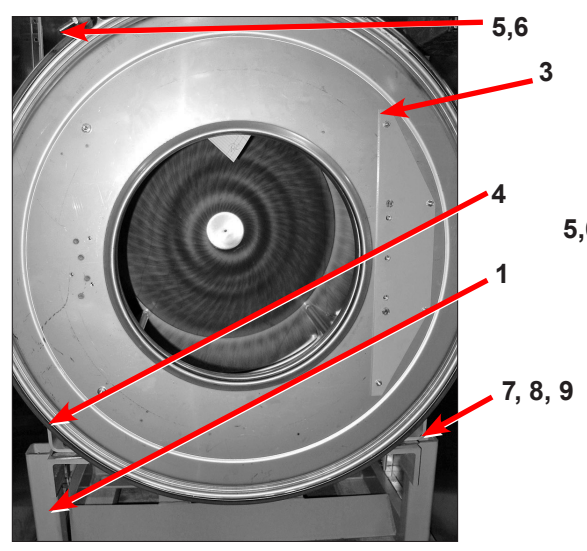
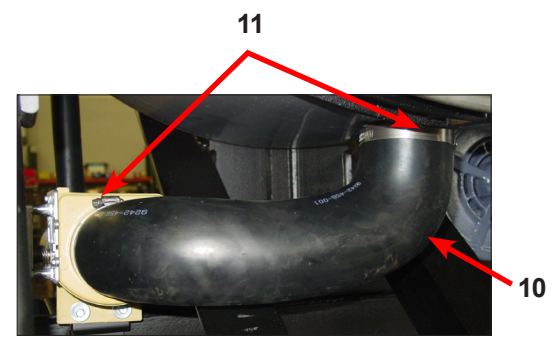
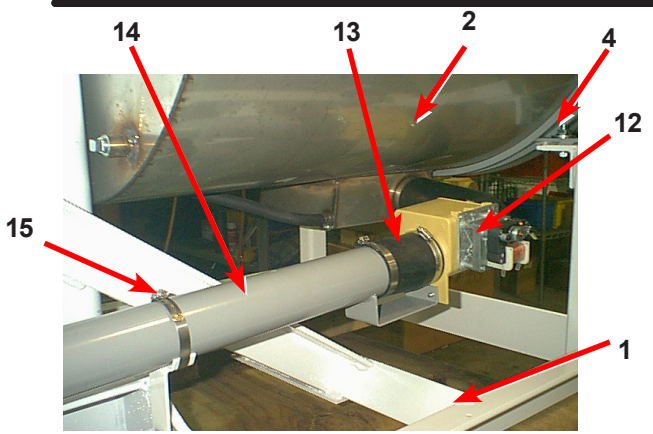

| Key | Description | T650 | T750 | T950 | T1450 | QTY |
|-----|--|--------------|--------------|--------------|--------------|-----|
| 1 | Trough Assy,Controls 208-240 volt (all parts below #2-#43) | 9857-221-001 | 9857-215-001 | 9857-216-002 | 9857-218-001 | 1 |
| * | Trough only | 9839-018-001 | 9839-018-001 | 9839-018-001 | 9839-017-001 | 1 |
| * | Screw, Trough Sides | 9545-008-026 | 9545-008-026 | 9545-008-026 | 9545-008-026 | 4 |
| * | Lockwasher Exttooth #10 | 8641-582-006 | 8641-582-006 | 8641-582-006 | 8641-582-006 | 4 |
| * | Angle Support Trough | 9003-278-001 | 9003-278-001 | 9003-271-001 | | 1 |
| * | Screw, Trough Bracket | 9545-008-026 | 9545-008-026 | 9545-008-026 | 9545-008-026 | 4 |
| * | Channel-Trough Mounting | 9081-136-001 | 9081-136-001 | 9081-108-001 | 9801-155-001 | 1 |
| * | Screw-10Bx1/2 | 9545-008-026 | 9545-008-026 | 9545-008-026 | 9545-008-026 | 4 |
| 2 | Screw GRN. #10-32x 1/2" | 8639-621-007 | 8639-621-007 | 8639-621-007 | 8639-621-007 | 1 |
| * | Lockwasher #10 | 8641-582-006 | 8641-582-006 | 8641-582-006 | 8641-582-006 | 1 |
| 3 | Transformer, Control (Secondary Voltage to 115 volts) | 8711-004-001 | 8711-004-001 | 8711-004-001 | 8711-004-001 | 1 |
| 4 | Screw, Mtg #8Bx1/4" | 9545-008-026 | 9545-045-001 | 9545-045-001 | 9545-045-001 | 4 |
| * | Lockwasher #10 | 8641-582-006 | 8641-582-006 | 8641-582-006 | 8641-582-006 | 4 |
| 5 | Terminal Block Assy, POWER | 9897-026-004 | 9897-026-004 | 9897-026-004 | 9897-026-004 | 1 |
| * | Screw, Mtg 8Bx3/8" | 9545-045-012 | 9545-045-007 | 9545-045-007 | 9545-045-007 | 2 |
| 6 | Transformer, (Step Down) 120/2.3 VAC&24 VAC 50/60hz | 8711-009-001 | 8711-009-001 | 8711-009-001 | 8711-009-001 | 1 |
| * | Lockwasher #10 exttooth | 8641-582-005 | 8641-582-005 | 8641-582-005 | 8641-582-005 | 4 |
| 7 | Screw, Mtg #10Bx1/2" | 9545-045-001 | 9545-045-001 | 9545-045-001 | 9545-045-001 | 4 |
| 8 | PCB assembly Relay Main | 9473-006-001 | 9473-006-001 | 9473-006-001 | 9473-006-001 | 1 |
| * | Support-3/8" Edge Holding | 9548-285-001 | 9548-285-001 | 9548-285-001 | 9548-285-001 | 6 |
| 9 | Bushing , Wire 7/8 | 9053-067-002 | 9053-067-002 | 9053-067-002 | 9053-067-002 | 2 |
| * | Wire Assy, Enable-Yellow 32" | 8220-064-023 | 8220-064-023 | 8220-064-023 | 8220-064-023 | 2 |
| 10 | Harness, P17 Drain/Therm/Sol | 9627-796-002 | 9627-796-002 | 9627-796-002 | 9627-796-002 | 1 |
| 11 | Harness P19/Water Valve | 9627-795-004 | 9627-795-004 | 9627-795-004 | 9627-795-004 | 1 |
| * | Harness P8/P16 , Control | 9627-794-001 | 9627-794-001 | 9627-794-004 | 9627-794-001 | 1 |
| 12 | Harness P20/P21, Enable | 9627-793-001 | 9627-793-001 | 9627-793-001 | 9627-793-001 | 1 |
| 13 | Optional Relay board | 9473-007-001 | 9473-007-001 | 9473-007-001 | 9473-007-001 | 1 |
| 14 | Support-3/8" Edge Holding | 9548-285-001 | 9548-285-001 | 9548-285-001 | 9548-285-001 | 4 |
| 15 | Harness, P10 To Terminal Block | 9627-799-001 | 9627-799-001 | 9627-799-001 | 9627-799-001 | 1 |
| 16 | Harness, P15/P23 Injection | 9627-798-001 | 9627-798-001 | 9627-798-001 | 9627-798-001 | 1 |
| 17 | Switch, Pressure | | 9539-490-001 | 9539-490-001 | 9539-490-002 | 1 |
| 18 | Harness P5/Pressure | 9627-806-001 | 9627-807-001 | 9627-807-001 | 9627-900-001 | 1 |
| * | Standoff Twistlock | 9527-002-002 | 9527-002-002 | 9527-002-002 | 9527-002-002 | 4 |
| 19 | Fuse Holder Assy | 9200-001-002 | 9200-001-002 | 9200-001-002 | 9200-001-002 | 1 |
| * | Fuse, 1.5Amp | 8636-018-001 | 8636-018-001 | 8636-018-001 | | 1 |
| * | Fuse, 2.5Amp | | | | 8636-018-004 | 1 |
| 20 | Label-Fuse, 1.5Amp | 8502-716-001 | 8502-716-001 | 8502-716-001 | | 1 |
| 20 | Label-Fuse, 1.5Amp | | | | 8502-716-002 | 1 |
| * | Terminal Grounding, | 8652-130-037 | 8652-130-037 | 8652-130-037 | 8652-130-037 | 1 |
| * | Screw 10-32 x 1/2 GRN | 9545-008-027 | 9545-008-027 | 9545-008-027 | 9545-008-027 | 1 |
| * | Lockwasher, #10 | 8641-582-006 | 8641-582-006 | 8641-582-006 | 8641-582-006 | 1 |
| * | Kit-Pressure Sensor, Electronic | 9732-314-001 | 9732-314-001 | 9732-314-001 | 9732-314-001 | 1 |
| 21 | Kit-Repaacement, Pressure Sensor (only) | 9732-315-001 | 9732-315-001 | 9732-315-001 | 9732-315-001 | 1 |
| * | Support-PCB, 3/8", Edge Holding | 9458-285-001 | 9458-285-001 | 9458-285-001 | 9458-285-001 | 1 |
| 22 | Transformer-120/18VAC, 5 VA | 8711-015-001 | 8711-015-001 | 8711-015-001 | 8711-015-001 | 1 |
| 23 | Screw, 8B x 1/4 | 9545-045-001 | 9545-045-001 | 9545-045-001 | 9545-045-001 | 1 |
| * | Wire Assy BLK/BLU | 8220-001-233 | 8220-001-233 | 8220-001-233 | 8220-001-233 | 1 |
| * | Wire Assy RED/BLU | 8220-001-232 | 8220-001-232 | 8220-001-232 | 8220-001-232 | 1 |

Electrical Components - Top Compartment

Mechanical Pressure Switch

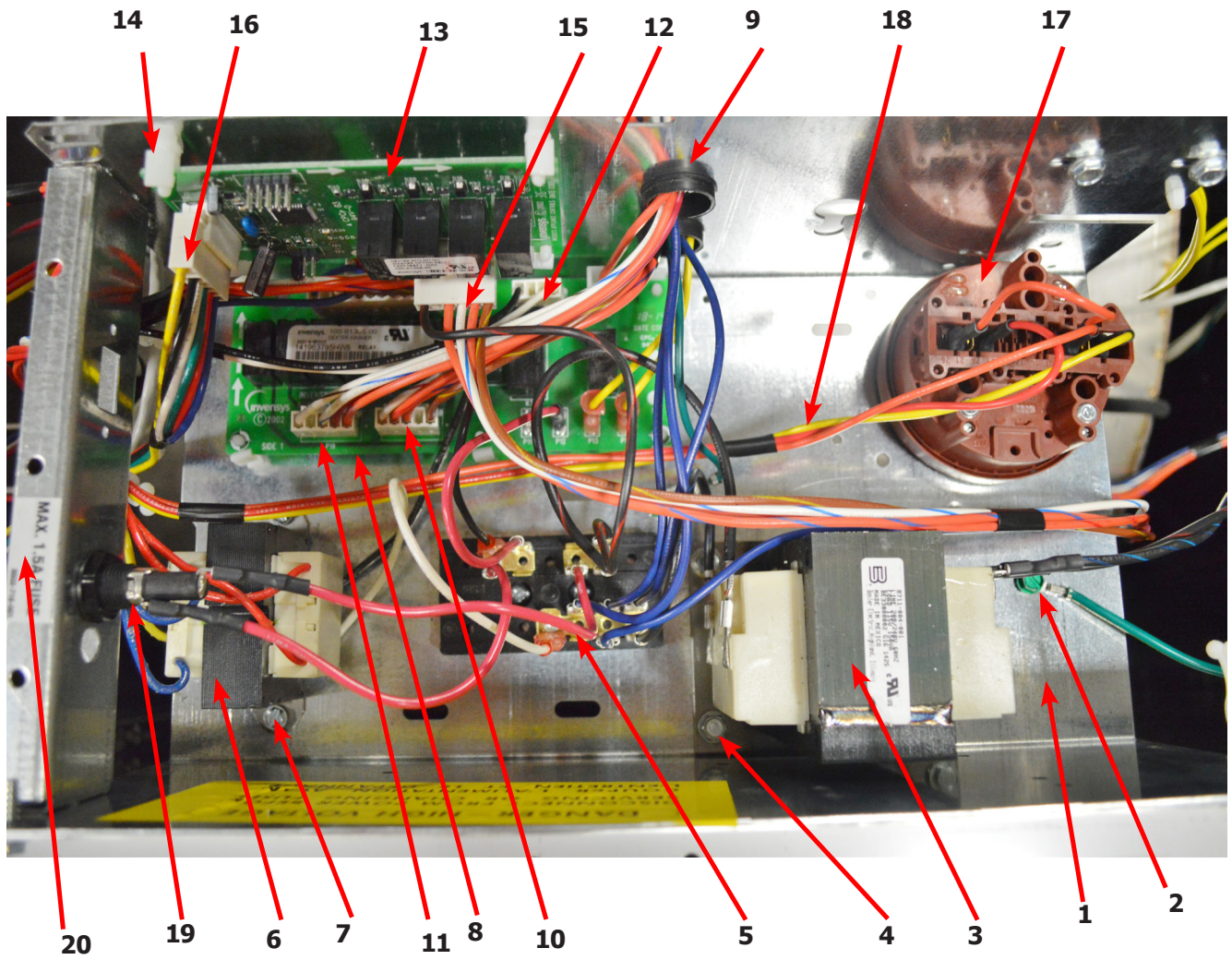

Electronic Pressure Sensor

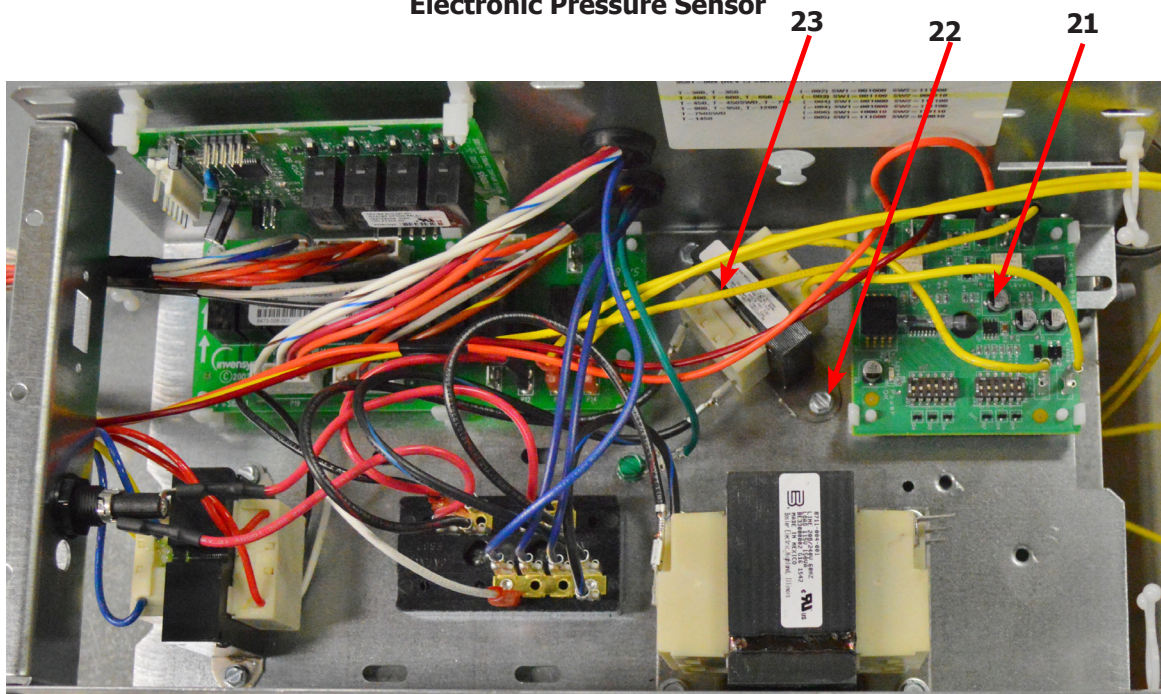

Control Panel Part # by Model

| Key | Description | T650 | T750 | T950 | T1450 | QTY |
|-----|--|--------------|--------------|--------------|--------------|-----|
| 1 | Panel Control Assembly(panel only) | 9989-479-001 | 9989-480-001 | 9989-480-001 | 9989-530-001 | 1 |
| 2 | Nameplate,Control Panel (one piece) Black | 9412-236-001 | 9412-223-001 | 9412-225-001 | 9412-230-001 | 1 |
| * | Screw-Hxwshrhnduct #10Bx 1/2"(Control Panel To side Panel) | 9545-008-026 | 9545-008-026 | 9545-008-026 | 9545-008-026 | 4 |
| 3 | Plastic Shield over main PCB | 9550-184-001 | 9550-184-001 | 9550-184-001 | 9550-184-001 | 1 |
| 4 | Nut Hexkeps #8-32 | 8640-412-005 | 8640-412-005 | 8640-412-005 | 8640-412-005 | 3 |
| 5 | Screw FillHDCR 10Bx1/2" Guide | | | 9545-008-023 | 9545-008-023 | 1 |
| 6 | Locator Panel | | | 9355-001-001 | 9355-001-001 | 1 |
| 7 | Plate -Latch, Top | | | 9452-625-001 | 9452-625-001 | 2 |
| 8 | Nut Hexkeps #8-32 | | | 8640-412-005 | 8640-412-005 | 4 |
| 9 | Spacer Pushbutton (Micro) | 9538-178-001 | 9538-178-001 | 9538-178-001 | 9538-178-001 | 1 |
| 10 | Pushbutton Control (OPL), Black | 9035-060-004 | 9035-060-004 | 9035-060-004 | 9035-060-004 | 1 |
| 11 | Retainer Pushbutton (Micro) | 9486-158-001 | 9486-158-001 | 9486-158-001 | 9486-158-001 | 1 |
| 12 | Nut Hexelasticstop #4-40 | 8640-424-002 | 8640-424-002 | 8640-424-002 | 8640-424-002 | 2 |
| 13 | Spacer Plastic #6x9/16 | 9538-157-022 | 9538-157-018 | 9538-157-018 | 9538-157-018 | 5 |
| 14 | PCB assembly Control /Display | 9473-004-009 | 9473-004-008 | 9473-004-008 | 9473-004-008 | 1 |
| 15 | Nut Elasticstop #6-32 | 8640-411-002 | 8640-411-002 | 8640-411-002 | 8640-411-002 | 4 |
| 16 | Nut Hexkeps #6-32 | 8640-411-003 | 8640-411-003 | 8640-411-003 | 8640-411-003 | 1 |
| 17 | Spacer Plastic #6x9/16 | 9538-157-018 | 9538-157-018 | 9538-157-018 | 9538-157-018 | 2 |
| 18 | PCB assembly Mode lights | 9473-005-001 | 9473-005-001 | 9473-005-001 | 9473-005-001 | 1 |
| 19 | Nut Hexkeps #6-32 | 8640-411-003 | 8640-411-003 | 8640-411-003 | 8640-411-003 | 2 |
| 20 | Harness-LED PCB, P3 | 9627-797-001 | 9627-797-001 | 9627-797-001 | 9627-797-001 | 1 |
| 21 | Spacer Plastic #6x9/16 | 9538-157-018 | 9538-157-018 | 9538-157-018 | 9538-157-018 | 2 |
| 22 | Light, LED,ADD BLEACH Asembly | 9794-001-001 | 9794-001-001 | 9794-001-001 | 9794-001-001 | 1 |
| 23 | Nut Hexkeps #6-32 | 8640-411-003 | 8640-411-003 | 8640-411-003 | 8640-411-003 | 2 |
| 24 | Lock-Run/Program, w/Harness & Key, P2 | 8650-027-001 | 8650-027-001 | 8650-027-001 | 8650-027-001 | 1 |
| * | Key (N561) | 6292-006-013 | 6292-006-013 | 6292-006-013 | 6292-006-013 | AR |
| 25 | Actuator Assy-Door Locking, 120V | 9892-015-001 | 9892-015-001 | 9892-015-001 | 9892-015-001 | 1 |
| 26 | Nut Hexkeps #8-32 | 8640-412-005 | 8640-412-005 | 8640-412-005 | 8640-412-005 | 4 |
| 27 | Nut-Spring | 8640-399-008 | 8640-399-008 | 8640-399-008 | 8640-399-008 | 2 |
| * | Screw FillHDCR 10Bx1/2" Guide | 9545-008-023 | 9545-008-023 | | | |
| 28 | Bracket-Retainer, Front Panel | | | 9029-191-001 | 9029-191-001 | 1 |
| 29 | Screw FillHDCR 10Bx1/2" Guide | | | 9545-008-023 | 9545-008-023 | 2 |
| * | Harness-Optional relay, P23-P15 | 9627-798-001 | 9627-798-001 | 9627-798-001 | 9627-798-001 | 1 |
| * | Harness-PCB to Relay, P8-P16 | 9627-794-001 | 9627-794-001 | 9627-794-001 | 9627-794-001 | 1 |
| * | Harness-Door Lock, P4 | 9627-791-004 | 9627-791-005 | 9627-791-005 | 9627-791-005 | 1 |
| * | Harness-PCB to Enable, P20-P21 | 9627-793-001 | 9627-793-001 | 9627-793-001 | 9627-793-001 | 1 |
| * | Transformer-120V/24/5.3, P7 | 8711-009-001 | 8711-009-001 | 8711-009-001 | 8711-009-001 | 1 |
| * | Harness-Pressure Switch, P5 | 9627-806-001 | 9627-807-001 | 9627-807-001 | 9627-899-001 | |

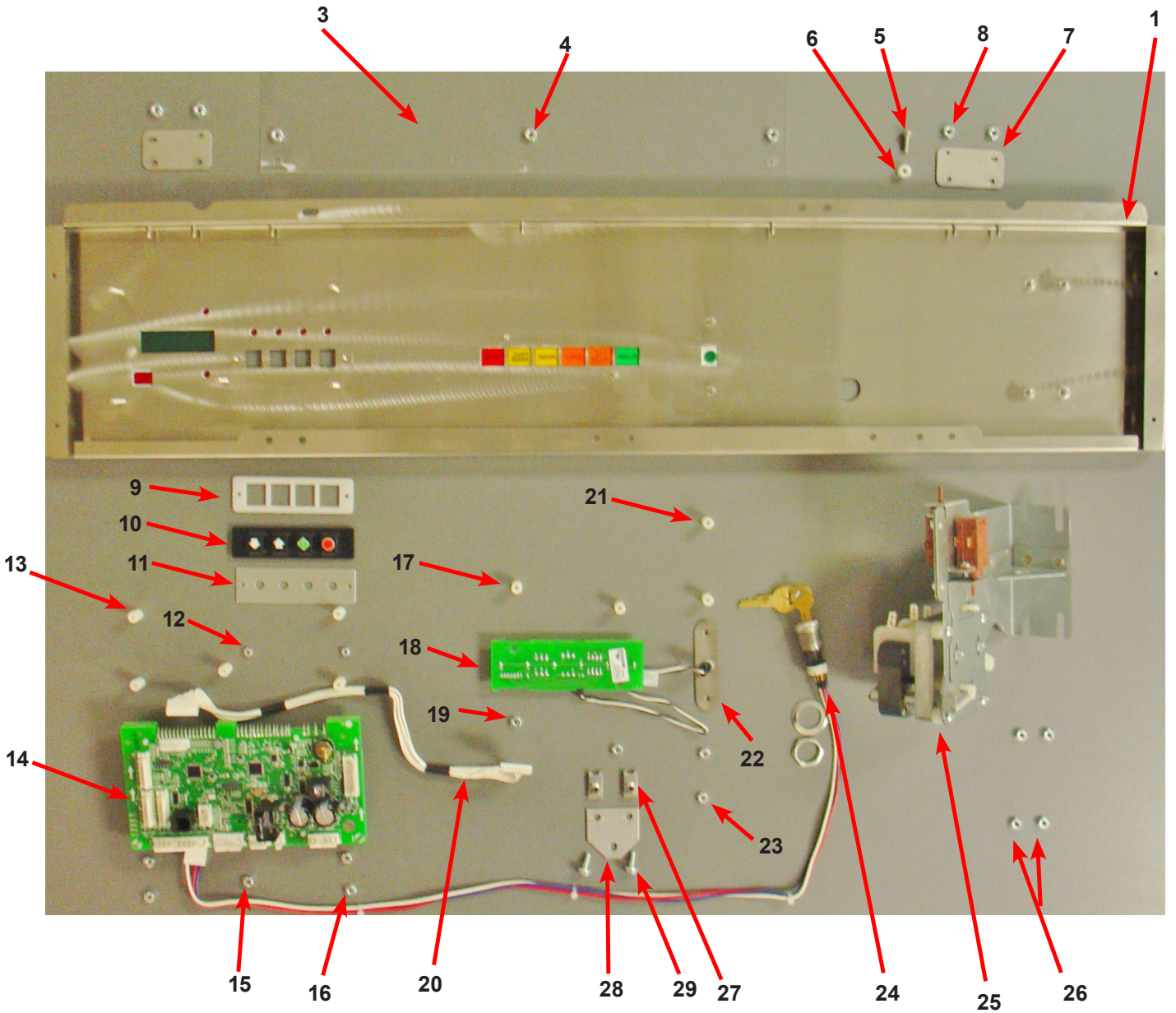

Labels and Diagrams All C-Series Models

| Key | Description | T650 | T750 | T950 | T1450 | QTY |
|-----|---|--------------|--------------|--------------|--------------|-----|
| * | Operators Manual | 8514-257-001 | 8514-242-001 | 8514-243-001 | 8514-247-001 | 1 |
| | Wiring Schematic & Diagram | 9506-708-001 | 9506-556-001 | 9506-560 | 9506-564-001 | 1 |
| * | Transient Voltage Surge Suppressor Infomational | 8507-330-001 | 8507-330-001 | 8507-330-001 | 8507-330-001 | 1 |
| * | Instructions Spin Direction | 8507-275-001 | 8507-275-001 | 8507-275-001 | 8507-275-001 | 1 |
| * | Label High Voltage Warning | 8502-614-004 | 8502-614-004 | 8502-614-004 | 8502-614-004 | 1 |
| * | Label Fusing & Installation | 8502-619-004 | 8502-619-003 | 8502-619-003 | 8502-619-003 | 1 |
| * | Label Quality | 8511-001-002 | 8511-001-002 | 8511-001-002 | 8511-001-002 | 1 |
| 1 | Label Warning Risk of Injury (Black) | 8502-759-001 | 8502-759-001 | 8502-759-001 | 8502-759-001 | 1 |
| 2 | Label Warning Door Opening (Black) | 8502-757-001 | 8502-757-001 | 8502-757-001 | 8502-757-001 | 1 |
| 3 | Label Dispenser (Black) | 8502-745-001 | 8502-745-001 | 8502-745-001 | 8502-745-001 | 1 |
| | Label, Injector Assembly | 8502-666-001 | 8502-666-001 | 8502-666-001 | 8502-666-001 | 1 |



Risk of Injury Label



Door Label



Top Dispenser Label Front Soap Dish



Section :9

Parts 50Hz

Models:

Parts in this section used only in these models. All other parts are same as standard 60 Hz pages.

Wiring Diagrams & Schematics

| | | | |
|---------------|---------------|-------|-----------------------------|
| WN0750XA-39XV | 208-240 volts | 60hz. | Single Phase or Three Phase |
| WN0950XA-39XV | 208-240 volts | 60hz | Single Phase or Three Phase |
| WN1450XA-39XV | 208-240 volts | 60 hz | Single Phase or Three Phase |

Transformer, Electrical Filter -39 models

| | | | |
|--------------|-----------|-------|--------------|
| Wn0750-XA39 | 230 volts | 50hz | Single Phase |
| Wn0900-XA39 | 230 volts | 50hz. | Single Phase |
| WN0950-XA39 | 230 volts | 50hz. | Single Phase |
| WN01200-XA39 | 230 volts | 50hz | Single Phase |
| WN01450-XA39 | 230 volts | 50hz | Single Phase |

| Key | Component | T650 | T750 | T950 | T1450 | QTY |
|-----|---|--------------|--------------|--------------|--------------|-----|
| 1 | Circuit Breaker | 5198-211-002 | 5198-211-002 | 5198-211-002 | 5198-211-002 | 1 |
| * | Instructions, Transformer Connect | 8507-449-002 | 8507-449-002 | 8507-449-002 | 8507-449-002 | 1 |
| * | Manual-Opeators | 8514-228-002 | 8514- | | | 1 |
| 2 | Controls Transformer, 200/250-24V 50Hz. | 8711-004-003 | 8711-004-003 | 8711-004-003 | 8711-004-003 | 1 |
| | Water Valve | 9379-183-011 | 9379-183-011 | 9379-183-011 | 9379-183-011 | 2 |
| | Diaphragm Invensys (EPDM) | 9118-049-001 | 9118-049-001 | 9118-049-001 | 9118-049-001 | 2 |
| | Diaphragm Invensys (Viton) | 9118-049-002 | 9118-049-002 | 9118-049-002 | 9118-049-002 | 2 |
| | Water Valve Single | | | 9379-194-003 | 9379-194-003 | 2 |
| | Diaphragm Mueller | | | 9118-055-001 | 9118-055-001 | 1 |
| | Wiring Label , Schematic & Diagram | 9506-534-001 | 9506-536-001 | 9506-538-001 | 9506-541-001 | 1 |
| | Wiring Harness, Power Terminal Block | 9627-747-006 | 9627-747-006 | 9627-747-006 | 9627-747-006 | 1 |
| | Wiring Harness Main, 1.5 | 9627-914-001 | 9627-914-001 | 9627-914-001 | 9627-914-001 | 1 |
| | Hose Assembly, Inlet | 9990-027-014 | | | | |

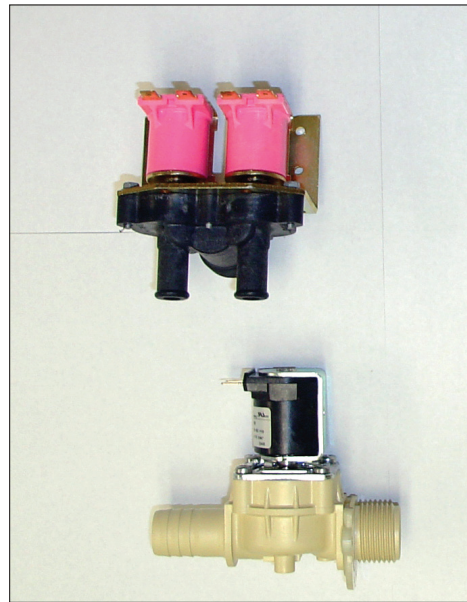
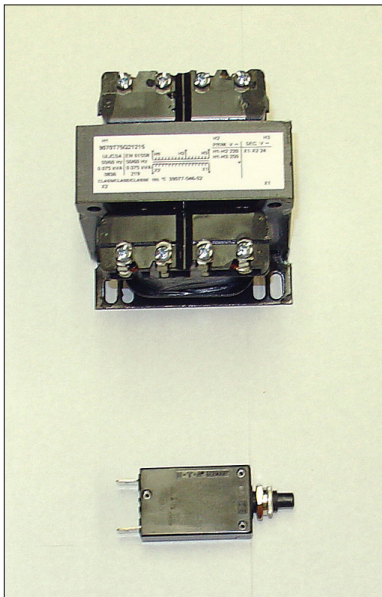

Drain Valve Group Part 50 HZ

| Key | Description | Part Number | Qty |
|-----|---|--------------|-----|
| 1 | Valve, Drain (includes #2 thru #11) | 9379-202-002 | 1 |
| 2 | Body, Valve (w/ball) | 9064-072-001 | 1 |
| 3 | Motor & Gear Train (complete) | 9914-137-022 | 1 |
| 4 | Plate, Motor Mtg | 9452-538-001 | 1 |
| 5 | Screw | 8639-994-001 | 1 |
| 6 | Spring, Drive | 9534-339-001 | 1 |
| 7 | Screw | 9545-054-001 | 1 |
| 8 | Screw | 9545-054-002 | 1 |
| 9 | Seal, V Packer | 9532-134-001 | 1 |
| 10 | Washer | 8641-584-001 | 1 |
| 11 | Pin, Main Drive | 9451-196-001 | 1 |
| * | Plate (spacers needed for replacement motor mtg. plate) | 9538-149-001 | 1 |
| 12 | Kit - Seal Replacement | 9732-327-001 | 1 |

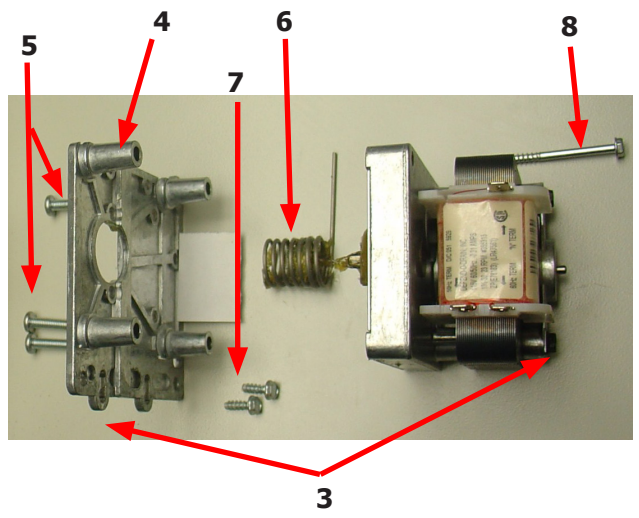
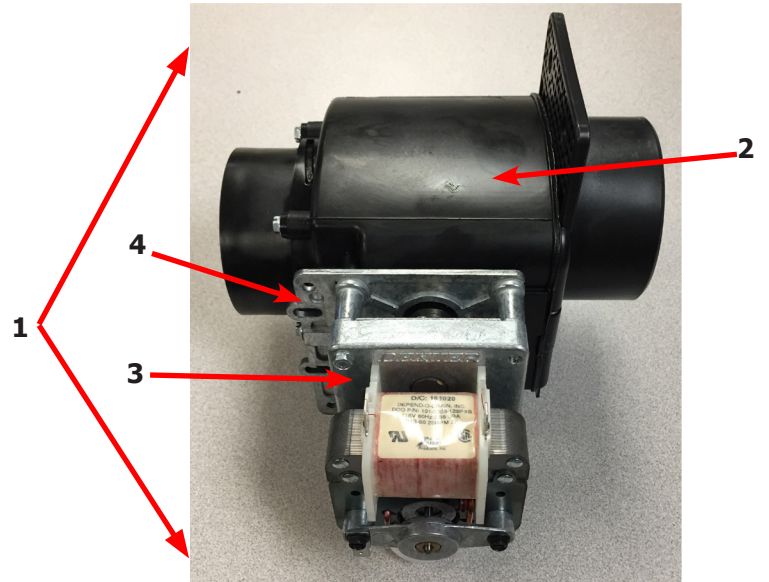
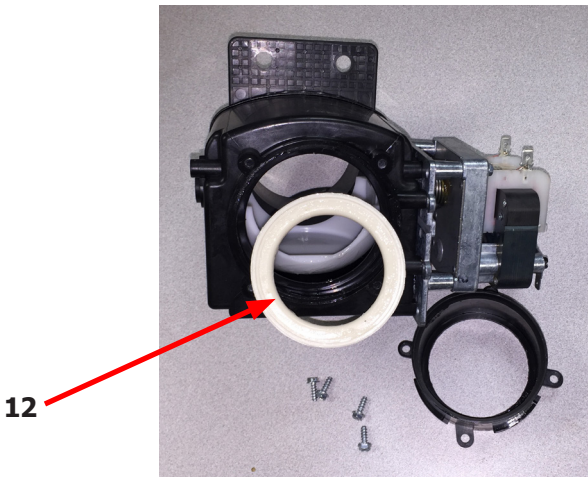

Gear Motor Door Lock Assembly 24V AC

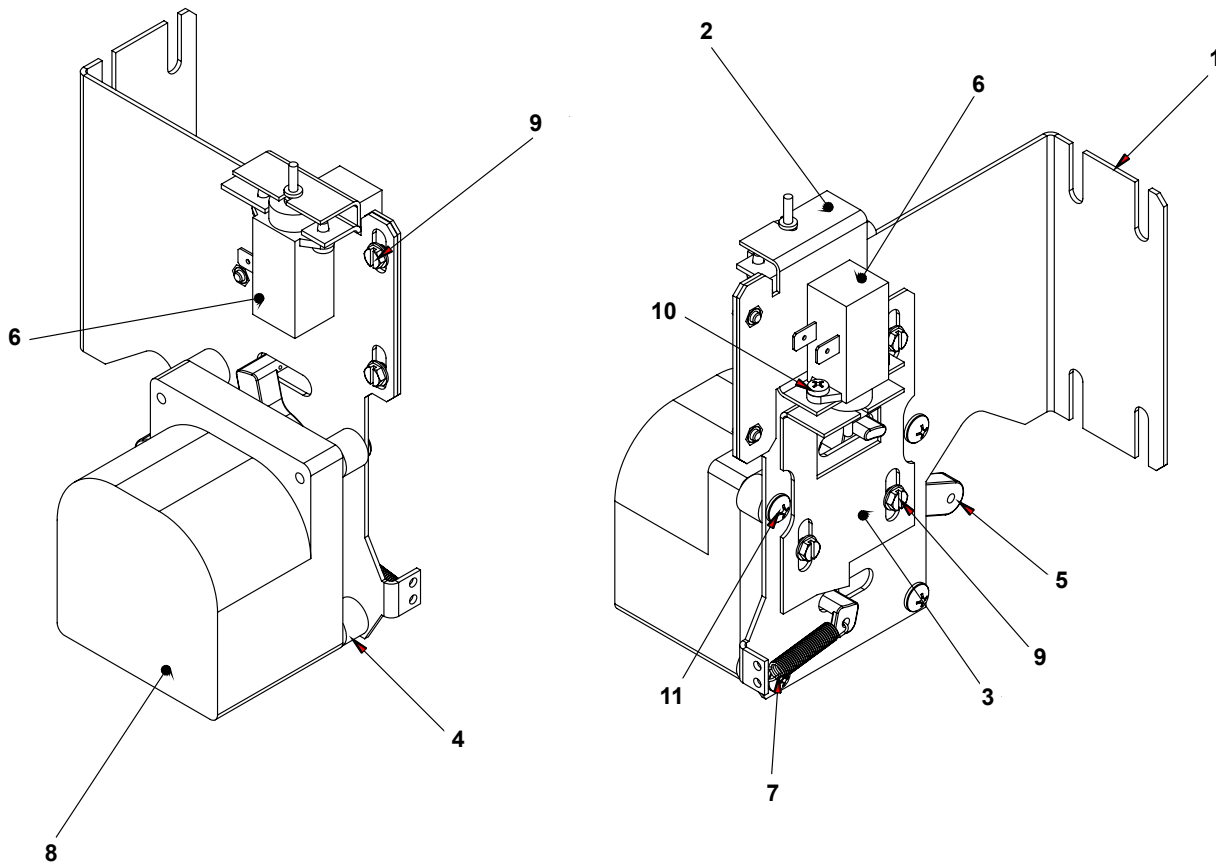

| Key | Description | T650 | T750 | T950 | T1450 | QTY |
|-----|---|--------------|--------------|--------------|--------------|-----|
| * | Actuator Assembly (Includes 1-10, Rod NOT included) | 9892-015-002 | 9892-015-002 | 9892-015-002 | 9892-015-002 | 1 |
| 1 | Bracket Assy, Slide Lock Actuator | 9985-190-001 | 9985-190-001 | 9985-190-001 | 9985-190-001 | 1 |
| 2 | Bracket Assy, Slide - Unlock | 9985-189-001 | 9985-189-001 | 9985-189-001 | 9985-189-001 | 1 |
| 3 | Bracket Slide Lock | 9029-204-001 | 9029-204-001 | 9029-204-001 | 9029-204-001 | 1 |
| 4 | Spacer, Plastic | 9538-157-021 | 9538-157-021 | 9538-157-021 | 9538-157-021 | 4 |
| 5 | Arm - Door Lock | 9001-063-001 | 9001-063-001 | 9001-063-001 | 9001-063-001 | 1 |
| 6 | Thermoactuator - Door Lock Relay 24VAC | 9586-001-003 | 9586-001-003 | 9586-001-003 | 9586-001-003 | 2 |
| 7 | Spring - Extension | 9534-350-001 | 9534-350-001 | 9534-350-001 | 9534-350-001 | 1 |
| 8 | Motor & Gear Assembly 24VAC | 9914-137-014 | 9914-137-014 | 9914-137-009 | 9914-137-009 | 1 |
| 9 | Screw -Hxwshrdslsems, 6-32 x 3/16 | 9545-044-003 | 9545-044-003 | 9545-044-003 | 9545-044-003 | 6 |
| 10 | Cross Recessed PAn Hd Tapping screw | 9545-031-011 | 9545-031-011 | 9545-031-011 | 9545-031-011 | 4 |
| 11 | Screw Pnhdcr, 10-32 UNFx0 .75 | 9545-012-029 | 9545-012-029 | 9545-012-029 | 9545-012-029 | 4 |
| * | Rod, Door Lock | | 9497-225-013 | 9497-225-015 | 9497-225-016 | 1 |

T650 230/50/1 Voltage Schematic

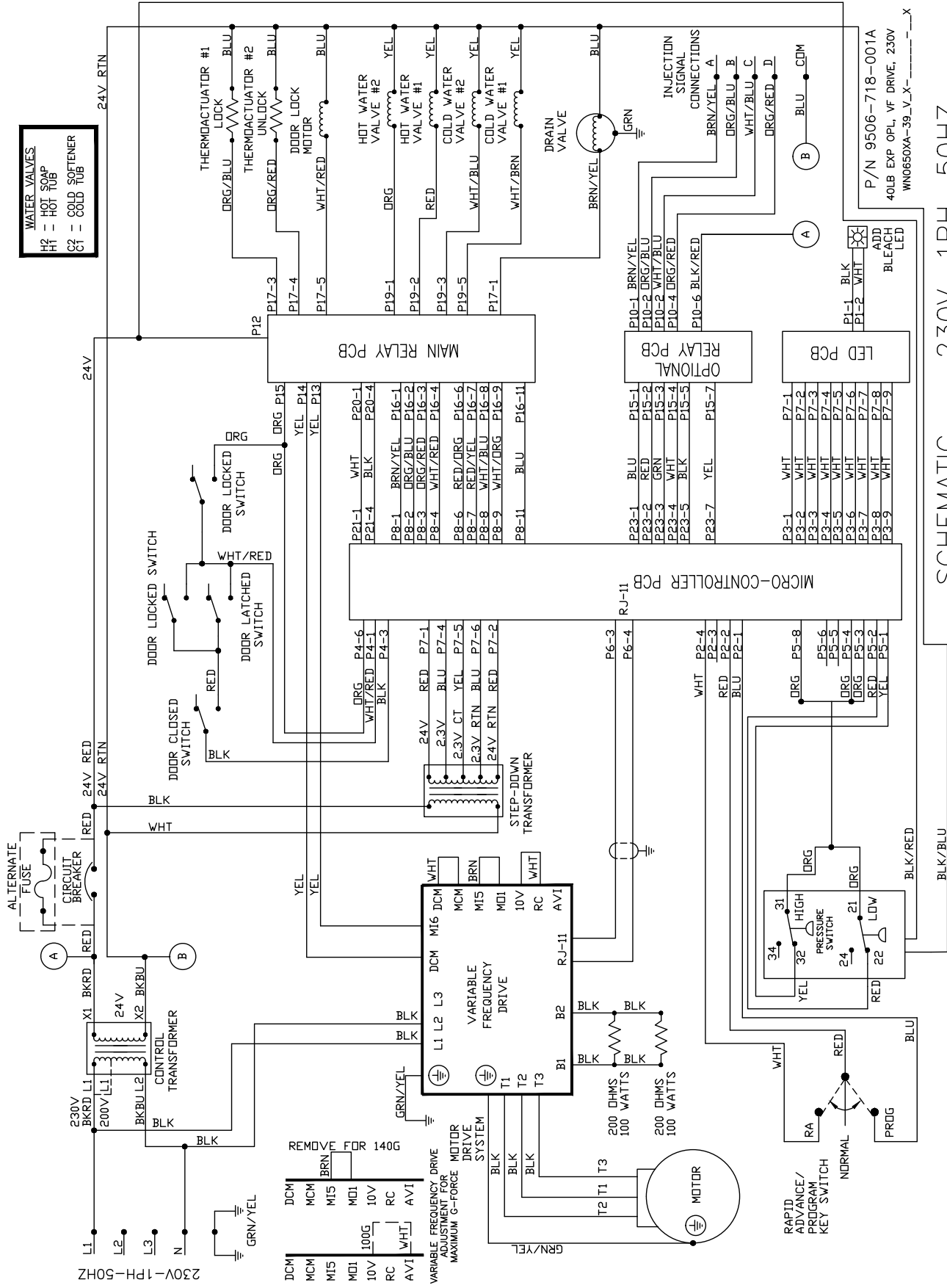

SCHEMATIC 230V, 1PH, 50HZ

T650 230/50/1 Voltage Diagram 230/50/1 Voltage Diagram

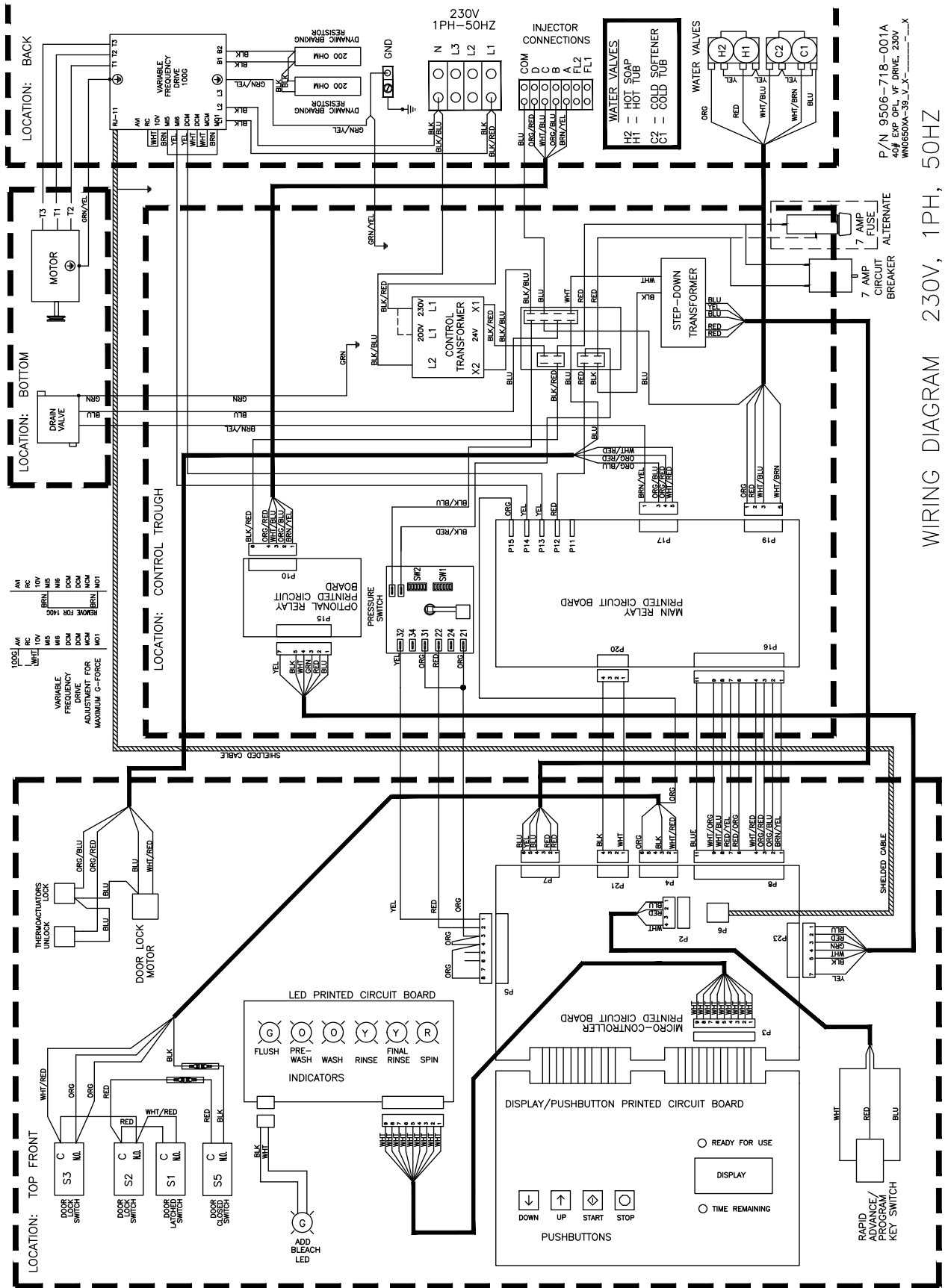

P/N 9506-718-001A
40# EXP. OPT. V.F. DRIVE, 230V
W16650A-3S1_1_x

T750 230/50/1 Voltage Schematic

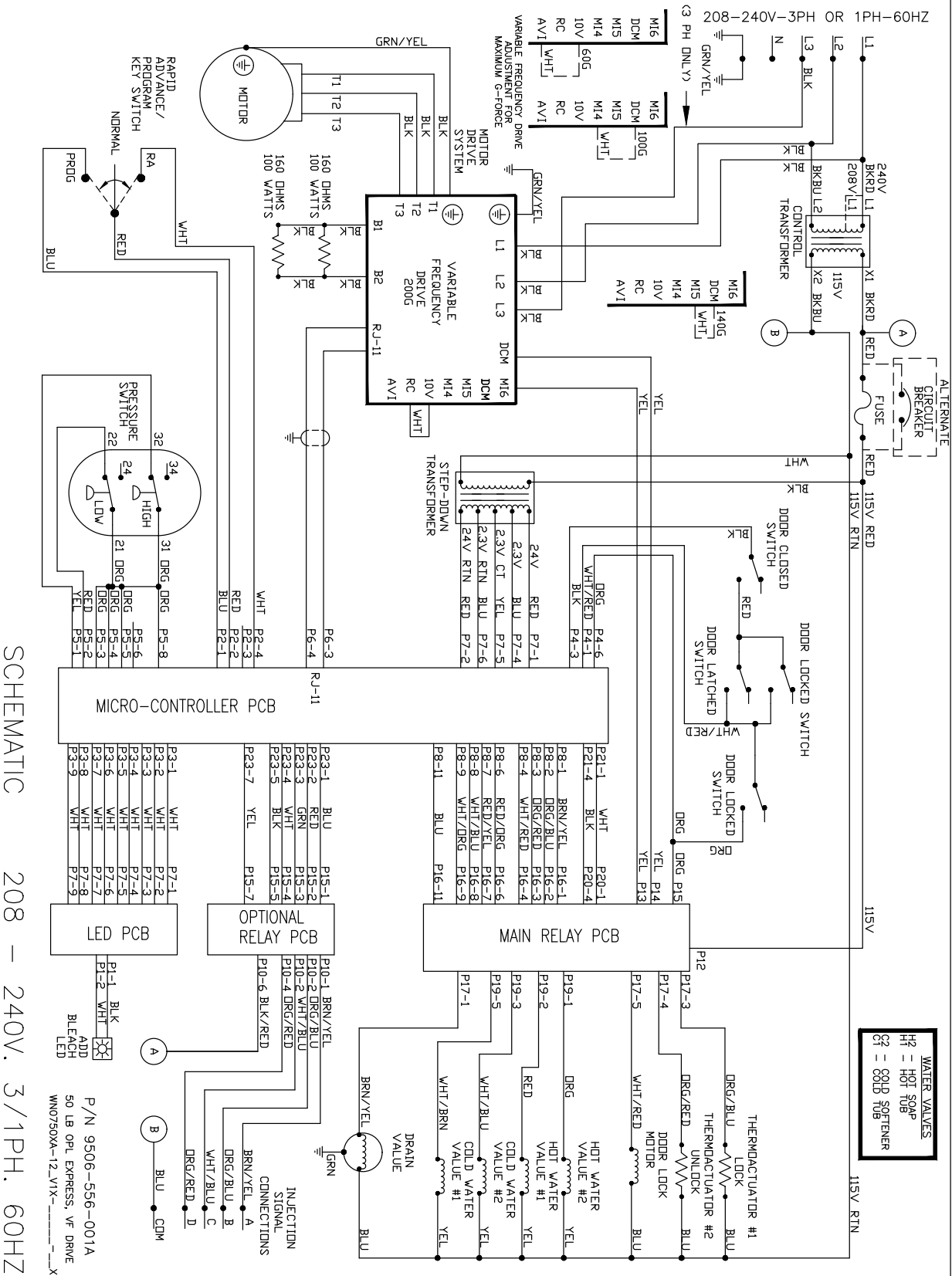

T750 230/50/1 Voltage Diagram 230/50/1 Voltage Diagram

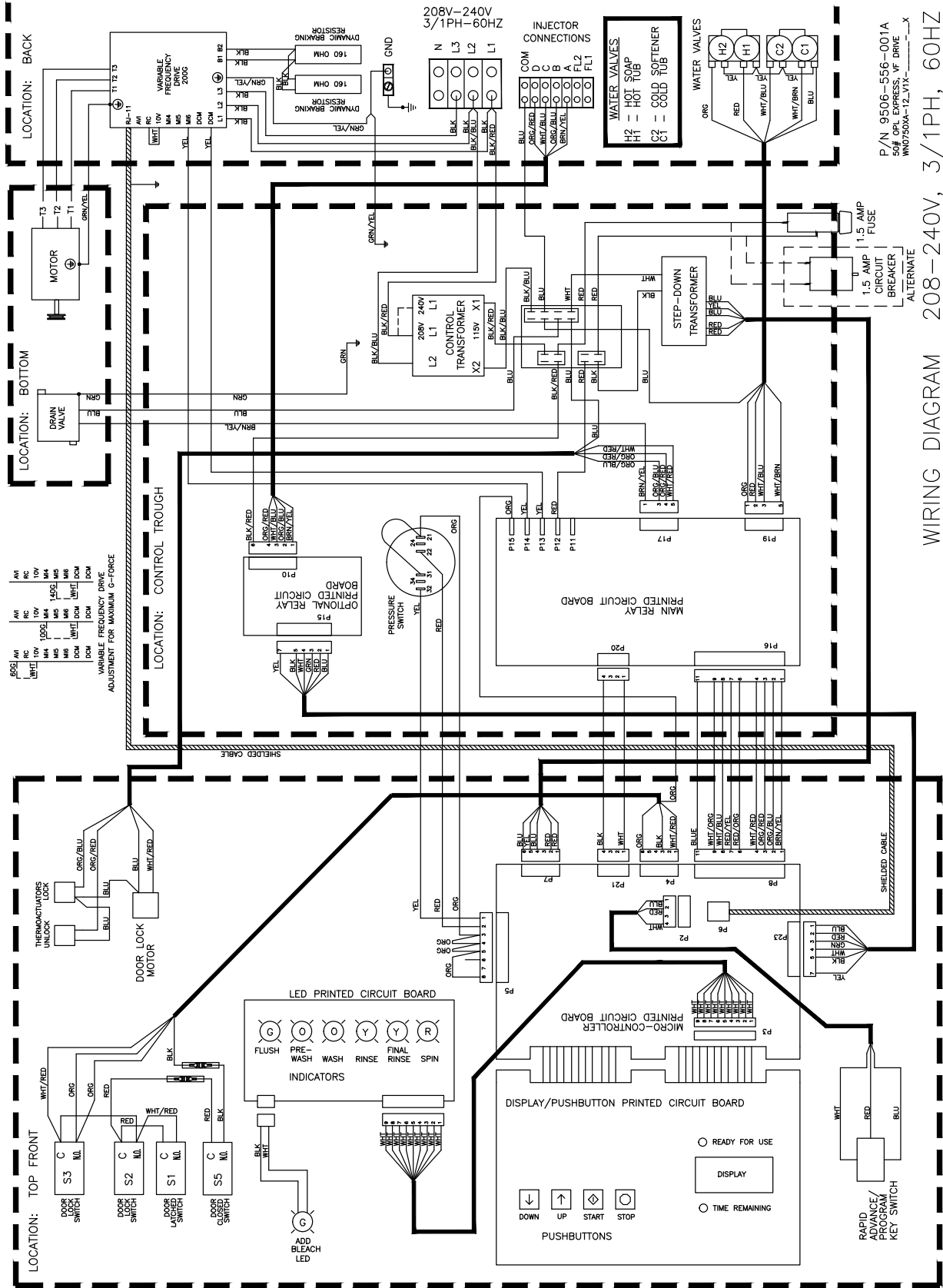

T950 230/50/1 Voltage Schematic

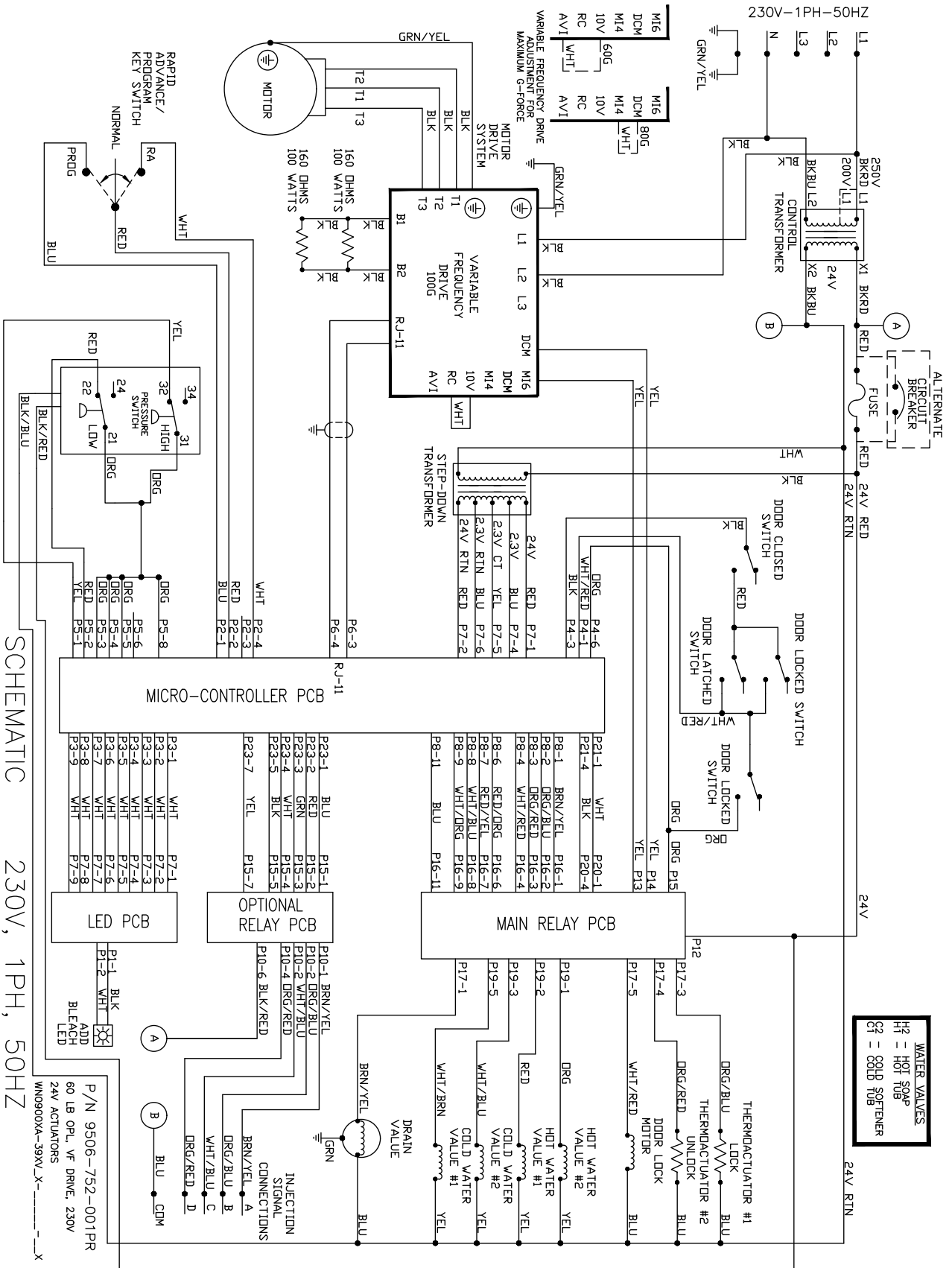

SCHEMATIC 230V, 1PH, 50HZ

T950 230/50/1 Voltage Diagram

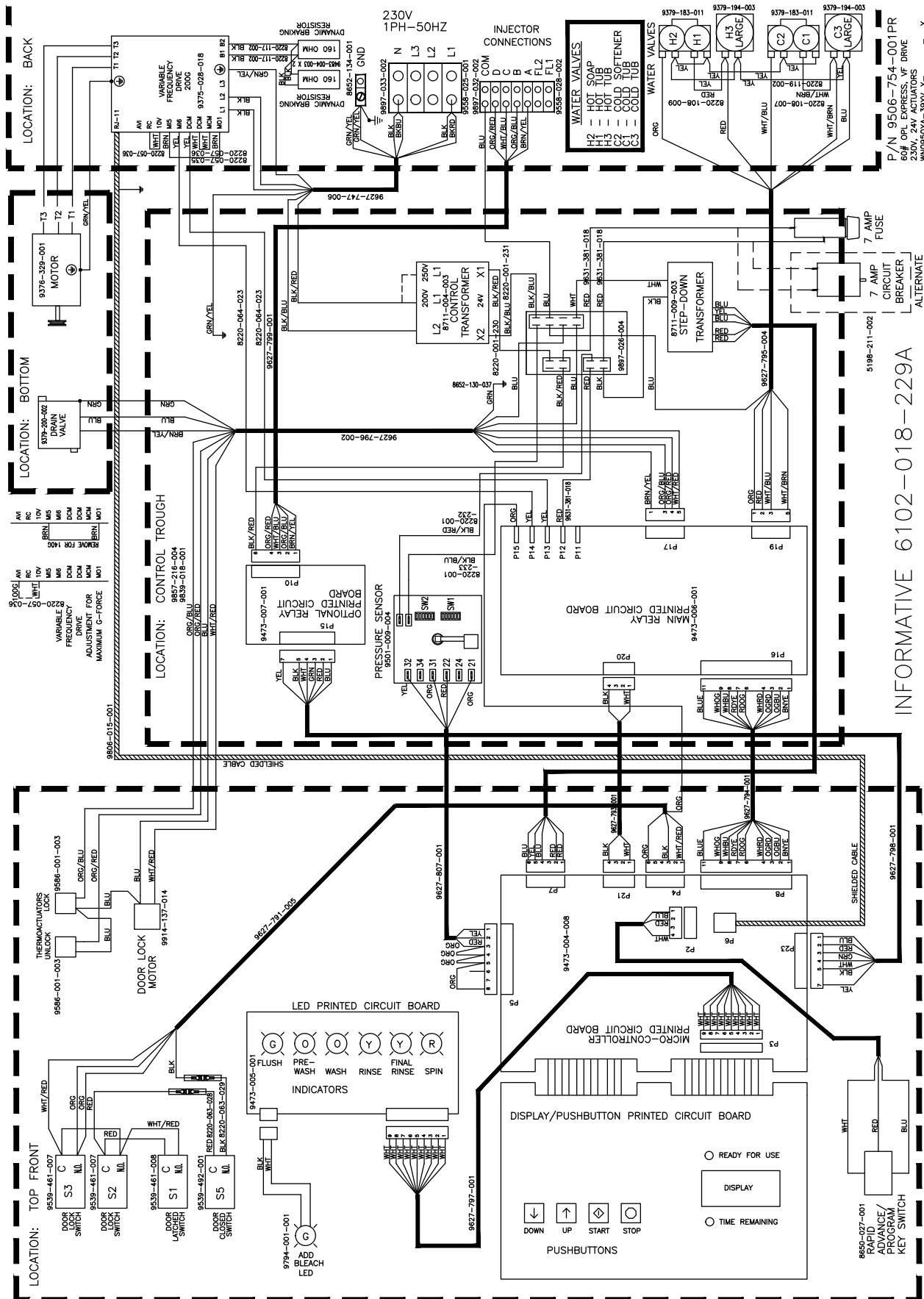

INFORMATIVE 6102-018-229A
WIRING DIAGRAM 230V, 1PH, 50HZ

P/N 9506-754-001PR
ON EXCESSIVE DRIVE
230V 50/60 HZ
WING50VA-39V_X-X

T1450 230/50/1 Voltage Schematic

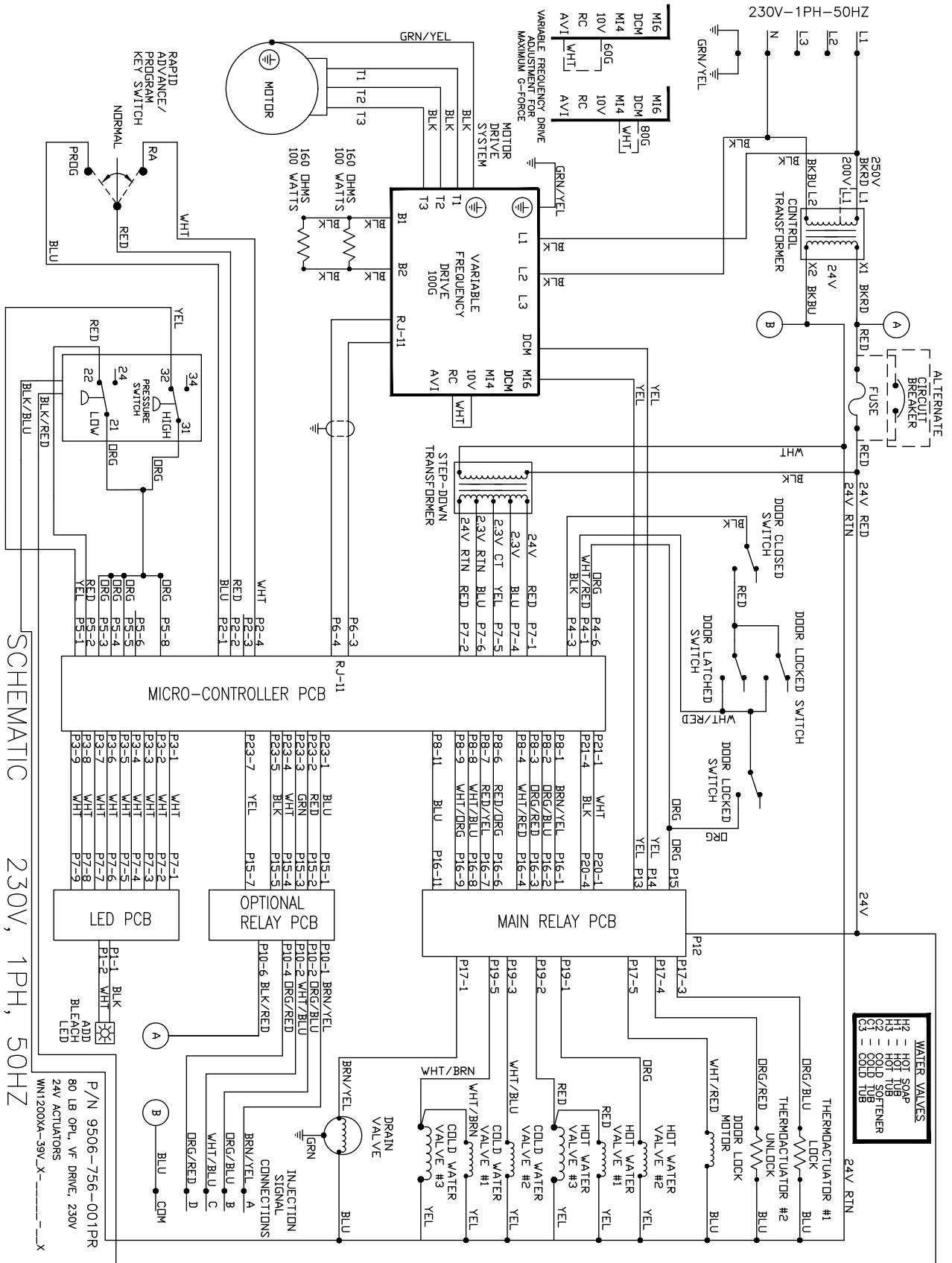

Section :10

Maintenance

Preventative Maintenance

Daily

- Step 1:** Clean the top and the cabinet to remove residue.
- Step 2:** Clean the soap dispenser and soap lid
- Step 3:** Check the drain for leaking and proper draining.
- Step 4:** Check the loading door for leaks.
- Step 5:** Clean the door seal of all foreign material.
- Step 6:** Leave the loading door open to aerate the washer when not in use.

Monthly

- Step 1:** Clean with dry and clean compressed air through optical coin acceptor to remove dust and lint.

Quarterly

Make sure the power is disconnected before making the following checks.

- Step 1:** Check the drive belt for wear and proper tension.
- Step 2:** Clean lint and other foreign material from around drive motor.
- Step 3:** Check all water connections for leaks.
- Step 4:** Wipe and clean the inside of the washer and check all electrical components for moisture and dust.
- Step 5:** Remove and clean water inlet hose filters. Replace if necessary.
- Step 6:** After any service always replace all panels before reconnecting electrical power.

Biannually

- Step 1:** Clean the fan on the bottom of the VFD with dry and clean compressed air.

Annually

- Step 1:** Inspect all wire connections for tightness
- Step 2:** Inspect and check the tightness of the mounting bolts securing the washer to base frame.

