









DEXTER[®]
LAUNDRY



C-Series OPL Washers
WN0900, WN1200 (100G)

Equipment Safety Warnings

Symbols and Terminology Used in this Equipment

 DANGER	Indicates an imminently hazardous situation, which if not avoided, will result in death or serious injury.
 WARNING	Indicates a potentially hazardous situation, which if not avoided could result in death or serious injury.
 CAUTION	Indicates a potentially hazardous situation which, if not avoided, may result in minor or moderate injury. It may also be used to alert against unsafe practices. Minor burns, pinch points that result in bruises and minor chemical irritation.
NOTICE	Indicates information or a company policy that relates directly or indirectly to the safety of personnel or protection of property.
	This is the user caution symbol. It indicates a condition where damage to the equipment resulting in injury to the operator could occur if operational procedures are not followed. TO REDUCE THE RISK OF DAMAGE OR INJURY, refer to accompanying documents; follow all steps or procedures as instructed.
	This is the electrical hazard symbol. It indicates that there are DANGEROUS HIGH VOLTAGES PRESENT inside the enclosure of this product. TO REDUCE THE RISK OF FIRE OR ELECTRIC SHOCK, do not attempt to open the enclosure or gain access to areas where you are not instructed to do so. REFER SERVICING TO QUALIFIED SERVICE PERSONEL ONLY
	Caution! There are sharp edges on various sheet metal parts internal to the enclosure. Use safety consciousness when placing or moving your hands while working in the interior of this equipment.
	Caution! To reduce the risk of damage to the Water Inlet Valve, do not supply inlet water with a temperature that exceeds 70° C. Caution! To reduce the risk of fire or explosion, do not operate this equipment in any hazardous classified (ATEX) environment.

Equipment Safety Warnings

Symbols and Terminology Used in this Equipment



Warning! Do not operate equipment if door glass is damaged in any way.



Warning! Keep clear of rotating parts.



Prohibited! Do not enter this equipment or space.



Prohibited! Do not step or stand on this equipment.



Prohibited! Do not operate without all guards and covers in place.









Prohibited! Do not operate without all guards and covers in place.



Prohibited! Do not wash clothing impregnated with flammable liquids (petrochemical).







Prohibited! Do not allow children to play in or around equipment.

	<p>Indicates an imminently hazardous situation, which if not avoided, <u>will result</u> in death or serious injury.</p>
	<p>Indicates a potentially hazardous situation, which if not avoided <u>could result</u> in death or serious injury.</p>
	<p>Indicates a potentially hazardous situation which, if not avoided, <u>may result</u> in minor or moderate injury. It may also be used to alert against unsafe practices. Minor burns, pinch points that result in bruises and minor chemical irritation.</p>
<p>NOTICE</p>	<p>Indicates information or a company policy that relates directly or indirectly to the safety of personnel or protection of property.</p>
	<p>This is the user caution symbol. It indicates a condition where damage to the equipment resulting in injury to the operator could occur if operational procedures are not followed. TO REDUCE THE RISK OF DAMAGE OR INJURY, refer to accompanying documents; follow all steps or procedures as instructed.</p>
	<p>This is the electrical hazard symbol. It indicates that there are DANGEROUS HIGH VOLTAGES PRESENT inside the enclosure of this product. TO REDUCE THE RISK OF FIRE OR ELECTRIC SHOCK, do not attempt to open the enclosure or gain access to areas where you are not instructed to do so. REFER SERVICING TO QUALIFIED SERVICE PERSONEL ONLY</p>
	<p>Caution! To reduce the risk of fire or explosion, do not operate this equipment in any hazardous classified (ATEX) environment.</p>



WARNING

	<ul style="list-style-type: none">• All washers must be installed in accordance to all applicable electrical, plumbing and all other local codes.• These installation and operation instructions are for use by qualified personnel only. To avoid injury and electrical shock, do not perform any servicing other than that contained in the installation and operation instructions, unless qualified.
	<p>Do not install washers in an explosive atmosphere.</p>
	<ul style="list-style-type: none">• Care must be stressed with all foundation work to ensure a stable unit installation, eliminating possibilities of excessive vibration.• Foundation must be level within 13 mm to ensure proper washer operation.
	<p>Do not operate washer if door glass is damaged in any way.</p>
	<p>Do not wash clothing impregnated with flammable liquids (petrochemical).</p>



WARNING







	<p>Children should be supervised to ensure they do not operate or play in or around equipment.</p>
	<p>Keep all panels in place to protect against electrical shock and injury and add rigidity to washer.</p>

This appliance is not intended for use by persons (including children) with reduced physical, sensory or mental capabilities, or lack of experience and knowledge, unless they have been given supervision or instruction concerning use of the appliance by a person responsible for their safety.

A washer should not be allowed to operate if any of the following occur:

- **Excessive high water level.**
- **Machine is not connected to a properly earthed circuit.**
- **Door does not remain securely locked during the entire cycle.**
- **Vibration or shaking from an inadequate mounting or foundation**

	<p>Warning! Do not operate equipment if door glass is damaged in any way.</p>
	<p>Warning! Keep clear of rotating parts.</p>
	<p>Prohibited! Do not enter this equipment or space.</p>
	<p>Prohibited! Do not step or stand on this equipment.</p>
	<p>Prohibited! Do not operate without all guards and covers in place.</p>
	<p>Prohibited! Do not operate without all guards and covers in place.</p>
	<p>Prohibited! Do not wash clothing impregnated with flammable liquids (petrochemical).</p>
	<p>Prohibited! Do not allow children to play in or around equipment.</p>

	<p>Prohibited! Do not attempt to open, touch, or proceed before referring to the manual or unless qualified.</p>
	<p>Mandatory! Read all supporting documentation before operating or maintaining equipment.</p>
	<p>Mandatory! Disconnect power before servicing equipment.</p>
	<p>Mandatory! Lock out and tag out before servicing this equipment.</p>
	<p>Mandatory! Disconnect water supply before servicing equipment.</p>
	<p>Mandatory! Children should be supervised to ensure they do not operate equipment.</p>

Dexter Safety Guidelines



WARNING

These washers are equipped with devices and features relating to their safe operation. To avoid injury or electrical shock, do not perform and service, unless qualified to do so.

FOR SAFETY

1. Always shut off power and water supply and also discharge capacitors before servicing.
2. Do not overload the washer.
3. Do not attempt to open door if cylinder is in motion or contains water.
4. Do not mechanically force or override door lock in any way.
5. Do not bypass any safety devices of this washer.
6. Do not use volatile or flammable substances in or near this washer.
7. Keep all panels in place. They protect against shock and injury and add rigidity to the washer.

A machine should not be allowed to operated if any of the following occur:

- Excessively high water level.
- Machine is not connected to a properly grounded circuit.
- Loading door does not remain securely locked during the entire cycle.
- Vibration or shaking from an inadequate mounting or foundation.

To activate your warranty, be sure to return your red warranty form to the factory. Please have serial number and model ready when calling for assistance.

Table of Contents

Section 1: Machine Mounting & Installation

T-900	14
T-1200.....	14
T-900 Installation.....	15
T-1200 Installation.....	16

Section 2: Machine Installation & Operating Instructions

Basic Installation.....	18
Electrical Connections & Fusing Requirements .	19
Machine Chemical Connection	20
Detergent Measurements by Model.....	22

Section 3: Machine Programming Instructions

Programming Presets.....	32-26
Wash Cycle	
Programming.....	27
Rapid Advance Mode.....	28

Section 4: Trouble Shooting

Common Troubleshooting Solutions Pages..	30-32
Troubleshooting Machine Fault	
Errors Pages.....	33-37
Motor Resistance Chart.....	37
Variable Frequency Drive Control	
Digital Readout Faults	38-39

Section 5: Machine Service Procedures

Lower Service Panel Removal	42
Top Panel Removal.....	42
Front Panel Removal	42
Back Panel Removal.....	42
Drain Valve Access.....	42
Drain Valve Cleaning	42
Detergent Dispenser	42
Vacuum Breaker/	

Air Gap.....	43
Water Valves	43
Door Lock Assembly Operation.....	43
Adjustment for the Door Lock Assembly	43 & 45
Adjusting the Loading Door	45
Loading Door Removal	45
Loading Door Hinge Removal.....	45
Loading Door Disassembly	46
Loading Door Reassembly	46
Control Panel Name Plate Decal.....	46
Name Plate Removal	46
Re-Installation of Name Plate.....	46
Outer Cabinet Removal	47
Door Locking Motor	47
Thermoactuators	47
Lock Thermoactuator	47
Unlock Thermoactuator.....	47
Drive Belt Removal.....	47
Tub Back, Bearing and Cylinder Assembly	48
Basket Pulley, Bearing Housing, Water Seals & Tub Back.....	48-50
T-900, T-1200 Bolt Torque Chart	51
Section 6:	
Control Mounting Trough.....	54
Main Data Communication Cable.....	54
Circuit Breaker/Fuse	54
Main Control Printed Circuit Board.....	54
PCB Transformer Step Down.....	54
Controls Transformer.....	54
Main Relay Printed Circuit Board	54
Pressure Switch	55-57
Power Connection Terminal Block	58
LED Printed Circuit Board Temperature & Start/ Display Push Button.....	58
Delta Variable Frequency Drive	58
Delta VFD Motor Leads.....	58
Delta VFD Dynamic Braking Resistors	58

Delta VFD Cooling Fan	58
-----------------------------	----

Section 7:

Machine Electrical & Wiring Schematics Start Circuit	62
Fill Circuit	62
Wash Circuit	63
Drain, Rinse 1 & 2 & Final Rinse Circuit	63
Extract Circuit.....	63
Thermoactuator and Shake Out Circuit.....	63
End of Cycle Circuit	63
Diagrams & Schematics.....	66- 70

Section 8: Parts Data

A-Series Accessories.....	72
Wiring Harness Part # by Model.....	73
Cabinet and Front Panel Group Part # by Model	74 - 75
Soap Dish.....	76 - 77
Rear View Access Part # by Model.....	78 - 79
Rear Chanel.....	80 - 81
Cylinder, Seals & Bearings Part # by Model	82 - 83
Door Lock Part # by Model	84 - 85
Loading Door Part # by Model	86 - 87
Water Inlet Part # by Model.....	88 - 89
Water Inlet Valve Breakdown I.....	90 - 91
Drain Valve Group Part # by Model.....	92
Chassis and Drain Part # by Model	94 - 95
Electrical Components - Top Compartment	96 - 97
Control Panel Part # by Model.....	98 - 99
Labels and Diagrams All WCAD Models	100

Section 9:

50 Hz Models

-39 Parts.....	103 - 106
50HZ Diagrams & Schematics.....	108 - 111

Section 10:
Maintenance

Preventative Maintenance113

Section 1:

Machine Mounting

Specifications for below models are outlined in this book:

T-900	WN0900XA-12EV	208-240 volts 60hz	Single Phase or Three Phase
T-1200	WN1200XA-12EV	208-240-volts 60hz	Single Phase or Three Phase

T900 Machine Dimensions

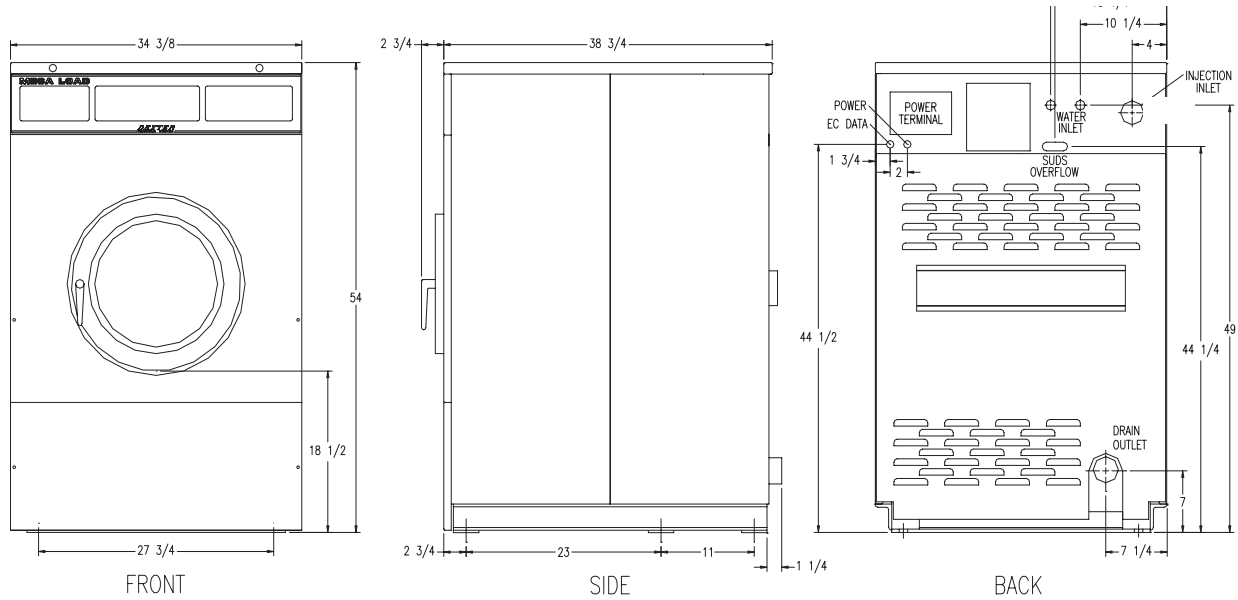

T1200 Machine Dimensions

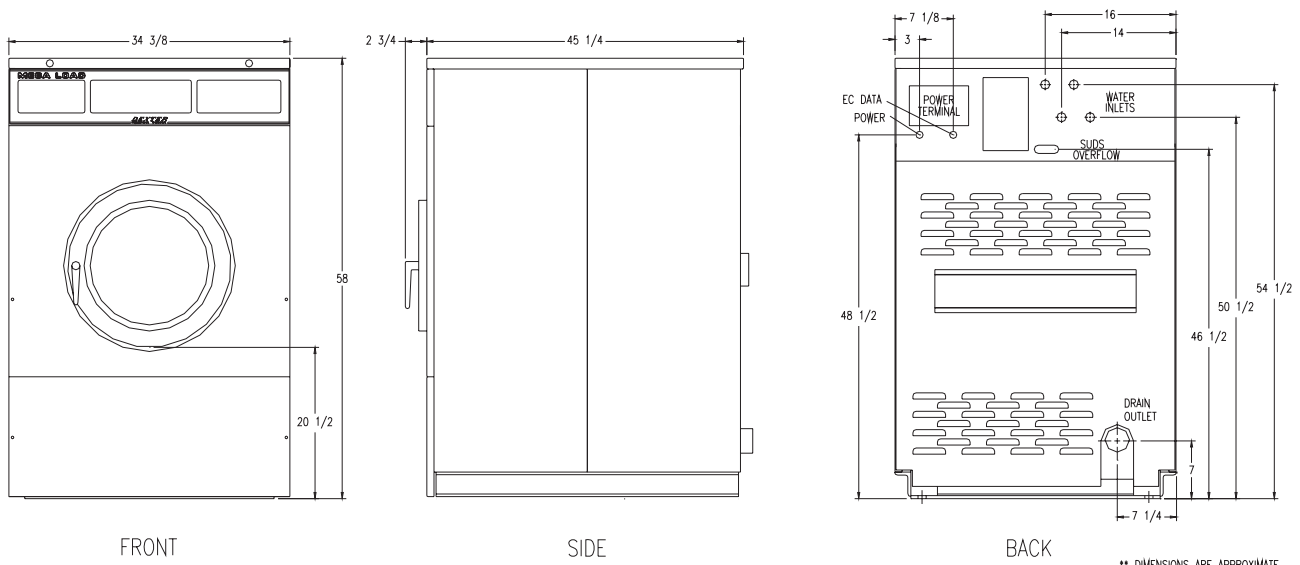

** DIMENSIONS ARE APPROXIMATE

T900 Mounting Pad Dimensions

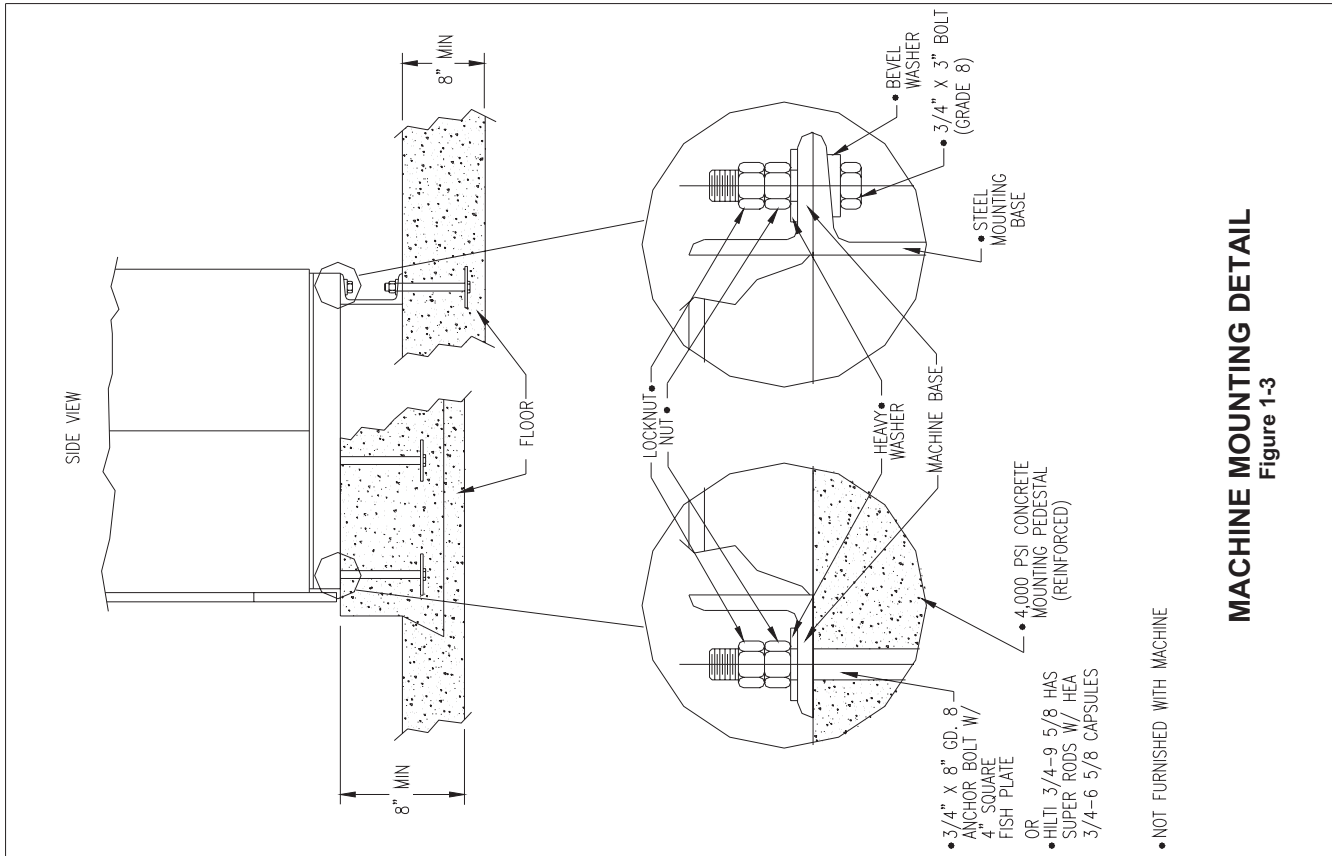

3/4" X 8" GD. 8 BOLTS
HEADED BY 4" SQ. FISH PLATE OR EQUIV.

OR

'HILTI' ADHESIVE ANCHORING SYSTEM.
USE HILTI 'HEA' 3/4-6 5/8 ADHESIVE CAPSULES
AND HILTI 'HAS' SUPER RODS 3/4-9 5/8
FOR MORE INFORMATION CALL
HILTI CUSTOMER SERVICE
1-800-879-8000

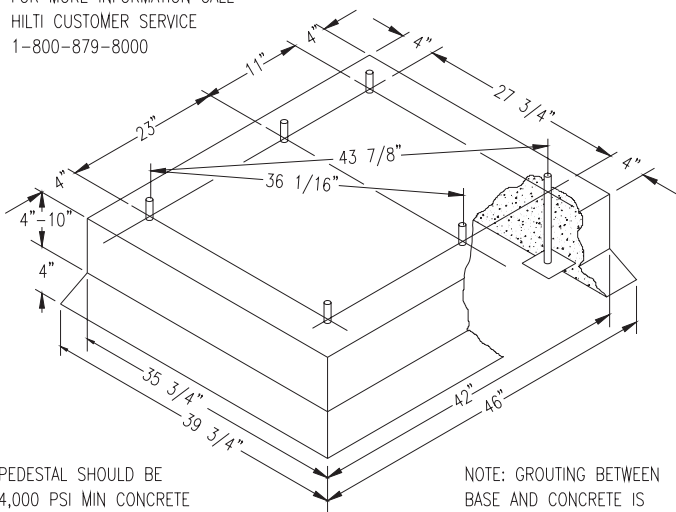

CONCRETE PEDESTAL MOUNTING

Figure 1-1

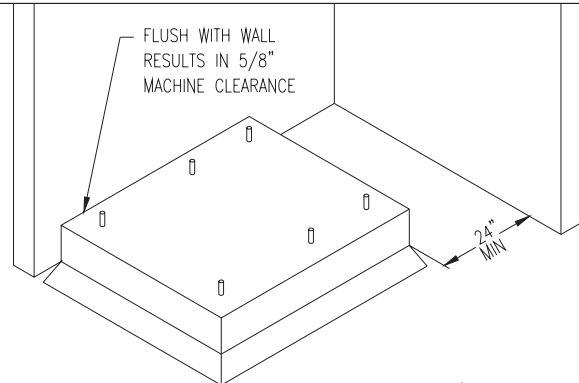

FLOOR OUTLINE

Figure 1-2

T1200 Mounting Pad Dimensions

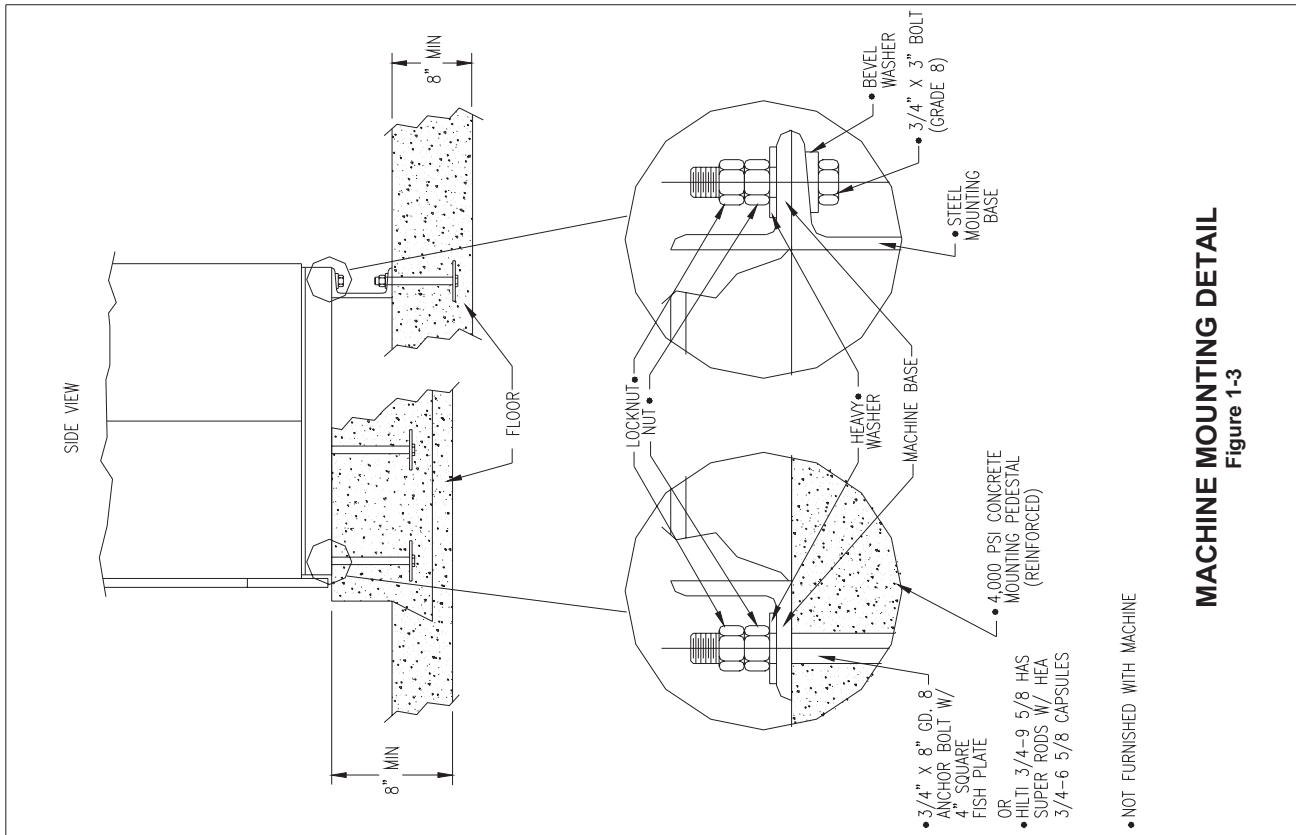

3/4" X 8" GD. 8 BOLTS
HEADED BY 4" SQ. FISH PLATE OR EQUIV.

OR

'HILTI' ADHESIVE ANCHORING SYSTEM.
USE HILTI 'HEA' 3/4-6 5/8 ADHESIVE CAPSULES
AND HILTI 'HAS' SUPER RODS 3/4-9 5/8
FOR MORE INFORMATION CALL
HILTI CUSTOMER SERVICE
1-800-879-8000

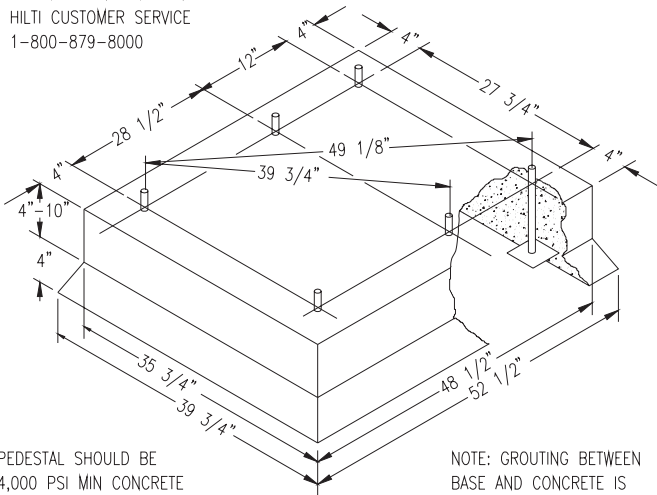

PEDESTAL SHOULD BE
4,000 PSI MIN CONCRETE
REINFORCED WITH
MESH OR RODS.

NOTE: GROUTING BETWEEN
BASE AND CONCRETE IS
REQUIRED.

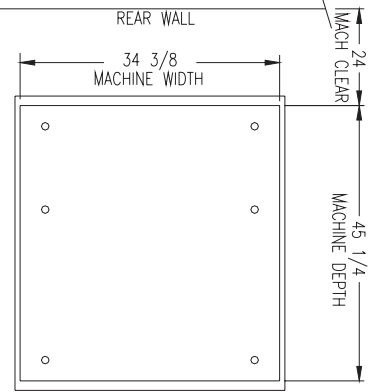
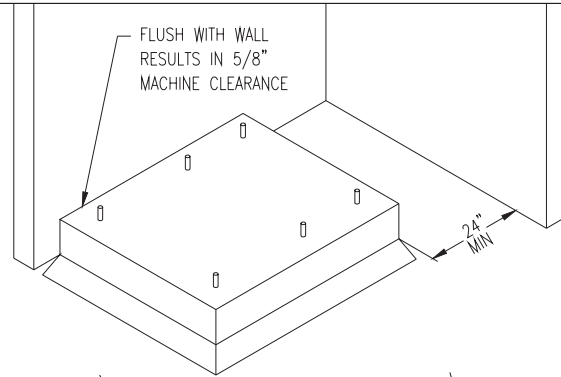

Section 2:

Machine Installation & Operating Instructions

Washer Installation

All washers must be installed in accordance with all local, state and national building, electrical, and plumbing codes in effect in the area.

Foundation Requirements

The washer must be securely bolted to a substantial concrete floor, or mounted upon a suitable base which is securely bolted and machine grouted to a substantial concrete floor. Care must be stressed with all foundation work to insure a stable unit, eliminating vibration. All installations must be made on sound concrete floors, (See installation specifications for the specific model.)

Mounting

A concrete pad or steel base which elevates the machine 4 to 6 inches above the floor level. To provide easy access to the loading door, it is recommended to allow a minimum of 18" of clearance behind the rear of the machine for service as is shown. SIX (6) bolts are required to mount the washer to the steel base or concrete pad. Grouting where base or machine makes contact with concrete is REQUIRED to achieve 100% surface contact and for warranty to be honored.

Note: Premanufactured bases are available from DEXTER factory (see sales dept.)

Mounting Bolts

The preceding pages illustrate the mounting dimensions for the machine and also show a typical concrete pad arrangement.

Note: Mounting bolts should be checked frequently to insure that they remain tight. The machine should be checked with a spinning load to be sure there is no unusual vibration or movement between the machine and the base or floor.

Proper Machine Grout Required Installation

Machine grout must be installed between base (if used) and concrete floor on all side rails and crossmembers. If using a base you must grout between base top and machine frame and all side rails and crossmembers.

Plumbing

Water supply hoses are furnished with each machine. The threaded connections on the hoses are standard garden hose type thread. Separate hot and cold water lines with shut off valves or faucets for inlet hose connections must be provided, maintaining 30 to 120 p.s.i. water flow pressure. The recommended water temperature is 140 degrees.

Drain

The drain outlet tube at the rear of the machine is 3" in outside diameter on models. Adequate fall for this gravity drain must be maintained for proper drainage.

Protective Film

The machine may have protective adhesive film on the front escutcheon area and the front and side stainless steel panels. The film may be peeled off before putting the machine into service.

Electrical

Dexter single/three-phase 208-240VAC 60 Hz washing machines are intended to be permanently installed appliances. No power cord is provided. The machine should be connected to an individual branch circuit not shared by lighting or other equipment. The connection should be sheathed in liquid tight flexible conduit, or equivalent, with conductors of the proper size and insulation. A qualified technician should make such connections in accordance with the wiring diagram.

Each unit should be connected to an individual branch circuit not shared by lighting or other equipment. Conductors of the proper size and insulation (suggested size below) should be used.

To Make Electrical Connections

Disconnect all power to the washer. Remove screw and lift out the cover located in the upper left corner of the machine (as viewed from the back).

- If power is 208-240-3PH-60Hz, connect L1, L2, L3 and ground. If there is a high leg it must be connected to L3. It is highly recommended to use a TVSS. (see Informative inside Washer)
- If power is 208-240-1PH-60Hz, connect L1, L2 and Ground.

NOTE: It is important that the grounding screw next to the power terminal block TB-1 be connected to a good external ground.

Controls Transformer

The controls transformer is located inside the control trough and steps a range of 208 to 240 volts down to 115 volts. There are two terminals on the controls transformer for the primary (incoming) power. Use the terminal marked "208V" for power supplies between 200 and 215 volts. Use the terminal marked "230V" for power supplies between 216 and 240 volts.

NOTE: transformer must be set at proper tap for proper operation.

Electrical Connections

Electrical power connections are made to the small terminal block located in the rear of the control trough. The terminal block is accessed by opening the top panel of the machine.

- 1 Phase or 3 Phase connections
- 208-240 volts, 60 Hz.
- 3 wire plus ground
- Suggested Minimum Wire Size -- 12 Ga.

Fusing Requirements:

Dual element time delay fuse or equivalent breaker of amperage specified below.

- 1 Phase or 3 Phase 15 amp
- WSVD-30

Rotation in extract as viewed through glass door at front of washer models WSVD-30 will be counter-clockwise.

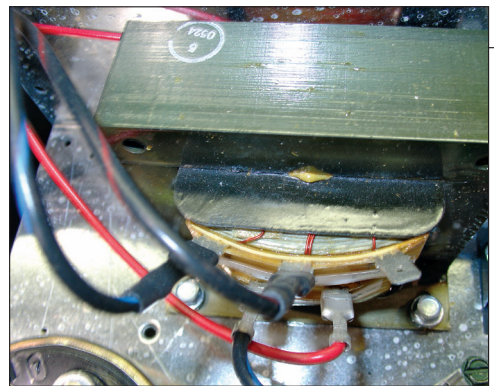
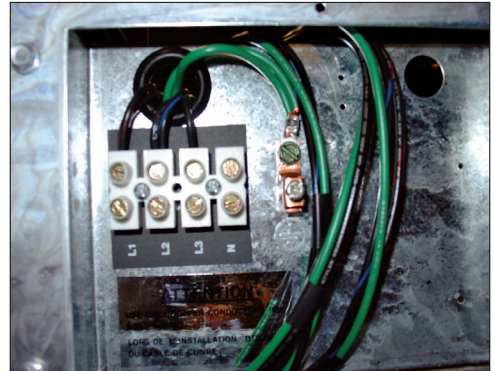

WARNING

Always disconnect electrical power to the machine before performing any adjustments or service.

Liquid Chemical Connection

In the left rear corner of the washer is the chemical injection assembly. This is where all chemical hose connections are made. The chemical hoses should be inserted into the round pvc pipe a minimum of 14" and a maximum of 18" to eliminate chemical buildup in the pipe and/or restrict water flow to the tub.



Injection Source Details

The washer control may be programmed to send output signals for a chemical injection system. There is a separate terminal block for connection of the external injection signals. For the injection sources, program codes 0 through 6 are as shown in the table below. Injection signal will trigger a 120 volt reading at rear terminal block for approximately 5-10 seconds and will start to trigger at about 10-15 seconds after start of fill bath. (Chemical Injection Signals are shown in the programming section.)

**208/240 VAC
Power Connections**

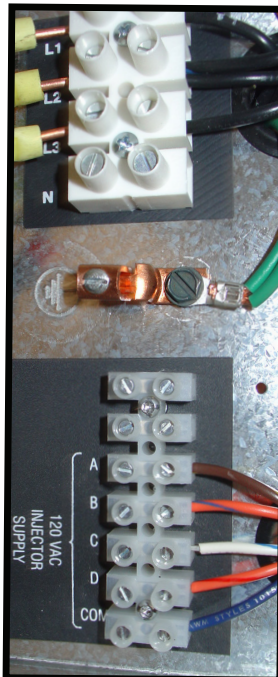

**L1
L2
L3
N (not needed)**

**120VAC Injector
Supply Connections
Power Connections**

**A
B
C
D
Common**

Dexter Recommended Connections

Detergent
Bleach
Starch
Sour/Softener

Controller Programmed Signals

1
2
3
4
5
6
0

Injection Terminal Block Connection

A
B
C
D
A and B
C and D
None

Note : The Wash Cycle programming mode will automatically exit and return to the Idle mode if no buttons are pushed for one minute.

Washer Operating Instructions

Safety Door Lock

This machine is equipped with a Safety Door Lock that locks the door closed from when the cycle is started until the cycle is complete. The door lock prevents opening the door for up to 3 minutes if the power is interrupted during the cycle.

Starting the Washer

- A. Load the items to be washed in the cylinder and latch the door securely. Be sure clothing does not get caught between the door gasket and tub front when closing the door.

NOTE: To close the door the handle must be in the horizontal position and then moved to the vertical position. After moving the door to the closed position, the handle must be turned down to the vertical position to latch the door for machine operation.

- B. Make the appropriate cycle selection for the wash load by pushing the up and down arrows on the touch pad. Preprogrammed Cycles 1,2,3,4,5, or 6. Each cycle is completely programmable and for instructions see next section in this manual.
- C. To manually add wash compounds, pour low-sudsing powdered detergent into the detergent dispenser on front of the machine. Rinse conditioners may also be added to the dispenser. The correct location of each is shown on the dispenser lid.
- D. To manually add bleach in Rinse, pour bleach in opening. Bleach light will come on during the wash bath only (location shown on dispenser lid) in top or front of washer.
- E. To start the washer, push the green "Start" button
- F. To pause for an extended soak, push the red Stop button for 1 second. To continue the cycle, push the green Start button. enough to reach down to water trap.
- G. To stop and clear the wash cycle, hold the red Stop button for 8 to 10 seconds.
- H. If automatic chemical injection systems are being used, make sure that chemical hoses are inserted correctly in the injection port located at rear corner at red cover. Hoses must be inserted long enough to reach down to water trap.

Safety Door Lock

If power is interrupted the Safety Door Lock delays opening the door until it is safe to do so. If power failure occurs or if power is interrupted during maintenance, it will be necessary to wait 2 to 3 minutes before the door can be opened.

End of Cycle

When the cycle is completed, the washer will stop, the End of Cycle Light will come on, the Buzzer sounds and the loading door will unlock. It can be opened by turning the door handle to the indicated position and pulling. Leave the clothes door open when the machine is not in use helps to eliminate odors that might build up during the wash process.

Detergent Measurements By Washer Model

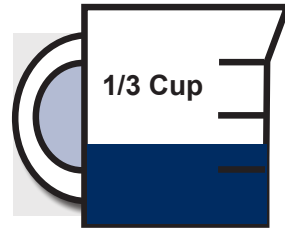

Maxi Load T-750 Washer

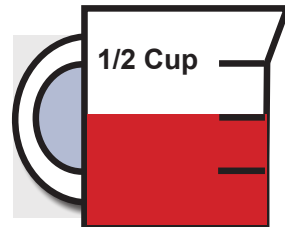

Mega Load T-900 Washer

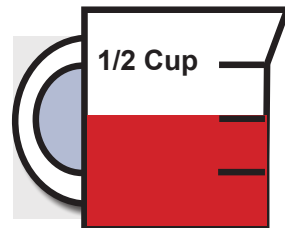

Mega Load T-950 Washer

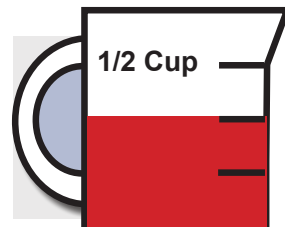

Magnum Load T-1200 Washer

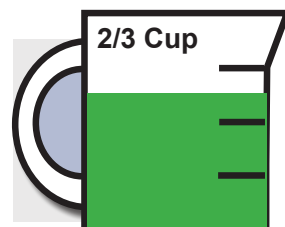

Magnum Load T-1450 Washer



Section 3:

Machine Programming Instructions

Bath Cycle Time "ct"

0 to 15 minutes for Prewash, Rinse1 and Rinse 3 to 15 minutes for Wash and Final Rinse. For the baths that can, if the time is set to zero, then that bath will be eliminated from the cycle.

Bath Water Temperature "t"

HH – hot, CH – warm, CC – cold, EE – no water. The owner can set the bath default. For the wash bath, the default is over ridden for that cycle by the customer when the temperature is selected.

Bath Water Level "L"

LO – low The owner can change the displayed value, but for a coinwasher only LO will be put into the cycle.

Bath Delay Fill "dF"

The selections are "d" for delay the bath time until water level is reached or "t" for decrement bath time during the fill.

Bath Spin Time "S"

0 to 10 minutes for Prewash, Wash, Rinse1 and Rinse2 1 to 10 minutes for Final Spin.

Bath "IS"

The owner can change the displayed value, but for a coin washer only 0 will be put into the cycle.

Washer 6 Default Cycles (Preset at Factory)

There are 6 pre programmed baths on the control which are set up at the factory. The formulas for each are shown on the following pages. Each of these 6 programs can be adjusted and saved as the owner needs.

Cycle 1: Sheets and Pillowcases (Health Care)

Bath	Bath Cycle Time (min.)	Water Temp.	Water Level	Delay Fill	Spin Time (min.)	Injection Source
Flush	3	CH	HI	d		
Prewash	2	CH	HI	d		
Wash	7	HH	LO	d	1	#1(Detergent)
Rinse 1	7	HH	LO	d	2	#2 (Bleach)
Rinse 2	2	CH	HI	d	1	
Rinse 3	2	CH	HI	d		
Rinse 4						
Final Rinse	4	CH	LO	d	4	#4 (Sour/Soft)

Cycle 2: Towels / Pads / Diapers (Health Care)

Bath	Bath Cycle Time (min.)	Water Temp.	Water Level	Delay Fill	Spin Time (min.)	Injection Source
Flush	3	CH	HI	d		
Prewash	2	CH	HI	d		
Wash	7	HH	LO	d	1	#1 (Detergent)
Rinse 1	1	HH	HI	d		
Rinse 2	7	HH	LO	d	2	#2 (Bleach)
Rinse 3	2	CH	HI	d	1	
Rinse 4	2	CH	HI	d		
Final Rinse	4	CH	LO	d	5	#4 (Sour/Soft)

Cycle 3: White Towels (Hotel / Motel)

Bath	Bath Cycle Time (min.)	Water Temp.	Water Level	Delay Fill	Spin Time (min.)	Injection Source
Flush						
Prewash						
Wash	7	HH	LO	d	1	#1(Detergent)
Rinse 1	1	HH	HI	d		
Rinse 2	7	HH	LO	d	2	#2 (Bleach)
Rinse 3	2	CH	HI	d	1	
Rinse 4	2	CH	HI	d		
Final Rinse	4	CH	LO	d	5	#4 (Sour/Soft)

Cycle 4: Guest Laundry (Hotel / Motel / Healthcare)						
Bath	Bath Cycle Time (min)	Water Temp.	Water Level	Delay Fill	Spin Time (min)	Injection Source
Flush	3	CH	HI	d		
Prewash						
Wash	7	HH	LO	d	5	#6(Detergent/Bleach)
Rinse 1	2	HH	HI	d		
Rinse 2	2	CH	HI	d		
Rinse 3	2	CH	HI	d		
Rinse 4						
Final Rinse	4	CH	LO	d	4	#4 (Sour/Soft)

Cycle 5: Rags and Mops (Hotel / Motel)						
Bath	Bath Cycle Time (min)	Water Temp.	Water Level	Delay Fill	Spin Time (min)	Injection Source
Flush	3	CH	HI	d		
Prewash	2	CH	HI	d		
Wash	2	CH	HI	d		
Rinse 1	7	HH	LO	d	1	#1 (Detergent)
Rinse 2	2	HH	HI	d		
Rinse 3	7	HH	LO	d	2	#2 (Bleach)
Rinse 4	2	CH	HI	d	1	
Final Rinse	2	CH	LO	d	5	

Cycle 6: Colored Cotton Linen (Hotel & Food Service)						
Bath	Bath Cycle Time (min)	Water Temp.	Water Level	Delay Fill	Spin Time (min)	Injection Source
Flush	3	CH	HI	d		
Prewash	2	CH	HI	d		
Wash	2	CH	HI	d		
Rinse 1	7	HH	LO	d	1	#1(Detergent)
Rinse 2	2	HH	HI	d		
Rinse 3	7	HH	LO	d	2	#2 (Bleach)
Rinse 4	2	CH	HI	d	1	
Final Rinse	2	CH	LO	d	5	

Washer Programming Instructions

THERE ARE TWO WAYS TO MODIFY PROGRAMMING OF THE V-SERIES OPL SIX (6) PREPROGRAMMED FORMULAS

Option 1: Programming can be accomplished manually using the machine controls or by connecting to the machine control using a PDA (personal digital assistant). For instructions on using a PDA with this washer control and software, please contact your local Dexter distributor. Please read below for manual programming instructions.

The keypad layout for the washer control is shown below.

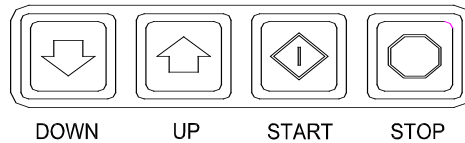

Option 2: Wash Cycle Manually Programming

1. Turn on the power to the washer.
2. Turn the Run/Program key to the Program position. Display will show "CO" and the "ADD BLEACH" will blink and will continue to blink during the programming mode.
3. Press the "DOWN" or "UP" buttons to select which cycle to alter. When the desired cycle number is displayed, press "START".
4. The display should now show a "b". The "b" and the cycle indicator lights indicate which bath is being selected to alter. Press the "UP" and "DOWN" buttons to select a bath to change and then press "START".



The indicator lights are shown above:

When "RINSE" is selected, "b r1" through "b r4" may be selected.
There may be multiple rinses that are indicated by br 1, br 2, br 3, and br 4

5. Each bath can be programmed with the following options. Use the "DOWN" and "UP" keys to select the desired setting and the "START" key to move to the next option.

To exit the programming of a bath, press the "STOP" button once and use the "UP" and "DOWN" keys select another bath. Press the "STOP" button again to select a different cycle to change. To end programming, turn the key to "RUN" position.

Rapid Advance Mode

To enter the Rapid Advance mode, turn the key CCW. The Rapid Advance setting is not marked next to the key, but turning the CCW until it stops selects this mode. The Rapid Advance mode can be entered from either the Idle mode or during the cycle. If the cycle has not yet started, press the "START" button. To rapid advance to the next step in the wash cycle, push both the "UP" and "START" buttons at the same time. The display will show an "Ad" (advance) in the display. The washer will advance to the next bath segment. The water will drain before the advance will occur and the time displayed may not be accurate.

- Notes:**
- The indicator lights will show to which segment the cycle has been advanced.
 - The cycle will continue in rapid advance mode even if the key is turned to "RUN" and/or removed.
 - Rapid advance cannot skip the final 1- minute tumble of the cycle, and the door lock may remain activated for up to 3 minutes after the cycle has been completed.
 - Chemical 120 volt signals will be lost after Rapid advance Mode has been activated until cycle resets. To exit the Rapid Advance mode, push and hold the STOP button.

Injection Source Details

The washer control may be programmed to send output signals for a chemical injection system. There is a separate terminal block for connection of the external injection signals. For the injection sources, program codes 0 through 6 are as shown in the table below. Injection signal will trigger a 120 volt reading at rear terminal block for approximately 5-10 seconds and will start to trigger at about 10-seconds after start of fill bath.

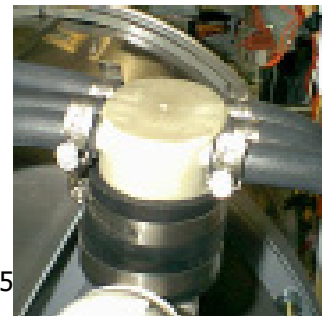
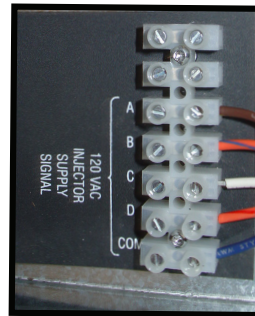

Dexter Recommended Connections Circuits	Controller Programmed Signals	Injection Terminal Block
Detergent	1	A
Bleach	2	B
Starch	3	C
Sour/Softener	4	D
	5	A and B
	6	C and D
	0	None

NOTE: The Wash Cycle programming mode will automatically exit and return to the Idle mode if no buttons are pushed for one minute.



Section 4:

Trouble Shooting

Common Troubleshooting Solutions

Symptom	Probable Cause	Suggested Remedy
Machine does not start	Power Supply	Check these areas: Circuit breakers, Voltage, Power leads, Power connections. Is front display LED showing a dollar amount.
	Door Switch	Check for continuity through door switch when door is closed. If no continuity, adjust or replace door switch.
	Control Breaker or Fuse	Check 1.5 amp (T-1200. uses 2.5amp) breaker or fuse for continuity. If no continuity, replace breaker or fuse.
	Control Transformer	Check voltage output from control transformer for 120VAC. If voltage is incorrect, replace transformer.
	Check PCB board	Check all wire connections for sure contacts.
	Check wiring between PCB	Check data cable phone type connectors unplug and VFD and replug with power removed.
	Check Relay PCB	Check all wire connections for sure contact.
	Check Door Solenoid	Check that 120 v power is at solenoid after start button is pushed.
Door does not lock	Check display for fault code	Does F1 show on the front of display. If yes follow tests described in fault code section.
	Door locking solenoid	Check to insure that solenoid is receiving 120VAC from main relay PCB. If it is, replace solenoid.
	Door Switch	Check for continuity through door latch switch when door closed. If no continuity, adjust or replace door switch.
Door will not open	Thermoactuator	Check to see if thermoactuator(s) and/or its mechanism is stuck or binding and not allowing the door lock solenoid to open. Check to be sure that the locking thermoactuator is not receiving 120VAC during the last 1 1/2 minutes of the cycle. Also check to see that the unlocking thermoactuator is receiving 120VAC during the last minute of the cycle. If the thermoactuators do not receive voltage at the correct times, change the timer. If the timing and voltage are correct, replace the thermoactuator.
Door will not open	Door Rod	Check to see that door rod from solenoid to lock ass'y is long enough to allow lock ass'y to disengage. If not, adjust rod.
	Door Lock Solenoid	Check that door lock solenoid is not stuck closed. If stuck, replace solenoid.
No hot water in detergent dispenser	Water Valve Coil	Check coil continuity at terminals and replace if no continuity. 120 V power only on for 20 second in wash bath.
	Water Inlet	Check water inlet screens for blockage and clean screens if necessary.
	Water	Check to insure that water is turned on and operating.
	P-20 Wire Harness	Check black & white harness.

Common Troubleshooting Solutions

Symptom	Probable Cause	Suggested Remedy
Hot water does not enter tub in wash	Water Valve Coil	Check coil continuity at terminals and replace if no continuity. Check for 120 V power from main relay PCB
	Water Inlet	Check water inlet screens for blockage and clean if necessary screens
	Water	Check to insure that water is turned on and operating.
	Blk or Wht wire at main controller	Check black or white wires at Molex plug on PCB at main controller and at relay PCB.
	Pressure Switch	Check pressure switch continuity between terminals . If no continuity, check pressure switch hose for obstruction. If hose okay, change pressure switch.
No cold water to tub in wash	Water Valve Coil	Check coil continuity at terminals and replace if no continuity.
	Water Inlet Screens	Check water inlet screens for blockage and clean if necessary.
	Water	Check to insure that water is turned on and operating.
	Blk or whit wire at controller and main relay PCB	Check black or white wires at Molex plug on PCB at main controller and at relay PCB.
	Pressure Switch	Check pressure switch continuity between terminal contacts. If no continuity, check pressure switch hose for obstruction. If hose okay, change pressure switch.
Water comes in but level does not rise	Drain Valve (open)	Check these areas • Drain valve blockage • Drain valve motor and gear train. If power but drain valve does not close, replace valve. • Power to the drain valve. If no power to drain valve, check (brn/yel) circuit for power.
	Blk or whit wire at controller	Check black and white wires at molex plug on main PCB controller and at main relay PCB
Water does not flush softener compartment.	Water Valve Coil	Check coil continuity at terminals and replace if no continuity.
	Water Inlet Screens	Check water inlet screens for blockage and clean if necessary.
	Water	Check to insure that water is turned on and operating.
Water does not flush softener compartment.	Pressure Switch	Check pressure switch continuity between terminals. If no continuity, check pressure switch hose for obstruction. If hose okay, change pressure switch.
Water level too high	Pressure Switch	Check for blockage in pressure switch hose. Check for pressure switch opening circuit across terminals . Replace switch if contacts do not open.
Water drains slowly	Drain System	Check hoses and drain valve for blockage. Clean of inadequate size. if necessary. Check building drains for blockage

Common Troubleshooting Solutions

Symptom	Probable Cause	Suggested Remedy
Machine does not turn	VFD	Check VFD by removing inspection panel and record any numbers or letters displayed. If no display turn power off to machine at breaker for 2 minutes and turn power back on to reset. If still no display replace VFD
Machine tumbles in one direction	VFD	Remove inspection cover at rear and record in only numbers or letters displayed. See fault code section for more info.
	VFD	Inspect yellow enable wires from main relay PCB and at VFD
Excessive vibration	Mounting System	Check these areas: • Strength of mounting structure, concrete or base. • Mounting bolts may be loose and need tightening.
	Drive Belt	Worn drive belt can cause vibration and noise.
	Loading	Note: Small loads contribute to out of balance loading and increase vibration.
Machine does not spin	Pressure Switch	Check pressure switch for continuity across terminals #21 & #22 indicating pressure switch has reset to the empty position. If no continuity, change pressure switch.
Machine starts and does not operate	VFD	Check yellow enable wires from relay PCB P13 & motor P14 to VFD advances through cycle are connected. Check fault code on VFD before removing power from the drive. Check orange P-15 wire for signal from door switches.
Machine does not stop	Main PCB	Main PCB controls time cycle at end of cycle
	Braking Resistors	Check braking resistors for continuity. Verify ohms resistance by Molex.
Water leakage around loading door	Door Adjustment	Door may need adjustment due to abuse or wear. Check tightness around perimeter using a dollar bill. Adjust left to right tightness by shims at door lock or hinge side. It is important to center gasket to tub opening before tightening door to hinge bolts. Chalk may be used on tub front to show point of contact with tub. If gasket is deformed, worn, or damaged, replace. Refer to parts section for door gasket expander kit.

Troubleshooting Machine Fault Errors

The following are descriptions of fault codes that will appear on the front of the washer. There is a chart format that shows what fault code that will be displayed at washer front. The codes displayed may or may not stop machine operation.
PLEASE NOTE: CHECK DRIVE FAULT CODE BEFORE POWERING MACHINE DOWN!

Fault#	Description	Customer Action
F1	The door failed to close and lock or The door failed to remain locked during the cycle.	Check VFD fault code before turning off. Check to hear if door solenoid engaged. Turn off the power to the washer. Check wire connections to door /lock switches. Check wire connections from switches to controller. Check P-4 wire connections at PCB controller. Adjust the door lock mechanism. (See service manual)
F2	The washer tub does not fill with water within 7 minutes. The wash cycle will continue. The F 2 will flash three times, then wait for 30 seconds. The error will clear at the end of the cycle.	Turn off the power to the washer. Check the operation of the water valves. Check the incoming water pressure. Check for blocked or restricted water flow. Check to ensure the drain valve is functioning properly. This error will occur on 18# washers when water level is set for high (the pressure switch in 18# washer is only one level).
F3	Memory error in controller. The memory checksum is wrong.	Check VFD fault code before turning off power. Try to clear the fault with the Palm. Try a soft Reset of the controller with the white button. If problem. Replace PCB controller.
F4	Washer controller communication error	Check VFD fault code before turning off power. Try the data cable first. Move around cable and remove any side loading tension from data cable connector ends. Check connection P25/24/23 to P15. Turn power back on to the washer. If the problem returns, replace the PCB washer controller.
F5	Pressure Switch error (only OPL) - when the high level sensor indicates full but the lower one indicates empty. The wash cycle will continue. The F 5 will flash three times, then wait for 30 seconds. The error will clear at the end of the cycle.	Check VFD fault code before turning off power. Check the pressure switch.(Ohm out contacts). Check pressure switch connections to ensure they are all making good contact. Check the Molex type harness connector to ensure no wire been pushed out of the Molex type housing that it is shorting or not connecting.
F6	Wrong washer size for drive type.	Check VFD fault code before turning off power. If the controller was installed in a different size machine before being installed in this machine, a problem can occur. If someone has been doing repairs on the washer, check for the correct size drive. It can also be caused by pressure switch harness. Check to ensure the correct harness in installed. The control can be reset by holding program button on controller during startup (soft reset). Check orange wire at Molex connector on controller coming from pressure switch or replace pressure switch harness.

Fault#	Description	Customer Action
F7	Wrong size drive installed	Check VFD fault code before turning off power. Check to ensure all the harnesses are properly connected to the controller. Check to ensure the VFD drive horsepower is proper for this size of washer. The control can be reset by holding program button on controller during startup (soft reset) Check orange wires at molex connector on controller coming from pressure switch.
F8	The washer tub does not empty within 7 minutes. The wash cycle will continue. The F 8 will flash three times, then wait for 30 seconds. The error will clear at the end of the cycle.	Check VFD fault code before turning off power. Check to ensure the drain valve is operating properly (slow drain has potential to cause this code). Check to ensure the pressure switch tube is clear of any blockage, and the pressure switch is operating properly. Check the pressure switch harness.
F9	The washer tub does not reach the spin target frequency within 150 seconds. The wash cycle will continue. The F9 will flash three times, then wait for 30 seconds. The error will clear at the end of the cycle.	Check VFD fault code before turning off power. Check to ensure the drain valve is operating properly (slow drain has potential to cause this code). Check to ensure the pressure switch tube is clear of any blockage, and the pressure switch is operating properly. Check the pressure switch harness.
F10	After a spin the washer tub does not stop within 150 seconds.	Check VFD fault code before turning off power. Inspect the braking resistors and measure the resistance. Check connecting wiring from braking resistor to the drive mounted in the top of the washer. Reset the drive and try again. Possibly incorrectly programmed drive.
F11	The drive size setting has changed.	Check VFD fault code before turning off power. Check to ensure all the harnesses are properly connected to the controller. Check to ensure the drive horsepower is proper for this size of washer. If no one has worked on machine very recently then PCB controller or VFD may need to be replaced. Do a soft reset before and after either VFD replaced.
F12	Washer controller internal error	Check VFD fault code before turning off power. Turn off the power to the washer. Wait one to two minute. Turn on the power to the washer. If problem reappears, contact your Dexter Authorized Representative.

Fault#	Description	Customer Action
F13	The variable frequency drive (VFD) and the washer computer are not communicating.	<p>Check the data communication cable between the washer computer and the variable frequency drive (VFD).</p> <p>Step 1: Make sure the cable did not become unplugged during operation.</p> <p>Step 2: Make sure that the cable is not being pulled sideways at either the washer controller, or the VFD, plug end. If both ends of the communications cable are plugged in the washer computer and VFD and there is no tension on the communications cable pulling it from side to side, then replace the cable.</p> <p>Step 3: Inspect both female connection points at PCB controller and at VFD. These may need replacement if they cannot be reset.</p>
F14	Over-current on the drive or motor.	<p>Step 1: Check to make sure the washer cylinder turns freely by hand. If it turns freely, continue to step 2. If it does not, remove the belt and see if the motor turns freely by hand. If the motor turns freely, then check for obstructions in the cylinder or check the bearings. If the motor does not turn freely, replace the motor.</p> <p>Step 2: Check the motor wires for a short circuit between leads. If there are motor leads that have conductors touching, separate them and insulate them. If the wires are broken, splice them together or replace the motor.</p> <p>Step 3: Check braking resistors to see if they measure the correct resistance. If a resistor does not measure the proper value, replace it.</p>
F15	The variable frequency drive (VFD) senses that the internal voltage is too high. The source of the problem can originate from two different areas. Area 1: The input voltage can be too high, or there may be a high level of electrical noise. Area 2: The motor can be generating a voltage that is acting like an input to the VFD output motor terminals.	<p>Step 1: Measure the supply voltage to the VFD on the L1, L2 (or N), and L3 (if connected to three phase power). the supply voltage should be from 187 to 264 VAC or 108 to 132 VAC for a 120 VAC VFD. Also make sure the supply wires on L1, L2 (or N) and L3 (if connected to three phase power) are securely connected.</p> <p>Step 2: Check the braking resistor connections at the VFD. The terminal screws should be tight. Once of the braking resistor wires should be connected to terminal B2.</p> <p>Step 3: Measure each braking resistor separately to make sure they are the correct resistance. (200 for 1 and 2 Hp VFD and 160 for 3 Hp VFD).</p> <p>Step 4: If you have a 240 VAC, high leg voltage supply, try disconnecting the high leg. If this cures the problem, either leave the high leg disconnected, connect a transient voltage surge suppressor (with some form of filtering) at the voltage supply panel, connect a line choke on the high leg or install a VFD filter.</p>

Fault#	Description	Customer Action
F16	The temperature sensor inside of the variable frequency drive detects that the internal temperature is too high.	Step 1: Make sure the cooling fins on the VFD heatsink and the ventilation louvers on the VFD cooling fan cover are clean. Step 2: Start a washer cycle and make sure the VFD cooling fan operates after the cylinder starts turning.
F17	Overload of the drive or motor	(Check drive fault code before powering down). Check the washer motor to ensure it turns freely. Check the wiring for loose connections to the drive and motor. Measure the braking resistor values. Check for damaged motor wires. Check V-Belt tension and adjust to 1" deflection at center. Check braking resistors.
F18	Ground Fault to the drive	Check VFD fault code before turning off power. Check the wiring connections to the drive and motor. Check the ground wiring of the drive, motor and incoming connection to ensure a proper ground is present. Check for damaged motor wires.
F19	Low Voltage to the drive	Check VFD fault code before turning off power. Turn the power off to the washer. Check the wiring connections to the drive and motor. If no problem is observed, turn on power to the washer and test. (See Note) Measure the incoming line voltage.
F20	Internal drive error	Check VFD fault code before turning off power. Turn the power off to the washer. Wait one minute. Turn the power on to the washer. If problem reappears, contact your Dexter representative.
F21	Data error on communications between the controller and drive Internal drive error # 32. This error also has CEXX errors associated with it that are presented on the drive display.	The CE errors are communications errors. Data Cable noise can cause the majority of these errors. Check VFD fault code before turning off power. Check the data cable between the controller and the drive. Replace data cable if it appears damaged and fault appears again. Please note that this fault will occur if you turned main power off and on to quickly. (See Note below)

Warning codes F22 - F28: These codes indicate that a component (VFD, relay PCB, injection relay PCB, water valve) has been replaced, added, or removed and you will need to soft reset the PCB controller board to reset the main controller to operate properly.

Fault#	Description	Customer Action
F22	Future use	No action required
F23	VFD has been replaced, disconnected, or removed.	Soft reset control.
F24	Injection relay PCB has been removed or loose connection.	Soft reset control.
F25	Optional water valve PCB removed or water valve has been replaced .	Soft reset control.

F26	VFD unit has been added or loose connection.	Soft reset control.
F27	Injection relay PCB has been added to machine or loose connection.	Soft reset control.
F28	Optional water valve PCB has been added or loose connection	Soft reset control.
<p>Note: Whenever power is turned off to the washer, it must remain off for three minutes for drive to reset. The washer will not operate correctly if this is done improperly. This will allow most fault codes to reset that are displayed at washer front. A fault code F-13 or F-21 will appear on front display if this procedure has not been reset correctly. Note: Should a power loss occur during cycle and then power returns, P U S H will be displayed and customer must push a temperature selection button to continue the cycle.</p>		

Drive Motor Inverter Type Motor-Winding Resistance Chart

T900 C-Series Washer (208-240 only)

Motor	Winding	Wire #	Resistance	
			Minimum	Maximum
T900 1ph or 3ph 60hzMain (wash & spin)		T1 & T2	2.4	2.8
Dexter #9376-308-001		T2 & T3	2.4	2.8
Marathon #		T1 & T3	2.4	2.8

T1200 C-Series Washer

Motor	Winding	Wire #	Resistance	
			Minimum	Maximum
T1200 1ph or 3ph 60hzMain (wash & spin)		T1 & T2	.944	1.097
Dexter #9376-329-001		T2 & T3	.944	1.097
Marathon #		T1 & T3	.944	1.097

NOTE: Resistance values are measured at the stator. Values at the end of the motor wiring harness may be slightly higher.

Variable Frequency Drive Control

Digital Readout Faults

Fault#	Description	Customer Action
CE1	VFD received an illegal command. Possible controller problem	Reset drive.
CE2	Illegal data address, VFD received an address not available to the controller.	Reset drive.
CE3	Illegal data value received at VFD. Possible controller problem.	Reset drive.
CE4	VFD unable to perform the requested action. Possible controller problem.	Reset drive.
CE6	Time frame between commands is too short. Possible controller problem.	Reset drive.
CE9	Internal checksum error. VFD problem.	Reset drive.
CE10	Watch dog timer. Command not received from the controller every 6 seconds	Reset drive.
CE11	Frame error. Possible Baud rate issues between VFD and controller	Reset drive.
CE12	Command message is too short. Possible controller problem	Reset drive.
CE13	Command message is too long. Possible controller problem	Reset drive.
CE14	Command message includes unused characters. Possible controller problem.	Reset drive.

Normal operation of the VFD: VFD display shows operating frequency first very quickly then changes to F0.0 at time power is returned. This will stay displayed until the VFD receives a command from main control PCB. (Pushing start button) A CE-10 fault will display at drive if improper communication between PCB and VFD has occurred.

Note: Resetting a fault code on front of washer: Turn the power off to machine (machine will need to remain off for up to three minutes).

SOFT RESET : is accomplished by pushing the white button located on the Main controller PCB board and simultaneously turning power on to machine. This will reset main controller to factory default settings.

Please record any modified information that has been inserted in memory before attempting to Soft Reset the PCB.

CE5, CE7 and CE8—Reserved by DELTA

Variable Frequency Drive Control

Digital Readout Faults

Fault#	Description	Customer Action
OL or OU	Overload of the drive or motor	(Check drive fault code before powering down). Check the washer motor to ensure it turns freely. Check the wiring for loose connections to the drive and motor. Measure the braking resistor values. Check for damaged motor wires. Check V-Belt tension and adjust to 1" deflection at center. Check braking resistors.
GF	Ground Fault to the drive	Check VFD fault code before turning off power. Check the wiring connections to the drive and motor. Check the ground wiring of the drive, motor and incoming connection to ensure a proper ground is present. Check for damaged motor wires.
LU	Low Voltage to the drive	Check VFD fault code before turning off power. Turn the power off to the washer. Check the wiring connections to the drive and motor. If no problem is observed, turn on power to the washer and test. (See Note) Measure the incoming line voltage.



Section 5:

Machine Service Procedures

Top Panel Removal Top Soap Dish

- Step 1:** Remove 4 screws that hold detergent dispenser to top panel. (for T750, T900, T950)
- Step 2:** Unlock top panel lock.
- Step 3:** Raise top panel, slide to the rear to release from back clips and lift off.

Top Panels Removal Front Soap Dish

- Step 1:** Unlock top panel locks.
- Step 2:** Raise front top panel, slide forward to release from rear top panel.
- Step 4:** Remove 5/16 bolt from hold down brackets, (rear top panel front edge to each side panel.
- Step 3:** Raise rear top panel, slide to the rear to release from back clips and lift off.

Front Panel Removal

- Step 1:** Remove 2 screws between front panel top and front (located behind control panel).
- Step 2:** Remove the two or four screws in the middle of the front panel.
- Step 3:** Pull panel out at the bottom to about a 45 degree angle to detach the top lip and remove.

Back Panel Removal

- Step 1:** Remove all screws holding back panel in position except the bottom row.
- Step 2:** The bottom row of screws are slotted and only need to be loosened and to lift off panel.

NOTE: The back panel is not only a safety requirement but also contributes to the rigidity of the cabinet.

Drain Valve Access

For access to drain valve, remove lower service panel. The drain valve is a ball type and is powered closed by the drain valve motor. It is mounted under the washer tub on the left side. It is spring loaded open. If power is interrupted to the washer, the motor releases the sealing ball, allowing the drive spring to open the valve. With the valve open, all water in the washer will drain out.

Drain Valve Cleaning

- Step 1:** Loosen the clamp on the tub hose at the drain valve end and remove the hose from the drain valve.
- Step 2:** Loosen the drain hose clamp on the back of the drain valve. Remove two drain valve mounting racket screws from the frame of the washer.
- Step 3:** **Disconnect red & black wire connection at clear connector.**
- Step 4:** Remove the drain valve and bracket assembly. Unplug the wiring after the drain valve is removed from the washer.

Detergent Dispenser (T-750, T-900, T-950)

Remove top panel to access dispenser. (see Removing Top Panel) Detergent is flushed from the front of the compartment and fabric softener is flushed from the back. There will be a small amount of water left in the fabric softener compartment after each use.

Vacuum Breaker (also called an air gap)

In the left rear of the cabinet is the vacuum breaker. It guides the water to the tub and dispenser and prevents a back flow of water.

Water Valves

Remove top panel to access water valves. (see Removing Top Panel) The two dual outlet water and/or single coil valves are mounted to the rear channel with two screws each. Always check inlet screens to be sure that they are clean. Disassembly requires the removal of two solenoid screws and three valve body screws. Below the solenoid coil is a solenoid guide, armature, armature spring and diaphragm. All valve parts are available individually or as a complete unit.

Door Lock Assembly Operation

After loading the clothing, the door should be closed and latched. The locking cam on the door contacts the latching switch actuator which closes the latching switch. The specified number of coins should now be added to start the washer. The solenoid pulls up on the locking pawl by use of a linkage rod. The locking pawl has two jobs. The first is to lock the door. This is accomplished by blocking the locking cam on the door so that it can't rotate to unlock. The second job is to close the two piggyback lock sensing switches. These switches control power to all of the controls. If the door unlocks for any reason, these two switches will stop the machine. When the door handle is 1/4 to 1/2 of an inch from its fully closed position, the latching switch should close. The two piggyback lock sensing switches should be open when the door is unlocked and should be closed when the door is locked.

Accessing the Door Lock Assembly

After removing the front panel and masking ring, the door lock assembly can now be accessed.

Adjustment for Door Lock Assembly

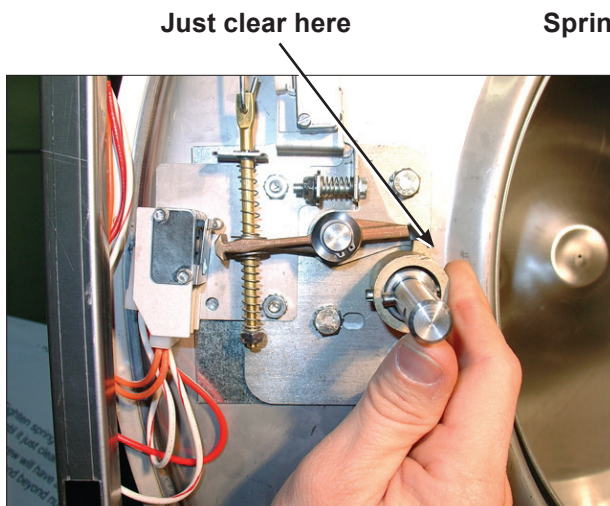

Step 1: Set door cam over pin. Here you can see the door cam away from the door lock assembly.

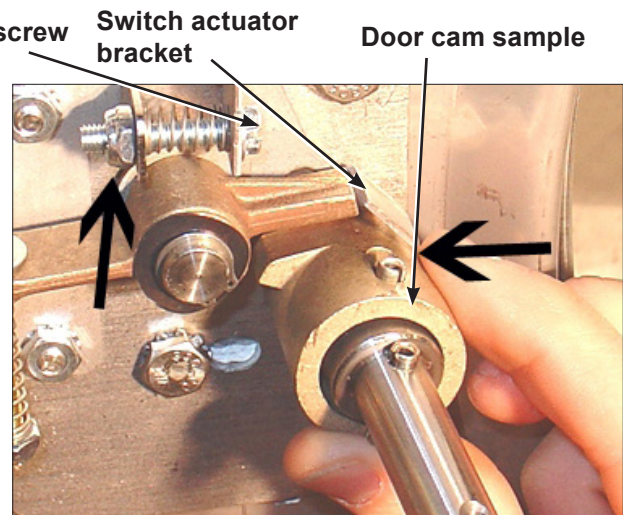

Step 2: Tighten spring screw on switch actuator bracket arm until it just clears cam OD. at base of door lock assembly.

Adjustment to this bracket usually is not necessary as next step is used more in field.

Flat blade screw on door switch latching

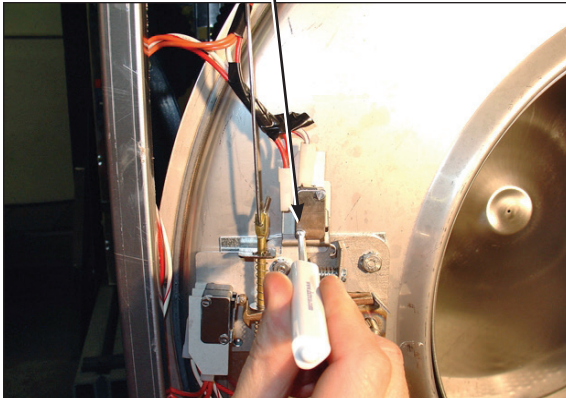

Step 3: With switch actuator bracket adjusted you will now need to adjust single switch by loosening 2 flat blade screws and allowing swivel of switch. Move switch towards above bracket until it actuates. Now tighten flat blade screws. Use a .040 thickness gauge to insert between bracket and switch and the switch should close and open again upon removal of thickness gauge.

Door cam check position

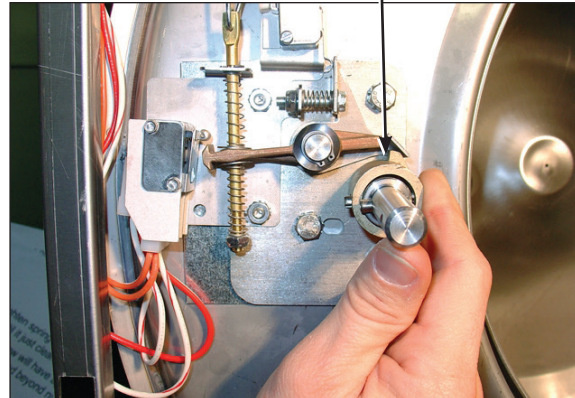

Step 4: Check for switch actuation at partial turn of cam as in operation above. Door handle goes from horizontal to six o'clock vertical.

Door lock rod Locking pawl blocking

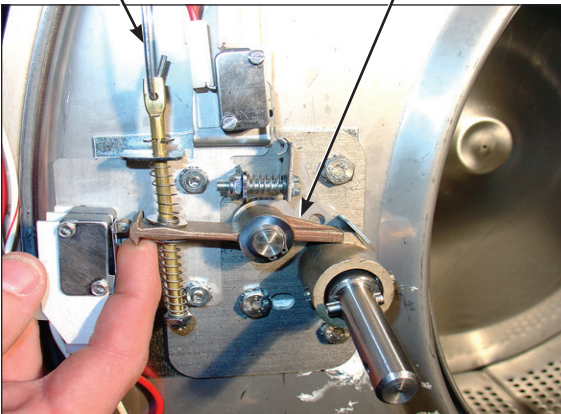

Step 5: Check that lock pawl arm swings to cam lobe to lock position.

Adjustment screw for (piggyback switches)

Top of flat end of locking pawl.

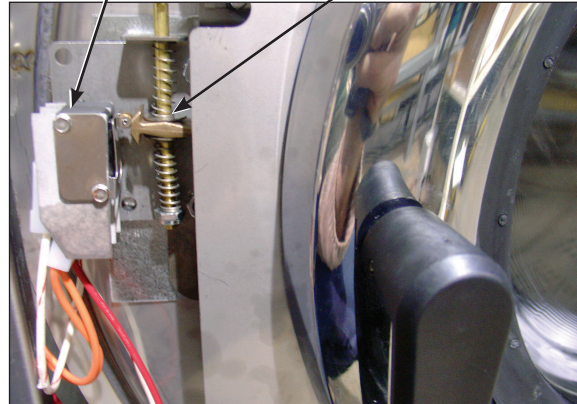

Step 6: The lock stacked switches (piggyback) must be adjusted as door lock solenoid pulls up on door rod and locking pawl is now blocking door cam from turning and is in full up position. The stacked switches (piggyback) have a single actuator arm and it must actuate when single actuator roller wheel rolls to flat side of locking pawl. You will also notice a .040 gap between actuator arm and switch bodies.

Note: Both stacked switches must operate together!

Adjusting the Loading Door

The door can be adjusted by changing the number of shims behind the door hinge and the door lock assembly. The vertical fit of the door to the tub can be altered by loosening the door hinge bolts and raising or lowering the door before retightening. It is important for the door to be centered on the tub front. By chalking the front of the tub and closing the door to transfer that line to the gasket, the centering can be evaluated. It is also important for door pressure to be similar around the door perimeter. Door pressure can be evaluated by inserting a dollar bill in several positions and tugging on it. See Parts Section for kit to increase door sealing pressure.

Loading Door Removal



Step 1: Support door to prevent dropping.



Step 2: Remove 2 bolts holding the lower leaf hinge and set door off.

Loading Door Hinge Removal

Step 1: First remove loading door, front panel, and trim ring.



Step 2: Remove 3 screws holding door hinge. Shims may be present between hinge and tub front. The number may be increased or decreased to adjust right side door pressure.

NOTE:
Door hinge mounting bolts penetrate tub front and require silicone sealer applied to holes when reinstalling.

Loading Door Disassembly

Step 1: Remove the loading door as outlined above. Lay the door on a flat surface with the glass down

Step 2: While holding down on the door glass, lift up on the door ring and roll back the lip of the gasket with your fingers.

Step 3: Work all the way around the gasket and the glass is out.

Loading Door Reassembly

Step 1: Lay the door ring face down on a flat surface. Start the glass into one side of the door gasket.

Step 2: Use one hand underneath to push the gasket out and the other hand on the top pulling the gasket in place

Step 3: The front lip of the door gasket should be checked for proper seating.

Control Panel Name Plate Decal

The name plate on washer front is adhesive backed.

Control Panel Name Plate Removal

The name plate may be removed by simply peeling it off.

Re-Installation of Name Plate

Step 1: Remove any remaining glue from the control panel.

Step 2: Before removing the paper backing from the name plate, check fit to the control panel. The program push buttons are the locating guides.

Step 3: Remove the paper backing from the right side of the name plate, position it on the panel and press right end into place. Peel the backing from the left end and press into place.

Door Locking Gear Motor Assembly

The door locking gear motor is rotated shut with control voltage to lock the door and releases when voltage is removed. It is located in the left front corner of the washer. (Original locking solenoid models can be converted to the new assembly)

Thermoactuators

The thermoactuators are a safety device that keeps the door from immediately unlocking if power is lost while the machine is operating. They are mounted under the door locking solenoid.

Lock Thermoactuator

Control voltage is applied to the lock thermoactuator at the beginning of the cycle making it extend and block the door locking gear motor. This keeps the door locked for approximately two minutes after a power failure occurs. The lock thermoactuator does not delay the door opening at the end of a normal cycle.

Unlock Thermoactuator

To insure that the lock thermoactuator has retracted by the end of the cycle, one minute prior to the end of the cycle, the unlock thermoactuator is powered with control voltage making it extend and unblock the door locking gear motor.

Drive Belt Removal

Turn the drive pulley while applying pressure to the drive belt until it rolls off of the basket pulley first and then remove from the motor pulley. Be cautious not to drop the motor which could unhook the tension assembly.

Reverse this procedure for installation.

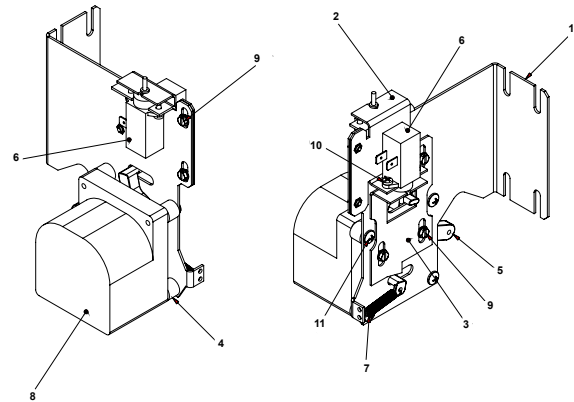

Door Lock Gear Motor

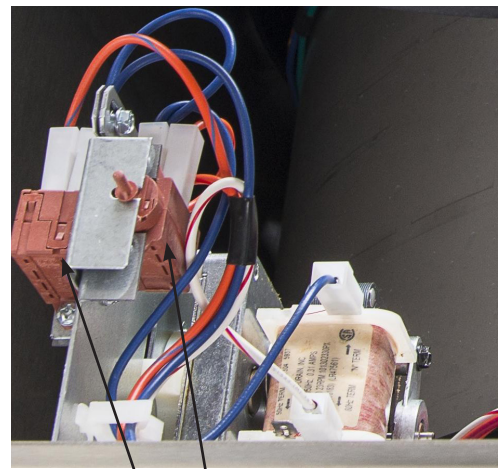

Thermoactuators

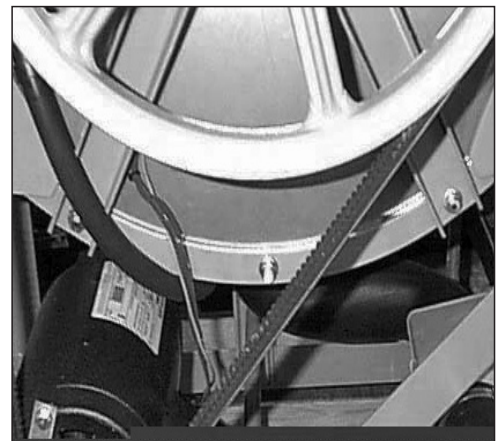

Drive Belt

Cylinder (basket)

- Step 1:** Remove the top panel as described previously.
- Step 2:** Remove lower service panel as described previously.
- Step 3:** Remove front panel as described previously.
- Step 4:** Remove masking ring as described previously.
- Step 5:** Remove door lock assembly. (Leave wires & pull rod in place)
- Step 6:** Remove clothes door.
- Step 7:** Remove tub front clamp ring.
- Step 8:** Remove tub front. Use a flat screw driver to pry the tub front loose.
- Step 9:** Remove the rear access panel.
- Step 10:** Remove the drive belts.
- Step 11:** Remove drive pulley. Remove 3 retaining screws. Insert (3) 3/8 16 x 2" screws into the threaded removal holes. Alternately tighten these screws evenly to pull the pulley off.
- Step 12:** Remove pulley hub. Drive a flat screw driver into the slot in the hub and pull it from the shaft.
- Step 13:** Install cylinder puller. (Snap On part #CJ-84-C) Be sure to thread a 5/8-11 NC bolt into the end of the cylinder shaft to protect the threads. Push the basket out.

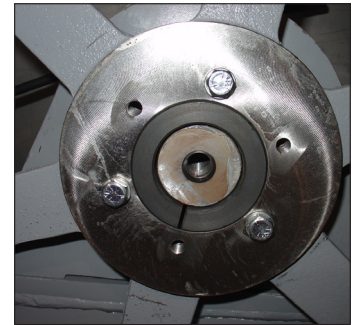
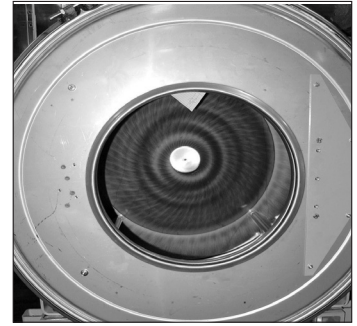

Bearing Housing Assembly

Removal

- Step 1: Remove cylinder from washer (see Cylinder (basket) removal).
- Step 2: Remove 6 7/16" tub back to bearing housing cap screws.
- Step 3: Remove 6 3/4" bearing housing to frame bolts.
- Step 4: Remove bearing housing from frame.
- Step 5: Remove the retaining ring next to the front bearing.
- Step 6: The bearings are pressed into the housing and must be pressed back out.

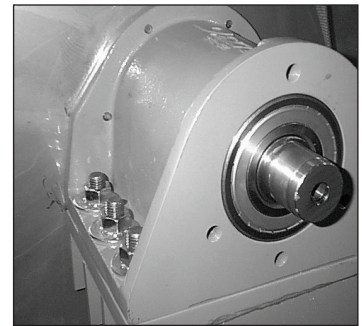

Reassembly

- Step 1: When installing new bearings into a bearing housing, first press the front (large) bearing into the housing until it bottoms and install the snap ring. With the bearing spacer in place, press the rear bearing in until the spacer is snug between the two bearings.

NOTE: If the tub-back water-seal mating ring has been moved it must be cleaned and resealed

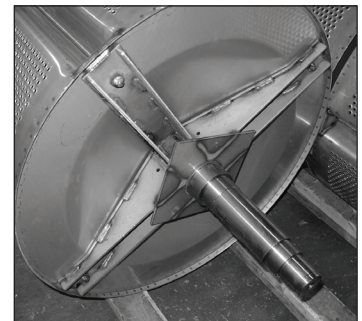

Water Seals

Replacement

- Step 1:** Remove cylinder from washer (see Cylinder (basket) removal).
- Step 2:** Remove water seals from the seal mounting plate on the cylinder shaft. These are removed with your fingers.
- Step 3:** The primary and secondary seals that mount on the sealing ring may be slid over the shaft and seated on the metal sealing ring with your fingers. In the unlikely event that the metal ring that mounts these sealing rings were to be damaged or moved, a new one would need to be pressed on. The seal mounting ring must be pushed against the stop on the shaft. After installing the seals, lubricate the faces of the seals with silicone grease.
- Step 4:** Install cylinder (see Cylinder (basket) reassembly).

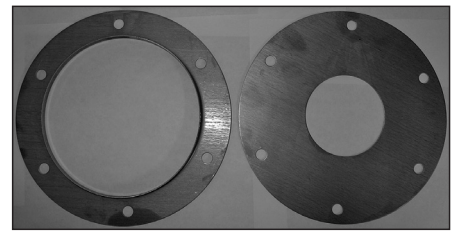

Guard Ring & Mating Ring

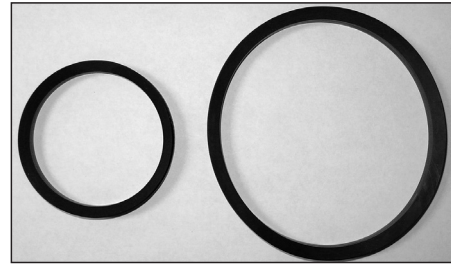

Seals

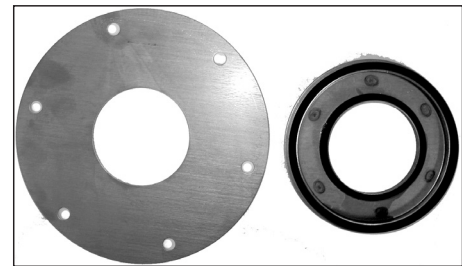

Mating Ring & Mounting Ring

Outer Tub

Removal

- Step 1:** The outer tub can easily be removed when the tub front, cylinder and bearing housing has been removed as outlined previously.
- Step 2:** At that point the only attachments to the chassis are the two front strap mounting bolts.

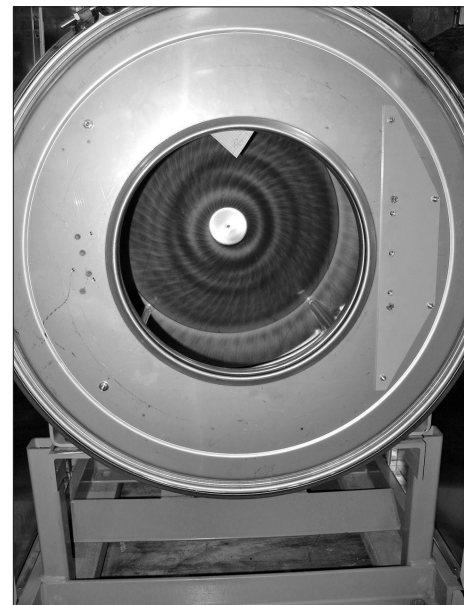

Reassembly of the Cylinder

- Step 1:** Use the hub of the drive pulley, a stack of 5/8" flat washers and a 3" long 5/8" bolt to pull the cylinder shaft through the bearings. After the 3" bolt a 2" long bolt will be required to finish pulling the cylinder shaft through.
- Step 2:** Remove the 1/2" bolt and nut from the top of the outer tub clamping band.
- Step 3:** Install Dexter Tool part # 8545-056-001 on the back of the outer tub to adjust tub front to cylinder clearance. Thread 5/8" bolt through tool and into cylinder shaft. Push the outer tub forward 1/4" to 1/2" with tool 8545-056-001 by tightening the 5/8" bolt. This will ease the installation of the outer tub front.
- Step 4:** Clean the silicone rubber off the tub front and the outer tub.
- Step 5:** Install new bead of silicone rubber on tub front.
- Step 6:** Install tub front.
- Step 6A:** Align hole in top of tub front with notch in top of outer tub.
- Step 6B:** Use 4-6 #11R vise grip clamps to hold tub front to outer tub. A rubber mallet may be needed to properly seat the tub front into the outer tub.
- Step 6C:** Install tub front gasket around outer edge of tub front and outer tub flange. The opening should be centered at the top.
- Step 6D:** Remove vise grips. The tub front gasket will hold the tub front in place.
- Step 7:** Install tub front clamp ring and tighten. Tap around the clamp ring with a rubber mallet to seat the ring and gasket while tightening the clamp ring bolt.
- Step 8:** Adjust clearance between the outer tub front and the front lip of the cylinder to 5/16".
- Step 9:** Tighten the outer tub clamping band.
- Step 10:** If necessary, the outer tub may be adjusted up or down and side to side with the 2 bolts that fasten the bottom of the outer tub clamping band to the frame.
- Step 11:** Remove Dexter Tool part 8545-056-001 from the back of the outer tub.
- Step 12:** Install drive pulley.
- Step 12A:** Install hub on cylinder shaft.
- Step 12B:** Hold hub against rear bearing with 5/8" bolt and flat washer in end of cylinder shaft.
- Step 12C:** Line up 3 unthreaded holes in pulley with the 3 threaded holes in hub.
- Step 12D:** Insert 3 pulley bolts and tighten evenly alternating bolts to 30ft/lbs.
- NOTE:** Overtightening or uneven tightening can break drive pulley.
- Step 13:** Install drive belts & back panel.
- Step 14:** Install door lock. All mounting holes should be sealed with silicone rubber.
- Step 15:** Install door, masking ring, front panel, lower service panel and top.

T-900, T-1200 Bolt Torque Chart

Bolt Size	Where Used	Torque
7/16" Stainless Cap Screw	Outer Tub to Bearing Housing	60-80 ft/lbs
3/4" Bolt	Bearing Housing to Frame	200-300 ft/lbs
1/2" Bolt	Outer Tub Clamping Band to Frame	70-110 ft/lbs
1/2" Bolt	Outer Tub Clamping Band - Top	30-40 ft/lbs
3/8" Cap Bolt	Driven Pulley to Hub	28-32 ft/lbs



Section 6:

Service Electrical Components

Control Mounting Trough

Remove top panel to access control trough. (see Removing Top Panel) It sets on the right side of the machine and holds the control PCB's, transformers, and pressure switch.

Main Data Communication Cable

Goes between front PCB board and Variable Frequency Drive unit mounted center rear of machine. It has telephone type connectors at each end and is inserted at Controller PCB and the Variable Frequency Drive.

Circuit Breaker/Fuse

The fuse (optional circuit breaker) mounts to the rear channel. It carries all of the controls in the machine but does not include the motor. To reset the circuit breaker just push in the button. If you have a fuse then remove fuseholder and fuse and replace with a 1 1/2 amp fast blow type fuse.

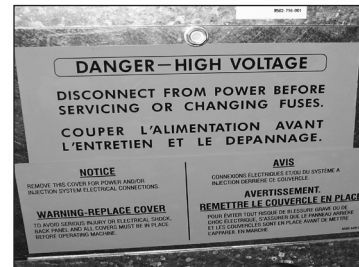

Fuse Location

Main Control Printed Circuit Board

Please be sure to be grounded to machine before removal of this board from machine. PC board mounted vertically behind front control panel. Remove hold down nuts in 4 corners and 1 at bottom center.

PCB Transformer Step-down

Small transformer mounted at front of control trough that is powered with 120 VAC primary and two secondary outputs of 2.3 VAC and 24-27 VAC.

Controls Transformer

This transformer is mounted at the back of the control trough and steps a range of 208 to 240 volts down to 120 volts for the controls. There are two terminals on the controls transformer for incoming power. One terminal tap is marked for 208 volts use this tap for measured voltage of 200 volts - 215 volts. and the other tap is marked 230 volts for 216 volts - 240 volts. Note: All washers have a controls transformer. Always check the incoming voltage and use the appropriate transformer terminal when installing ALL washers.

Main Relay Printed Circuit Board

Please be sure to be grounded to machine before removal of this board. PCB mounting horizontal in control trough towards front of machine. Remove 4 mounting nuts.

LED Printed Circuit Board Temperature & Start Display/Push-Button

The selector switch is mounted in the center of the control panel and is held in place with five nuts. It allows the selection of hot, warm or cold water temperatures. Note: Do not over tighten on reinstallation as the switch can be damaged, stay pushed in and will cause erratic displays.

Add-Bleach LED

This LED light indicates to the user the correct time to add bleach. This LED is polarity sensitive and must be connected correctly.

Pressure Switch Caution (Not recommended by Factory!) Changing Factory preset adjustment voids all factory water usage specifications.

The pressure switch sets the water level in the washer. As the water level rises, it compresses the air in the pressure switch hose. When the washer reaches the desired water level, the compressed air in the pressure switch hose opens the contacts in the switch, shutting off the water. When at the empty level, the pressure switch contacts are closed allowing the machine to either spin or fill with water. The 1/4" screw in the middle of the switch adjusts the water level. Counter clockwise will lower the water level, and clockwise will increase the water level. Before making any adjustments of the pressure switch, drain the tub and blow the hose clear of possible water bubbles which can cause erratic pressure switch operation.

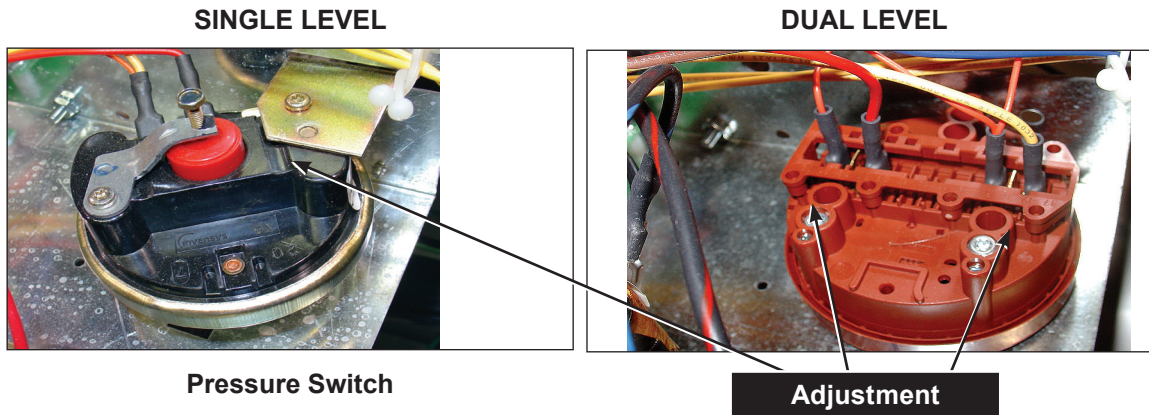

Mechanical Pressure switch VS Pressure Sensor

The Drawing below represents the Mechanical Pressure switch and wiring connections. After serial number W1.15244.001 all washers were converted to the electronic pressure sensor 9732-315-001. If desired previous C-series machines can be upgraded to the electronic pressure sensor with Kit 9732-314-001, Kit includes pressure sensor, hold downs, transformer, and wires. The Electronic pressure sensor wiring configuration is represented in the Diagrams and Schematics in this manual.

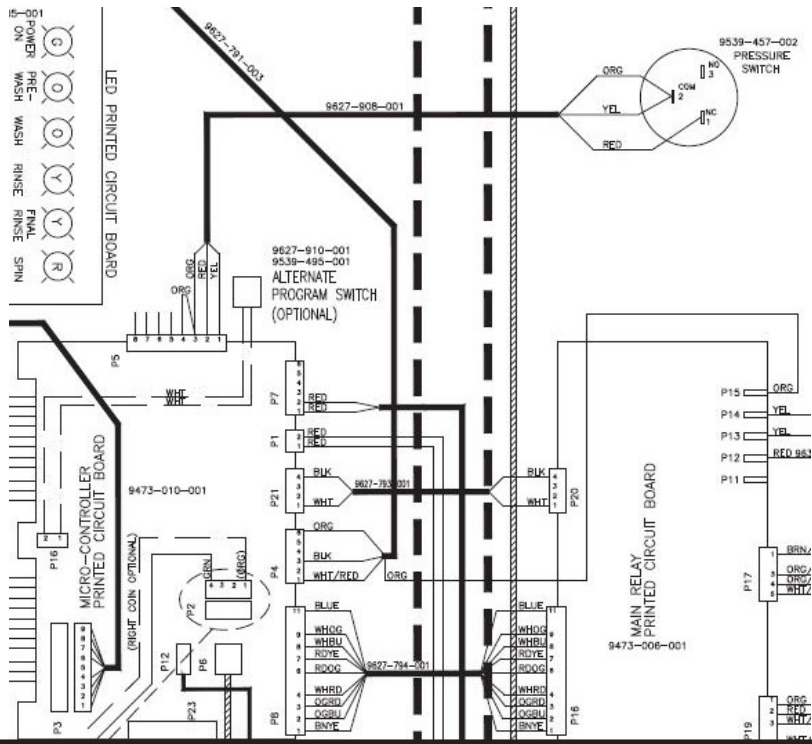

Electronic Pressure Sensor

The Electronic Pressure Sensor comes standard on all models Starting September, 1st 2015. Machines manufactured before this date can be upgraded with Kit 9732-213-001. The Pressure sensor is adjustable. The Factory settings chart will let you know the starting values for each machine and by following the Switch position chart you can adjust the water levels in 1/4 inch increments from that starting value.

Factory Settings:



Model	Vended		On-Premise	
	Switch #1 Efficient	Switch #2 Classic	Switch #1 Low Level	Switch #2 High Level
T-300	5.25	7.00	6.00	6.75
T-350	5.25	6.25	6.00	6.75
T-400	7.00	9.00	8.00	11.00
T-450	6.00	6.25	6.00	8.50
T-450 SWD	5.00	7.00	6.00	8.50
T-600	7.25	9.25	8.00	11.00
T-650	6.50	8.25	8.00	11.00
T-750	6.00	7.50	6.00	8.75
T-900	6.00	7.50	6.00	8.75
T-950	6.00	7.50	6.00	8.75
T-1200	6.00	7.50	6.00	8.75
T-1450	6.75	7.00	6.75	9.50

Switch Positions:

Depth (in):	Pos 1	Pos 2	Pos 3	Pos 4	Pos 5	Pos 6
5.00						
5.25	on					
5.50		on				
5.75	on	on				
6.00			on			
6.25	on		on			
6.50		on	on			
6.75	on	on	on			
7.00				on		
7.25	on			on		
7.50		on		on		
7.75	on	on		on		
8.00			on	on		
8.25	on		on	on		
8.50		on	on	on		
8.75	on	on	on	on		
9.00					on	
9.25	on				on	
9.50		on			on	
9.75	on	on			on	
10.00			on		on	
10.25	on		on		on	
10.50		on	on		on	
10.75	on	on	on		on	
11.00				on	on	
11.25	on			on	on	
11.50		on		on	on	
11.75	on	on		on	on	
12.00			on	on	on	
12.25	on		on	on	on	
12.50		on	on	on	on	
12.75	on	on	on	on	on	
13.00						on
13.25	on					on
13.50		on				on
13.75	on	on				on
14.00			on			on
14.25	on		on			on
14.50		on	on			on
14.75	on	on	on			on
15.00				on		on

Power Connection Terminal Block

This terminal block sets at the very back of the control trough. Incoming power to the washer should connect here. (see Electrical under Installation and Operation Section for exact connections)

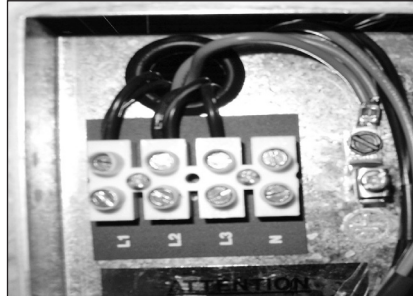

Rear

Delta Variable Frequency Drive:

Main power is connected to terminals L1, L2, and L3 on the Delta drive. If the washer is connected to a three phase source, there should be voltage present on all three terminals. If the washer is connected to single phase power, there should be voltage present on terminals.

The voltage should measure 208 Volts to 240 Volts A.C. between phases and connected to if connected to three phase). There is a tolerance of + 10% on the mains voltage (187 Volts to 264 Volts).

Delta VFD Motor Leads:

The wires from the motor are connected to terminals T1, T2, and T3. Since this drive uses pulse width modulation, an accurate current or voltage reading is not possible. Although an accurate current reading is not possible, a balanced current reading should be present while the motor is running.

Delta VFD Dynamic Braking Resistors:

Two, 160 Ohm or 200 Ohm braking resistors (Please check your washer model parts requirements and quantities), are connected in parallel and attached to the drive at terminals B1 and B2. These resistors allow voltage, which is generated by the motor when decelerating, to be dissipated. They will become hot while the motor is slowing down, so care should be taken so as not to come in contact with them. This will prevent an electrical shock and/or a physical burn.

Delta VFD Cooling Fan:

There is a cooling fan attached to the bottom of the Delta drive. This fan will operate when the internal temperature of the drive reaches a predetermined level, the same way the radiator fan in a newer car operates. THE FAN CAN OPERATE ANYTIME POWER IS APPLIED TO THE DRIVE! Remove power to the drive if work is required around the fan.

MAXIMUM SPIN SPEED ADJUSTMENT:

If desired, the washer can be adjusted to limit the maximum extract spin speed for all wash cycles. To make this adjustment, a jumper wire must either be installed or removed on the Variable Frequency Drive (VFD), depending on the washer model and desired speed. This Dexter jumper part number 8220-057-036 (qty. 1) is factory supplied on terminal points "10V" and "RC". Remove this jumper to make new jumper connections if necessary. Refer to Error! Reference source not found. for the approximate location of the control terminations on the Variable Frequency Drive (VFD) and Error! Reference source not found. for appropriate jumper connection points indicated with an "X" for the desired maximum spin speed setting. If no adjustment to default spin speed is desired, do not remove or add any wires on VFD.

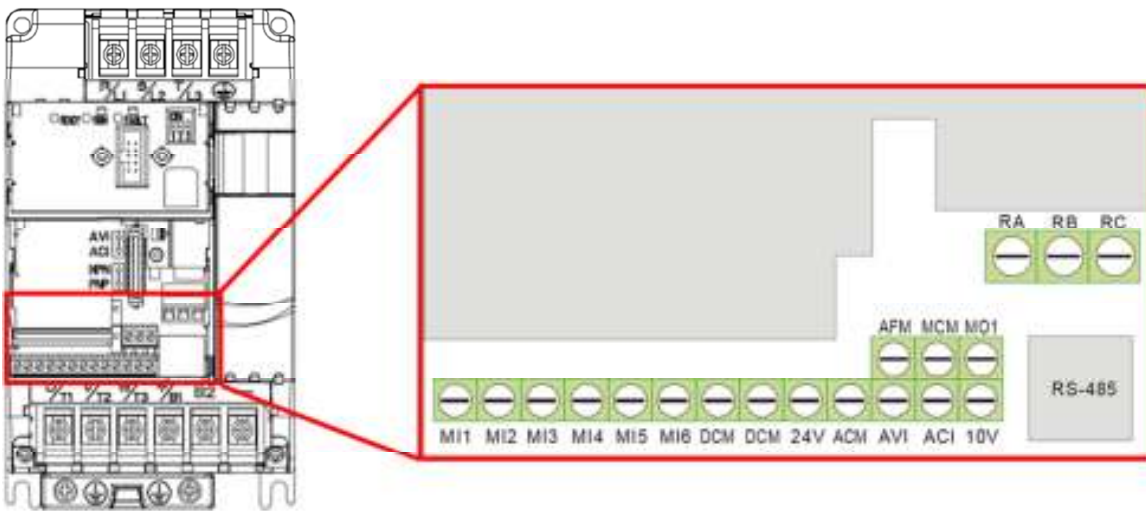

Control Terminations on Variable Frequency Drive

V Series Washer Model	Max Spin Speed	Jumper Terminal Locations on Variable Frequency Drive (VFD)														
		MI1	MI2	MI3	MI4	MI5	MI6	DCM (Left)	DCM (Right)	24V	ACM	AVI	ACI	10V	MO1	
T-300, T-400, T-600, T-900, T-1200	60 G													X		X
	80 G				X			X								
	100 G	Default Setting (No Jumper Required)														
T-350, T-450, T-750	60 G													X		X
	100 G				X			X								
	140 G					X		X								
	200 G	Default Setting (No Jumper Required)														
T-950, T-1450	100 G													X		X
	140 G	REMOVE Brown Jumper between MI5/MO1														
	200 G	Default Setting (With Factory Installed Brown Jumper)														

Spin Speed Adjustment Jumper Locations



Section 7:

Electrical Wiring Diagrams & Schematics

Electrical Path Circuit Schematics

Start Circuit

Power travels into the machine on L1 & L2 & (L3) (if 3 phase used). 208- 240VAC goes to a Control Transformer (must be checked at start -up to coincide with machine operating voltage) that steps the voltage down to 115VAC for the controls. 115VAC then travels from the transformer out on [X-1 red wire to the (fuse)] or [X-1 blk/red wire] to TB-4 then to the red wire to the fuse, (fuse in fuseholder). X-2 Blk/ blu wire is the neutral side of the transformer.

From the Fuse holder, 115VAC travels on the red wire to the #5 terminal on the terminal strip and then on the black wire to the Step-Down Transformer where it is stepped down to 2.3 VAC and 24 VAC that proceeds to the P 7 connection to power the micro-controller PCB. The Door must be closed to satisfy the door closed switch mounted on masking ring at front door. With data going out from front main PCB on the black wire through door closed switch and red wire out of door closed switch and over to door latched switch to await start button being pressed. Main PCB is satisfied and a 5 VDC signal is sent out of P4 connection on the white/red to the S1 door switch. With the S1 door switch closed 5 VDC is now on the red wire at the P4 connector of the micro-controlled PCB and a 115VAC signal will go to the Door Lock Solenoid from the P17 connector of the Main Relay PCB on the white/red wire. The Door Lock Solenoid pulls in, locking the door and closing the S2 and S3 Switches. The S2 Switch is a backup to the S1 Switch so that the adjustment on S1 isn't as critical. The S3 Switch provides 5 VDC on the org. wire back to P4 connector at micro-controlled PCB and P15 connector at the main relay PCB to know the loading door is closed and locked. Org. wire @ P15 turns on the enable to the drive to allow motion. With no signal on P15 (org. wire) there will be no motion of the tub. The black wire and white wire between Front controller PCB P21 and the main relay PCB P 20 is where door lock data is supplied to indicate door closed and locked to relay PCB and allows 120 volts to pass through relays to drain valve and water valves. The blue wire from the terminal strip will provide the 115 VAC neutral for solenoid, thermoactuators and all valves and the white wire from the terminal to the step down transformer.

Fill Circuit-Warm

S1, S2, and S3 Door Switches are now closed . The green On LED and the Door Lock Solenoid (discussed in Start Circuit) will remain on throughout the cycle. The Lock Thermoactuator receives 115VAC on orange/blue from P17 on main relay PCB and will alternate open and closed keeping the Lock Thermoactuator activated until 1 1/2 minutes before the end of the cycle. At this point the contact opens and removes power to the Lock Thermoactuator. The micro-controlled PCB also sends a signal to the main relay PCB and out through P17. The brown/yellow wire from P17 at main relay PCB supplies 115VAC to Drain valve which closes the valve. The reversing operation which will alternately provide the direction of tumble for the wash basket will be given commands to the VFD through the data cables at P6 micro-controlled PCB. The Prewash or Wash LED will illuminate at this time powered through the white wires from the micro-control PCB P3 to LED printed circuit board.

Now with a cycle previously; we'll use Normal Wash; the washer fills the tub through the back of the machine with either one or both the C1 Cold and H1 Hot Water Valves. At the beginning of the wash cycle bath only after a 90 sec. delay, the detergent dispenser flushes the detergent into the tub for 20 sec.. This is accomplished when 120VAC travels through the red/orange wire to the H2 Hot Water Valve Solenoid. As the washer fills with water, the Wash Basket will tumble one direction for 12 seconds, pause, and then reverse direction for 12 seconds. 120VAC goes through the P19 connection of main relay PCB on wht/ brn to the C1 cold water valve and the red/yellow wire to the H1 hot water valve if programmed. When the water reaches the predetermined level the Pressure Switch moves switch contacts to the full position and shuts voltage off to the both water valves. Between red wire from P5 micro-controlled PCB on pressure switch contact and yellow and orange wire from P5 micro-controlled PCB at other pressure switch contact a 5 VDC reading will open.

Wash Circuit

As the washer fills the tub through the back of the machine with either one or both the C1 Cold and H1 Hot Water Valves, the Wash Basket will tumble one direction for 12 seconds, pause, and then reverse direction for 12 seconds. This is accomplished through the use of a variable frequency drive. The time of the bath is programmable up 15 minutes per bath used.

Drain, Rinse 1 - 4, & Final Rinse Circuit

When the bath ends the micro-controller PCB removes 115 VAC power from brn/yel coming from main relay PCB at P17 to the Drain Valve. The normally-open spring-loaded Drain Valve opens and empties the tub. For Rinse 1 & 2, the Rinse LED will illuminate. The rinse water temperatures are programmable and will fill as above. For the Final Rinse, the Final Rinse LED will illuminate. These water temperatures are programmable also and will fill as described above. Also the softener dispenser will flush cold water from C2 cold water valve solenoid at beginning of final rinse bath for 20 sec..

Extract Circuit

The Spin LED will illuminate and the washer controller PCB sends a signal to the Variable frequency drive via the data cable at P6 to VFD RJ-11. The rotation as viewed from front during spin will be CCW except for the 18 lb washer it will spin CW. The motor is a 3 phase 230 VAC type motor for all models .

Thermoactuator and Shake Out Circuit

The Lock Thermoactuator loses power and opens 1 1/2 minutes before the end of the cycle . This allows the Thermoactuator time to retract by the end of the cycle. To insure that the Lock Thermoactuator has retracted by the end of the cycle, 1 minute prior to the end of the cycle, the Unlock Thermoactuator is powered with 115VAC through the org/red wire from P17 at main relay PCB. The basket will come to a stop from extract speed with the assistance of dynamic braking resistors wired in parallel to the variable frequency drive. The washer will then tumble for 45 seconds to let the clothes shake loose and then stop.

End of Cycle Circuit

The machine is now stopped and does 2 things: 1. The beeper will signal for 5 seconds letting the user know that it is the end of the cycle. 2. The micro-controlled PCB resets and display will reset when door is opened and it is now ready to run again.

Bath	Bath Cycle Time (min.)	Water Temp.	Water Level	Delay Fill	Spin Time (min.)	Injection Source
Flush	3	CH	HI	d		
Prewash	2	CH	HI	d		
Wash	7	HH	LO	d	1	#1(Detergent)
Rinse 1	7	HH	LO	d	2	#2 (Bleach)
Rinse 2	2	CH	HI	d	1	
Rinse 3	2	CH	HI	d		
Rinse 4						
Final Rinse	4	CH	LO	d	4	#4 (Sour/Soft)

WN1200XA-12 Schematic

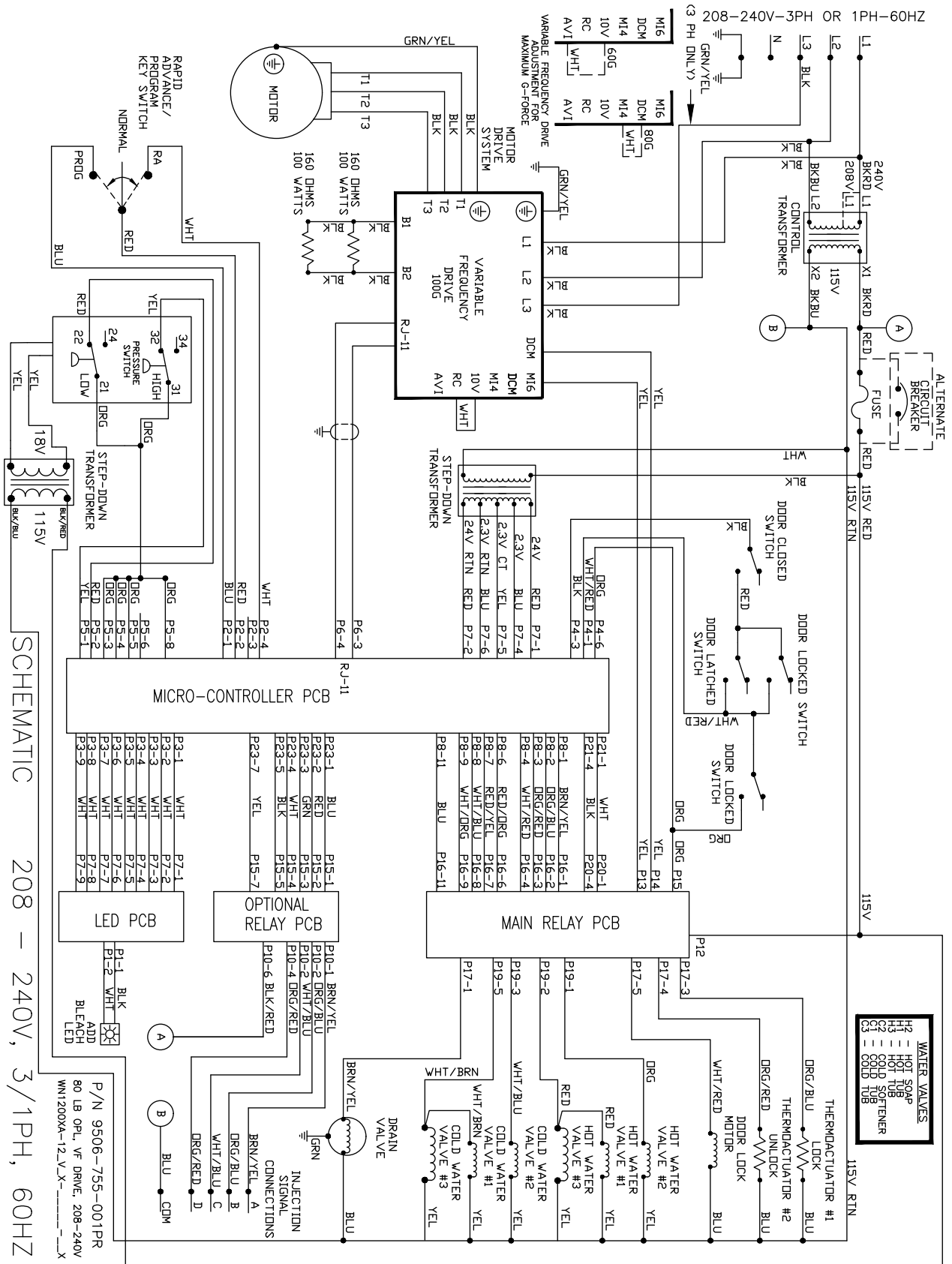



Section 8:

Parts Data

WN0750XA-12EV	208-240 volts	60hz.	Single Phase or Three Phase
WN0900XA-12EV	208-240 volts	60hz	Single Phase or Three Phase
WN0950XA-12EV	208-240 volts	60hz	Single Phase or Three Phase
WN1200XA-12EV	208-240-volts	60hz	Single Phase or Three Phase
WN1450XA-12EV	208-240 volts	60 hz	Single Phase or Three Phase

C-Series OPL Accessories

WN0750XA-12EV	208-240 volts	60hz.	Single Phase or Three Phase
WN0900XA-12EV	208-240 volts	60hz	Single Phase or Three Phase
WN0950XA-12EV	208-240 volts	60hz	Single Phase or Three Phase
WN1200XA-12EV	208-240-volts	60hz	Single Phase or Three Phase
WN1450XA-12EV	208-240 volts	60 Hz	Single Phase or Three Phase

Key	Description	T900	T1200	QTY
*	Hose, Water Supply 5/8" I.D. x 48"	9990-027-013		2
	Hose, Water Supply 5/8" I.D. x 48"		9990-027-013	4
*	Washer, Inlet Hose (furnished)	8641-242-000	8641-242-000	2
*	Strainer, Inlet Hose (furnished)	9565-003-001	9565-003-001	2
*	Bevel Washer for 5/8" bolt used in installations using angle iron bases	8641-586-002	8641-586-002	
*	Bevel Washer for 3/4" bolt used in installations using angle iron bases	8641-586-003	8641-586-003	4
*	Sealing compound RTV-45	8538-151-002	8538-151-002	1
*	Flow Restrictors (in dispenser)	9475-002-002	9475-002-003	2
*	Battery (used on Control PCB)	8612-001-001	8612-001-001	1
*	Clamps to hold tub front to outer tub when installing tub front	Vise Grip #11R	Vise Grip #11R	1
*	OPL Bearing & Seal Kit	9732-219-007	9732-219-007	1
*	OPL Op CD with OS2 Platform for V Series Washer Controls	9504-016-001	9504-016-001	1
	Palm Pilot Zire 31	9150-035-001	9150-035-001	1
	Key Service Lock (6324)	6292-006-007	6292-006-007	1
	Key, Program (N561)	6292-006-013	6292-006-013	1
	USB Thumb Drive W/Opreator Booklets all sizes	9150-045-002	9150-045-002	

Wiring Harness Part # by Model

Key	Description	T900	T1200	QTY
*	Wiring Harness (Add Bleach Lite assy included)	9794-001-001	9794-001-001	1
*	Wiring Harness, Door Lock	9627-791-005	9627-791-005	1
*	Wiring Harness, Drain,Thermo,DoorSol	9627-796-002	9627-796-002	1
*	Data Cable	9806-015-001	9806-015-003	1
*	Wiring Harness P20/P21	9627-793-001	9627-793-001	1
*	Wiring Harness P8/P16	9627-794-001	9627-794-001	1
*	Wiring Harness WaterValve/P19	9627-795-004	9627-795-004	1
*	Wiring Harness LED PCB	9627-797-001	9627-797-001	1
*	Wiring Harness P5/pressure	9627-807-001	9627-807-001	1
*	Wiring Assembly Yel. 32"	8220-064-023		2
*	Wiring Assembly Yel. 64"		8220-064-040	2
*	Wiring Assembly Red 41"		8220-062-032	2
*	Wiring Assembly Vio. 24"		8220-118-001	2
*	Wiring Assembly Wht/Brn 8"		8220-108-007	1
*	Wiring Assembly Jumper Yel	8220-123-001	8220-128-001	1
*	Wire Red Yellow 8"		8220-108-008	1
*	Wire Yellow Jumper (water valve)		8220-119-002	1
*	80lb Washer Dispenser Label		8502-687-001	1
*	Wiring Assembly Red 28" #24	8220-062-025		2
*	Wiring Assembly Blk. 17"	8220-062-028	8220-062-028	1
*	Wiring Assembly Red 17"	8220-062-027	8220-062-027	1
*	Wiring Assembly Jumper BLK.	8220-117-002	8220-117-003	2
*	Wiring Assembly Red 7" #36	9631-381-018	9631-381-018	1
*	Wiring Assembly Blu/Wht	8220-090-009	8220-090-009	1
*	Wiring Assembly Blk/Blu	8220-001-231	8220-001-231	1
*	Wire Assembly Green 7"			1
*	Wire Assembly BLK. 23" #8			
*	Harness Power Terminal Block	9627-747-002	9627-747-002	1

Cabinet and Front Panel Group Part # by Model

Large Door

Key	Description	T900	T1200	QTY
1	Panel, Side (Left or Right) - stainless	9454-839-001	9454-814-001	4
*	Bolt-1/4-20x1/2 (side panel Front to Rear)	9545-018-013	9545-018-013	8
	Nut 1/4-20UNC (side panel)	8640-414-006	8640-414-006	8
	Strap Assy (Side to base)	9966-012-001	9966-012-002	4
*	Shim (side panel)	9552-039-001	9552-042-001	2
*	Nut, Hex 1/4-20 UNC	8640-414-006	8640-414-006	8
2	Bracket, Side Panel under front panel	9046-085-001	9046-085-001	1
*	Screw #10Bx1/2 side panel brkt	9545-008-026	9545-008-026	1
*	Nut 1/4-20 UNC side panel brkt	8640-414-006	8640-414-006	1
•	Nut, Hex	8640-413-002	8640-413-002	2
*	Screw	9545-008-024	9545-008-024	2
3	Panel Assy, Front	9454-840-002	9454-811-002	1
4	Band, Edge Protector	9578-092-002	9578-092-002	1
*	Bumper Loading Door	9051-055-001	9051-055-001	1
*	Nut, 1/4 x 20 for bumper	8640-414-006	8640-414-006	1
*	Screw, Hex- To Control Panel	9545-008-024	9545-008-024	2
*	Nut, Spring- To Control Panel 10/32	8640-399-003	8640-399-003	2
5	Screw, Flat Head- Front to Sides	9545-008-014	9545-008-014	2
6	Washer, Finish	8641-585-001	8641-585-001	2
*	Nut, Spring-To Front Panel	8640-399-008	8640-399-008	2
7	Label, Door Opening (Black)	8502-757-001	8502-757-001	1
8	Panel, Control (Mounts Nameplate)	9989-480-001	9989-456-001	1
*	Screw, Control Panel to Sides	9545-008-026	9545-008-026	4
9	Nameplate Decal, Control Black	9412-224-001	9412-229-001	
10	Panel Top	9454-736-001		1
11A	Panel Top Front		9454-761-001	1
11B	Panel Top Rear		9454-762-001	1
12	Lock, Top (w/Key)	8650-012-003	8650-012-003	2
13	Door, Lower Service, Includes Handle	9960-286-004	9960-286-004	1
14	Handle (bumper guard)	9244-086-003	9244-086-003	1
*	Rivet Blind 3/16" Alum	9491-009-003	9491-009-003	4
*	Screw	9545-045-010	9545-045-010	4

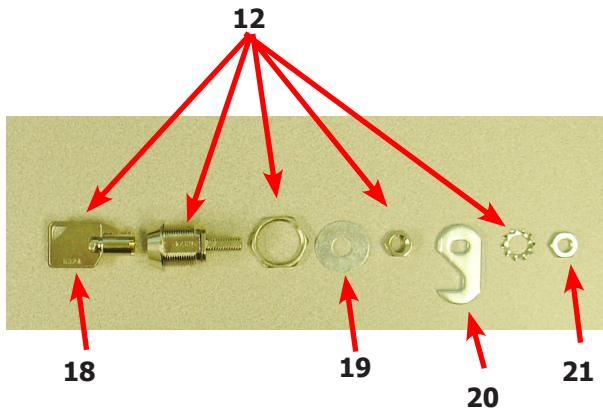
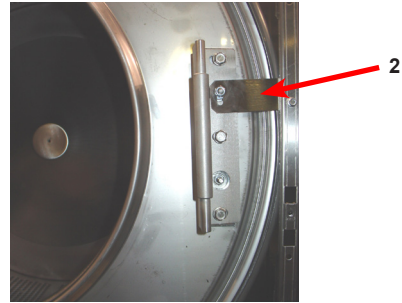

Key	Description	T900	T1200	QTY
15	Screw Mtg., Flat Head 10Bx1 3/4	9545-008-014	9545-008-014	2
16	Washer, Finish	8641-585-001	8641-585-001	2
*	Nut, Spring	8640-399-008	8640-399-008	2
17	Label-Risk of injury (Black)	8507-759-001	8507-759-001	1
18	Key, Top- # 6324	6292-006-007	6292-006-007	
19	Washer Flat 5/16	8641-581-008	8641-581-008	2
20	Cam, Lock-Top	9095-049-001	9095-049-001	2
21	Nut, 9/32 - 28 Hex	8640-426-001	8640-426-001	2

Cabinet and Front Panel Group Part # by Model

Front Soap Dish

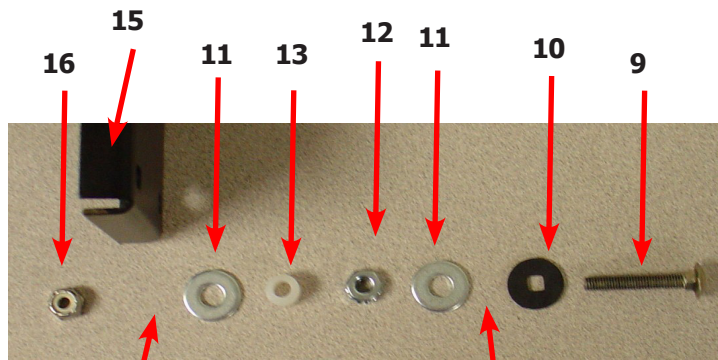
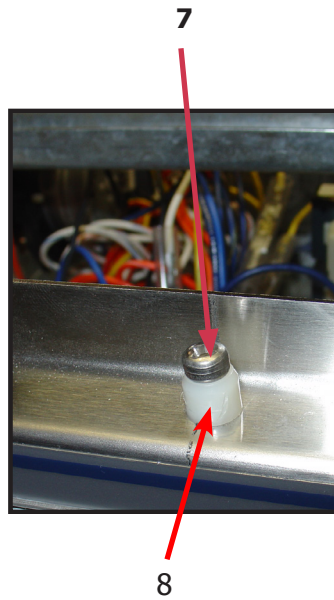
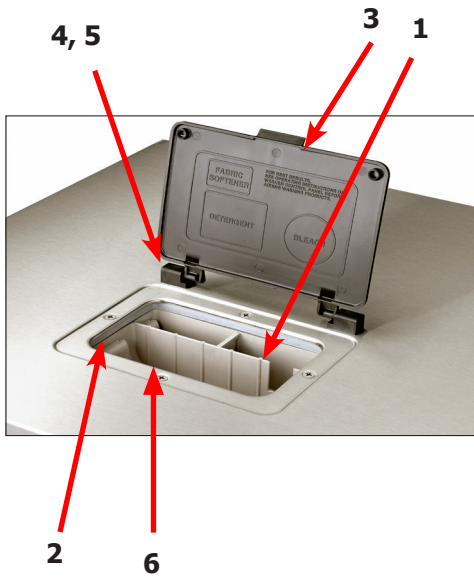

Gasket and Soap Dish Here

Tub Front Here

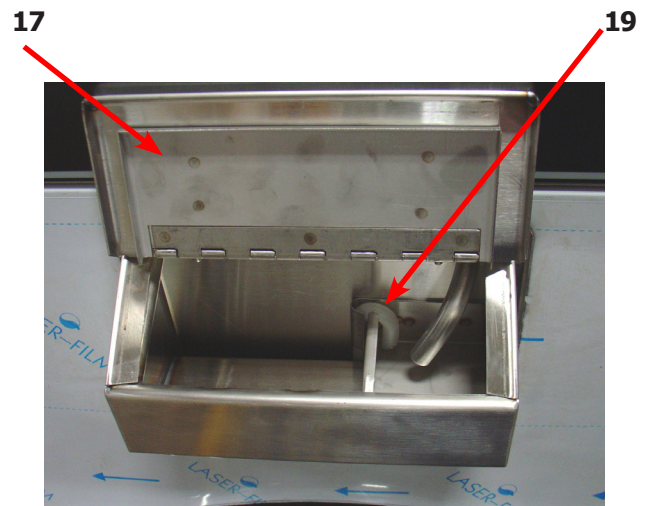
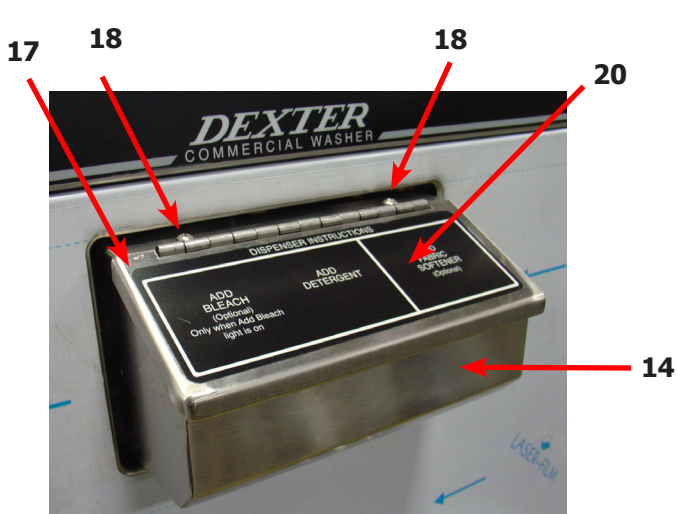

Top Mount Detergent Dispenser

Key	Description	T900	T1200	QTY
1	Dispenser Soap	9122-005-004		1
2	Gasket Dispensor	9206-416-001		1
*	Hose, Dispensor to tub	9242-450-001		1
*	Clamp	8654-117-008		2
*	Nut, Spring ss	8640-399-007		4
*	Flow restrictors	9475-002-002		2
*	Flow restrictors Optional (Smaller)	9475-002-003		2
3	Door, Dispenser	9108-095-005		1
4	Pin, Plain	9451-191-001		2
*	Post, Door Mounting	9467-025-001		2
6	Screw- 8B x 1/2	9545-045-002		4
	Screw, SS Dispenser, 10B x 1	9545-008-012		4
*	Washer Flat 5/16	8641-581-008	8641-581-008	1
7	Screw, Locator	9545-008-023	9545-008-023	1
8	Plastic Sleeve, Locator	9355-001-001	9355-001-001	1
*	Catch, Top Panel	9086-017-001	9086-017-001	2
*	Lock, Top (w/Key)	8650-012-003	8650-012-003	2

Front Mount Detergent Dispenser

Key	Description	T900	T1200	QTY
9	Bolt, #10-32 x 1 1/4"SS		9545-012-026	6
10	Special Washer, Rubber		8641-222-000	6
*	Tub Front			1
11	Washer-Flat, 1/4		8641-581-018	12
12	Nut, #10-32UNF		8640-413-002	6
13	Spacer Plastic #10x1/2		9538-157-019	6
14	Soap Dispenser (no lid)		9807-087-001	1
*	Det. Dispenser Mtg Gasket to Tub frnt		9206-425-001	1
15	Bracket Soap box mounting		9029-122-002	1
16	Nut Hex Elasticstop #10-32 SS mtg dispenser		8640-413-006	6
17	Lid Assembly dispenser		9987-104-001	1
18	Lid screws #10-32x1/2 SS		9545-012-017	2
19	Softner siphon tube (plastic)		9574-252-002	1
*	Flow restrictors		9475-002-003	AR
20	Washer Dispenser Label Black		8502-756-001	1
*	Kit-Soap Dish, Replacement (Large Door)		9732-290-001	

Rear View Access Part # by Model

Key	Description	T900	T1200	QTY
1	Drive Motor, 3 Phase (Inverter duty)	9376-308-001	9376-329-001	1
2	Rod, Motor Mtg	9497-222-004	9497-222-004	1
*	Collar, Shaft (w/set screws) (old)	9076-052-002	9076-052-002	2
*	Motor Bushing (plastic)	9053-074-002	9053-074-002	1
3	New motor bushing support	9053-082-001	9053-082-001	2
4	Clamp for motor bushing	8654-117-019	8654-117-019	2
5	Pulley, Motor	9453-175-002	9453-175-002	1
*	Split TaperBushing (motor pulley)	9053-077-001	9053-077-001	2
*	Screw taper bushing 1/4-20x1	9545-018-024	9545-018-024	3
6	Bolt, Eye (1/4"-20x1/2")	9545-055-001	9545-055-001	1
*	Nut, 1/4 Elastic Stop	8640-414-003	8640-414-003	1
*	Link (open end)	9341-046-001	9341-046-001	1
7	Chain (Spring Tension)	9099-012-003	9099-012-004	1
8	Spring, Belt Tension	9534-151-000	9534-151-000	1
9	Pulley, Driven	9453-176-005	9453-176-005	1
10	Bolt, 3/8"-16 x 2"	9545-029-011	9545-029-011	3
11	Washer, 3/8"	8641-582-003	8641-582-003	3
*	Bushing Taperlock (Driven)	9053-078-002	9053-078-002	1
12	Washer-Flat .675x2-1/2x1/4	8641-581-043	8641-581-043	1
13	Lockwasher-Exttooth, 5/8	8641-582-018	8641-582-018	1
14	Bolt, 5/8-11x1 1/2	9545-060-001	9545-060-001	1
15	Drive Belt	9040-079-002	9040-079-003	1
*	Panel Assy., Back	9989-526-001	9545-766-001	1
*	Screw Panel Mtg.#10Bx1/2"		9545-008-026	
*	Screw Panel Mtg.#10Bx1/2"	9545-008-026		
*	Nut, Spring	8640-399-008	8640-399-008	AR
*	Screw, To Base-1/4" x 3/4"	9545-030-002	9545-030-002	3

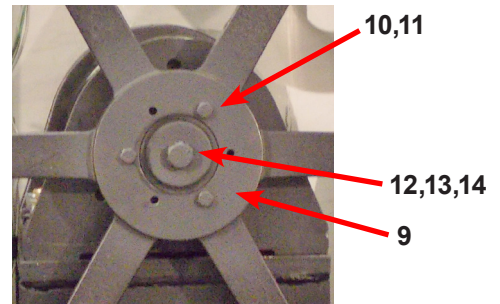
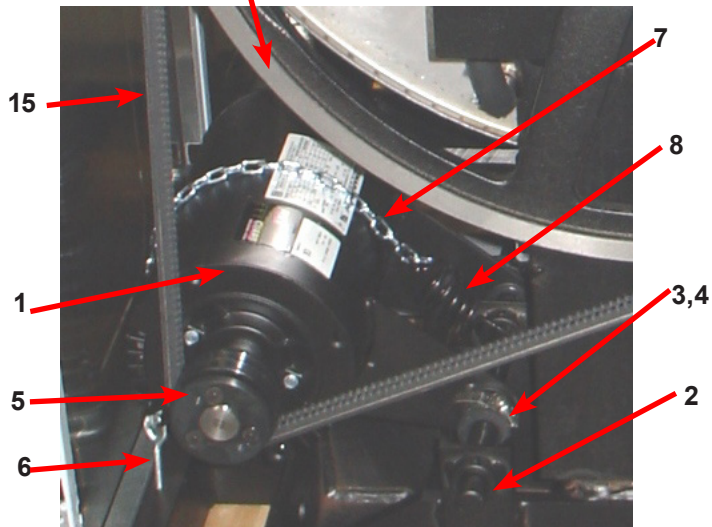
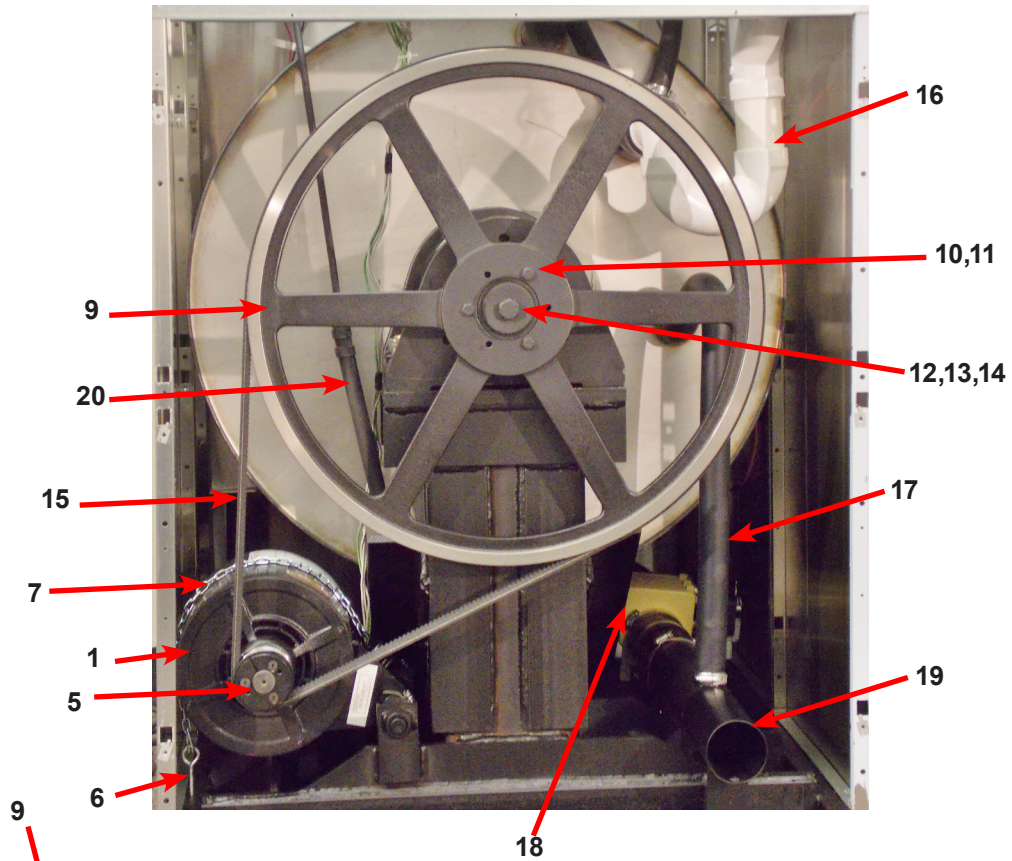

Key	Description	T900	T1200	QTY
16	Injection- tube assy	9883-012-001	9883-012-001	1
*	Hose, Injection Tube to Tub	9242-461-001	9242-461-001	1
*	Clamp, Injection Hose	8654-117-014	8654-117-014	2
17	Hose-Overflow	9242-449-003	9242-449-003	1
*	Clamp Hose Over Flow	8654-117-008	8654-117-008	2
18	Drain Valve	9379-200-001	9379-200-001	1
*	Hose, Drain Valve to Tube	9242-457-001	9242-457-001	1
*	Clamp	8654-117-014	8654-117-014	2
19	Drain Tube	9915-120-004	9915-126-002	1
20	Hose-Pressure Switch	9242-175-007	9242-175-004	1

Key	Description	T900	T1200	QTY
1	Channel, Rear	9081-169-001	9081-169-001	1
2	Screw #10Bx1/2	9545-008-026	9545-008-026	4
*	Nut, Spring	8640-399-008	8640-399-008	4
3	Plug, 7/8"	9456-041-006	9456-041-006	1
4	Bushing, 7/8"	9053-067-002	9053-067-002	1
5	Braacket-Terminal Block Assy	9029-265-001	9029-265-001	1
6	Screw, 10Bx1/2	9545-008-026	9545-008-026	4
7	Strip-Terminal marker, Power	9558-025-001	9558-025-001	1
8	Terminal Block-Power	9897-033-002	9897-033-002	1
*	Screw-6ABx3/4	9545-031-010	9545-031-010	2
9	Harness-Power Terminal Block	9627-747-003	9627-747-003	1
10	Terrminal Lug, Solderless	8652-134-001	8652-134-001	1
*	Lockwasher-Exttooth, #10	8641-582-006	8641-582-006	1
*	Screw-10-32ttX1x1/2Grn	9545-008-027	9545-008-027	2
11	Strip-Terminal Marking, Injector	9558-028-001	9558-028-001	1
12	Terminal Block-Injector	9897-032-002	9897-032-002	1
*	Screw-4Bx5/8ss	9545-053-002	9545-053-002	2
13	Harness-Injection	9627-799-001	9627-799-003	1
14	Label-Warning	8502-639-001	8502-639-001	1
15	Bushing-Insulated, 3/4"	9053-067-001	9053-067-001	1
16	Bushing-Insulated, 1"	9053-067-004	9053-067-004	1
*	Cover, Terminal Block	9074-267-001	9074-267-001	1
*	Screw #10Bx1/2	9545-008-026	9545-008-026	1
17	Plate-Drive mounting	9982-383-001	9982-383-001	1
18	Nut, #10-32UNF, 2B	8460-413-002	8460-413-002	4
19	VFD Delta "E" drive 208-240 volt	9375-028-015	9375-028-013	1
20	Nut, #10-32UNF, 2B	8460-413-002	8460-413-002	4
*	Cable, Data	9806-015-001	9806-015-003	1
*	Clamp, Cable	8654-125-005	8654-125-005	1
21	Plate-Water Valves, Mounting	9452-814-001	9452-814-001	1
22	Nut, #10-32UNF, 2B	8460-413-002	8460-413-002	4
23	Valve-Water, Duel Coil	9379-183-012	9379-183-012	2
24	Screw #10Bx1/2	9545-008-026	9545-008-026	4
*	Plate-Cover, Water Valves	9452-794-001		1
*	Screw, 10Bx1/2	9545-008-026		2
25	Water-Valve, Single Coil		9379-194-001	2
26	Screw-Phillips, 4mx0.7x8mm		9545-064-001	4
27	Shield, Water Valves	9550-195-001	9550-195-001	1
28	Clip-Push	9083-121-001	9083-121-001	4
29	Cap-Injector Assy	0935-127-001	0935-127-001	1
30	Clamp	8654-117-014	8654-117-014	1
31	Hose-Suds Overflow	9242-463-004	9242-463-004	1
32	Resistors (160 Ohm)	9483-004-003	9483-004-003	2
33	Screws #10-32x1/2" (Mounting)	9545-012-008	9545-012-008	4
34	Jumper Wires	8220-117-002	8220-117-002	2

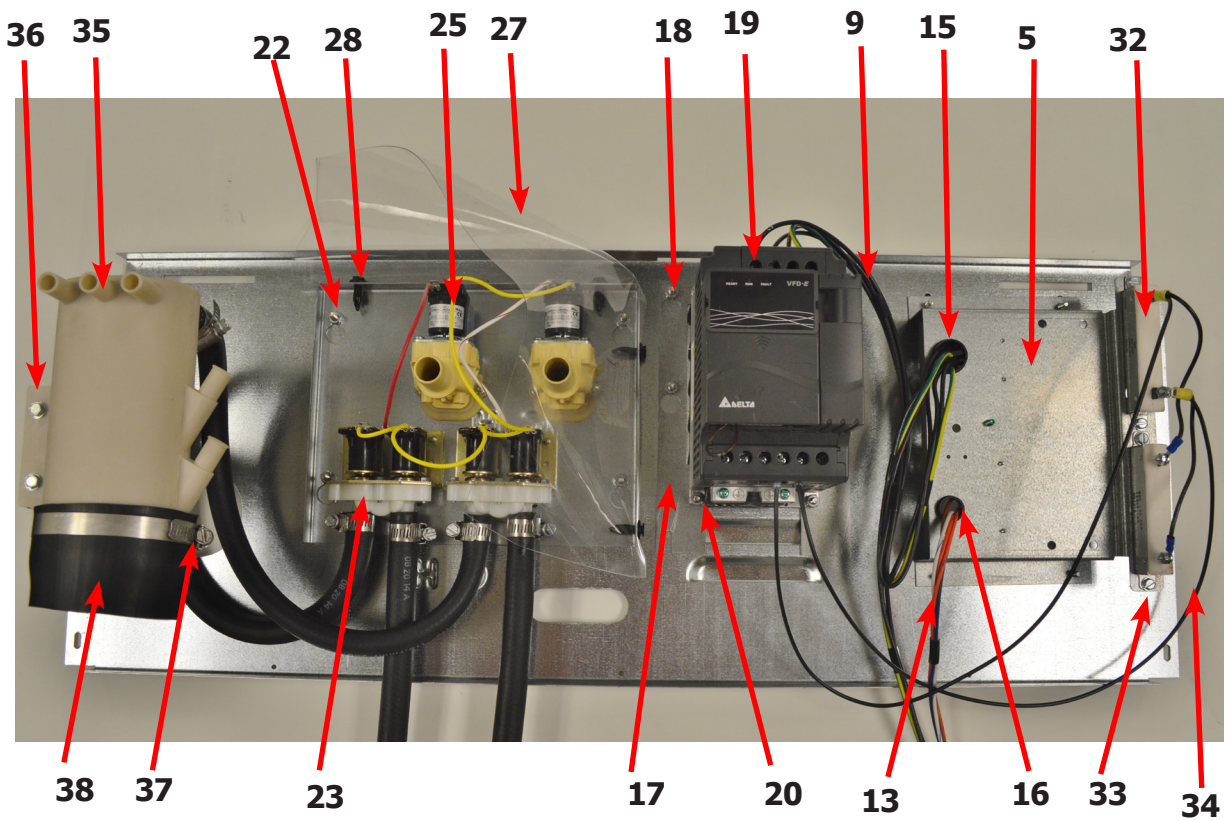
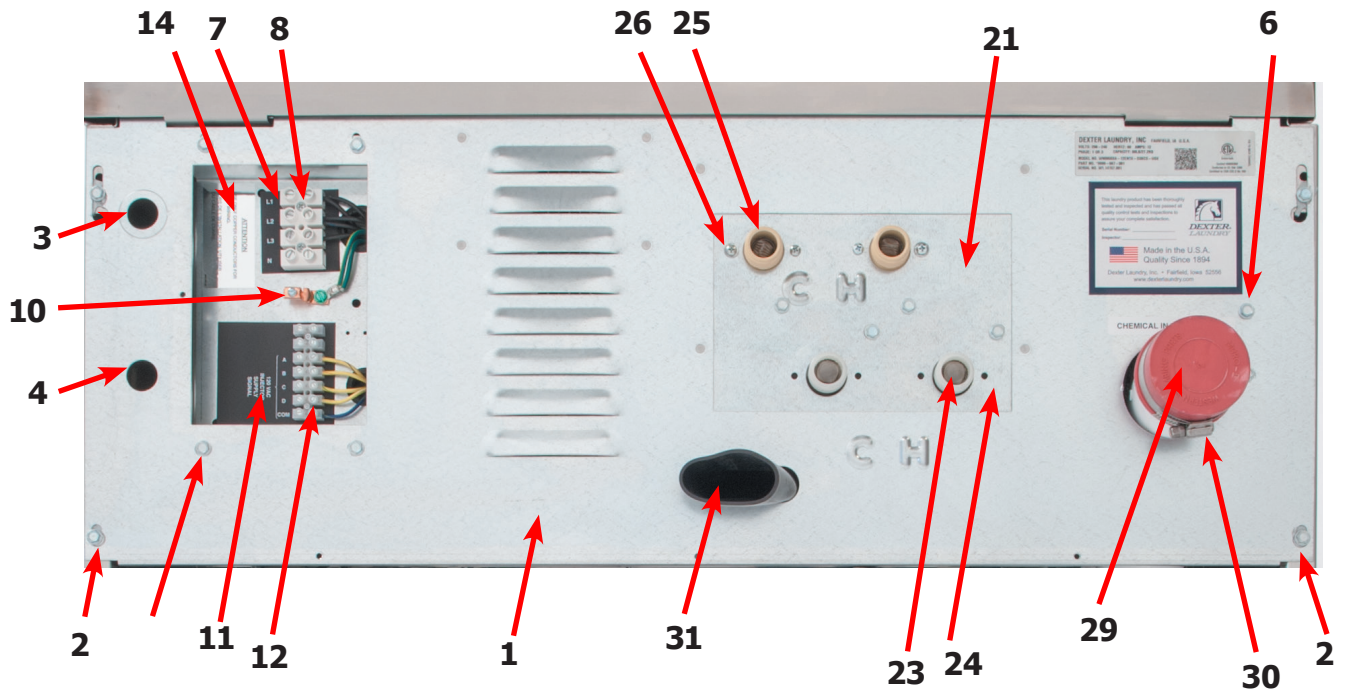

Key	Description	T900	T1200	QTY
35	Vacuum Breaker	9610-001-001	9610-001-001	1
*	Bracket-Vacume Breaker	9029-077-001	9029-077-001	1
36	Screw, 10Bx1/2	9545-008-026	9545-008-026	4
37	Clamp, Vacuum Breaker End	8654-117-014	8654-117-014	1
38	Hose, Vacuum Breaker to Tub Injection Tube	9242-461-001	9242-461-001	1

Cylinder, Seals & Bearings Part # by Model

Key	Description	T900	T1200	QTY
1	Housing, Bearing- Assembly (items #2-#6)	9803-187-001	9803-187-001	1
2	Housing, Bearing	9241-181-004	9241-181-004	1
3	Bearing, Front (LARGE)	9036-159-006	9036-159-006	1
4	Bearing, Rear (SMALL)	9036-159-005	9036-159-005	1
5	Spacer, Bearing	9538-170-001	9538-170-001	1
6	Ring, Bearing Retainer	9487-238-004	9487-238-004	1
7	Tub Assembly	9930-157-001	9930-154-001	1
8	Seal, Primary V85A	9532-140-007	9532-140-007	1
9	Seal, Secondary V140A	9532-140-008	9532-140-008	1
10	Ring, Seal Mounting	9950-052-001	9950-052-001	1
11	Tub Back Mating Ring	9487-266-001	9487-266-001	1
11G	Mating Ring Guard Shield	9487-261-004	9487-261-004	1
12	Bolt, Tub End of Bearing Housing (7/16-14x1), Bolt from inside Tub	9545-059-004	9545-059-004	6
13	Washer, Flat	8641-581-034	8641-581-034	6
14	Screw-Hex Cap, 3/4"-10 x 3" (Bearing Housing to Frame)	9545-057-002	9545-057-002	6
15	Washers Spherical 3/4 (Male half) (Bearing Housing to Frame)	8641-588-001	8641-588-001	6
16	Washers Spherical 3/4 (Female half) (Bearing Housing to Frame)	8641-588-002	8641-588-002	6
15	Washer, Flat	8641-581-034		6
16	Lock Washer-Extrenal Tooth, 3/4" (Bearing Housing to Frame)	8641-582-020		6
17	Nut 3/4"-10 (Bearing Housing to Frame)	8640-418-003	8640-418-003	6
18	Pulley, Driven	9453-176-005	9453-176-005	1
19	Bolt, 3/8"-16 x 2"	9545-029-011	9545-029-011	3
20	Washer, 3/8"	8641-582-003	8641-582-003	3
21	Bushing Taperlock (Driven & Large)	9053-078-002	9053-078-002	1
22	Washer-Flat .675x2-1/2x1/4	8641-581-043	8641-581-043	1
23	Lockwasher-Exttooth, 5/8	8641-582-018	8641-582-018	1
24	Bolt, 5/8-11x1 1/2	9545-060-001	9545-060-001	1
25	Tub & Cylinder Assy	9869-027-003	9869-022-003	1

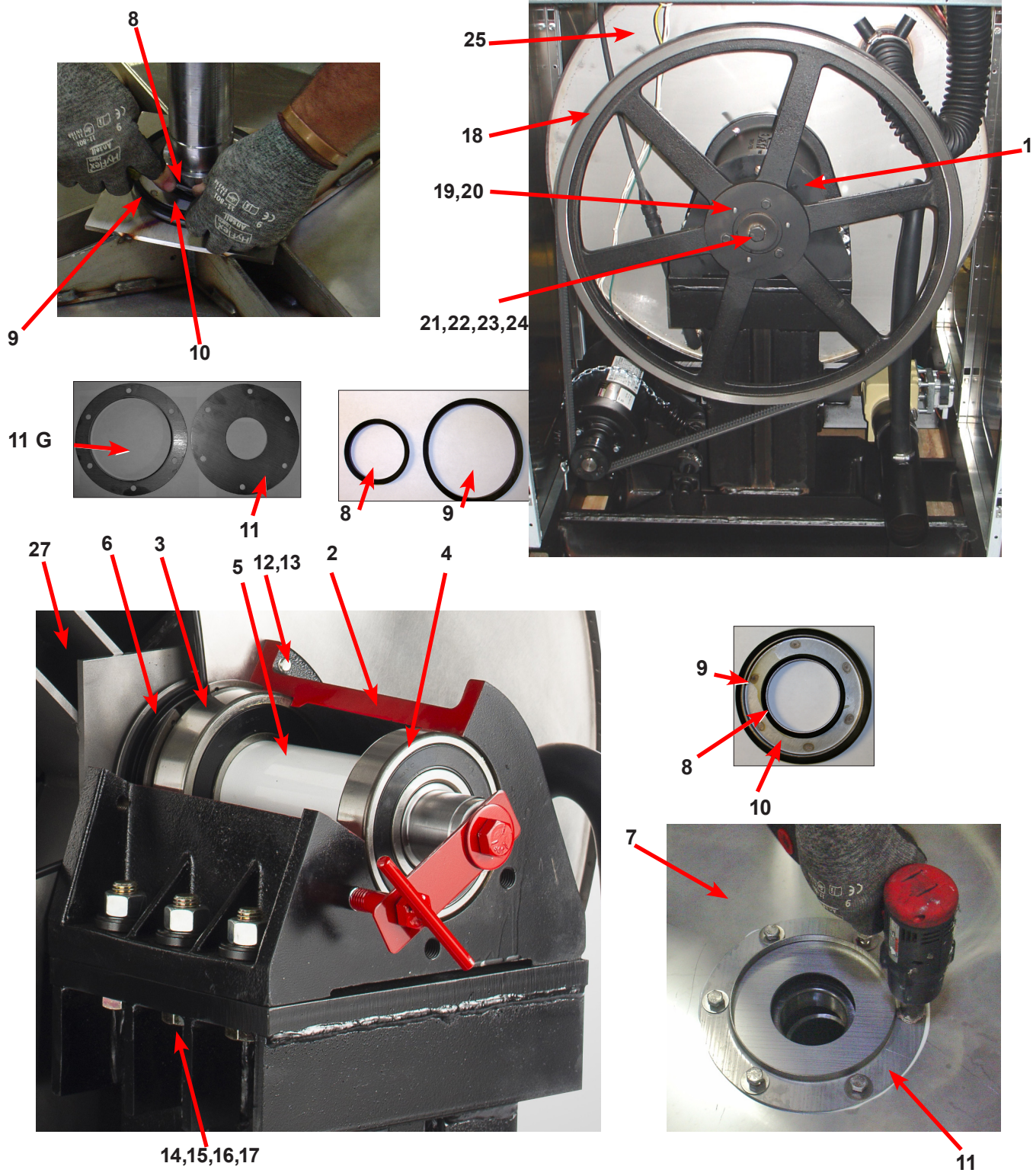

Key	Description	T-900	T1200	QTY
27	Cylinder Assy	9848-136-001	9848-137-002	
*	Tub Front	9974-011-001	9974-011-002	1
*	Gasket, Tub Front	9206-421-002	9206-421-002	1
*	Ring Assy, Tub Mtg-Front Clamp	9950-055-001	9950-055-001	1
*	Bolt, Top Front Ring 3/8"-16 x 3"	9545-029-009	9545-029-009	1
*	Nut WCAD 3/8"-16	8640-415-001	8640-415-001	1

Door Lock Assembly (All Models)

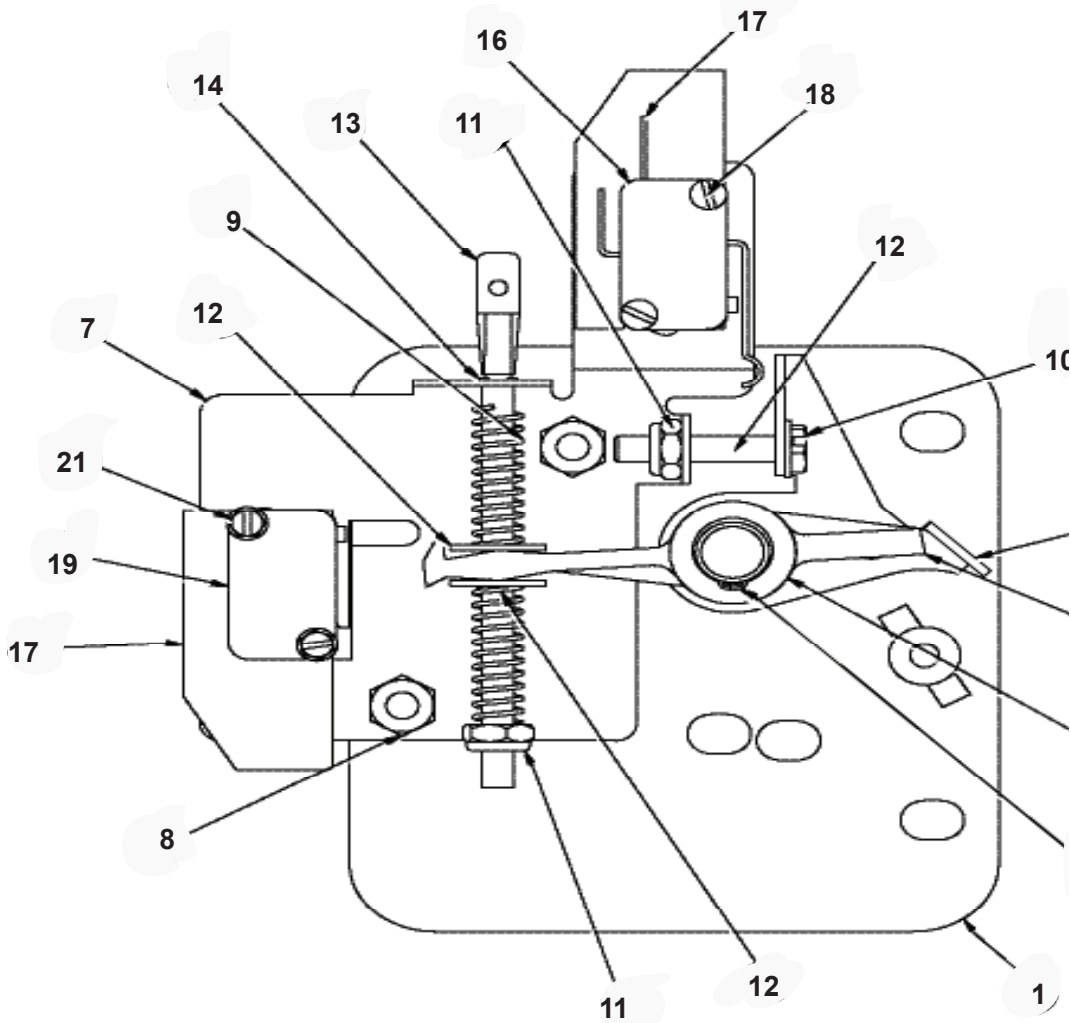

Key	Description	All Models	QTY
33	Lock Assy, Complete (#1-22) (includes #1 thru #22)	9885-024-001	1
1	Plate Assy, Door Lock	9982-346-001	1
2	Washer, Flat (SS or Brass)	8641-581-030	1
3	Actuator, Latching Switch	9008-005-001	1
4	Pawl, Locking	9450-002-004	1
5	Washer, Spring	8641-569-003	1
6	Ring, Retaining	9487-200-004	1
7	Bracket Switch	9029-163-001	1
8	Nut, Hex 10-32 UNF	8640-413-002	2
9	Spring, Actuating	9534-364-002	1
10	Screw, Hx. 10-32 x 1"	9545-012-020	1
11	Nut, Elastic Stop 10-32	8640-413-004	2
12	Spring, Return	9534-364-001	2
13	Pin, Guide	9451-193-001	1

Key	Description	All Models	QTY
14	Ring, Retaining	9487-200-005	1
15	Washer	8641-581-031	1
16	Switch, Latching Sensing	9539-461-008	1
17	Shield, Switch	9550-169-003	3
18	Screw 4-40 x 5/8"	9545-020-001	2
18	Nut, Twin	8640-401-001	2
19	Switch, Locking Sensing	9539-461-007	2
20	Actuator, Switch Locking	9008-006-003	1
21	Screw 4-40 x 1 1/8"	9545-020-003	2
21	Spacer Sensor	9538-182-001	1
22	Pin, Dowel (for door cam)	9451-181-004	1
*	Shim, Door Lock, Thin	9552-037-001	AR
*	Screw, Lock mtg 1/4"-20 x 3/4"	9545-018-014	3
*	Lockwasher 1/4" Ext tooth	8641-582-007	3

Gear Motor Door Lock Assembly

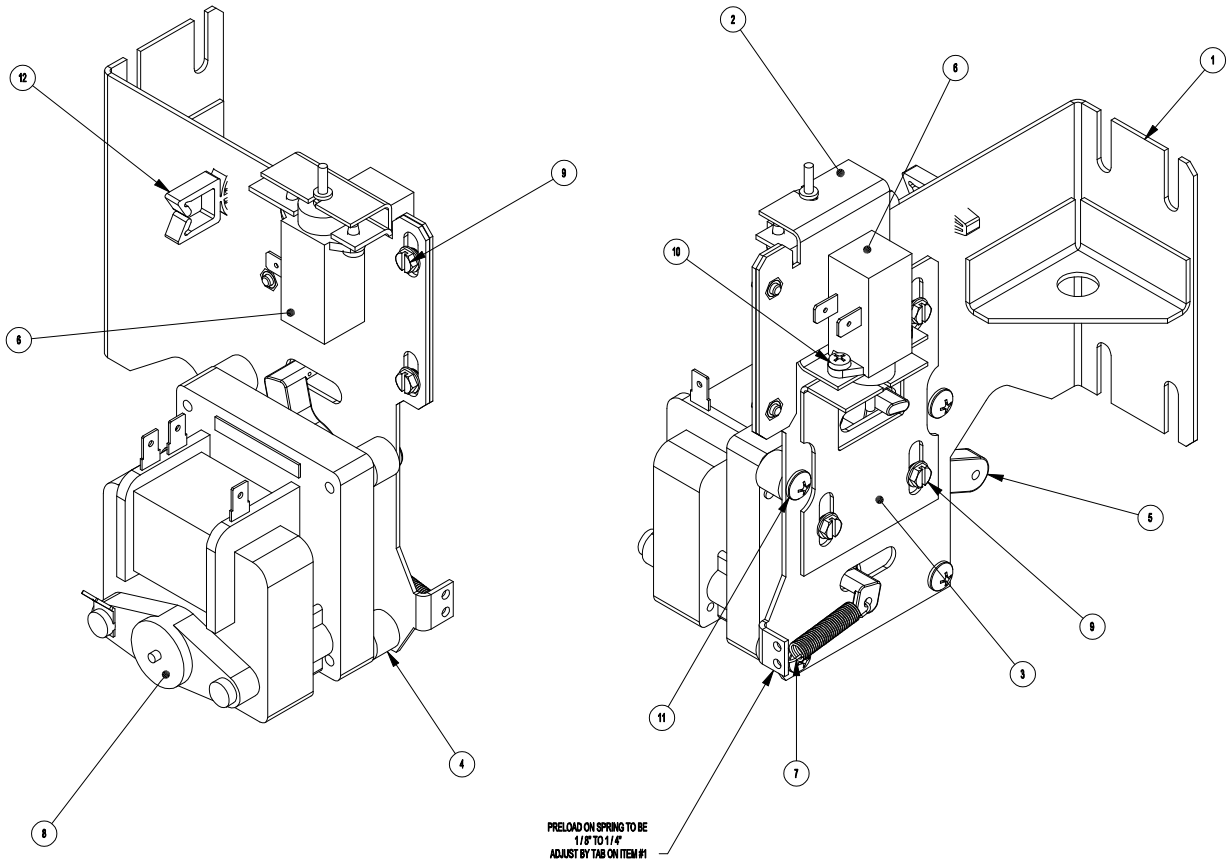

Key	Description	T900	T1200	QTY
*	Actuator Assembly (Includes 1-10, Rod NOT included)	9892-014-001	9892-014-001	1
11	Screw Pnhdcr, 10-32 UNFx0 .75	9545-012-027	9545-012-027	4
10	Cross Recessed PAn Hd Tapping screw	9545-031-011	9545-031-011	4
9	Screw -Hxwshrhdslsems, 6-32 x 3/16	9545-044-003	9545-044-003	6
8	Motor & Gear Assembly 120v	9914-137-015	9914-137-015	1
7	Spring - Extension	9534-350-001	9534-350-001	1
6	Thermoactuator - Door Lock Relay 120v	9586-001-001	9586-001-001	2
5	Arm - Door Lock	9001-063-001	9001-063-001	1
4	Spacer, Plastic	9538-157-021	9538-157-021	4
3	Bracket Slide Lock	9029-204-001	9029-204-001	1
2	Bracket Assy, Slide - Unlock	9985-189-001	9985-189-001	1
1	Bracket Assy, Slide Lock Actuator	9985-190-001	9985-190-001	1
*	Rod, Door Lock	9497-225-015	9497-225-015	1

Large Door & Hinge Group

(After #514975)

Key	Description	T900	T1200	QTY
1	Door Hinge Assembly (mounts to tub front)	9955-031-001	9955-031-001	1
*	Door Assembly Complete	9960-310-001	9960-310-001	1
2	Door Ring 180 degree large hnge	9487-275-001	9487-275-001	1
3	Door Gasket	9206-431-001	9206-431-001	1
4	Door Glass Window	9635-020-001	9635-020-001	1
*	Red Wire (Door Close Switch)	8220-063-028	8220-063-028	1
	Black Wire (Door Close Switch)	8220-063-029	8220-063-029	1
5	Switch, Door Hinge Close (Plunger)	9539-492-001	9539-492-001	1
6	Top Door Hinge Leaf (No pin)	9845-006-001	9845-006-001	1
7	Bottom Door Hinge Leaf	9845-007-001	9845-007-001	1
8	Thrd Form Screw, Door Mtg 5/16" x 5/8"	9545-056-002	9545-056-002	4
9	Screw, Loading Door Hinge Mtg (5/16" x9/16" ss)	9545-014-013	9545-014-013	3
10	Bracket Retainer support side panel	9046-085-001	9046-085-001	1
*	Shim Large door	9552-043-001	9552-043-001	1

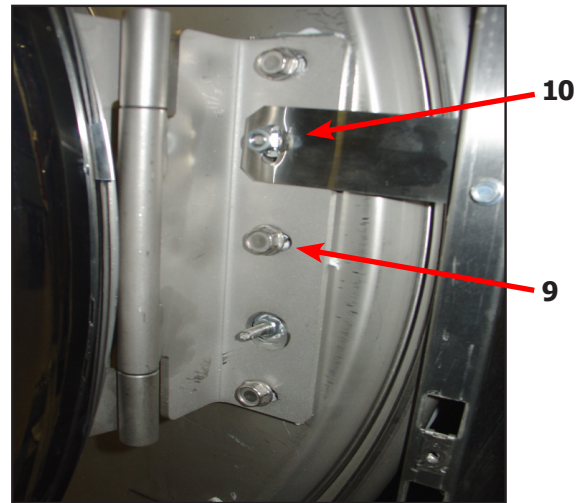

Key	Description	T-900	T1200	QTY
11	Shaft, Door Locking	9537-195-002	9537-195-002	1
12	Cam, Locking	9095-040-002	9095-040-002	1
13	Pin, Groove (1 1/4)	9451-181-005	9451-181-005	1
14	Pin, Groove (3/4)	9451-181-004	9451-181-004	1
15	Spring, Lock Cam	9534-360-002	9534-360-002	1
16	Handle, Door	9244-091-001	9244-091-001	1
17	Pin, Door Handle (groove)	9451-181-005	9451-181-005	1

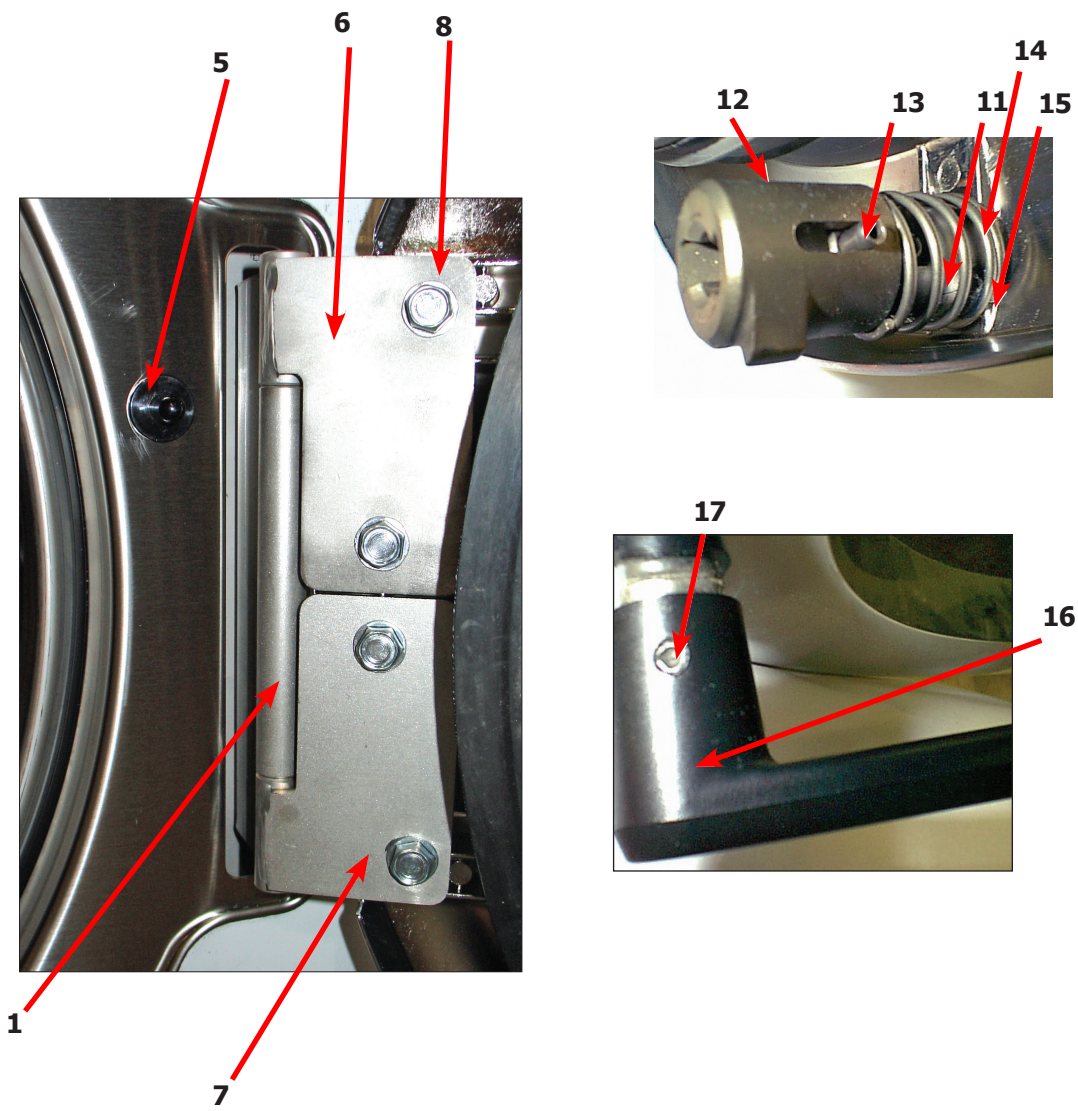

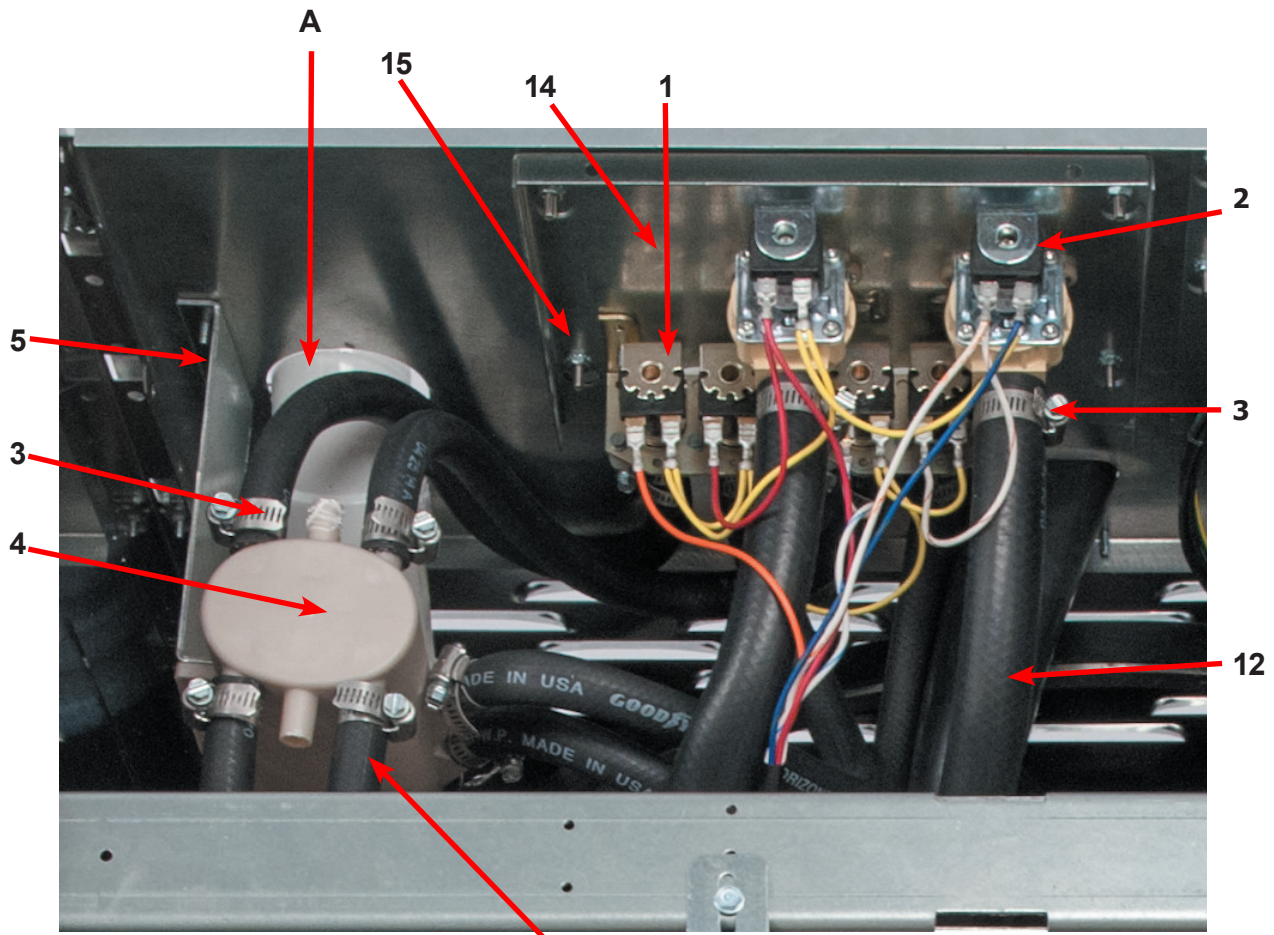

11

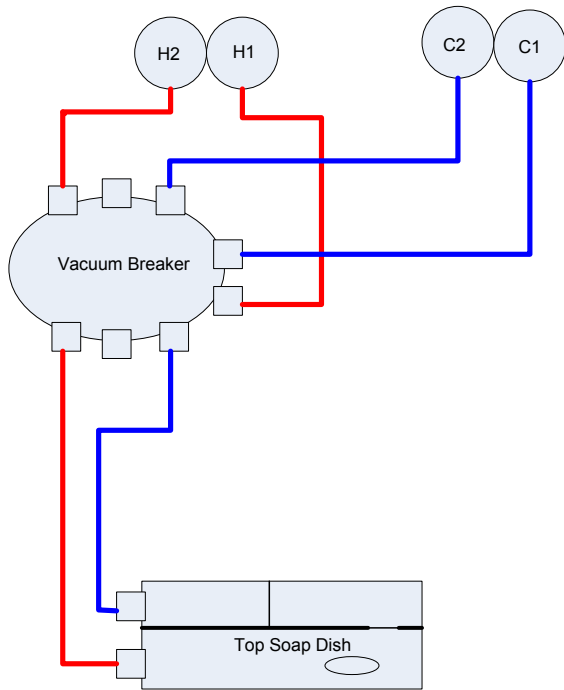

Top Soap Box Design

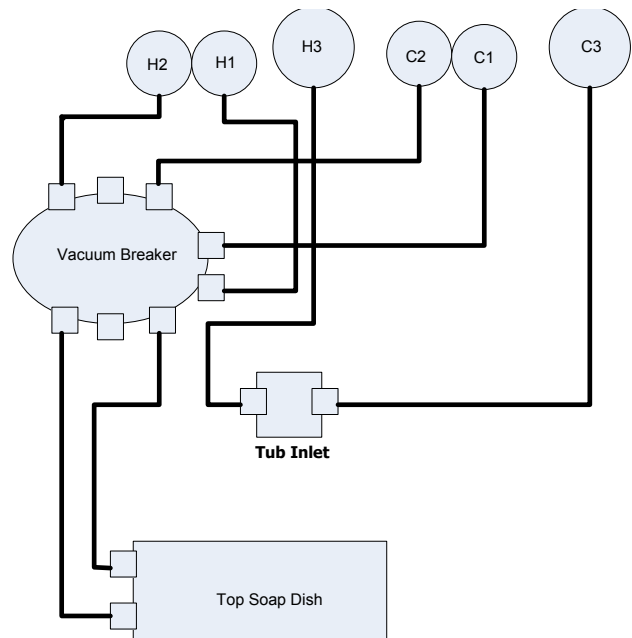

Top Soap Box 4 Valve Design

Water Inlet Part # by Model

Key	Description	T900	T1200	QTY
A	Injector Assembly	9883-012-001	9885-012-001	1
1	Valve, Water Inlet (dual outlet) (see Water Inlet Valve Breakdown for individual parts)	9379-183-012	9379-183-012	2
*	Screw, Valve Mtg	9545-008-026	9545-008-026	2
2	Valve Water Inlet (single outlet)	9379-194-001	9379-194-001	2
*	Screw, Valve M4x0.7x8mm	9495-064-001	9545-064-001	8
3	Clamp-Water Valves	8654-117-008	8654-117-008	AR
*	Shield over Water Valves Plastic	9550-195-001	9550-195-001	1
*	Clip-Push	9083-121-001	9083-121-001	4
4	Vacuum Breaker	9610-001-001	9610-001-001	1
5	Bracket, Vacuum Breaker	9029-077-001	9029-077-001	1
*	Screw	9545-008-026	9545-008-026	4
6	New Front Mount Soap Box, 2 port		9732-290-001	1
7	Fitting, Cross (new soap bhox)		8615-118-001	
*	Clamp, Vacuum Breaker End	8654-117-014	8654-117-014	1
9	Hose, Vacuum Breaker to Tub Injection Tube	9242-461-001	9242-461-001	1
10	Flow restrictor	9475-002-002	9475-002-002	2
13	Flow restrictor	9475-002-002	9475-002-003	3
*	Tub Fill Inlet Cap	0935-135-001		2
14	Plate-Water Valves, Mounting	9452-814-001	9452-814-001	1
15	Nut, #10-32UNF, 2B	8460-413-002	8460-413-002	4

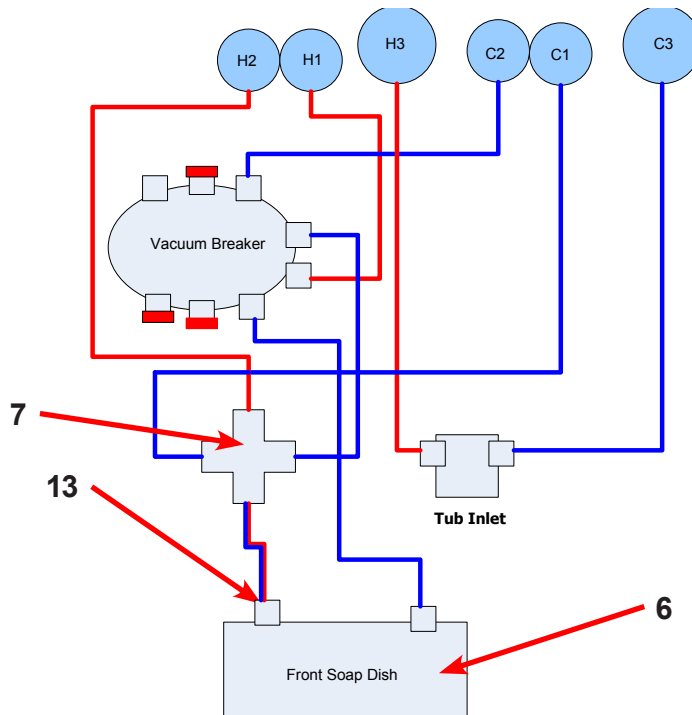

New Front Soap Box Design

Water Inlet Valve Breakdown Part # by Model

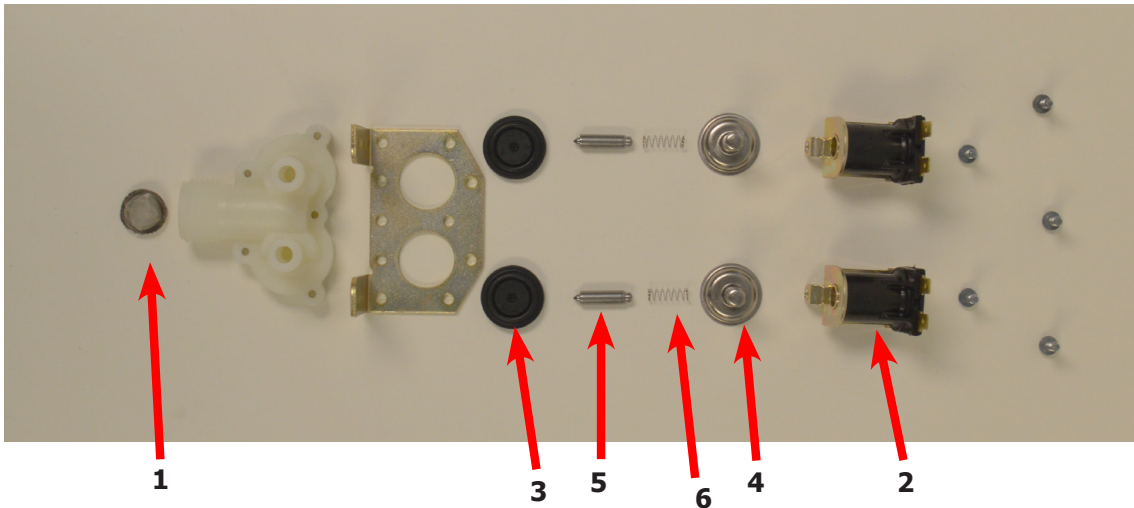

Key	Description	T900	T1200	QTY
*	Valve, Water Inlet (includes 1 thru 6)	9379-183-012	9379-183-012	2
1	Screen, Inlet end of valve	9555-056-001	9555-056-001	2
2	Coil Assy., 120 V Invensys	9089-017-001	9089-017-001	2
*	Diaphragm Invensys (EPDM)	9118-049-001	9118-049-001	2
*	Diaphragm Invensys (Viton)	9118-049-002	9118-049-002	2
3	Diaphragm Invensys (EPDM NSF)	9118-049-003	9118-049-003	2
4	Guide, Solenoid Invensys	9211-021-002	9211-021-002	2
5	Armature Invensys	9015-008-001	9015-008-001	2
6	Spring, Armature Invensys	9534-298-001	9534-298-001	2

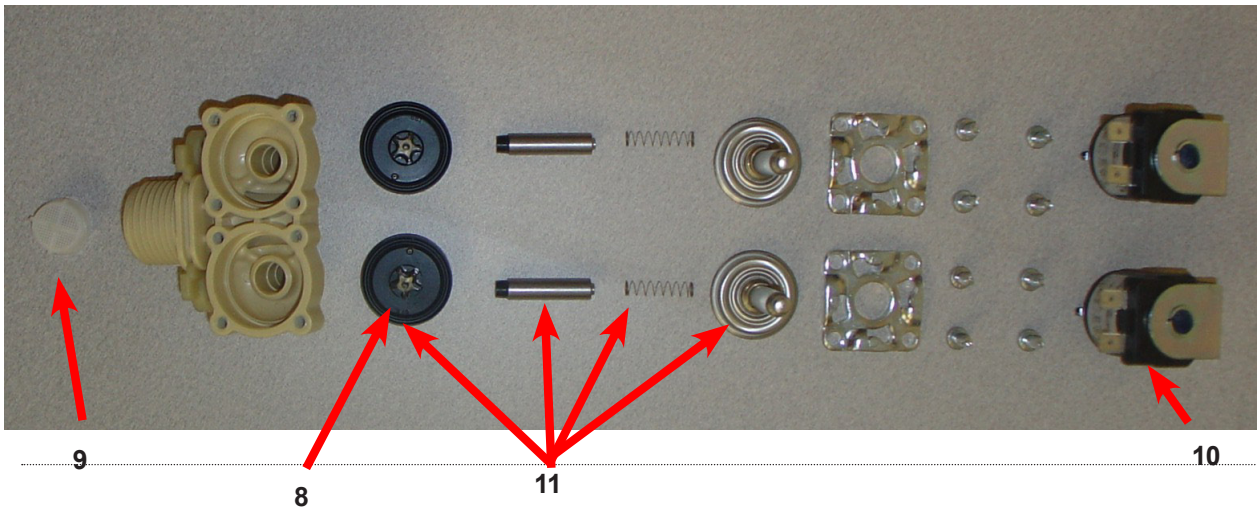

Optional Water Valve

Key	Description	T900	T1200	QTY
*	Dual Coil Water Valve Mueller	9379-192-001	9379-192-001	1
7	Valve Water Body Complete(no coil)	9379-192-002	9379-192-002	1
8	Diaphragm Mueller	9118-054-001	9118-054-001	2
9	Filter Mueller	9183-046-001	9183-046-001	2
10	Coil Mueller	9089-051-001	9089-051-001	2
11	Diaphragm Assembly Mueller Includes	9785-001-001	9785-001-001	2

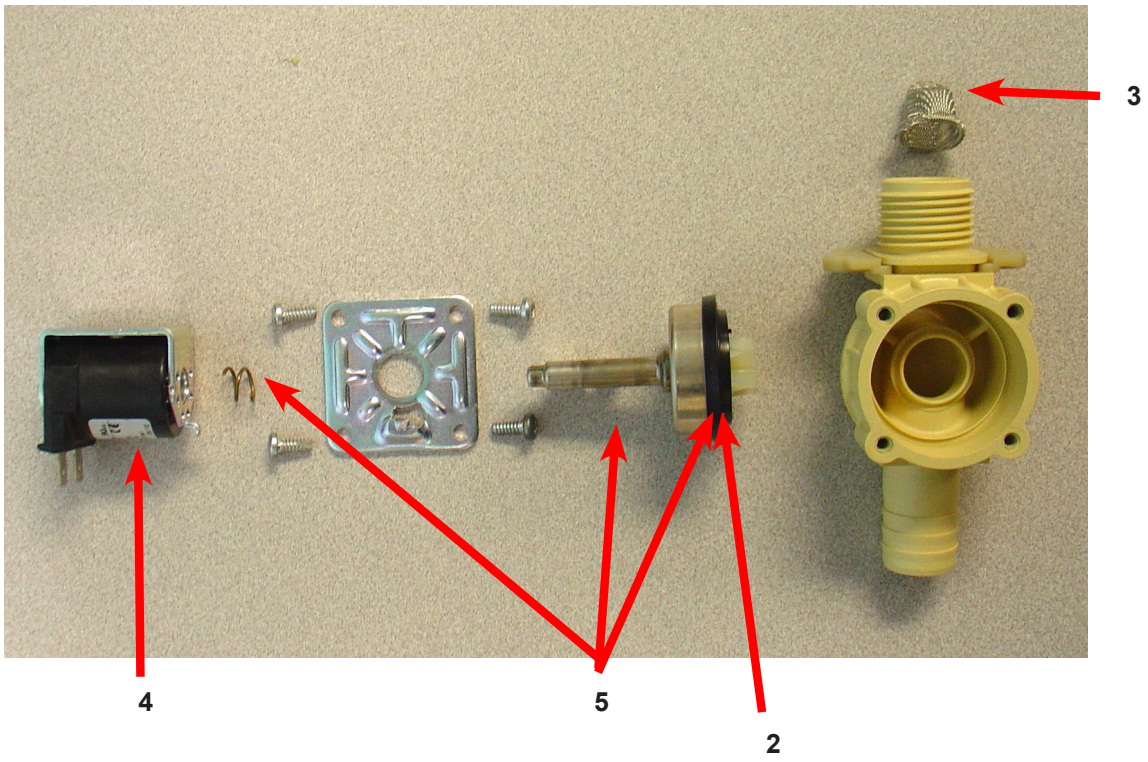

Key	Description	T900	T1200	QTY
*	Single Coil Water Valve Mueller		9379-194-001	1
1	Valve Water Body Complete (no coil)		9379-194-002	1
2	Diaphragm Mueller		9118-055-001	1
3	Filter Mueller		9183-046-001	1
4	Coil Mueller		9089-051-001	1

Drain Valve Group Part # by Model

Key	Description	Part Number	Qty
1	Valve, Drain (includes #2 thru #11)	9379-202-001	1
2	Body, Valve (w/ball)	9064-072-001	1
3	Motor & Gear Train (complete)	9914-137-023	1
4	Plate, Motor Mtg	9452-538-001	1
5	Screw	8639-994-001	1
6	Spring, Drive	9534-339-001	1
7	Screw	9545-054-001	1
8	Screw	9545-054-002	1
9	Seal, V Packer	9532-134-001	1
10	Washer	8641-584-001	1
11	Pin, Main Drive	9451-196-001	1
*	Plate (spacers needed for replacement motor mtg. plate)	9538-149-001	1
12	Kit - Seal Replacement	9732-327-001	1

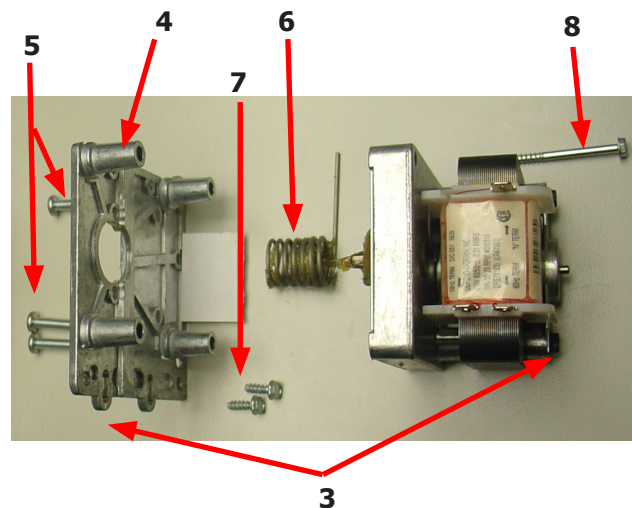
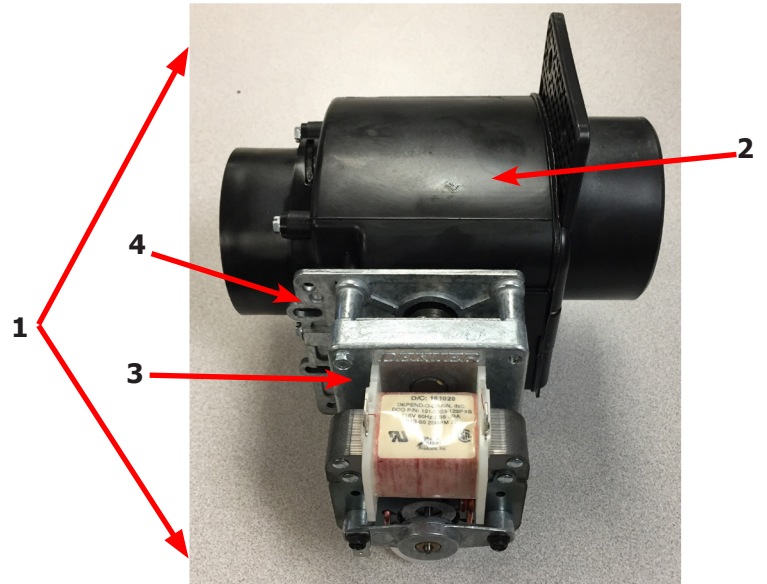
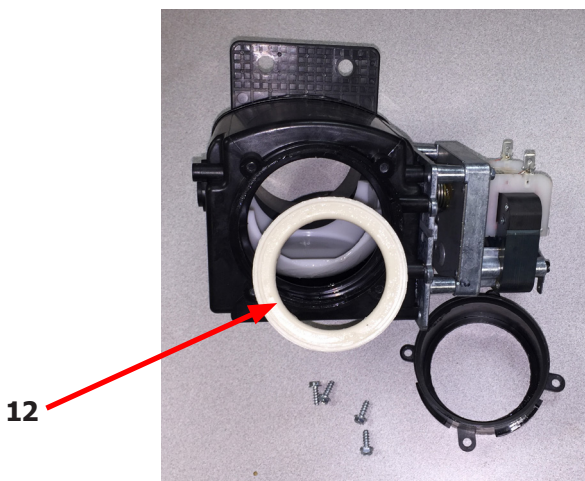

Chassis and Drain Part # by Model

Key	Description	T-900	T-1200	QTY
1	Base Assy,Frame	9945-128-002	9945-125-002	1
2	Outer Tub Assy.	9930-157-001	9930-150-001	1
*	Tub & Cylinder Assy.	9869-027-003	9869-022-001	1
3	Tub Front	9974-011-001	9974-011-002	1
*	Gasket, Tub Front	9206-421-002	9206-421-002	1
4	Ring Assy, Tub Mtg-Front Clamp	9950-055-001	9950-055-001	1
5	Bolt, Top Front Ring 3/8"-16 x 3"	9545-029-009	9545-029-009	1
6	Nut WCAD 3/8"-16	8640-415-001	8640-415-001	1
7	Bolt, 1/2" -13 x 2" Rings to Base	9545-017-013	9545-017-013	2
8	Nut, Wizloc 1/2" x 13	8640-417-005	8640-417-005	2
9	Washer, Flat 1/2"	8641-581-026	8641-581-026	2
10	Hose, Tub to Drain Valve	9242-459-001	9242-459-001	1
11	Clamp, Hose (Tub to Drain Valve)	8654-117-014	8654-117-014	2
12	Valve, Drain	9379-200-001	9379-200-001	1
*	Screw, Valve to Base 1/4Bx3/4	9545-030-002	9545-030-002	2
*	Washer, Flat 1/4	8641-581-017	8641-581-017	2
13	Hose, Drain Valve to Tube	9242-457-001	9242-457-001	1
*	Clamp, Hose (Drain Valve to Tube	8654-117-014	8654-117-014	2
14	Tube Assy, Drain	9915-120-004	9915-126-002	1
15	Clamp, Hose (Tube to Frame Bracket)	8654-117-014	8654-117-014	1
*	Bracket, Drain Tube	9029-162-002		1
*	Screw Tube (Bracket to Base 1/4Bx3/4)	9545-030-002	9545-030-002	4
16	Hose, Overflow Tub To Drain Tube	9242-449-003	9242-449-003	1
*	Clamp, Hose	8654-117-018	8654-117-018	2
17	Tube, Suds overflow	9242-463-004	9242-463-004	1
*	Clamp, Hose	8654-117-008	8654-117-008	2
18	Hose, Pressure switch	9242-175-007	9242-175-004	1
	Clamp, Hose	8654-117-015	8654-117-015	1

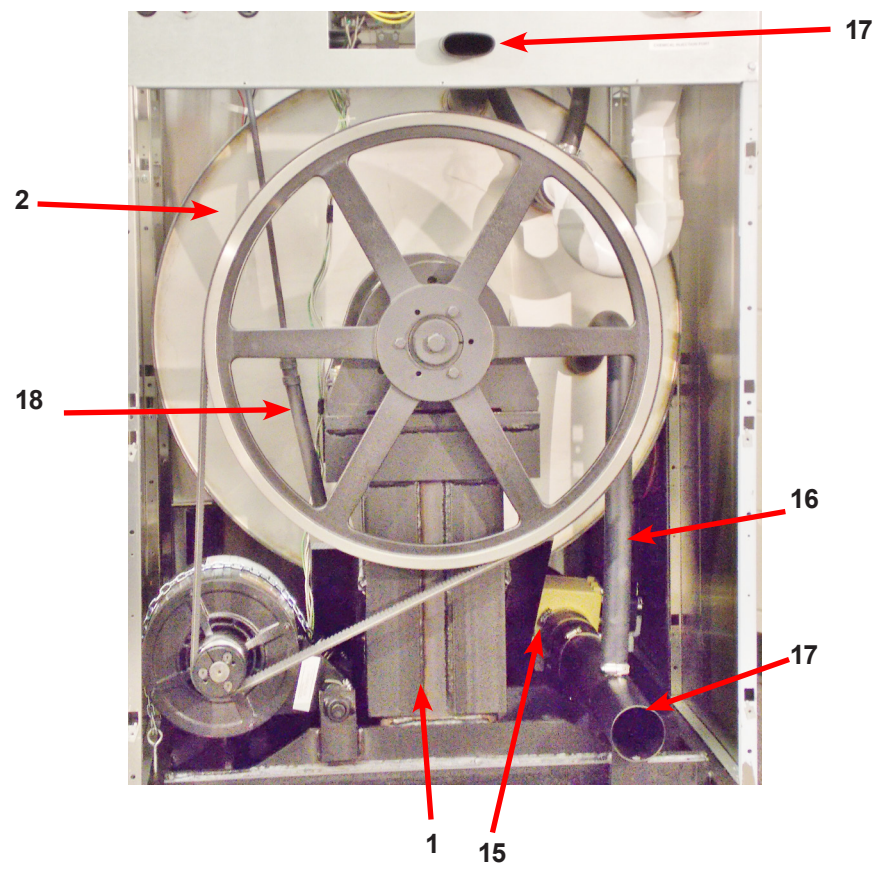
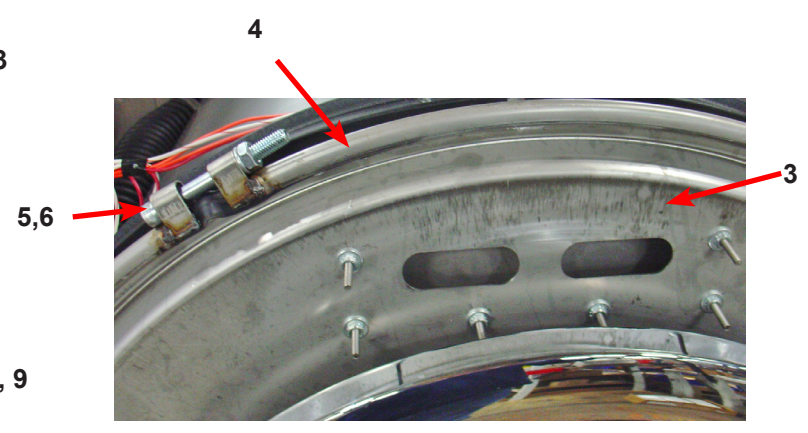
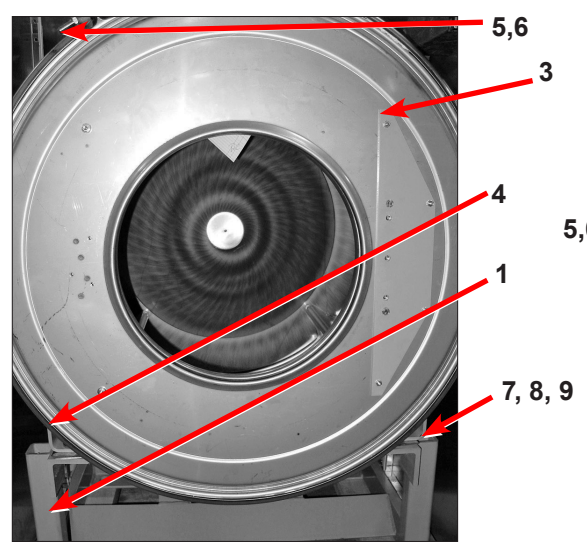
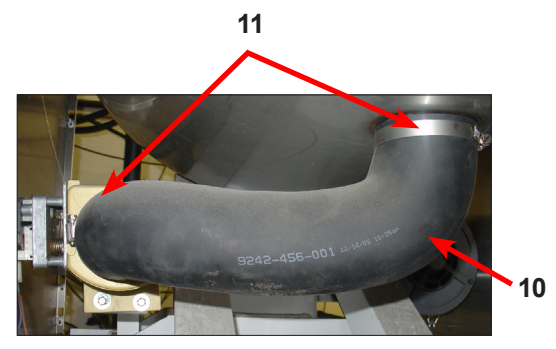
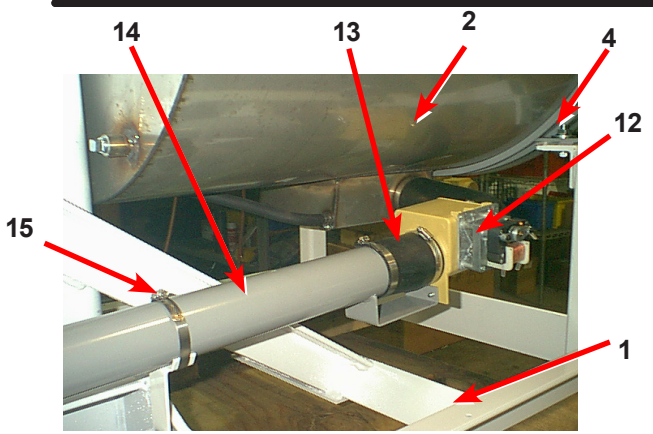

Key	Description	T900	T1200	QTY
1	Trough Assy,Controls 208-240 volt (all parts below #2-#43)	9857-216-001	9857-217-001	1
*	Trough only	9839-018-001	9839-018-001	1
*	Screw, Trough Sides	9545-008-026	9545-008-026	4
*	Lockwasher Exttooth #10	8641-582-006	8641-582-006	4
*	Angle Support Trough	9003-271-001		1
*	Screw, Trough Bracket	9545-008-026	9545-008-026	4
*	Channel-Trough Mounting	9081-108-001	9801-110-001	1
*	Screw-10Bx1/2	9545-008-026	9545-008-026	4
2	Screw GRN. #10-32x 1/2"	8639-621-007	8639-621-007	1
*	Lockwasher #10	8641-582-006	8641-582-006	1
3	Transformer, Control (Secondary Voltage to 115 volts)	8711-004-001	8711-004-001	1
4	Screw, Mtg #8Bx1/4"	9545-045-001	9545-045-001	4
*	Lockwasher #10	8641-582-006	8641-582-006	4
5	Terminal Block Assy, POWER	9897-026-004	9897-026-004	1
*	Screw, Mtg 8Bx3/8"	9545-045-007	9545-045-007	2
6	Transformer, (Step Down) 120/2.3 VAC&24 VAC 50/60hz	8711-009-001	8711-009-001	1
*	Lockwasher #10 exttooth	8641-582-005	8641-582-005	4
7	Screw, Mtg #10Bx1/2"	9545-045-001	9545-045-001	4
8	PCB assembly Relay Main	9473-006-001	9473-006-001	1
*	Support-3/8" Edge Holding	9548-285-001	9548-285-001	6
9	Bushing , Wire 7/8	9053-067-002	9053-067-002	2
*	Wire Assy, Enable-Yellow 32"	8220-064-023	8220-064-023	2
10	Harness, P17 Drain/Therm/Sol	9627-796-002	9627-796-002	1
11	Harness P19/Water Valve	9627-795-002	9627-795-004	1
*	Harness P8/P16 , Control	9627-794-001	9627-794-004	1
12	Harness P20/P21, Enable	9627-793-001	9627-793-001	1
13	Optional Relay board	9473-007-001	9473-007-001	1
14	Support-3/8" Edge Holding	9548-285-001	9548-285-001	4
15	Harness, P10 To Terminal Block	9627-799-001	9627-799-001	1
16	Harness, P15/P23 Injection	9627-798-001	9627-798-001	1
17	Switch, Pressure	9539-490-001	9539-490-001	1
18	Harness P5/Pressure	9627-807-001	9627-807-001	1
*	Standoff Twistlock	9527-002-002	9527-002-002	4
19	Fuse Holder Assy	9200-001-002	9200-001-002	1
*	Fuse, 1.5Amp	8636-018-001		1
*	Fuse, 2.5Amp		8636-018-004	1
20	Label-Fuse, 1.5Amp	8502-716-001		1
20	Label-Fuse, 1.5Amp		8502-716-002	1
*	Terminal Grounding,	8652-130-037	8652-130-037	1
*	Screw 10-32 x 1/2 GRN	9545-008-027	9545-008-027	1
*	Lockwasher, #10	8641-582-006	8641-582-006	1
*	Kit-Pressure Sensor, Electronic	9732-314-001	9732-314-001	1
21	Kit-Repaacement, Pressure Sensor (only)	9732-315-001	9732-315-001	1
*	Support-PCB, 3/8", Edge Holding	9458-285-001	9458-285-001	1
22	Transformer-120/18VAC, 5 VA	8711-015-001	8711-015-001	1
23	Screw, 8B x 1/4	9545-045-001	9545-045-001	1
*	Wire Assy BLK/BLU	8220-001-233	8220-001-233	1
*	Wire Assy RED/BLU	8220-001-232	8220-001-232	1

Electrical Components - Top Compartment

Mechanical Pressure Switch

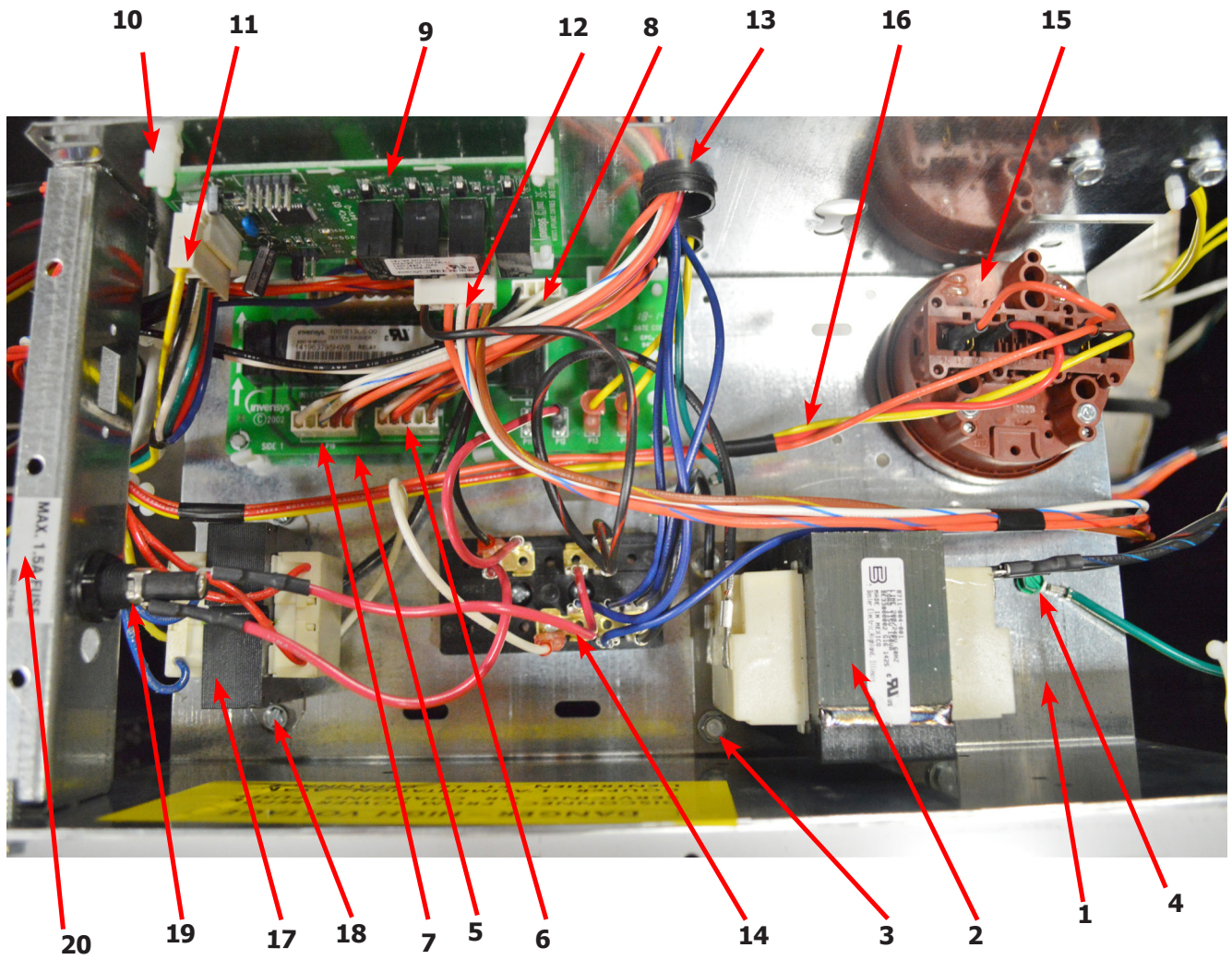

Electronic Pressure Sensor

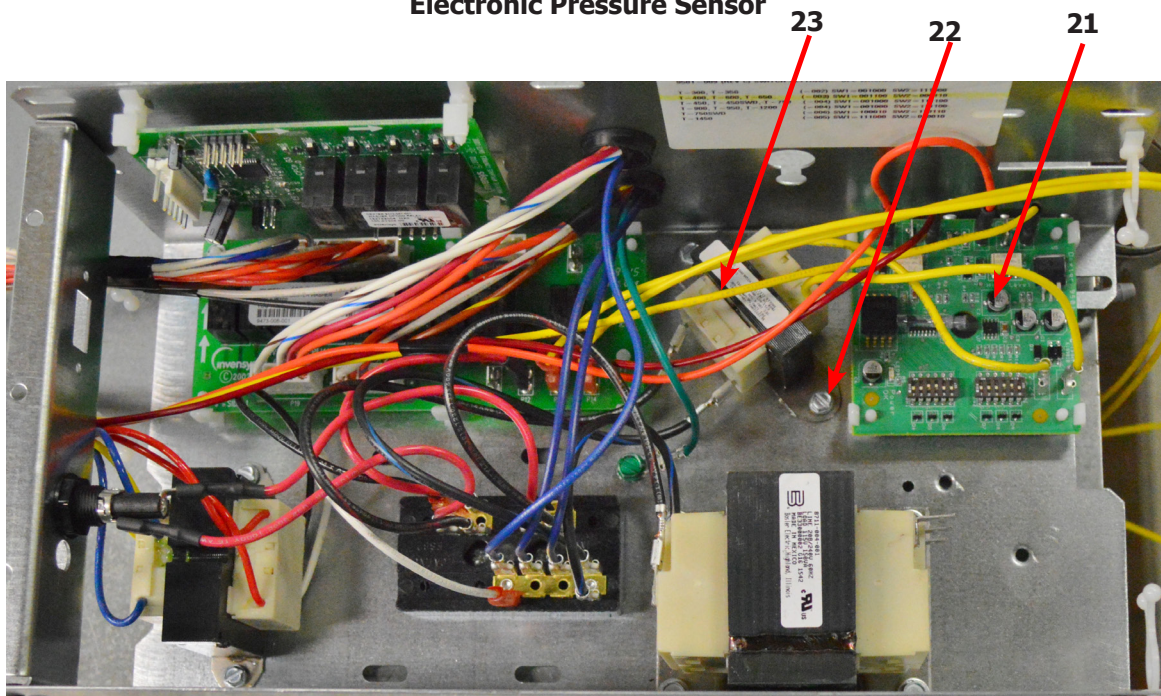

Control Panel Part # by Model

Key	Description	T900	T1200	QTY
1	Panel Control Assembly(panel only) After Serial #530673	9989-480-001	9989-456-001	1
2	Nameplate,Control Panel (one piece) Black	9412-224-001	9412-229-001	1
*	Screw-Hxwshrhdundct #10Bx 1/2"(Control Panel To side Panel)	9545-008-026	9545-008-026	4
3	Plastic Shield over main PCB	9550-184-001	9550-184-001	1
4	Nut Hexkeps #8-32	8640-412-005	8640-412-005	3
5	Screw FillHDCR 10Bx1/2" Guide	9545-008-023	9545-008-023	1
6	Locator Panel	9355-001-001	9355-001-001	1
7	Plate -Latch, Top	9452-625-001	9452-625-001	2
8	Nut Hexkeps #8-32	8640-412-005	8640-412-005	4
9	Spacer Pushbutton (Micro)	9538-178-001	9538-178-001	1
10	Pushbutton Control (OPL), Black	9035-060-004	9035-060-004	1
11	Retainer Pushbutton (Micro)	9486-158-001	9486-158-001	1
12	Nut Hexelasticstop #4-40	8640-424-002	8640-424-002	2
13	Spacer Plastic #6x9/16	9538-157-018	9538-157-018	5
14	PCB assembly Control /Display	9473-004-008	9473-004-008	1
15	Nut Elasticstop #6-32	8640-411-002	8640-411-002	4
16	Nut Hexkeps #6-32	8640-411-003	8640-411-003	1
17	Spacer Plastic #6x9/16	9538-157-018	9538-157-018	2
18	PCB assembly Mode lights	9473-005-001	9473-005-001	1
19	Nut Hexkeps #6-32	8640-411-003	8640-411-003	2
20	Harness-LED PCB, P3	9627-797-001	9627-797-001	1
21	Spacer Plastic #6x9/16	9538-157-018	9538-157-018	2
22	Light, LED,ADD BLEACH Asembly	9794-001-001	9794-001-001	1
23	Nut Hexkeps #6-32	8640-411-003	8640-411-003	2
24	Lock-Run/Program, w/Harness & Key, P2	8650-027-001	8650-027-001	1
*	Key (N561)	6292-006-013	6292-006-013	AR
25	Actuator Assy-Door Locking, 120V	9892-015-001	9892-015-001	1
26	Nut Hexkeps #8-32	8640-412-005	8640-412-005	4
27	Nut-Spring	8640-399-008	8640-399-008	2
28	Bracket-Retainer, Front Panel	9029-191-001	9029-191-001	1
29	Screw FillHDCR 10Bx1/2" Guide	9545-008-023	9545-008-023	2
*	Harness-Optional relay, P23-P15	9627-798-001	9627-798-001	1
*	Harness-PCB to Relay, P8-P16	9627-794-001	9627-794-001	1
*	Harness-Door Lock, P4	9627-791-005	9627-791-005	1
*	Harness-PCB to Enable, P20-P21	9627-793-001	9627-793-001	1
*	Transformer-120V/24/5.3, P7	8711-009-001	8711-009-001	1
*	Harness-Pressure Switch, P5	9627-807-001	9627-807-001	

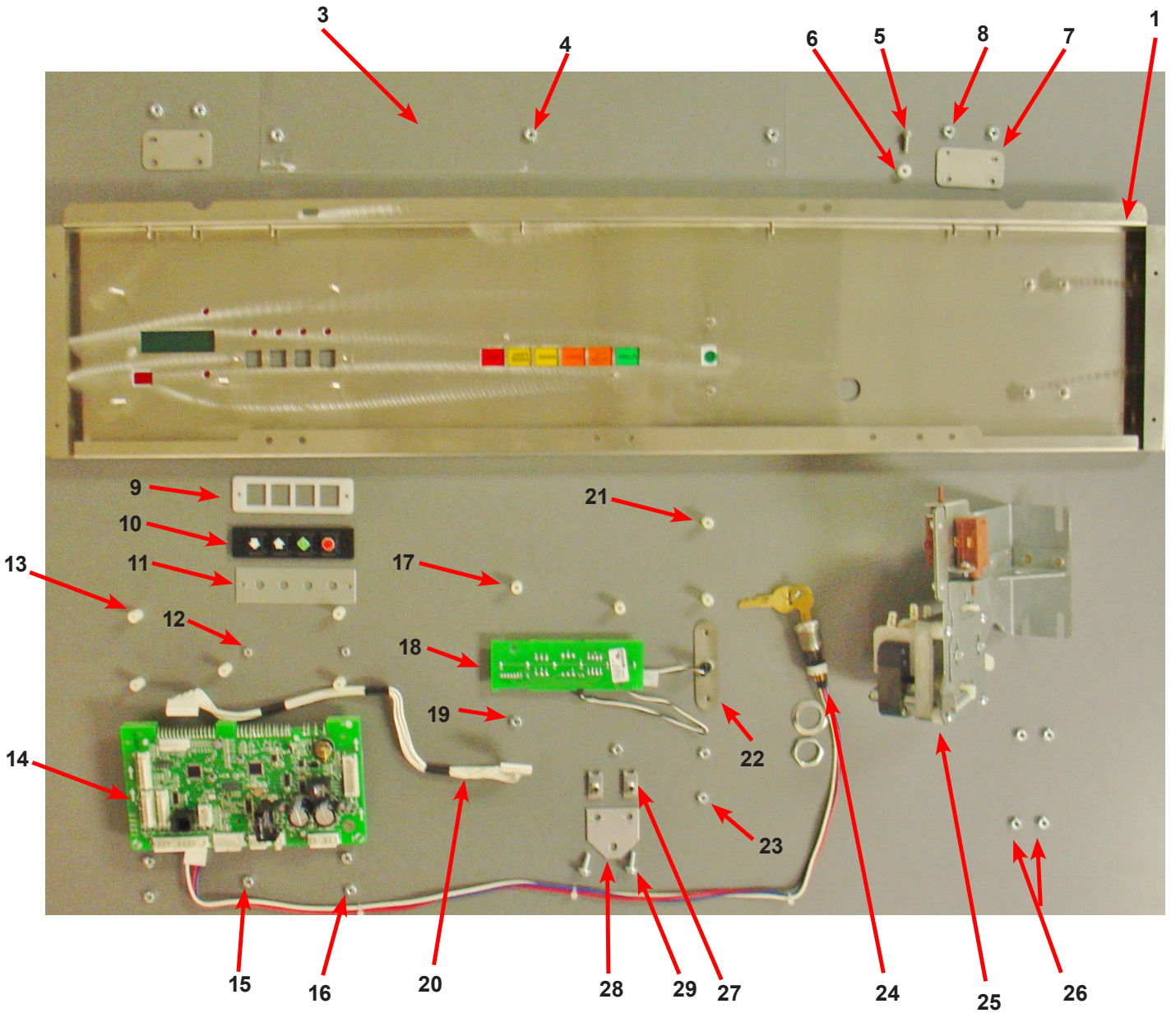

Labels and Diagrams All C-Series Models

Key	Description	T900	T1200	QTY
*	Operators Manual	8514-243-001	8514-245-001	1
	Wiring Schematic & Diagram	9506-558-001	9506-562-001	1
*	Transient Voltage Surge Suppressor Infomational	8507-330-001	8507-330-001	1
*	Instructions Spin Direction	8507-275-001	8507-275-001	1
*	Label High Voltage Warning	8502-614-004	8502-614-004	1
*	Label Fusing & Installation	8502-619-003	8502-619-003	1
*	Label Quality	8511-001-002	8511-001-002	1
1	Label Warning Risk of Injury (Black)	8502-759-001	8502-759-001	1
2	Label Warning Door Opening (Black)	8502-757-001	8502-757-001	1
3	Label Dispenser (Black)	8502-745-001	8502-745-001	1
	Label, Injector Assembly	8502-666-001	8502-666-001	1



Risk of Injury Label



Door Label



Top Dispenser Label Front Soap Dish



Section :9

Parts 50Hz

Models:

Parts in this section used only in these models. All other parts are same as standard 60 Hz pages.

Wiring Diagrams & Schematics

WN0750XA-39XV	208-240 volts	60hz.	Single Phase or Three Phase
WN0900XA-39XV	208-240 volts	60hz	Single Phase or Three Phase
WN0950XA-39XV	208-240 volts	60hz	Single Phase or Three Phase
WN1200XA-39XV	208-240-volts	60hz	Single Phase or Three Phase
WN1450XA-39XV	208-240 volts	60 hz	Single Phase or Three Phase

Transformer, Electrical Filter -39 models

Key	Component	T900	T1200	QTY
1	Circuit Breaker	5198-211-002	5198-211-002	1
*	Harness, Power Terminal block	9627-747-006	9627-747-006	1
*	Assembly, Control Trough	9857-216-003	9857-217-002	1
*	Instructions, Transformer Connect	8507-449-002	8507-449-002	1
2	Control Transformer	8711-004-003	8711-004-003	1
3	Transformer, Step Down	8711-009-003	8711-009-003	1
*	Strip, Marker-Injection	9558-028-002	9558-028-002	1
*	Wiring Schematic & Diagram	9506-559-001	9506-563-001	1
	Operators Manual	8514-243-002	8514-245-002	
	Water Valve	9379-183-011	9379-183-011	
	Diaphragm Invensys (EPDM)	9118-049-001	9118-049-001	
	Diaphragm Invensys (Viton)	9118-049-002	9118-049-002	
	Water Valve Single		9379-194-003	
	Diaphragm Mueller		9118-055-001	
	Wiring Harness, Power Terminal Block	9627-747-006	9627-747-006	
	Wiring Harness Main, 1.5	9627-914-001	9627-914-001	

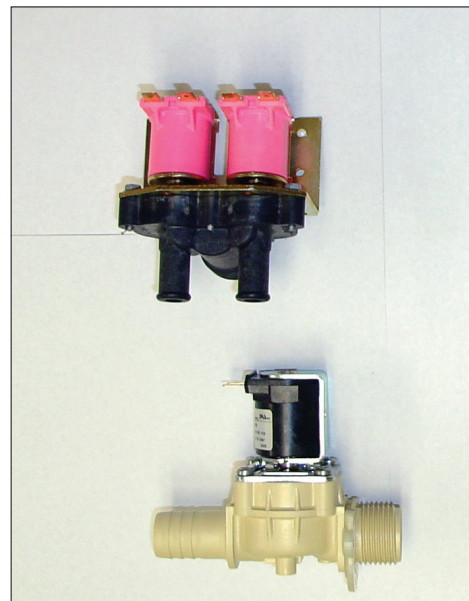
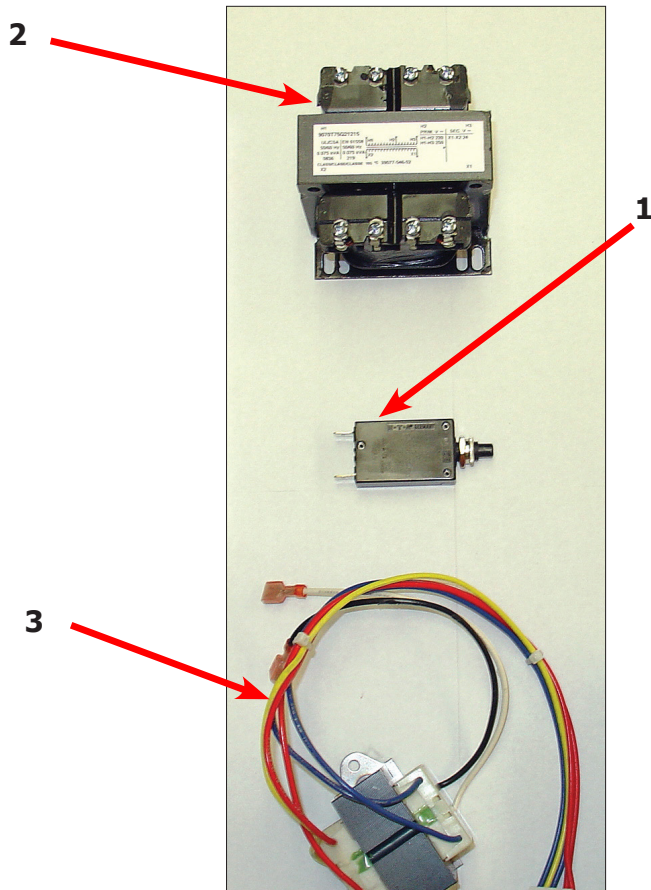

Drain Valve Group Part 50 HZ

Key	Description	Part Number	Qty
1	Valve, Drain (includes #2 thru #11)	9379-202-002	1
2	Body, Valve (w/ball)	9064-072-001	1
3	Motor & Gear Train (complete)	9914-137-022	1
4	Plate, Motor Mtg	9452-538-001	1
5	Screw	8639-994-001	1
6	Spring, Drive	9534-339-001	1
7	Screw	9545-054-001	1
8	Screw	9545-054-002	1
9	Seal, V Packer	9532-134-001	1
10	Washer	8641-584-001	1
11	Pin, Main Drive	9451-196-001	1
*	Plate (spacers needed for replacement motor mtg. plate)	9538-149-001	1
12	Kit - Seal Replacement	9732-327-001	1

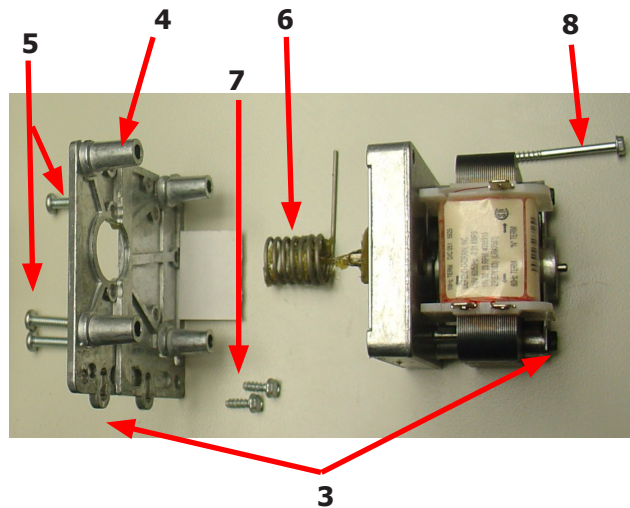
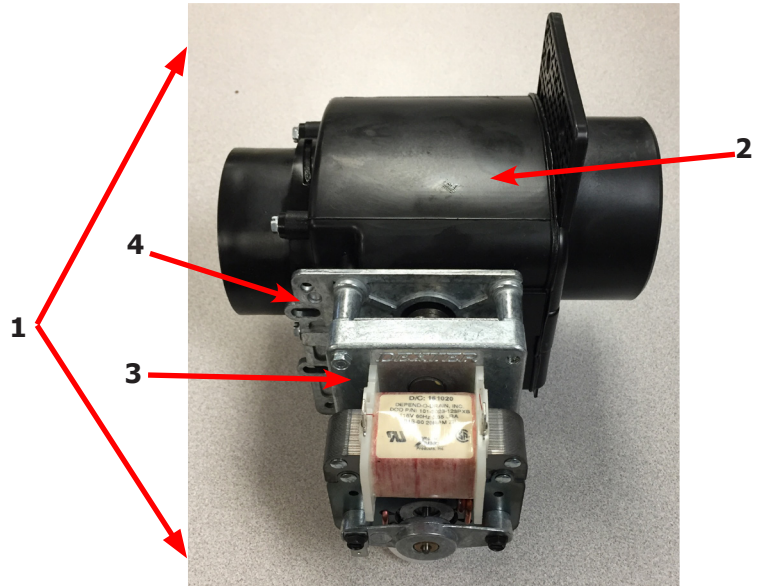
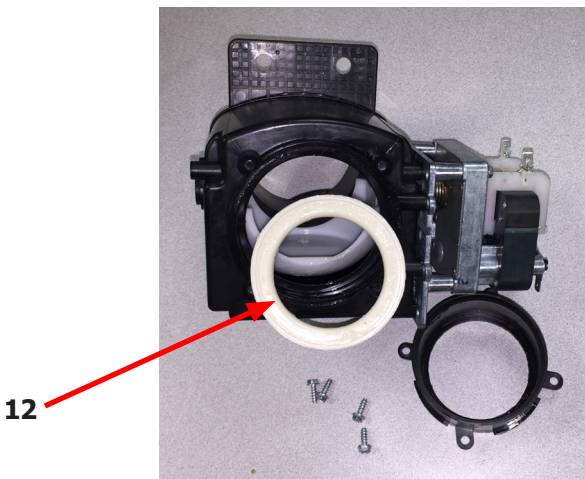

Gear Motor Door Lock Assembly 24V AC

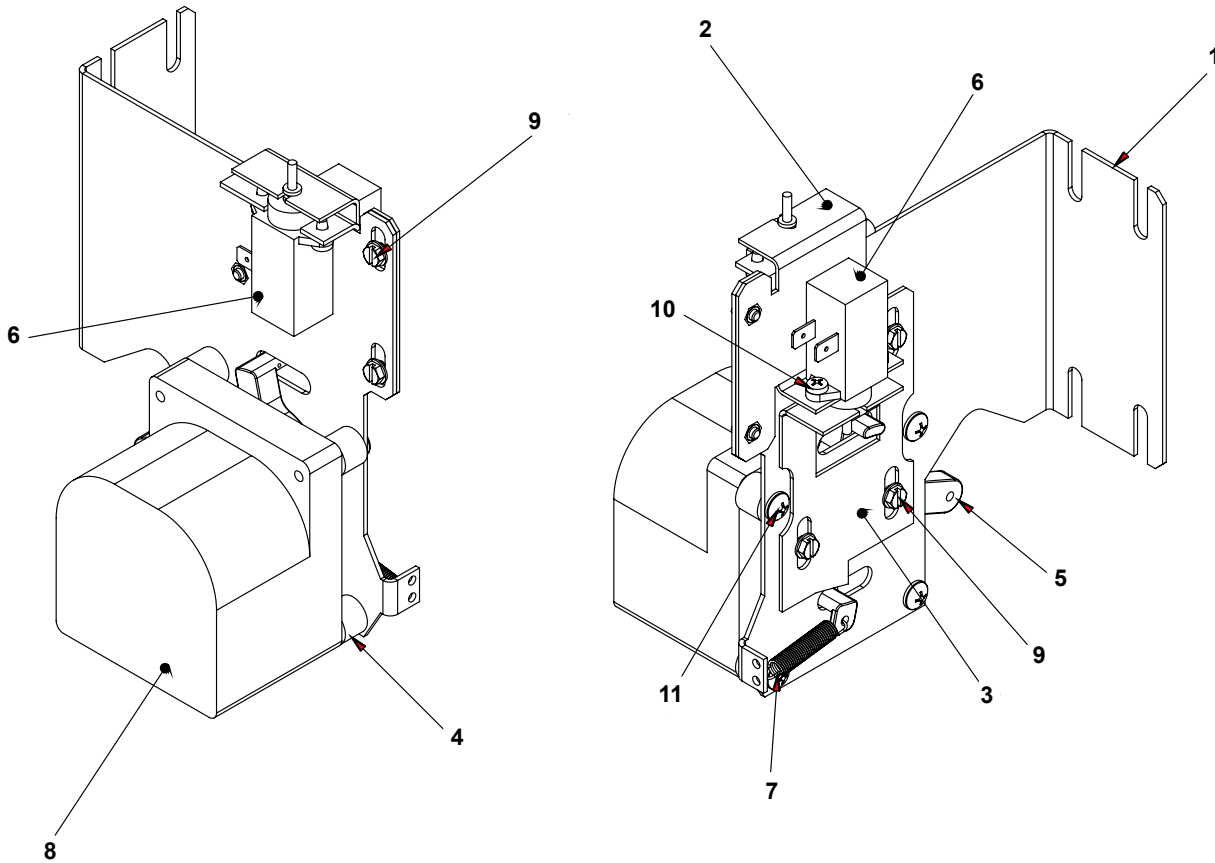

Key	Description	T900	T1200	QTY
*	Actuator Assembly (Includes 1-10, Rod NOT included)	9892-015-002	9892-015-002	1
1	Bracket Assy, Slide Lock Actuator	9985-190-001	9985-190-001	1
2	Bracket Assy, Slide - Unlock	9985-189-001	9985-189-001	1
3	Bracket Slide Lock	9029-204-001	9029-204-001	1
4	Spacer, Plastic	9538-157-021	9538-157-021	4
5	Arm - Door Lock	9001-063-001	9001-063-001	1
6	Thermoactuator - Door Lock Relay 24VAC	9586-001-003	9586-001-003	2
7	Spring - Extension	9534-350-001	9534-350-001	1
8	Motor & Gear Assembly 24VAC	9914-137-009	9914-137-009	1
9	Screw -HxwshrhdsIsems, 6-32 x 3/16	9545-044-003	9545-044-003	6
10	Cross Recessed PAN Hd Tapping screw	9545-031-011	9545-031-011	4
11	Screw Pnhdcr, 10-32 UNFx0.75	9545-012-029	9545-012-029	4
*	Rod, Door Lock	9497-225-015	9497-225-015	1

T900 230/50/1 Voltage Diagram

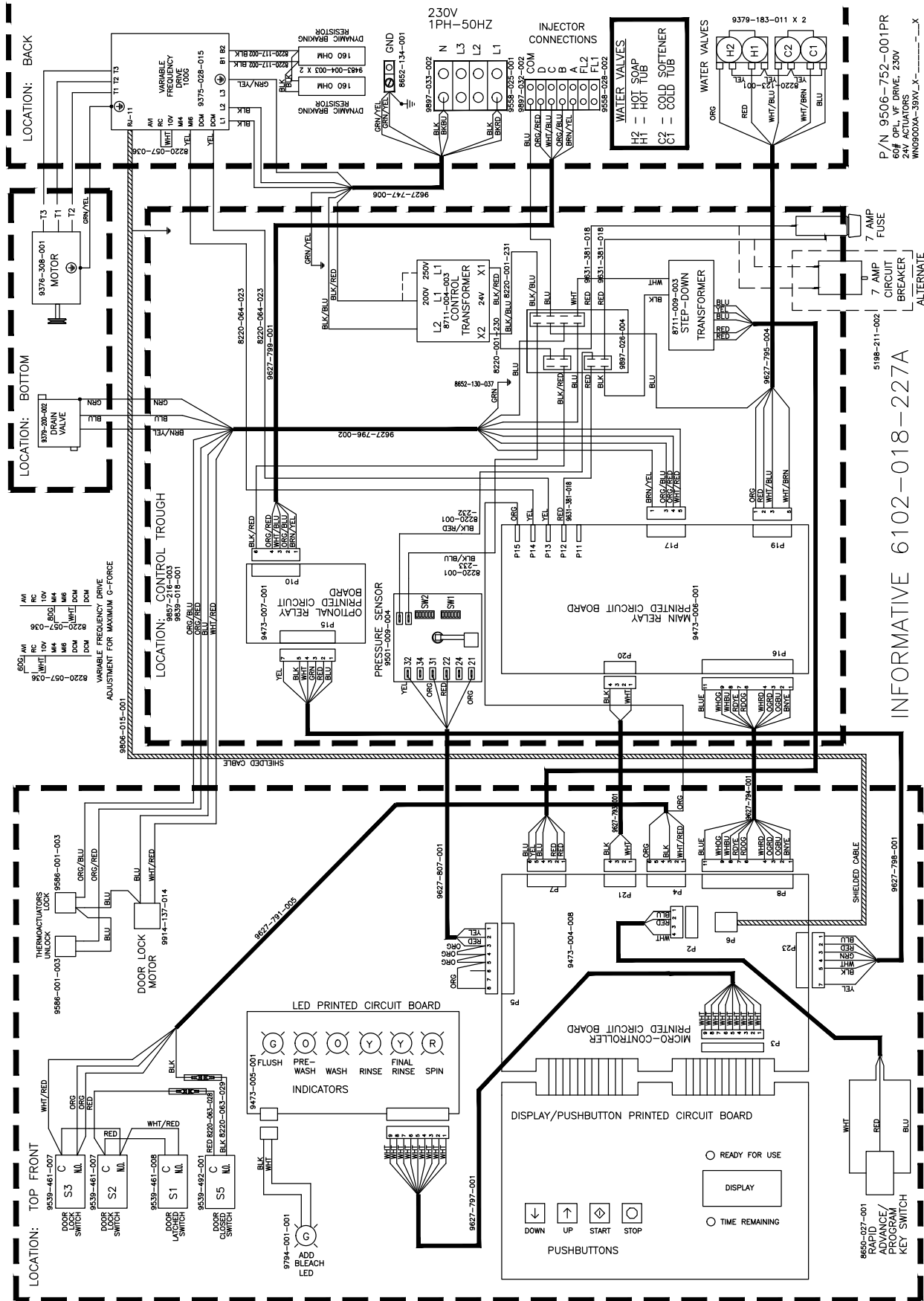

P/N 9506-752-001PR
60# DPL, VF DRIVE, 230V
WING000A-38X_X-----X

INFORMATIVE 6102-018-227A
5198-211-002 7 AMP FUSE
CIRCUIT BREAKER
ALTERNATE

WIRING DIAGRAM 230V, 1PH, 50HZ

T1200 230/50/1 Voltage Diagram

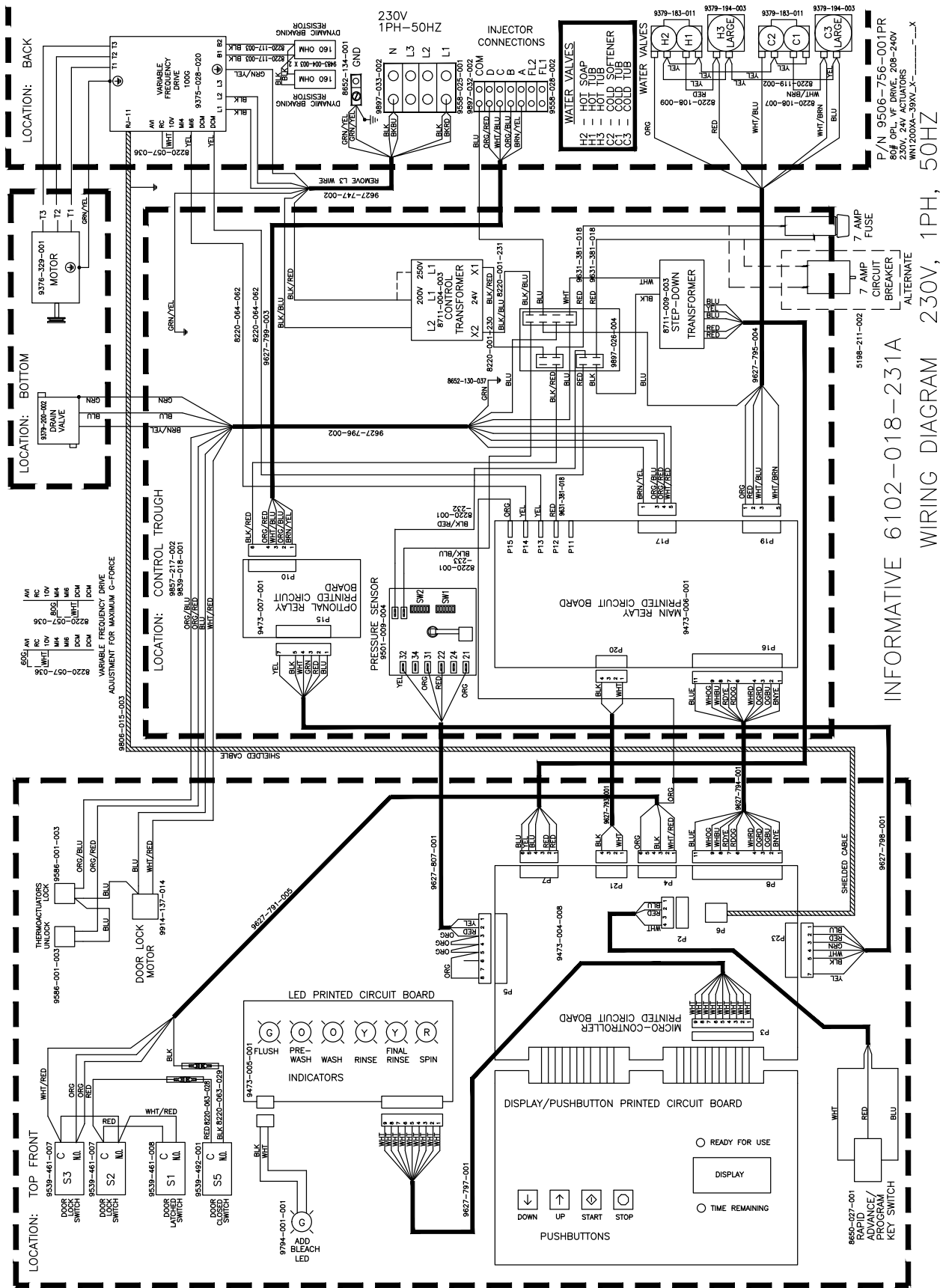

Section :10

Maintenance

Preventative Maintenance

Daily

- Step 1:** Clean the top and the cabinet to remove residue.
- Step 2:** Clean the soap dispenser and soap lid
- Step 3:** Check the drain for leaking and proper draining.
- Step 4:** Check the loading door for leaks.
- Step 5:** Clean the door seal of all foreign material.
- Step 6:** Leave the loading door open to aerate the washer when not in use.

Monthly

- Step 1:** Clean with dry and clean compressed air through optical coin acceptor to remove dust and lint.

Quarterly

Make sure the power is disconnected before making the following checks.

- Step 1:** Check the drive belt for wear and proper tension.
- Step 2:** Clean lint and other foreign material from around drive motor.
- Step 3:** Check all water connections for leaks.
- Step 4:** Wipe and clean the inside of the washer and check all electrical components for moisture and dust.
- Step 5:** Remove and clean water inlet hose filters. Replace if necessary.
- Step 6:** After any service always replace all panels before reconnecting electrical power.

Biannually

- Step 1:** Clean the fan on the bottom of the VFD with dry and clean compressed air.

Annually

- Step 1:** Inspect all wire connections for tightness
- Step 2:** Inspect and check the tightness of the mounting bolts securing the washer to base frame.

