

**INDUSTRIAL DRYER  
MODEL T-30, T-50, & T-80 ON-PREMISE  
B-SERIES CONTROL, NATURAL GAS/LP HEATED**

**Original Instructions  
For GB & IE**



**DEXTER.  
LAUNDRY**

**OPERATOR'S MANUAL  
INSTALLATION & OPERATION INSTRUCTIONS**

The dryer will operate correctly in ambient temperatures of +5°C to +45°C, in relative humidity up to 50% at +40°C and above 50% when below +40°C, and at altitudes up to 1000m above sea level, must be transported and stored from -40°C to +140°C, and has been packaged to prevent damage from humidity, vibration, and shock. Take measures to avoid harmful effects of occasional condensation.

**WARNING: For your safety the information in this manual must be followed to minimize the risk of fire or explosion or to prevent property damage, personal injury or death.**

**-Do not store or use petrol or other flammable vapours and liquids in the vicinity of this or any other appliance.**

**-WHAT TO DO IF YOU SMELL GAS**

**-Do not try to light any appliance.**

**-Do not touch any electrical switch: do not use any telephone in your building.**

**-Clear the room, building or area of all occupants.**

**-Immediately call your gas supplier from a neighbor's telephone. Follow the gas supplier's instructions.**

**-If you cannot reach your gas supplier, call the fire department.**

**Installation, service, and, if the need arises, conversion for use with other gases must be performed by a qualified installer, service agency or the gas supplier.**

You, the purchaser, must post in a prominent location instructions to be followed in the event the user smells gas. Consult your local gas supplier for procedure to be followed if the odour of gas is present.

Post the following **"For Your Safety"** cautions in a prominent location:

**FOR YOUR SAFETY**

Do not store or use petrol or other flammable vapours and liquids or dry cleaning solvents in the vicinity of this or any other appliance.

**FOR YOUR SAFETY**

**THIS MACHINE IS FOR DRYING ONLY FABRICS WASHED IN WATER.**

To avoid possibility of fire, including spontaneous combustion, do not dry oiled floor mops, items containing foam rubber or similarly textured rubberlike materials or any material on which you have used a cleaning solvent or which contains flammable liquids or solids (such as petrol, kerosene, waxes, etc.) Fabric softeners, or similar products, should be used per the fabric softener instructions. Remove all objects from pockets such as lighters and matches.

This appliance can be used by children aged from 8 years and above and persons with reduced physical, sensory or mental capabilities or lack of experience and knowledge if they have been given supervision or instruction concerning use of the appliance in a safe way and understand the hazards involved. Children shall not play with the appliance. Cleaning and user maintenance shall not be made by children without supervision. Children of less than 3 years should be kept away unless continuously supervised.



It is important that you read this Manual and retain it for future reference. For service or replacement parts, contact the distributor in your area or the manufacturer:

**Dexter Laundry, Inc.**  
2211 West Grimes Avenue  
Fairfield, Iowa 52556, USA

## TABLE OF CONTENTS

DRYER DIMENSIONS (Figure 1).....	4
UNCRATING.....	7
DRYER INSTALLATION.....	7
CONTROL TRANSFORMER CONNECTIONS (Figure 2).....	9
DRYER SHUTDOWN.....	14
TOUCH PAD LAYOUT (Figure 3).....	15
DRYER DEFAULT SETTINGS.....	16
DRYER FAULT CODES.....	16
TOUCH PAD DESCRIPTION.....	17
OPERATING INSTRUCTIONS.....	19
TEMPORARY DRYER CONTROLLER PROGRAMMING.....	21
PERMANENT DRYER CONTROLLER PROGRAMMING.....	24
SERVICING THE DRYER.....	27
PREVENTATIVE MAINTENANCE.....	28

## WARNINGS ABOUT USE AND OPERATION

 <p style="text-align: center;">Caution! There are sharp edges on various sheet metal parts internal to the enclosure. Use safety consciousness when placing or moving your hands while working in the interior of this equipment.</p>	
 <p>Meaning: Do Not Enter This Equipment (or Space).</p>	 <p>Meaning: Do Not Step, Stand, or Sit on This Equipment.</p>
 <p>Meaning: Do Not Operate with Guards or Covers Removed.</p>	 <p>Meaning: High Voltage. Disconnect power before servicing.</p>
 <p>Meaning: Lock Out and Tag Out before servicing.</p>	 <p>Meaning: Burn Hazard. Do Not Touch Burner Housing or Main Burners. Allow these parts to cool before servicing.</p>
 <p>Meaning: Do Not Dry Items Containing Explosive Material.</p>	 <p>Meaning: Do Not Dry Items Containing Flammable Material.</p>
 <p>Meaning: Read Operators Manual.</p>	 <p>Meaning: Center of Gravity.</p>
 <p>Meaning: Left Point for Forklift or Hand Pallet Truck or Jack.</p>	 <p>Meaning: Right Point for Forklift or Hand Pallet Truck or Jack.</p>

## WARNINGS ABOUT USE AND OPERATION **continued**

It is **ABSOLUTELY ESSENTIAL** that the dryer be connected to a good earth connection. This is not only for personal safety, but is necessary for proper operation.

**DO NOT MODIFY THIS APPLIANCE. KEEP SHIELDS, GUARDS AND COVERS IN PLACE.** These safety devices are provided to protect everyone from injury.





**WARNING:** Do not stop dryer before end of cycle time unless all items are quickly removed and spread out to dissipate heat.

**DO NOT SPRAY AEROSOLS IN THE VICINITY OF THIS APPLIANCE** while in operation.

**THIS APPLIANCE SHALL NOT BE USED TO DRY OFF CLOTHES CONTAINING SOLVENTS OR DRY-CLEANING FLUIDS.**

**THIS DRYER IS EQUIPPED WITH A MANUALLY RESETTABLE OVER-TEMPERATURE THERMOSTAT** located to the right of the motor on the rear of the cabinet. Should the dryer cease to operate, refer to your "Service Procedure and Parts Data" book for instructions.

**CHECK THIS THERMOSTAT WHEN INSTALLING DRYER** to assure it is not tripped. Impacts, such as rough handling in shipment, may trip the thermostat.

Misuse of Dryer	
	Do not use this Equipment for any purpose not described in this Manual.
	Do not operate this equipment without all guards and covers in place.
	Do not operate this dryer from any power source not matching the operational requirements on the back of the dryer.
	Do not place your body inside the dryer cylinder or allow others to do so. Death or serious injury can result from this!
Other Examples May Be Applicable	



### Caution – Replace Fuses With Same Type and Rating

Fuse No.	Voltage	Amperage	SC I/R	Type	Size
F1 in rear control box	250V	2.5A	100A@250VAC	F	¼ x 1¼" (6.35 x 31.75 mm)
F1 on front control	250V	600mA	35A@250VAC	T	5.00 x 20.00 mm

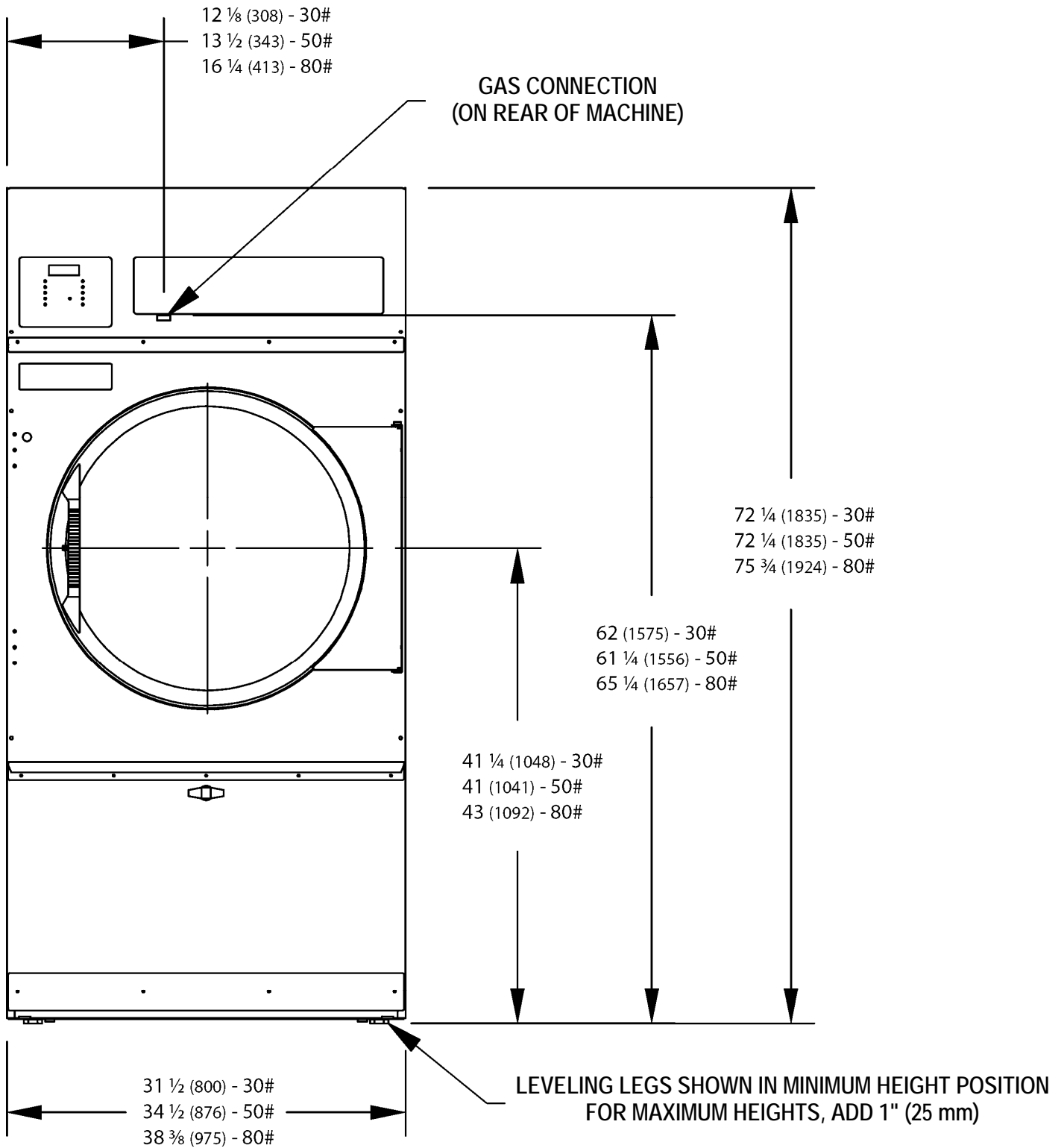

DRYER DIMENSIONS - FIGURE 1A

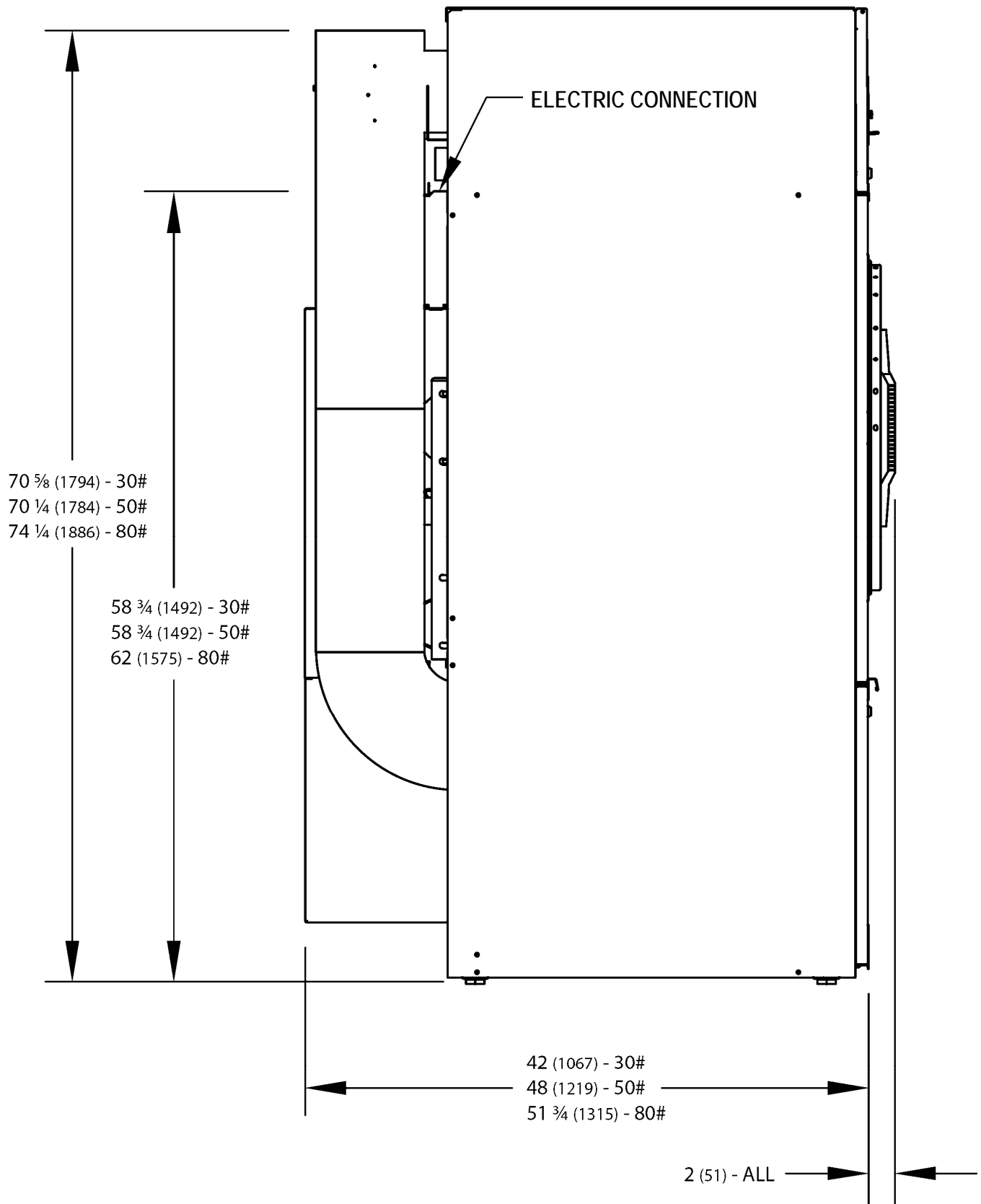

DRYER DIMENSIONS - FIGURE 1B

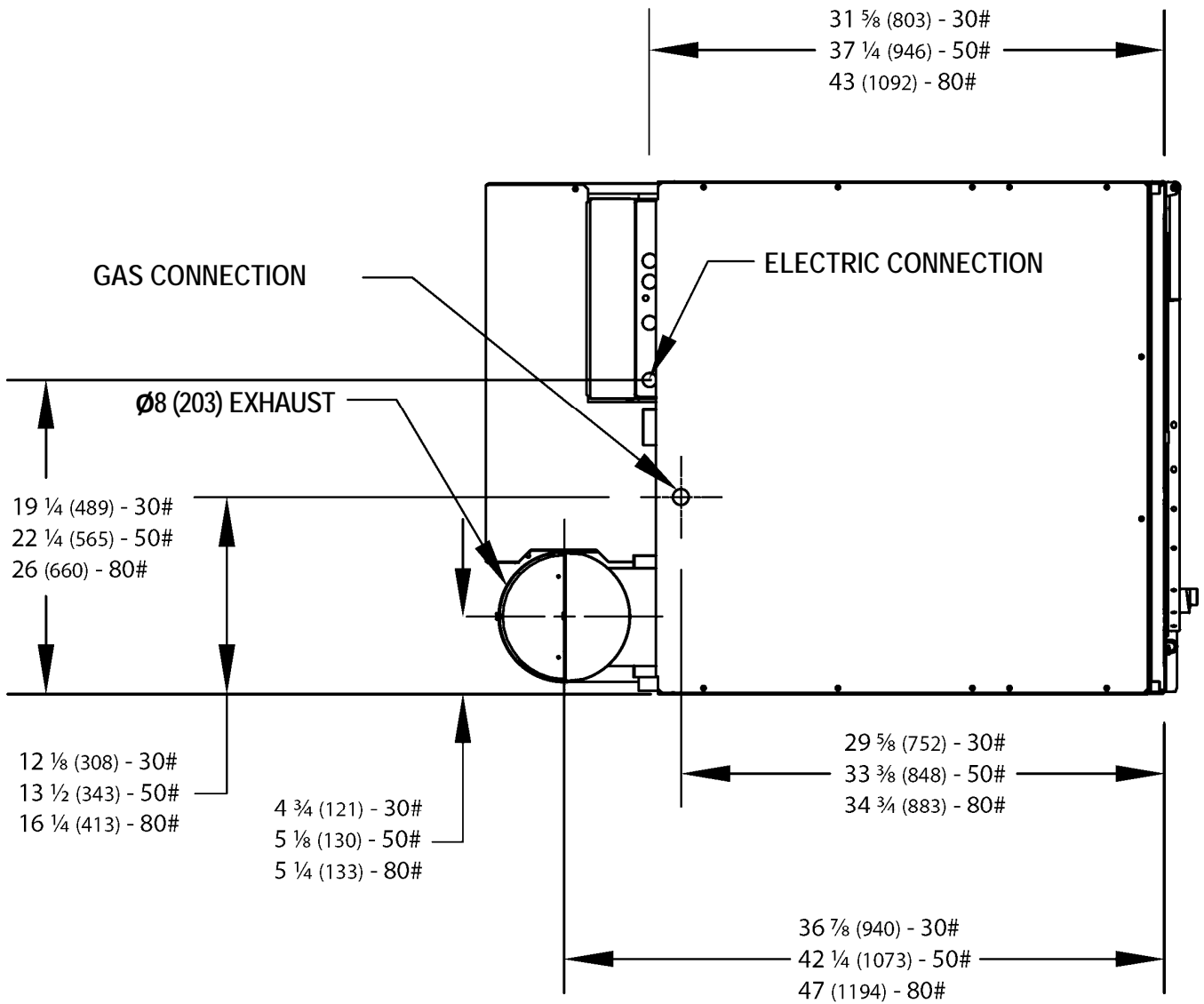

DRYER DIMENSIONS - FIGURE 1C

## INSTALLATION AND OPERATING INSTRUCTIONS

**Note: Before installation, check that the local distribution conditions, nature of gas and pressure, and the adjustment of the appliance are compatible.**

**Note: A forklift, or a hand pallet truck or jack, must lift the dryer and only from the front or rear of the dryer with the dryer bolted to the pallet and supported the full length of the dryer.**

### UNCRATING AND PLACING DRYER

Tools Required: 3/4" (19 mm) hex deep socket and ratchet driver, a knife, and a channel-lock wrench the opens to 1-3/8" (35 mm).

1. Remove the plastic wrap with the knife. Remove cardboard rails, fillers, and top cap.
2. Using a ratchet and a 3/4" (19 mm) socket, remove the (4) bolts attaching the pallet to the dryer cabinet. Save the bolts for future moving of the dryer.
3. With a walking motion, move the dryer forward completely off the pallet. Save the pallet for future moving of the dryer.
4. Using the channel-lock wrench, adjust the leveling legs to align the machine with adjacent units.

Note: If the dryer is ever moved again, the dryer should be re-mounted on its pallet and its crating bolts re-inserted and tightened, in the reverse order as above.

Dryer Model	Mass	Dryer Model	Mass	Dryer Model	Mass
DN0030N_-59	210 kg	DN0050N_-59	263 kg	DN0080N_-59	331 kg

### DRYER INSTALLATION

This appliance must be installed in accordance with the rules in force and used only in a sufficiently ventilated space. Consult instructions before installation of this appliance.

1. CODE CONFORMITY: All industrial dryer installations must conform to the local and national codes for the location of installation and ventilation requirements.

The appliance must not be installed behind a lockable door, a sliding door or a door with a hinge on the opposite side to that of the tumble dryer, in such a way that a full opening of the tumble dryer door is restricted.

2. INSTALLATION CLEARANCES: This unit may be installed at the following alcove clearance.

- I. Left Side 0"
- II. Right Side 0" \*
- III. Back 18" (457 mm) (Certified for 1" (25 mm) clearance; however, 18" (457 mm) clearance is necessary behind the belt guard to allow servicing and maintenance.
- IV. Front 48" (1200 mm) to allow use of dryer.
- V. Top Refer to figure on next page labeled "Vertical Clearance Dimensions". Certification allows 0" clearance at the top 1" (25 mm) back from the front. However, 1/4" (6 mm) clearance is required to allow opening the upper service door.  
A 10" (254 mm) clearance is required from top at all other points.
- VI. Floor This unit may be installed upon a combustible floor.

Do not obstruct the flow of combustion and ventilation air.

Maintain minimum of 1" (25) clearance between duct and combustible material.

Refer to installation label attached to rear guard for other installation information.

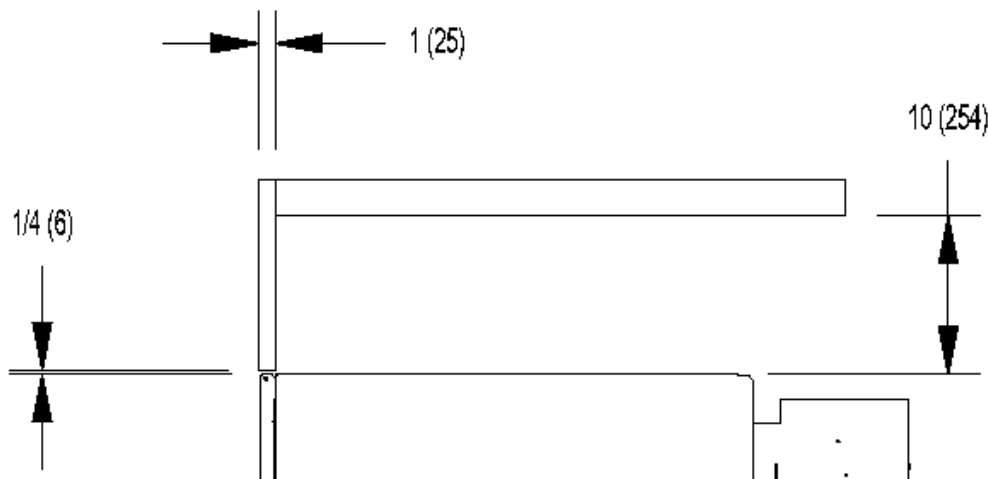

**VERTICAL CLEARANCE DIMENSIONS - ALL DN00(30/50/80)N\_-59**

3. MAKE-UP AIR. Adequate make-up air must be supplied to replace air exhausted by dryers on all types of installations. Provide a minimum make-up air opening to the outside for each dryer as follows:

Dryer Model	Make-up Air Volume/Time	Make-up Air Opening Size (minimum)
DN0030N_-59	690 CFM (19.5 m <sup>3</sup> /minute)	1 ft <sup>2</sup> (0.10 m <sup>2</sup> )
DN0050N_-59	700 CFM (19.8 m <sup>3</sup> /minute)	1.25 ft <sup>2</sup> (0.12 m <sup>2</sup> )
DN0080N_-59	850 CFM (24.1 m <sup>3</sup> /minute)	1.25 ft <sup>2</sup> (0.12 m <sup>2</sup> )

This is a net requirement of effective area. Screens, grills, or louvers, which will restrict the flow of air, must be considered. Consult the supplier to determine the free area equivalent for the grill being used.

The source of make-up air should be located sufficiently away from the dryers to allow an even airflow to the air intakes of all dryers. Multiple openings should be provided.

NOTE: The following considerations must be observed for gas dryer installations where dry cleaners are installed. The sources of all make-up air and room ventilation air movement to all dryers must be located away from any dry cleaners. This is necessary so that solvent vapours will not be drawn into the dryer inlet ducts. Dry cleaner solvent vapours will decompose in contact with open flame such as the gas flame present in clothes dryers. The decomposition products are highly corrosive and will cause damage to the dryer(s) ducts and clothes loads.

The operation of this appliance may affect the operation of other types of gas appliances, which take their air for safe combustion from the same room. Adequate ventilation must be provided to avoid back flow of gasses from other appliances in the same room. All other gas appliances should be tested with the Dexter dryer in operation and all the windows and doors closed. If in doubt consult the appliance manufacturer(s).

4. ELECTRICAL REQUIREMENTS.

The electrical installation must be performed by a qualified electrical technician.



The electrical power requirements necessary to operate the unit satisfactorily are listed on the serial plate located on the back panel of each dryer. The electrical connection should be made to the terminal board in the control box, on the rear of the unit using copper conductors of 15A minimum capacity. A 7/8" (22 mm) hole (plugged with a plastic plug) is provided for the connection of conduit for the power supply conductors. It is absolutely necessary that the dryer be connected to a good earth connection. The earth connection resistance should be checked prior to operation. Introduction of supply wiring must not increase the Ingress Protection (IP) rating.

The installation must meet the electrical requirements of the country, state, or locality of installation. Individual 10A circuit breakers for each dryer are required. The installer must provide a disconnect switch which will interrupt both lines. It may be a local or national requirement to provide an electrical interruption switch visible and accessible from the room in which the dryer is installed. The wiring diagram is located on the belt guard on the back of the dryer.

For destination countries where CE requirements must be met, individual 230V supply disconnecting devices for each dryer are required and must be one of the following types:

- switch-disconnector with fuses per IEC 60947-3 utilization category AC-23B;
- disconnecter with fuses per IEC 60947-3 having an auxiliary contact that in all cases causes switching devices to break the load circuit before the opening of the main contacts of the disconnecter;
- a circuit-breaker suitable for isolation per IEC 60947-2;
- any other switching device in accordance with an IEC product standard for that device and which meets the isolation requirements of IEC 60947-1 as well as a utilization category defined in the product standard as appropriate for on-load switching of motors or other inductive loads;

The supply disconnecting devices must

- provide a means allowing the supply disconnecting devices to be locked in the OFF position;
- be mounted 0.7 m to 1.7 m above the floor, within 2 m from the dryer, and within 8 m from the operator position;
- have a red actuator to indicate that it serves a dual Emergency Stop function;
- be rated for branch circuit operation;
- be approved for use in the country where installed;

Adjustment for different voltages of supply mains.

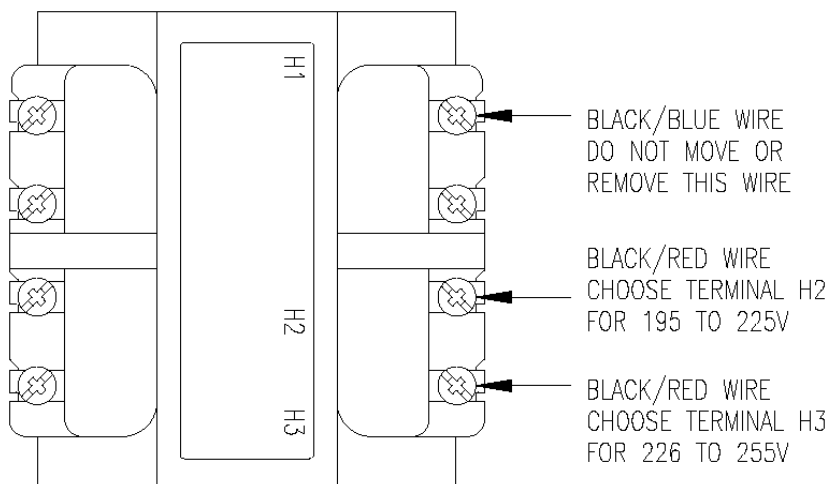

**Figure 2** CONTROL TRANSFORMER CONNECTIONS

## IMPORTANT: TRANSIENT VOLTAGE SURGE SUPPRESSORS

Like most electrical equipment your new machine can be damaged or have its life shortened by voltage surges due to lightening strikes which are not covered by factory warranty. Local power distribution problems also can be detrimental to the life of electrical components. We recommend the installation of transient voltage surge suppressors for your new equipment. These devices may be placed at the power supply panel for the complete installation and don't require an individual device for each machine.

These surge protectors help to protect equipment from large spikes and also from small ongoing spikes in the power that occur on a day to day basis. These smaller surges can shorten overall life of electrical components of all types and cause their failure at a later date. Although they can't protect against all events, these protective devices have a good reputation for significantly lengthening the useful life of electronic components. Electronic components are helped to have a longer useful life when they are supplied with the clean stable electrical power they like.

5. GAS REQUIREMENTS. The complete gas requirements necessary to operate the dryer satisfactorily are listed on the serial plate located on the back panel of the dryer.

This appliance is adjusted for a G20 gas supply; please refer to the table on the next page for country and regulator setting.

### NATURAL GAS FOR DN0030N\_-59

NOMINAL HEAT INPUT $Q_n$	74000 BTU/HR (23.5 kW) NET
GAS FLOW RATE	2.2 m <sup>3</sup> PER HOUR
BURNER PRESSURE	3.5 in. H <sub>2</sub> O (8.7 mbar) (0.87 kPa)
INJECTOR SIZE	NO. 32 DRILL (2.95 mm)

### NATURAL GAS FOR DN0050N\_-59

NOMINAL HEAT INPUT $Q_n$	120000 BTU/HR (35.2 kW) NET
GAS FLOW RATE	3.3 m <sup>3</sup> PER HOUR
BURNER PRESSURE	3.5 in. H <sub>2</sub> O (8.7 mbar) (0.87 kPa)
INJECTOR SIZE	NO. 32 DRILL (2.95 mm)

### NATURAL GAS FOR DN0080N\_-59

NOMINAL HEAT INPUT $Q_n$	195000 BTU/HR (52.8 kW) NET
GAS FLOW RATE	5.0 m <sup>3</sup> PER HOUR
BURNER PRESSURE	3.5 in. H <sub>2</sub> O (8.7 mbar) (0.87 kPa)
INJECTOR SIZE	NO. 30 DRILL (3.26 mm)

## ADJUSTMENT REQUIRED PER COUNTRY

COUNTRY	CATEGORY	SUPPLY PRESSURE mbar (Normal / Minimum / Maximum)	REGULATOR SETTING mbar (kPa) (Designation)
BG, LV	I 2H	(20 / 17 / 25)	8.7 (0.87) (G20)
HU	I 2H	(25 / 18 / 33)	8.7 (0.87) (G20)
LU	I 2E	(20 / 17 / 25)	8.7 (0.87) (G20)
CY, DK, EE, FI, HR, IT, LT, NO, RO, SE, SI, SK, TR	II 2H3B/P	(20 / 17 / 25) / (30 / 25 / 35)	8.7 (0.87) (G20) / 22.4 (2.24) (G30)
AT, CH, SK	II 2H3B/P	(20 / 17 / 25) / (50 / 42.5 / 57.5)	8.7 (0.87) (G20) / 22.4 (2.24) (G30)
CH, CZ, ES, GB, GR, HR, IE, IT, LT, PT, SI, SK	II 2H3P	(20 / 17 / 25) / (37 / 25 / 45)	8.7 (0.87) (G20) / 22.4 (2.24) (G31)
NL	II 2L3B/P	(25 / 20 / 30) / (30 / 25 / 35)	12.2 (1.22) (G25) / 22.4 (2.24) (G30)
RO	II 2L3B/P	(20 / 17 / 25) / (30 / 25 / 35)	12.2 (1.22) (G25) / 22.4 (2.24) (G30)
NL	II 2L3P	(25 / 20 / 30) / (37 / 25 / 45)	12.2 (1.22) (G25) / 22.4 (2.24) (G31)
NL	II 2L3P	(25 / 20 / 30) / (50 / 42.5 / 57.5)	12.2 (1.22) (G25) / 22.4 (2.24) (G31)
RO	II 2E3B/P	(20 / 17 / 25) / (30 / 25 / 35)	8.7 (0.87) (G20) / 22.4 (2.24) (G30)
PL	II 2E3B/P	(20 / 17 / 25) / (37 / 25 / 45)	8.7 (0.87) (G20) / 22.4 (2.24) (G30)
DE	II 2E3B/P	(20 / 17 / 25) / (50 / 42.5 / 57.5)	8.7 (0.87) (G20) / 22.4 (2.24) (G30)

The inlet gas connection to the unit is ISO 7-RC 3/4 thread. The connection to the appliance shall be made with a flexible hose suitable for the appliance category in accordance with national installation regulations. The size of the piping to supply the dryer should be determined by reference to national installation practice and consultation with the local gas supplier.

An individual gas shutoff valve is recommended for each dryer and may be required by regulation (not supplied).

A joint compound resistant to all fuel gases must be employed in making threaded pipe connections.

A drip tee should be provided in the unit gas piping to catch dirt and other foreign articles.

All pipe connections should be checked for leakage with soap solution. Never check with an open flame.

Note: There are two 9 mm pressure taps, one at the inlet side, and one at the outlet side of the gas valve, for use if it is necessary to check either pressure.

### **PRESSURE REGULATOR ADJUSTMENT**

**Adjustments should be made by qualified personnel only.**

1. With dryer off, unscrew the outlet pressure tap on the gas control valve a half turn and slip pressure gauge tube over nipple. Ensure that screw is retightened after the regulator is adjusted.

2. Remove regulator cap screw to expose regulator adjustment screw.
3. Start the dryer. Using a screwdriver, slowly turn the adjustment until the required burner pressure is indicated on the pressure gauge. Turn adjustment screw clockwise to increase and counter-clockwise to decrease gas pressure to burner. Turn dryer off.
4. Replace pressure regulator cap screw.
5. Remove pressure gauge and retighten pressure tap screw.

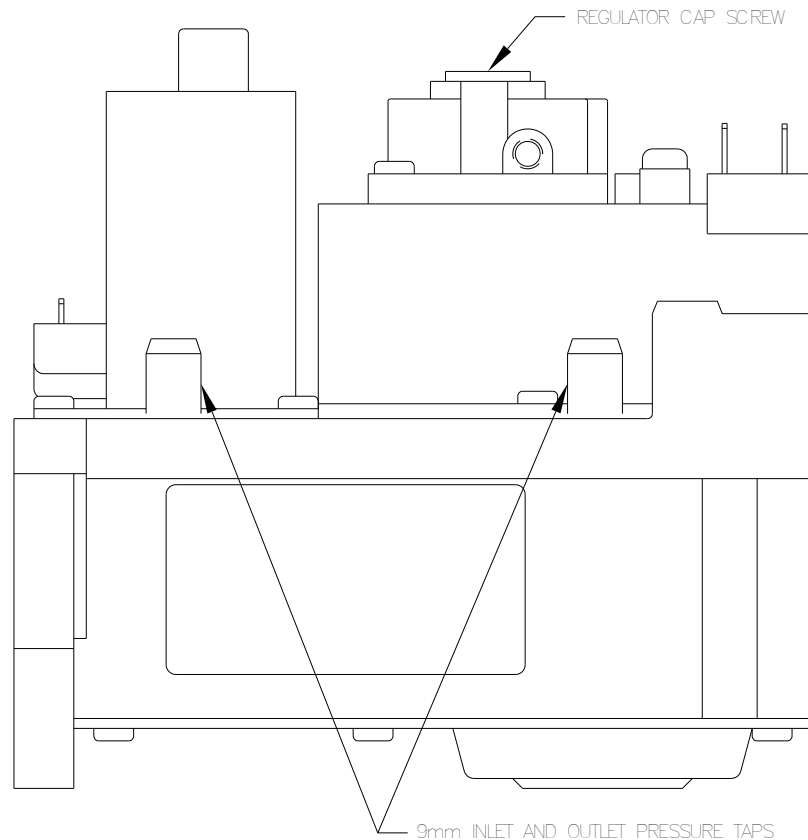

For altitudes above 2,000 feet (610 m), it is necessary to derate the BTU input. Contact your local distributor for instructions.

L.P. gas conversion kits are available for this dryer. Contact your local distributor.

**CAUTION:** The dryer must be disconnected from the gas supply piping system during any pressure testing of that system. Do not expose the dryer's gas control valve to testing pressure.

6. **EXHAUST INSTALLATION.** Exhausting of the dryer(s) should be planned and constructed so that no air restrictions occur. Any restriction due to pipe size or type of installation can cause slow drying time, excessive heat, and lint in the room.

From an operational standpoint, incorrect or inadequate exhausting can cause a cycling of the high limit thermostat, which shuts off the main burners and results in inefficient drying.

Individual exhausting of the dryers is required. All heat, moisture, and lint should be exhausted outside by attaching a pipe of the proper diameter to the dryer adapter collar and

extending it out through an outside wall. This pipe must be very smooth on the inside, as rough surfaces tend to collect lint, which will eventually clog the duct and prevent the dryer from exhausting properly. All elbows must be smooth on the inside. All joints must be made so the exhaust end of one pipe is inside the next one downstream. The addition of an exhaust pipe tends to reduce the amount of air the blower can exhaust. This does not affect the dryer operation if held within practical limits. For the most efficient operation, it is recommended that no more than 20' (6 m) of straight 8" (203 mm) diameter pipe be used with two right angle elbows. The design of the vent system shall be such that any condensate formed when operating the dryer from cold shall either be retained and re-evaporated or discharged.

Maintain a minimum of 25 mm (1 in.) clearance between duct and combustible material.

If the exhaust pipe passes through a wall, a metal sleeve of slightly larger diameter should be set in the wall and the exhaust pipe passed through this sleeve. This practice is required by some local codes and is recommended in all cases to protect the wall. This type of installation should have a means provided to prevent rain and high winds from entering the exhaust when the dryer is not in use. A hood with a hinged damper can be used for this purpose. Another method would be to point the outlet end of the pipe downward to prevent entrance of wind and rain. In either case, the outlet should be kept clear, by at least 24" (600 mm), of any objects, which would cause air restriction.

Never install a protective screen over the exhaust outlet.

When exhausting a dryer straight up through a roof, the overall length of the duct has the same limits as exhausting through a wall. A rain cap must be placed on top of the exhaust and must be of such a type as to be free from clogging. The type using a cone shaped "roof" over the pipe is suitable for this application.

Exhausting the dryer into a chimney or under a building is not permitted. The exhaust air should not be vented into a wall, a ceiling, or a concealed space of building. In these cases, there is a danger of lint buildup, which can be highly combustible.

**NOTE:** Exhaust air must not be discharged into a flue which is used for exhausting fumes from appliances burning gas or other fuels.

**WARNING** - A clothes dryer produces combustible lint and should be exhausted outdoors. The area around the clothes dryer should be kept free of lint.

7. DRYER IGNITION (SOLID STATE IGNITION): The solid-state ignition system lights the main burner gas by spark. The gas is ignited and burns only when the gas-relay (in the electronic controller) calls for heat. The procedure for first-time starting of a dryer is as follows.

- i. First review and comply with the "Warnings About Use and Operation" found on the inside front cover of this manual. Be sure electrical power is connected correctly. The dryer must be properly earthed.
- ii. Make sure all gas supply lines are purged of air. Close the main gas shut-off valve and wait for five minutes before turning it back on.

- iii. Turn on the main electrical power switch. The dryer may be started by following the "Operating Instructions" found later in this manual.
- iv. Natural gas and LPG fired dryers operate in the same manner. When the gas valve relay contacts are closed (indicating a demand for heat), the solid-state ignition control will automatically supply energy to the redundant gas valve after a 15 second pre-purge. Sparking will continue until a flame is detected by the sensing probe, but not longer than 4 seconds. If the gas fails to ignite in 4 seconds, the gas valve closes and the gas system will "lock out". No further attempts will be performed automatically. To reset the ignition control electrical power to the ignition control must be interrupted. This can be done by opening the dryer door (stopping the dryer) for 15 seconds. Closing the door and pushing the "Start" button will repeat the ignition trial cycle.

8. MAIN BURNER ADJUSTMENT. The primary air shutter of each main burner must be properly adjusted for the correct air-gas ratio. Loosen the shutter locking screw. Adjust the shutter by closing it sufficiently to give a blue flame with a yellow tip. Next, open the shutter until the yellow tips are at a minimum. After adjustment, securely lock each shutter in position by tightening the shutter locking screws.

NOTE: The A-weighted emission sound pressure level does not exceed 70dB(A). The operator does not need hearing protection.

NOTE: The dryer does not emit hazardous radiation.



**WARNING:** To avoid potential risks of spontaneous combustion of a load, remove the load quickly after the completion of the cycle or in case of failure of power supply.



**DANGER:** Do not dry loads which may create an explosive atmosphere in the dryer.

### **DRYER SHUTDOWN**

To render the dryer inoperative, turn off the main gas shut-off valve and disconnect electrical supply to the dryer.

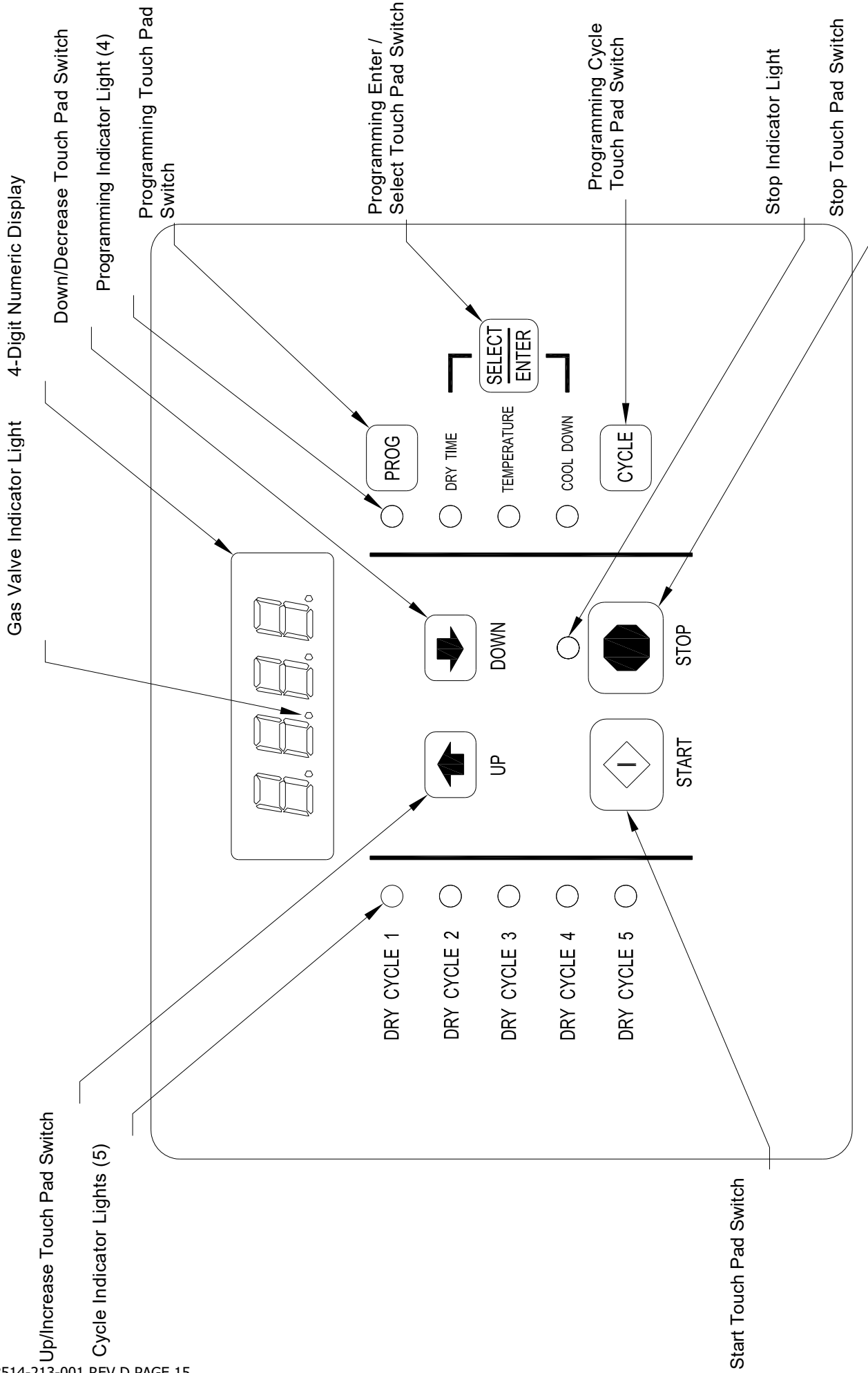

**Figure 3: Non-Reversing Dryer Controller Interface**

## **DRYER CONTROLLER FACTORY DEFAULT PROGRAM SETTINGS**

DRY CYCLE	COOL DOWN TIME (MINUTES)	TOTAL CYCLE TIME (MINUTES)	DRYING TEMPERATURE		DRYER LOAD
			(°F)	(°C)	
1	5	35	180	82	Towels, pads, heavy cotton
2	2	20	170	77	Sheets, blended materials
3	5	25	180	82	Cotton
4	2	20	130	54	Synthetic materials
5	2	25	175	79	Blended materials

## **DRYER FAULT CODES**

FAULT#	FAULT DESCRIPTION	ACTION
F1	Shorted thermostat sensor.	Dryer stops and "F1" flashes on the 4-digit display. When short circuit on sensor input is removed, "LOAd" appears on the 4-digit display and the remaining dry time is reset.
F2	Open thermostat sensor.	Dryer stops and "F2" flashes on the 4-digit display. When a good sensor is connected to sensor input, "LOAd" appears on the 4-digit display and the remaining dry time is reset.
F3	EEPROM corrupted.	Dryer will not start and "F3" appears on the 4-digit display. The power to the dryer must be cycled to reset the controller. Fault should only occur when starting a dry cycle.
F4	Gas valve on fault.	The drying temperature did not increase 1 <sup>0</sup> F. in 5 minutes. "F4" will flash on the display and the dry cycle will finish without calling for heat (energizing gas valve). Opening the door or pressing the STOP touch pad switch will reset the fault and clear the remaining time in the dry cycle.
F5	Temperature fault.	The drying temperature is at least 25 <sup>0</sup> F. above the temperature setting. "F5" will flash on the 4-digit display and the dry cycle will finish without calling for heat (energizing the gas valve). The power to the dryer must be cycled to reset the controller.



# TOUCH PAD DESCRIPTION

## INDICATOR LIGHTS (L.E.D.s)

### Description

Cycle (1 through 5)	These L.E.D.s are on solid when a particular cycle is chosen for operation or programming.
Gas Valve	This L.E.D. is part of the 4-digit numeric display and will be on solid during the drying part of a cycle when the gas valve does <u>not</u> need to be on. The L.E.D. will be blinking when the gas valve needs to be on. The L.E.D. will <u>not</u> be on solid or blinking (off) if the cycle is stopped, complete, in cool down, or terminated.
Programming	These L.E.D.s are on solid as they are selected during the programming of the dryer controller.
Stop	This L.E.D. is on solid when either the STOP button is pressed once or the door is opened during an operating cycle.

## SWITCHES (Pushbuttons)

### Description



UP  
Up/Increase

This touch pad switch will increment (increase) dry time, cool down time, and drying temperature. It will also scroll upwards when selecting a dry cycle.



DOWN  
Down/Decrease

This touch pad switch will decrement (decrease) dry time, cool down time and drying temperature. It will also scroll downwards when selecting a dry cycle.



Program

This touch pad switch allows the dryer controller to enter the permanent programming mode.



Select/Enter

This touch pad switch will select one of the three variable parts of the dry cycle (dry time, temperature, or cool down) by sequencing through them. Once one of the variable parts of the dry cycle is chosen and changed, this touch pad switch will enter the new (changed) value into the dry cycle program.



Cycle

This touch pad switch allows the dryer controller to enter the temporary programming mode.



STOP  
Stop

This touch pad switch will stop the dryer during a dry cycle without clearing the present drying cycle if pressed once. If pressed and released twice, consecutively, the present dry cycle will be cleared.

## SWITCHES (Pushbuttons) - continued

### Description



START

Start

This touch pad switch will start the operation of a dry cycle if pressed and released once. Pressing and holding this touch pad switch will display the current temperature of the dryer heat sensor as long as it is held in the depressed position.

## 4-DIGIT NUMERICAL DISPLAY MESSAGES

### Message

### Description

LOAD

This message is displayed after a dry cycle is complete and the dryer loading door has been opened or the **STOP** touch pad switch on the dryer controller has been pressed and released twice.

donE

This message blinks immediately after completion of the dry cycle and continues to blink until the **STOP** touch pad switch on the dryer controller is pressed or the dryer loading door is opened.

Prog

This message is displayed when entering the permanent programming mode.

.15

This message appears while the dryer is in the heating time of a dry cycle. The decimal point will blink if the output for the gas valve is on, or remain on constantly if the output for the gas valve is not on. The number represents the total time left in the dry cycle (includes cool down time).

C02

This message appears when the cool down time of the dry cycle is reached. The letter "C" represents the cool down (non-heating) part of the dry cycle. The number(s) after the letter "C" represent(s) the total time remaining in the dry cycle.

F5

This message appears if there is a dryer fault. The letter "F" indicates a fault and the number after the "F" represents the specific fault that has occurred. There are five different faults that can appear (F1 through F5).

## **OPERATING INSTRUCTIONS**

Maximum Load Capacity: 30 pounds (13.6 kg) Dry Weight for DN0030N\_-59

Maximum Load Capacity: 50 pounds (22.7 kg) Dry Weight for DN0050N\_-59

Maximum Load Capacity: 80 pounds (36.4 kg) Dry Weight for DN0080N\_-59

To dry a load of items, you must choose one of the five-programmed dry cycles. Each of these five dry cycles may be modified in two different ways to match your load. Please, refer to the "Permanent Dryer Controller Programming" or "Temporary Dryer Controller Programming" section of this manual.

There are two parts to each dry cycle. The first part is the heating time, which is when the gas valve is cycled on and off according to the temperature setting in the dry cycle program. The second part is the cool down time, which is after the heating part of the dry cycle, and is when the cylinder continues to turn, but no heat is applied to prevent damage from heat.

There will always be at least two minutes of cool down time for each dry cycle. The maximum amount of cool down time is 60 minutes if the controller has a red dot sticker or 15 minutes if the controller has no red dot sticker.

The five default dry cycle values are shown in the "DRYER CONTROLLER FACTORY DEFAULT PROGRAM SETTINGS" table in this manual.

To improve the drying capabilities of this dryer, you should always separate (untangle) the individual articles in your load before using the dryer.

In the following instruction steps, things that are displayed on the 4-digit numerical display will be in "quotation marks" and any touch pad switches on the dryer controller that physically need to be pressed will be in **CAPITAL AND BOLD LETTERS**.

- 1) Place your untangled load into the dryer cylinder and close the dryer loading door. Notice that the dryer controller 4-digit numerical display should show the word "LOAD". If it does not show this word, then press and release the **STOP** touch pad switch on the dryer controller twice.
- 2) Press and release the **UP** or **DOWN** touch pad switch on the dryer controller to select a dry cycle.
- 3) Once the desired dry cycle is selected, press and release the **START** touch pad switch.

After the dryer controller **START** touch pad switch is pressed, the dryer cylinder will start rotating and the two-digit total dry cycle time, along with a decimal point, will appear on the dryer controller display.

The time shown on the dryer controller display will count down to the programmed cool down time. At that time, the display will change from the decimal point and two-digit number to a letter "C" and two digits.

The letter "C" represents the cool down portion of the dry cycle. The two digits represent the amount of time remaining in the dry cycle. The two-digit time, shown on the dryer controller display, will count down to zero.

When the time decrements to zero, the dryer controller display will flash the word "donE" and the end of cycle tone will sound.

At that point, the wrinkle free cycle will automatically begin. This cycle will wait two minutes, if the door is not opened or the **STOP** touch pad switch on the dryer controller is not pressed, and then rotate the cylinder for 10 seconds and stop. These two minutes of idle time and 10 seconds of tumble time will repeat a total of 10 times, at which time the wrinkle free cycle stops. The cylinder will not rotate again until a new dry cycle is started.

During the wrinkle free cycle, the gas valve will not be operated and there will be no heat applied to the load. The word "donE" will also continue to flash and do so even after the wrinkle free cycle is finished. When the dryer loading door is opened, or the **STOP** touch pad switch is pressed, the word "donE" will change to the word "LOAD" on the dryer controller display. The dryer will then be ready for another dry cycle.

During the dry cycle, either pressing the **STOP** touch pad switch on the dryer controller or opening the dryer loading door, will stop the dry cycle and not clear it. If you press the **STOP** touch pad switch on the controller and then open the dryer loading door, the dry cycle will not be cleared. However, if you open (or open and close) the dryer loading door and then press the **STOP** touch pad switch on the dryer controller, the present dry cycle will be cleared and the word "LOAD" will appear on the dryer controller display.

There are two jumpers and one push button on the component side of the dryer controller printed circuit board.

The jumper located at the lower right of the circuit board controls whether the controller display shows and operates in the Fahrenheit or Celsius mode. This jumper is labeled as TEMP SELECT and has three pins. The bottom and middle pins are for Celsius and the top and middle pins are for Fahrenheit, which is indicated by the letter C for Celsius and the letter F for Fahrenheit.

The other jumper, located at the upper right side of the component side of the dryer controller circuit board, is used for choosing either a reversing or non-reversing type of dryer. This jumper is labeled as REV and NON-REV. This jumper must be in the non-reversing position, which are the bottom and middle pins. If the jumper is in the reversing position, the heating part of the dry cycle will not operate properly. The dryer will not reverse direction either.

The push button, which is located at the lower middle side of the component side of the dryer controller circuit board, is used to reset all five of the dry cycles to the factory default settings. It is labeled as DEFAULT SETTINGS. Even the dry cycles that have been modified using the permanent programming procedure will be changed back to the factory default settings when using this push button. This push button must be pressed and held for at least three seconds with power applied to the dryer controller circuit board.

If changing a jumper, remove power before moving jumper and then move jumper. Before restoring power, press and hold the DEFAULT SETTINGS pushbutton. Then, restore power and release the DEFAULT SETTINGS pushbutton after three seconds of restoring power.

## **TEMPORARY DRYER CONTROLLER PROGRAMMING**

The temporary programming mode will allow the change of the stored dry cycle settings in the dryer controller for one complete dry cycle. After the dry cycle is complete, the default settings that existed before the temporary change are restored. The temporary dry cycle can be stopped and cleared at any time during the dry cycle operation.

To temporarily change a dryer controller cycle, follow the procedures below. Things that are displayed on the 4-digit numeric display will be in "quotation marks". Touch pad switches on the dryer controller that physically need to be pressed will be in **CAPITAL AND BOLD LETTERS**.

If, at any time, you want to escape the temporary programming mode while changing the program settings, you can press the **STOP** touch pad switch on the dryer controller if the 4-digit numeric display is not flashing. The **SELECT/ENTER** touch pad switch on the dryer controller can be pressed and released to enter the flashing value shown on the 4-digit numeric display and allow you to escape.

If you press and release the **STOP** touch pad switch on the dryer controller, when the 4-digit numeric display is not flashing, the temporary changes to the dry cycle program will be cancelled. The stored dry cycle settings that existed before the temporary change will then be restored.

If, at any time, you want to start the temporary dry cycle during the temporary programming mode, press and release the **START** touch pad switch on the dryer controller if the 4-digit numeric display is not flashing. The **SELECT/ENTER** touch pad switch on the dryer controller can be pressed and released to enter the flashing value shown on the 4-digit numeric display and allow you to start the temporary dry cycle. If you start the temporary dry cycle, the 4-digit numerical display will change to the total dry time and count down to 0 as the dry cycle progresses.

---

### **PROCEDURE**

- 1) Make sure the dryer is not in a dry cycle. The 4-digit numeric display on the dryer controller will show "LOAD" when the dryer is not in a dry cycle.
- 2) Press and release the **UP** or **DOWN** touch pad switch on the dryer controller to choose the dry cycle that you want to change (dry cycle 1 through 5). The dry cycle L.E.D. will illuminate to indicate which dry cycle you are choosing. If you press either the **UP** or **DOWN** touch pad switch and hold it down, the controller will sequence through the five dry cycles.
- 3) Press and release the **CYCLE** touch pad switch on the dryer controller once you have chosen the dry cycle you want to change. After you press the **CYCLE** touch pad switch, the programming L.E.D. and the dry time L.E.D. will illuminate, the dry cycle L.E.D. will remain illuminated, and the total dry time will be displayed on the 4-digit numeric display.
- 4) Press and release the **UP** or **DOWN** touch pad switch on the dryer controller to change the total cycle time. Once either of the **UP** or **DOWN** touch pad switch is pressed, the dry

time L.E.D. and the total dry time on the 4-digit numeric display will flash. If you press and hold either the **UP** or **DOWN** touch pad switch, you will increment (**UP** arrow) or decrement (**DOWN** arrow) through the total dry times available (1 through 60 minutes). This displayed dry time includes the cool down time along with the heated time. To not change the total dry time, do not press either the **UP** or **DOWN** touch pad switch. Go to the next step.

- 5) Press and release the **SELECT/ENTER** touch pad switch on the dryer controller. Once the **SELECT/ENTER** touch pad switch is pressed and released, the dry time L.E.D. will switch off, the dry cycle L.E.D. and programming L.E.D. will remain on, the temperature L.E.D. will illuminate, and the drying temperature will be shown on the 4-digit numeric display.
- 6) Press and release the **UP** or **DOWN** touch pad switch on the dryer controller to change the drying temperature. Each press and release of the **UP** or **DOWN** touch pad switch will either increase or decrease, respectively, the temperature by five degrees Fahrenheit or three degrees Celsius, depending on how your dryer controller is set up. Once either the **UP** or **DOWN** touch pad switch is pressed, the temperature L.E.D. and the drying temperature on the 4-digit numeric display will flash. If you press and hold down either the **UP** or **DOWN** touch pad switch, you will increment (**UP** arrow) or decrement (**DOWN** arrow) your way through the available drying temperatures (105<sup>0</sup> Fahrenheit or 40<sup>0</sup> Celsius, up to 195<sup>0</sup> Fahrenheit or 91<sup>0</sup> Celsius). If you do not want to change the drying temperature, do not press either the **UP** or **DOWN** touch pad switch. Go to the next step.
- 7) Press and release the **SELECT/ENTER** touch pad switch on the dryer controller. Once the **SELECT/ENTER** touch pad switch is pressed and released, the temperature L.E.D. will switch off, the dry cycle L.E.D. and the programming L.E.D. will remain on, the cool down L.E.D. will illuminate, and the cool down time will be shown on the 4-digit numeric display.
- 8) Press and release the **UP** or **DOWN** touch pad switch on the dryer controller to change the cool down time. Once either the **UP** or **DOWN** touch pad switch is pressed, the cool down L.E.D. and the cool down time on the 4-digit numeric display will flash. If you press and hold down either the **UP** or **DOWN** touch pad switch, you will increment (**UP** arrow) or decrement (**DOWN** arrow) through the cool down times available (2 through 60 minutes if the controller has a red dot sticker or 2 through 15 minutes if the controller has no red dot sticker). To not change the cool down time, do not press either the **UP** or **DOWN** touch pad switch. Go to the next step.
- 9) Press and release the **SELECT/ENTER** touch pad switch on the dryer controller. Once the **SELECT/ENTER** touch pad switch is pressed and released, the cool down L.E.D. and the programming L.E.D. will switch off, the dry cycle L.E.D. will remain on, and the flashing cool down time on the 4-digit display will stop flashing and remain.
- 10) At this point, you have two choices.
  - a. You can perform the modified dry cycle by pressing and releasing the **START** touch pad switch on the dryer controller. If you start the modified cycle, the total dry time will appear on the 4-digit numeric display and it will count down to 0 as the dry cycle progresses.
  - b. You can clear the modified dry cycle program by pressing and releasing the **STOP** touch pad switch on the dryer controller once. If you choose to clear the modified dry cycle, the 4-digit numeric display will change to "LOAd".

## **TEMPORARY DRYER CONTROLLER PROGRAMMING EXAMPLE**

REQUIREMENTS: Dry a load with 40 minutes of actual heat at 185 °F and five minutes of cool down.

The following procedure will show you how to temporarily modify the existing dry cycle 1 program for one cycle of drying. It is based on the assumption that the factory defaults have not been permanently changed. If they have been changed, the steps of this procedure will be the same, but the values that are displayed will be different. The amount of times that the **UP** or **DOWN** touch pad switch on the dryer controller must be pressed and released may also be different.

If you want the change to be permanent, go to the "PERMANENT DRYER CONTROLLER PROGRAMMING" section of this manual.

### **PROCEDURE**

- 1) After the load has been placed in the dryer, press and release either the **UP** or **DOWN** touch pad switch on the dryer controller until the L.E.D. for dry cycle 1 is illuminated.
- 2) Press and release the **CYCLE** touch pad switch on the dryer controller. You will see the number "35" on the dryer controller display. The programming L.E.D. and dry time L.E.D. will be illuminated.
- 3) Press and release the **UP** touch pad switch on the dryer controller 10 times so the display will show a flashing "45". When the **UP** touch pad switch is pressed the first time, the number "36" will be flashing on the dryer controller display. Each number after that will also flash.
- 4) Now, press and release the **SELECT/ENTER** touch pad switch on the dryer controller. The number "45" will stop flashing and the dry time L.E.D. will switch off. The dryer controller display will now show "180", the temperature L.E.D. will illuminate, and the programming L.E.D. and dry cycle 1 L.E.D. will remain on.
- 5) Press and release the **UP** touch pad switch on the dryer controller 1 time so the controller display will show a flashing "185". Each press of the **UP** touch pad switch will increment the temperature by five degrees.
- 6) Now, press and release the **SELECT/ENTER** touch pad switch on the dryer controller. The number "185" will stop flashing and the temperature L.E.D. will switch off, the dryer control display will show a number "5", the cool down L.E.D. will illuminate, and the programming L.E.D. and dry cycle 1 L.E.D. will remain on.
- 7) Press and release the **SELECT/ENTER** touch pad switch on the dryer controller, since the desired cool down time is five minutes. After you press the **SELECT/ENTER** touch pad switch on the controller, the cool down L.E.D. and the programming L.E.D. will switch off, the controller display will remain at "5", and the dry cycle 1 L.E.D. will remain on.

You are now ready to start the new dry cycle. This new dry cycle will be in effect for one dry cycle only. After the dry cycle is done, or if the **STOP** touch pad switch on the dryer controller is pressed and released twice, consecutively, the dry cycle 1 program will revert to

the factory default settings.

If you press the **START** touch pad switch on the dryer controller, the controller display will change from the number "5" to the number "45" and dry cycle 1 will begin.

## **PERMANENT DRYER CONTROLLER PROGRAMMING**

The permanent programming mode will allow the change of the stored dry cycle settings in the dryer controller until the operator physically changes them again. The factory default settings can be restored in the dryer controller by pressing the default settings pushbutton on the back (component) side of the dryer controller circuit board. It is labeled and located at the lower middle side of the printed circuit board, as you face the component side of the board. It must be pressed and held down for at least three seconds during power up.

To permanently change a dryer controller cycle, follow the procedure below. Things that are displayed on the 4-digit numeric display will be in "quotation marks". Touch pad switches of the dryer controller that physically need to be pressed will be in **CAPITAL AND BOLD LETTERS**.

If, at any time, you want to escape the permanent programming mode while changing the settings, you can press the **STOP** touch pad switch on the dryer controller if the 4-digit numeric display is not flashing. The **SELECT/ENTER** touch pad switch on the dryer controller can be pressed and released to enter the flashing value shown on the 4-digit numeric display and allow you to escape.

---

### **PROCEDURE**

- 1) Make sure the dryer is not in a dry cycle. The 4-digit numeric display on the dryer controller will show "LOAD" when the dryer is not in a dry cycle.
- 2) Press and release the **PROG** touch pad switch on the dryer controller.
- 3) Press and release the **UP** touch pad switch on the dryer controller. The programming L.E.D. will illuminate and the 4-digit numeric display on the dryer controller will change to "Prog".
- 4) Press and release either the **UP** or **DOWN** touch pad switch on the dryer controller to choose the dry cycle you want to change (dry cycle 1 through 5). The dry cycle L.E.D. will illuminate to indicate which dry cycle you are choosing. If you press and hold down either the **UP** or **DOWN** touch pad switch, the controller will sequence through the five dry cycles.
- 5) Press and release the **SELECT/ENTER** touch pad switch on the dryer controller when you have chosen the dry cycle you want to change. After you press the **SELECT/ENTER** touch pad switch, the dry time L.E.D. will illuminate, the dry cycle L.E.D. and the programming L.E.D. will remain illuminated, and the total dry time will be displayed on the 4-digit numeric display.
- 6) Press and release either the **UP** or **DOWN** touch pad switch on the dryer controller to change the total dry time. Once either the **UP** or **DOWN** touch pad switch is pressed, the



dry time L.E.D. and the total dry time on the 4-digit numeric display will flash. If you press and hold down either the **UP** or **DOWN** touch pad switch, you will increment (**UP** arrow) or decrement (**DOWN** arrow) through the total dry times available (1 through 60 minutes). This displayed dry time includes the cool down time along with the heated time. To not change the total dry time, do not press either the **UP** or **DOWN** touch pad switch. Go to the next step.

- 7) Press and release the **SELECT/ENTER** touch pad switch on the dryer controller. Once the **SELECT/ENTER** touch pad switch is pressed and released, the dry time L.E.D. will switch off, the dry cycle L.E.D. and the programming L.E.D. will remain on, the temperature L.E.D. will illuminate, and the drying temperature will be shown on the 4-digit numeric display.
- 8) Press and release either the **UP** or **DOWN** touch pad switch on the dryer controller to change the drying temperature. Each press and release of either the **UP** or **DOWN** touch pad switch will either increase or decrease, respectively, the temperature by five degrees Fahrenheit or three degrees Celsius, depending on how your dryer controller is set up. Once either the **UP** or **DOWN** touch pad switch is pressed, the temperature L.E.D. and the drying temperature on the 4-digit numeric display will flash. If you press and hold down either the **UP** or **DOWN** touch pad switch, you will increment (**UP** arrow) or decrement (**DOWN** arrow) your way through the available drying temperatures (105<sup>o</sup> Fahrenheit or 40<sup>o</sup> Celsius, up to 195<sup>o</sup> Fahrenheit or 91<sup>o</sup> Celsius). If you do not want to change the drying temperature, do not press either the **UP** or **DOWN** touch pad switch. Go to the next step.
- 9) Press and release the **SELECT/ENTER** touch pad switch on the dryer controller. Once the **SELECT/ENTER** touch pad switch is pressed and released, the temperature L.E.D. will switch off, the dry cycle L.E.D. and programming L.E.D. will remain on, the cool down L.E.D. will illuminate, and the cool down time will be shown on the 4-digit numeric display.
- 10) Press and release either the **UP** or **DOWN** touch pad switch on the dryer controller to change the cool down time. Once either the **UP** or **DOWN** touch pad switch is pressed, the cool down L.E.D. and the cool down time on the 4-digit numeric display will flash. If you press and hold down either the **UP** or **DOWN** touch pad switch, you will increment (**UP** arrow) or decrement (**DOWN** arrow) through the cool down times available (2 through 60 minutes if the controller has a red dot sticker or 2 through 15 minutes if the controller has no red dot sticker). To not change the cool down time, do not press either the **UP** or **DOWN** touch pad switch. Go to the next step.
- 11) Press and release the **SELECT/ENTER** touch pad switch on the dryer controller. Once the **SELECT/ENTER** touch pad switch is pressed and released, the cool down L.E.D. will switch off, the dry cycle L.E.D. and the programming L.E.D. will remain on, and the 4-digit numeric display will change to "Prog".
- 12) Press and release the **STOP** touch pad switch on the dryer controller to save the cycle program and escape the programming mode. If you want to change the same dry cycle program again, press the **SELECT/ENTER** touch pad switch on the dryer controller and continue at step 6 of this procedure. If you want to modify another dry cycle program, go to step 4 of this procedure and continue.
- 13) If you pressed the **STOP** touch pad switch on the dryer controller to escape the

programming mode, you may now start the dry cycle by pressing the **START** touch pad switch on the dryer controller.

## **PERMANENT DRYER CONTROLLER PROGRAMMING EXAMPLE**

REQUIREMENTS: Dry a load with 50 minutes of actual heat at 195<sup>0</sup> F and three minutes of cool down.

The following procedure will show you how to permanently modify the existing dry cycle 1 program for one cycle of drying. It is based on the assumption that the factory defaults have not been permanently changed. If they have been changed, the steps of this procedure will be the same, but the values that are displayed will be different. The amount of times that the **UP** or **DOWN** touch pad switch on the dryer controller must be pressed and released may also be different.

If you want the change to be temporary (for only one dry cycle), go to the "TEMPORARY DRYER CONTROLLER PROGRAMMING" section of this manual.

### **PROCEDURE**

- 1) After the load has been placed in the dryer, press and release the **UP** or **DOWN** touch pad switch on the dryer controller until the L.E.D. for dry cycle 1 is illuminated.
- 2) Press and release the **PROG** touch pad switch on the dryer controller. The dryer controller display will not change.
- 3) Immediately, press and release the **UP** touch pad switch on the dryer controller. The controller display will change from "LOAD" to "Prog". You have now entered the permanent programming mode. The dry time L.E.D. will remain on and the programming L.E.D. will illuminate.
- 4) Press and release the **SELECT/ENTER** touch pad switch on the dryer controller once. The dry time L.E.D. and programming L.E.D. will remain on, the dry time L.E.D. will illuminate, and the dryer controller will show the number "35".
- 5) Press the **UP** touch pad switch on the dryer controller 18 times until the dryer controller display shows the number "53".
- 6) Press and release the **SELECT/ENTER** touch pad switch on the dryer controller once. The dry time L.E.D. and programming L.E.D. will remain on, the dry time L.E.D. will switch off, the temperature L.E.D. will illuminate, and the dryer controller display will show the number "180".
- 7) Press and release the **UP** touch pad switch on the dryer controller three times until the dryer controller display shows the number "195".
- 8) Press and release the **SELECT/ENTER** touch pad switch on the dryer controller. The dry time L.E.D. and the programming L.E.D. will remain on, the temperature L.E.D. will switch off, the cool down L.E.D. will illuminate, and the dryer controller display will show the number "5".

- 9) Press and release the **DOWN** touch pad switch on the dryer controller twice until the dryer controller display shows the number "3".
- 10) Press and release the **SELECT/ENTER** touch pad switch on the dryer controller. The dry time L.E.D. and the programming L.E.D. will remain on, the cool down L.E.D. will switch off, and the dryer controller display will change to "Prog".
- 11) Press and release the **STOP** touch pad switch on the dryer controller. The dry time L.E.D. will remain on, the programming L.E.D. will switch off, and the dryer controller display will change to the word "LOAD".

The dryer is now ready for the new modified dry cycle to start. This modified dry cycle 1 program will remain in the dryer controller memory until the default settings push button is pressed. This default settings push button is located on the component side of the dryer controller printed circuit board at the lower middle side.

### **SERVICING THE DRYER**

A flexible rod supports the upper service door by moving the end of this flexible rod against the burner enclosure. Chain links support the lower service door and both are detachable from the dryer, for wider access to the lint screen compartment, without any tools.

Before performing any maintenance on the dryer other than cleaning the lint screen, disconnect the electrical supply to the dryer.

## **SERVICING AND TROUBLESHOOTING**

CAUTION: Label all wires prior to disconnection when servicing controls. Wiring errors can cause improper and dangerous operation. Verify proper operation after servicing.

IMPORTANT: Clothes should be removed from the dryer as soon as possible after the cycle is completed and then folded or hung to prevent excessive wrinkling.

If any of the following symptoms occur on this dryer, check the suggested remedies listed below. If all probable causes have been eliminated and the symptom still exists, contact your local Dexter agent for further troubleshooting assistance. See contact information in Preventative Maintenance section. Parts & Service Manuals from Dexter are also available for further troubleshooting assistance.

<b>Symptom</b>	<b>Probable Cause</b>	<b>Suggested Remedy</b>
Tumbler Does not turn	Control	Check that Control Display shows time available for drying.
	Loading Door	Check that Loading Door is completely closed
	Lint Compartment Door	Check that Lint Compartment Door is completely closed.
	Drive Belts	Check drive belts for excessive wear. Replace as needed.
Tumbler Turns, but no burner flame is present	Gas shut-off valve	Make sure gas shut-off valve is in the open position
	Ignition Module	Follow the procedure for checking the ignition cycle listed in Dryer Ignition section of this manual.
Slow Drying	Control	Check that proper Temperature setting is chosen.
	Lint Screen	Clean Lint Screen
	Air flow Restrictions/ Make-up Air	Follow installation guidelines for static back pressure and make-up air
	Exhaust	Check exhaust for obstructions, follow installation guidelines

## **PREVENTIVE MAINTENANCE INSTRUCTIONS**

Note: A key with markings "6101" is provided for service access to the lint screen by a qualified person. This key should be stored in a secure place away from the dryer.

## PREVENTIVE MAINTENANCE INSTRUCTIONS

### DAILY (WARNING: Do not operate the dryer without the lint screen in place.)

Use service key to gain access to the lint screen compartment.

1. Clean the lint screen. Use a soft brush if necessary.
2. Check the lint screen for tears. Replace if necessary.
3. Clean lint from the lint screen compartment. Properly dispose lint according to area procedures.

Relock lower service door to prevent unauthorized access.

### MONTHLY

1. Remove lint accumulation from the end bells of the motor.
2. Remove lint accumulation from front control area.
3. Remove lint and dirt accumulation from the top of the dryer and all areas above, below, and around the burners and burner housing. Failure to keep this portion of the dryer clean can lead to a build-up of lint creating a fire hazard.
4. Place a few drops of general purpose lubricating oil on the clothes door hinge.
5. Grease the bearings and the shaft of the intermediate drive pulley. Use an Alemite grease gun and Molykote BR2-S grease and wear safety glasses.

### QUARTERLY

1. Check the belts for looseness, wear, or fraying.
2. Inspect the gasket of the door glass for excessive wear.
3. Check tightness of all fasteners holding parts to support channel.
4. Check tightness of all set screws.
5. Inspect the impeller for tightness of the blades to hub.
6. Check the tightness of the tumbler shaft retaining bolt.
7. Remove the air flow switch assembly and check the tumbler thru-bolts for tightness.
8. Remove lint accumulation from the primary air ports in the burners.
9. Apply general purpose lubricating oil to each spacer tube on the tension arm assembly.
10. Apply general purpose grease to pivot pins and tension arms where in contact with each other.

### SEMI-ANNUALLY

1. Remove and clean the main burners.
2. Remove all orifices and examine for dirt and hole obstruction.
3. Remove all lint accumulation. Remove the front panel and the lint screen housing to remove lint.
4. Check operation of tumbler door switch (S2). See below procedure\*.

### ANNUALLY

1. Check the intermediate pulley bearings for wear.
2. Check and remove any lint accumulation from the exhaust system.
3. Check operation of lower service door switch (S6). See below procedure\*.

\* Procedure for checking switch operation: Start dry cycle with door closed. During dry cycle, open door. If tumbler stops rotating, switch is good. If tumbler keeps rotating, switch is bad.

### SERVICE PARTS

### PART NUMBER

	<b>DN0030N_-59</b>	<b>DN0050N_-59</b>	<b>DN0080N_-59</b>
DRIVE BELT, MOTOR	9040-076-003	9040-076-006	9040-076-011
DRIVE BELT, TUMBLER	9040-073-009	9040-073-011	9040-073-012
LINT FILTER	9822-026-002	9822-026-001	9822-031-002
SERVICE MANUAL	8533-076-001	8533-076-001	8533-076-001

For service and parts information, contact your local Dexter agent. If a Dexter agent is not available, contact **Dexter Laundry, Inc.** directly as listed below:

Mailing Address: 2211 West Grimes Avenue Phone: 1-800-524-2954  
Fairfield, IA 52556  
USA

Website: [www.dexter.com/](http://www.dexter.com/)

DOW CORNING -- MOLYKOTE BR2-S GREASE -- 9150-00K000170

=====  
Product Identification  
=====

Product ID: MOLYKOTE BR2-S GREASE MSDS Date: 01/01/1985 FSC: 9150  
NIIN: 00K000170 MSDS Number: BBZKN

=====  
Responsible Party  
=====

Company Name: DOW CORNING Emergency Phone Number: 517-496-5900  
CAGE: 5D028

=====  
Contractor Identification  
=====

Company Name: DOW CORNING CORP Address: 3901 S SAGINAW RD Box: 997  
City: MIDLAND State: MI ZIP: 48686-0997 Country: US  
Phone: 517-496-6000/517-496-6315 CAGE: 5D028  
Company Name: DOW CORNING CORP Address: 2200 W SALZBURG RD Box:  
City: AUBURN State: MI ZIP: 48611 Country: US Phone: 517-496-4388  
CAGE: 71984

=====  
Composition / Information on Ingredients  
=====

Ingredient Name: LITHIUM SOAP Fraction by Weight: 5%  
Ingredient Name: MINERAL OIL (EXPOSURE REGULATED AS 'OIL MIST') CAS: 8012-95-1 RTECS #:  
PY8030000 Fraction by Weight: >90% OSHA PEL: 5 MG/M3 ACGIH TLV: 5 MG/M3/10 STEL;  
9192 Ingredient Name: ORGANIC LEAD Fraction by Weight: <1%

=====  
Hazards Identification  
=====

Effects of Overexposure: IRRITATES EYES

=====  
First Aid Measures  
=====

First Aid: FLUSH W/WATER

=====  
Fire Fighting Measures  
=====

Flash Point: >250 F OC Extinguishing Media: CARBON DIOXIDE OR FOAM  
Fire Fighting Procedures: NONE Unusual Fire/Explosion Hazard: NONE

=====  
Accidental Release Measures  
=====

Spill Release Procedures: MOP, WIPE OR SOAK UP WITH ABSORBENT MATERIAL

=====  
Handling and Storage  
=====

Handling and Storage Precautions: NOTHING SPECIAL

=====  
Exposure Controls/Personal Protection  
=====

Respiratory Protection: NOT NEEDED Ventilation: GENERAL MECHANICAL RECOMMENDED  
Protective Gloves: NOT NEEDED Eye Protection: SAFETY GLASSES  
Other Protective Equipment: AS REQUIRED

Supplemental Safety and Health MFR STATED THAT PRODUCT IS OBSOLETE.

=====  
Physical/Chemical Properties  
=====

HCC: V6 Boiling Point: B.P. Text: >300 F Vapor Pressure: <5 Spec Gravity: 0.9  
Evaporation Rate & Reference: <1, ETHER Solubility in Water : > 0.1 %  
Appearance and Odor: PASTE-LIKE, VERY LITTLE ODOR Percent Volatiles by Volume: <5

=====  
Stability and Reactivity Data  
=====

Stability Indicator/Materials to Avoid: YES NONE KNOWN  
Hazardous Decomposition Products: MOLYBDENUM & LITHIUM PROD, CO\*2, TRACES OF INCOMP  
BURNED CARBN

=====  
Disposal Considerations  
=====

Waste Disposal Methods: CAN BE LANDFILLED OR BURNED IN ACCORDANCE WITH LOCAL  
REGULATIONS.

Disclaimer (provided with this information by the compiling agencies): This information is formulated for use by elements of the Department of Defense. The United States of America in no manner whatsoever, expressly or implied, warrants this information to be accurate and disclaims all liability for its use. Any person utilizing this document should seek competent professional advice to verify and assume responsibility for the suitability of this information to their particular situation.



**EC DECLARATION OF CONFORMITY  
WITH COUNCIL DIRECTIVE 2006/42/EC**

Directive:	Machinery Directive on machinery safety, 2006/42/EC	
Conforming Machinery:	Industrial Drying System Model Numbers: DN30X2N, DN50X2N, DN0030N, DN0050N, DN0080N, DN0120N, DNS030N, DNS050N Serial Numbers:	
Manufacturer:	Dexter Laundry, Inc. 2211 West Grimes Avenue Fairfield, IA 52556 USA	
Harmonised Standards Referenced or Applied:	EN ISO 12100:2010	Safety of machinery. General principles for design. Risk assessment and risk reduction.
	EN 349:1993+A1:2008	Safety of machinery. Minimum gaps to avoid crushing of parts of the human body.
	EN 614-1:2006+A1:2009	Safety of machinery. Ergonomic design principles. Terminology and general principles.
	EN 953:1997+A1:2009	Safety of machinery. Guards. General requirements for the design and construction of fixed and movable guards.
	EN 1037:1995+A1:2008	Safety of machinery. Prevention of unexpected start-up.
	EN ISO 13857:2008	Safety of machinery. Safety distances to prevent hazard zones being reached by upper and lower limbs.
	EN ISO 14119:2013	Safety of Machinery. Interlocking devices associated with guards. Principles for design and selection.
	EN ISO 10472-1:2008	Safety requirements for industrial laundry machinery. Common requirements.
	EN ISO 10472-4:2008	Safety requirements for industrial laundry machinery. Air Dryers.
	EN 60335-1:2012/AC:2014	Safety of machinery. Electrical equipment of machines. General requirements.
Specifications with which Conformity is Declared:	Essential Health and Safety Requirements of Annex1 of the Machinery Directive	
We hereby certify that the machinery described above conforms with the essential health and safety requirements of Council Directive 2006/42/EC on the approximation of the laws of the Member States relating to the safety of machinery.		
Date:		
Signed:		
Signatory:	Mark Cox Director of Engineering	





<b>EC DECLARATION OF CONFORMITY WITH COUNCIL DIRECTIVE 2004/108/EC</b>		
Directive:	Electromagnetic Compatibility Directive 2004/108/EC	
Conforming Machinery:	Industrial Drying System Model Numbers: DN30X2N, DN50X2N, DN0030N, DN0050N, DN0080N, DN0120N, DNS030N, DNS050N	
Manufacturer:	Dexter Laundry, Inc. 2211 West Grimes Avenue Fairfield, IA 52556 USA	
Harmonised Standards Referenced or Applied:	EN 55014-1:2006/A2:2011 CISPR 14-1:2005/A2:2011	Electromagnetic compatibility. Requirements for household appliances, electric tools and similar apparatus. Emission.
	EN 55014-2:1997/A2:2008 CISPR 14-2:1997/A2:2008	Electromagnetic compatibility. Requirements for household appliances, electric tools and similar apparatus. Immunity. Product family standard.
	EN 61000-3-2:2014	Electromagnetic compatibility (EMC). Limits. Limits for harmonic current emissions (equipment input current $\leq 16A$ per phase).
	EN 61000-3-3:2013	Electromagnetic compatibility (EMC). Limits. Limitation of voltage changes, voltage fluctuations and flicker in public low-voltage supply systems, for equipment with rated current $\leq 16A$ per phase and not subject to conditional connection.
Specifications with which Conformity is Declared:	Electromagnetic Compatibility Directive	
We hereby certify that the machinery described above conforms with the essential health and safety requirements of Council Directive 2004/108/EC on the approximation of the laws of the Member States relating to the safety of machinery.		
Date:		
Signed:		
Signatory:	Mark Cox Director of Engineering	



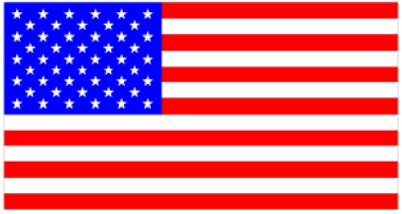

## Declaration of Noise Emission

The Dexter Laundry Commercial Drying System Models Sound Pressure Levels per EN ISO 11202 as measured on similarly constructed models are as follows:

Model DCBD30KC-64FN	Operating	Idle
$L_{pAm}$ (Operator Position)	61 dB (A)	54 dB (A)
$L_{pAm}$ (Bystander Position)	68 dB (A)	58 dB (A)
Peak C-weight instantaneous SPL in the Operator's position	73 dB (C)	---
Sound power emitted where the equivalent continuous A-weighted SPL exceeds 80 dB (A).	N/A	---
The average difference between the extraneous noise level and the sound intensity level at each measuring point is:	$L_{pAm} \Delta = 9 \text{ dB (A)}$	
Ambient Correction Factor K3A calculated according to EN ISO 11204 Appendix A.	4 dB( A)	
Measurements were made at a height of 1.5 m and 1 m from the Operator Position and all four sides of the equipment.		
<p>The figures quoted are emission levels and are not necessarily safe working levels. While there is a correlation between the emission and exposure levels this cannot be used reliably to determine whether or not further precautions are required.</p> <p>Factors that influence the actual level of exposure of the workforce include characteristics of the work room, the other sources of noise, etc. such as the number of machines and other adjacent processes. Also, the permissible level of exposure can vary from country to country.</p> <p>This information, however, will enable the user of the machine to make a better evaluation of the hazard and risk.</p>		
	Dexter Laundry, Inc. 2211 West Grimes Avenue Fairfield, IA 52556 USA	



<b>EC DECLARATION OF CONFORMITY WITH COUNCIL DIRECTIVE 2009/142/EC</b>		
Directive:	Appliances Burning Gaseous Fuels Directive 2009/142/EC	
Conforming Machinery:	Industrial Drying System Model Numbers: DN30X2N, DN50X2N, DN0030N, DN0050N, DN0080N, DN0120N, DNS030N, DNS050N	
Manufacturer:	Dexter Laundry, Inc. 2211 West Grimes Avenue Fairfield, IA 52556 USA	
Harmonised Standards Referenced or Applied:	EN 12752-1:1999	Gas-Fired type B tumble dryers of nominal heat input not exceeding 20kW - Part 1: Safety
Specifications with which Conformity is Declared:	Appliances Burning Gaseous Fuels Directive	
<p>We hereby certify that the machinery described above conforms with the essential health and safety requirements of Council Directive 2009/142/EC on the approximation of the laws of the Member States relating to the safety of machinery. The products listed have been designed and manufactured in accordance with the type as described in the EC Type Examination Certificate issued by Intertek Testing &amp; Certification Ltd (Notified Body 0359).</p>		
Date:		
Signed:		
Signatory:	Mark Cox Director of Engineering	