



DEXTER[®]
LAUNDRY

**USE THE BLUE TABS LOCATED ON THE
RIGHT AND LEFT SIDES OF THE FOLLOWING
DOCUMENT TO ADVANCE TO EACH SECTION.**











DEXTER
LAUNDRY



Dexter Industrial OPL Dryer DCBD80HC_-10BD & DN0080NC-10EB2R

Parts & Service Manual

Equipment Safety Warnings Symbols and Terminology Used in this Equipment

	Indicates an imminently hazardous situation, which if not avoided, will result in death or serious injury.
	Indicates a potentially hazardous situation, which if not avoided could result in death or serious injury.
	Indicates a potentially hazardous situation which, if not avoided, may result in minor or moderate injury. It may also be used to alert against unsafe practices. Minor burns, pinch points that result in bruises and minor chemical irritation.
	Indicates information or a company policy that relates directly or indirectly to the safety of personnel or protection of property.
	This is the user caution symbol. It indicates a condition where damage to the equipment resulting in injury to the operator could occur if operational procedures are not followed. TO REDUCE THE RISK OF DAMAGE OR INJURY, refer to accompanying documents; follow all steps or procedures as instructed.
	This is the electrical hazard symbol. It indicates that there are DANGEROUS HIGH VOLTAGES PRESENT inside the enclosure of this product. TO REDUCE THE RISK OF FIRE OR ELECTRIC SHOCK, do not attempt to open the enclosure or gain access to areas where you are not instructed to do so. REFER SERVICING TO QUALIFIED SERVICE PERSONEL ONLY
	Caution! There are sharp edges on various sheet metal parts internal to the enclosure. Use safety consciousness when placing or moving your hands while working in the interior of this equipment.
	Caution! To reduce the risk of damage to the Water Inlet Valve, do not supply inlet water with a temperature that exceeds 70° C. Caution! To reduce the risk of fire or explosion, do not operate this equipment in any hazardous classified (ATEX) environment.

Equipment Safety Warnings

Symbols and Terminology Used in this Equipment



Warning! Do not operate equipment if door glass is damaged in any way.



Warning! Keep clear of rotating parts.



Prohibited! Do not enter this equipment or space.



Prohibited! Do not step or stand on this equipment.

Prohibited! Do not operate without all guards and covers in place.









Prohibited! Do not operate without all guards and covers in place.



Prohibited! Do not wash or Dry clothing impregnated with flammable liquids (petrochemical).



Prohibited! Do not allow children to play in or around equipment.

	Indicates an imminently hazardous situation, which if not avoided, will result in death or serious injury.
	Indicates a potentially hazardous situation, which if not avoided could result in death or serious injury.
	Indicates a potentially hazardous situation which, if not avoided, may result in minor or moderate injury. It may also be used to alert against unsafe practices. Minor burns, pinch points that result in bruises and minor chemical irritation.
	Indicates information or a company policy that relates directly or indirectly to the safety of personnel or protection of property.
	This is the user caution symbol. It indicates a condition where damage to the equipment resulting in injury to the operator could occur if operational procedures are not followed. TO REDUCE THE RISK OF DAMAGE OR INJURY, refer to accompanying documents; follow all steps or procedures as instructed.
	This is the electrical hazard symbol. It indicates that there are DANGEROUS HIGH VOLTAGES PRESENT inside the enclosure of this product. TO REDUCE THE RISK OF FIRE OR ELECTRIC SHOCK, do not attempt to open the enclosure or gain access to areas where you are not instructed to do so. REFER SERVICING TO QUALIFIED SERVICE PERSONEL ONLY
	Caution! To reduce the risk of fire or explosion, do not operate this equipment in any hazardous classified (ATEX) environment.



WARNING

	<ul style="list-style-type: none"> • All washers and Dryers must be installed in accordance to all applicable electrical, plumbing and all other local codes. • These installation and operation instructions are for use by qualified personnel only. To avoid injury and electrical shock, do not perform any servicing other than that contained in the installation and operation instructions, unless qualified.
	Do not install washers or Dryers in an explosive atmosphere.
	<ul style="list-style-type: none"> • Care must be stressed with all foundation work to ensure a stable unit installation, eliminating possibilities of excessive vibration. • Foundation must be level within 13 mm to ensure proper washer operation.
	Do not operate Dryer if door glass is damaged in any way.
	Do not wash or Dry clothing impregnated with flammable liquids (petrochemical).



WARNING

 	Children should be supervised to ensure they do not operate or play in or around equipment.
	Keep all panels in place to protect against electrical shock and injury and add rigidity to washer.

This appliance is not intended for use by persons (including children) with reduced physical, sensory or mental capabilities, or lack of experience and knowledge, unless they have been given supervision or instruction concerning use of the appliance by a person responsible for their safety.

A washer should not be allowed to operate if any of the following occur:

- Excessive high water level.
- Machine is not connected to a properly earthed circuit.
- Door does not remain securely locked during the entire cycle.
- Vibration or shaking from an inadequate mounting or foundation

	Warning! Do not operate equipment if door glass is damaged in any way.
	Warning! Keep clear of rotating parts.
	Prohibited! Do not enter this equipment or space.
	Prohibited! Do not step or stand on this equipment.
	Prohibited! Do not operate without all guards and covers in place.
	Prohibited! Do not operate without all guards and covers in place.
	Prohibited! Do not wash or Dry clothing impregnated with flammable liquids (petrochemical).
	Prohibited! Do not allow children to play in or around equipment.

	Prohibited! Do not attempt to open, touch, or proceed before referring to the manual or unless qualified.
	Mandatory! Read all supporting documentation before operating or maintaining equipment.
	Mandatory! Disconnect power before servicing equipment.
	Mandatory! Lock out and tag out before servicing this equipment.
	Mandatory! Children should be supervised to ensure they do not operate equipment.

Dexter Safety Guidelines



WARNING

These washers are equipped with devices and features relating to their safe operation. To avoid injury or electrical shock, do not perform and service, unless qualified to do so.



WARNING

For your safety, the information in this manual must be followed to minimize the risk of fire or explosion or to prevent property damage, personal injury or loss of life.

IF YOU SMELL GAS:

- Do not try to light any appliance.
- Do not touch any electrical switch: do not use any telephone in your building.
- Clear the room, building or area of all occupants.
- Immediately call your gas supplier from a neighbor's telephone.
- Follow the gas supplier's instructions.
- If you cannot reach your gas supplier, call the fire department. Installation and service must be performed by a qualified installer, service agency or the gas supplier.

Dry only fabrics washed in water to avoid the risk of fire, including spontaneous combustions, do not dry:

- Items containing foam rubber, or any similarly textured rubber-like materials.
- Any items on which you have used a cleaning solvent or which contain flammable liquids or solids, such as naphtha, gasoline, or other oils or waxes.

To activate your warranty, be sure to return your red warranty form to the factory. Please have serial number and model ready when calling for assistance.

Table of Contents

Section 1: Specifications & Installation

Specifications, Mounting Dimensions

Specifications. & Dimensions 80Lb.....12 & 13

Section 2: Installation Instructions

Dryer Installation & Clearances.....16

Dryer Make up air17

Electrical Requirements.....17

Gas Requirements.....28

Exhaust Installation 18 & 19

Dryer Ignition & Testing20

Section 3: Dryer Operating & Programming Instructions

Dryer Operating Instructions.....24-28

Dryer Programming..... 29-35

Section 4:

Dryer Service, Troubleshooting and Schematics

Dryer Service Procedures.....38-47

Dryer Troubleshooting Tips..... 48-50

Dryer Schematics & Diagrams 60hz52 & 53

Section 5:

Dryer Parts Data

Dryer Cabinet Group.....56-63

Dryer Rear View.....64-69

Dryer Bearing Housing70

Dryer Tumbler Group71

Dryer Burnner Assembly.....72 & 73

Dryer Air Flow Switch Assembly74

Dryer Electrical Box & Informitives 76-81

Section 6:

50hz Gas Dryers

50hz Dryer Parts.....84-87

50hz Dryer Schematics.....88 & 89

Section 7:

Maintenance

Dryer.....92

Section 1:

Dryer

Specifications and Mounting

Machine Specifications: 80Lb

Dimensions / Capacity

Dry Weight Capacity - lb (kg)	80 lb	(36.3 kg)
Cabinet Height - in (cm)	76"	(193.0 cm)
Cabinet Width - in (cm)	38.38"	(97.5 cm)
Overall Depth - in (cm)	51.63"	(131.1 cm)
Door Opening - in (cm)	26"	(66.0 cm)
Cylinder Diameter - in (cm)	36.5"	(92.7 cm)
Cylinder Depth - in (cm)	38"	(96.5 cm)
Cylinder Volume - cu.ft. (liters)	23.0 cu.ft.	(651.3 l)
Tumbler Speed	40 RPM	

Airflow - cfm (M3/min)

60Hz	1200 cfm	(34.0 M3/min)
50Hz	1000 cfm	(28.3 M3/min)
Lint Screen Area	823 sq.in.	(5310.0 sq.cm)
Net Weight - lb (kg)	699 lbs	(291.2 kg)

Shipping Dimensions:

Shipping Weight	729 lbs	(331.2 kg)
Height - in (cm)	81.0"	(205.7 cm)
Width - in (cm)	40.25"	(102.2 cm)
Depth - in (cm)	55.5"	(141.0 cm)

BTU's /Circuit Breaker / Running Amps / Wire Size

Gas Models

60Hz	215,000 BTU/hr	(26.4 kW)
50Hz	195,000 BTU/hr	(23.4 kW)
Gas Supply Connection	0.5"	(12.7 mm)
Natural Gas Supply - (water column)	5 - 8"	(12.7 - 20.3 cm)
Manifold	3.5" Max	(8.9 cm)
LP Gas Supply - (water column)	11 - 13.5"	(27.9 - 34.3 cm)
Manifold	11"	(27.9 cm)

Gas Models

-10BD (120/60/1 - 2 wire + ground)	15 amp / 9.6amp / #12
-39BD (230/50/1 - 2 wire + ground)	10 amp / 5.1amp / #14

Electric (per pocket)

Installation Recommendations

Clearance Behind Machines	18"	(45.7 cm)
Make-up Air Req. (per dryer)	1.5 sq.ft.	(1394 sq.cm)
Exhaust Size - in (cm)	8"	(20.3 cm)

Section 2: Dryer Installation

Dryer Installation

All commercial dryer installations must conform with local applicable local codes or in the absence of local codes, with the National Fuel Gas Code ANSI Z223.1A-1988. Canadian installations must comply with current standard CAN/CGA-B149(.1 or .2) Installation Code for Gas Burning Appliances or Equipment, and local codes if applicable. The appliance, when installed, must be electrically grounded in accordance with the National Electric Code, ANSI/NFPA No. 70-1990, or when installed in Canada, with Standard CSA C22.1 Canadian Electrical Code Part 1.

Installation Clearances:

This unit may be installed at the following alcove clearances. (millimeters)

1. Left side- 0"
2. Right side- 0" *
3. Back- 18" (457) (Certified for 1" (25) clearance; however, 18" (457) clearance is necessary behind the belt guard to allow servicing and maintenance.)
4. Front- 48" (1220) (to allow use of dryer)
5. Top- Refer to figure labelled "Vertical Clearance Dimensions". Certification allows 0" clearance at the top 1" (25) back from the front. However, a 1/4" (6) clearance is required to allow opening the upper service door. A 10" (254) clearance is required from the top at all other points.
6. Floor- This unit may be installed upon a combustible floor.
*Units may be installed in direct contact with an adjacent dryer, providing allowance is made for opening upper and lower service doors.
Do not obstruct the flow of combustion and ventilation air.
Maintain minimum of 1" (25) clearance between duct and combustible material.

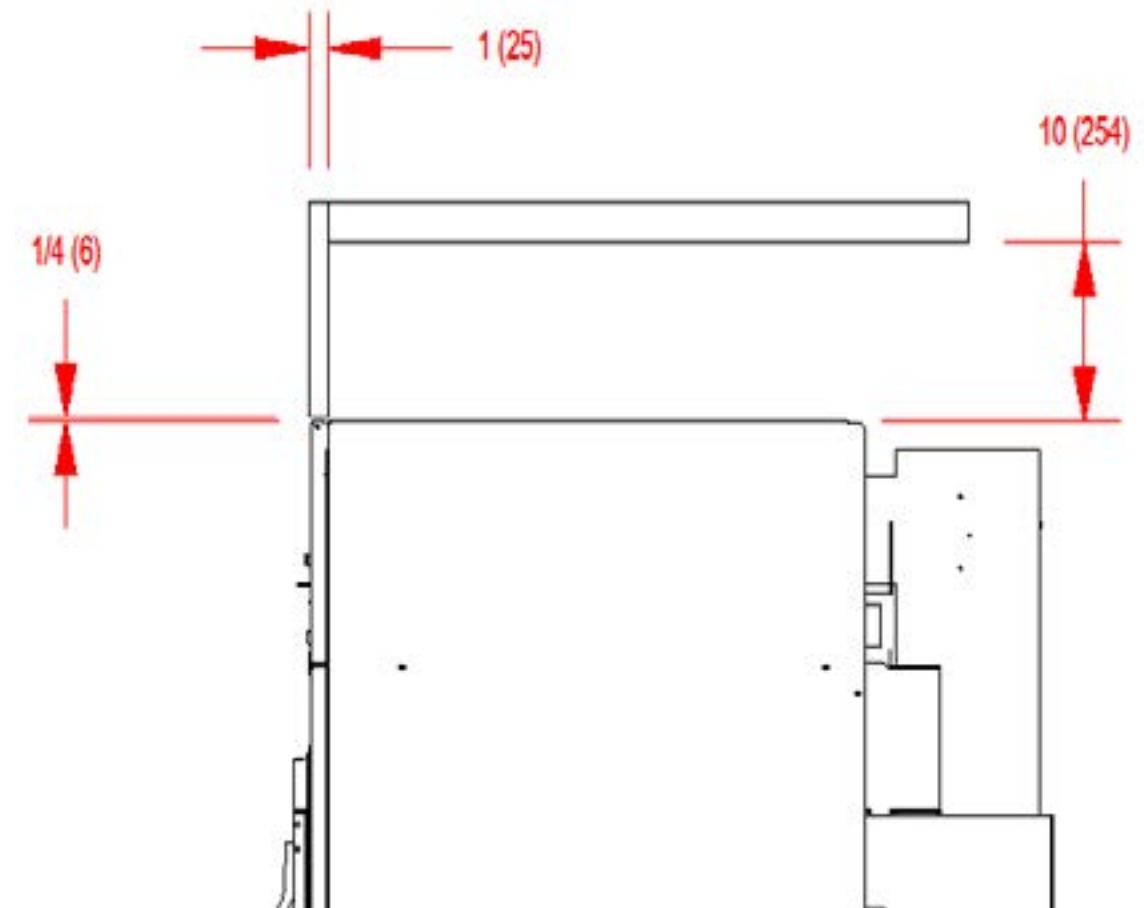

VERTICAL CLEARANCE DIMENSIONS - ALL DCBD(30/50/80)

MAKE-UP AIR

Adequate make-up air must be supplied to replace air exhausted by dryers on all types of installations. Provide a minimum make-up air opening to the outside for each dryer as follows:

Dryer Model	Make-up Air Volume/Time	Make-up Air Opening Area (minimum)
DCBD80HC-10BD	1200 CFM (34.0 m3/minute)	1.5 ft ² (0.14 m ²)
DCBD80HC-39BD	1000 CFM (28.3 m3/minute)	1.5 ft ² (0.14 m ²)

This is a net requirement of effective area. Screens, grills or louvers, which will restrict the flow of air, must be considered. Consult the supplier to determine the free area equivalent for the grill being used. The source of make-up air should be located sufficiently away from the dryers to allow an even airflow to the airintakes of all dryers. Multiple openings should be provided.

NOTE: The following considerations must be observed for gas dryer installations where dry cleaners are installed. The sources of all make-up air and room ventilation air movement to all dryers must be located away from any dry cleaners. This is necessary so that solvent vapors will not be drawn into the dryer inlet ducts. Dry cleaner solvent vapors will decompose in contact with an open flame such as the gas flame present in clothes dryers. The decomposition products are highly corrosive and will cause damage to the dryer(s), ducts and clothes loads.

ELECTRICAL REQUIREMENTS.

The electrical power requirements necessary to operate the unit satisfactorily are listed on the serial plate located on the back panel of each dryer. The electrical connection should be made to the terminal block in the rear control box assembly on the rear of the unit, using a wire size adequate to handle the amperage and voltage listed on the serial plate, but never smaller than No.12 AWG wire. It is absolutely necessary that the dryer be grounded to a known ground.

Individual circuit breakers for each unit are recommended. The wiring diagram is located on the belt guard on the back of the machine.

TRANSIENT VOLTAGE SURGE SUPPRESSORS

Like most electrical equipment your new machine can be damaged or have its life shortened by voltage surges due to lightning strikes which are not covered by factory warranty. Local power distribution problems also can be detrimental to the life of electrical components. We recommend the installation of transient voltage surge suppressors for your new equipment. These devices may be placed at the power supply panel for the complete installation and don't require an individual device for each machine.

These surge protectors help to protect equipment from large spikes and also from small ongoing spikes in the power that occur on a day to day basis. These smaller surges can shorten overall life of electrical components of all types and cause their failure at a later date. Although they can't protect against all events, these protective devices have a good reputation for significantly lengthening the useful life of electronic components.

Electronic Components are helped to have a longer useful life when they are supplied with the clean stable electrical power they like.

MANUFACTURER

Innovative Technology, Inc

CONTACT

(Eaton) Factory

PHONE

1-800-647-8877 or www.itvss.com

EFI Electronics Corporation
(Schneider Electric)

Factory
Distributor – Surge Pro

1-800-877-1174 or www.efinet.com
1-877-233-0153

MCG Surge Protection

Factory

1-800-851-1508 or www.mcgsurge.com

Advanced Protection
Technologies Inc.

Factory

1-800-237-4567 or www.aptsurge.com

GAS REQUIREMENTS.

The complete gas requirements necessary to operate the dryer satisfactorily are listed on the serial plate located on the back panel of the dryer. The inlet gas connection to the unit is 1/2 inch pipe thread. A joint compound resistant to the action of liquefied petroleum gases should be employed in making pipe connections. A 1/8 inch NPT plugged tapping, accessible for test gage connection, must be installed immediately upstream of the gas supply connection to the dryer. A drip tee should be provided in the gas piping entering the unit to catch dirt and other foreign articles. All pipe connections should be checked for leakage with soap solution. Never check with an open flame. For altitudes above 2,000 feet (610m) it is necessary to derate the BTU input. Contact your local distributor for instructions. L.P. gas conversion kits are available for this dryer. Contact your local distributor.

CAUTION: The dryer and its individual shutoff valve must be disconnected from the gas supply piping system during any pressure testing of that system at test pressures in excess of 1/2 psig. The dryer must be isolated from the gas supply piping system by closing its individual manual shutoff valve during any pressure testing of the gas supply piping system at test pressures equal to or less than 1/2 psig

Burner Set-Up

All gas burner manifolds should be checked for proper gas pressure while burning. Dryer manifold pressure should be set at 3.5 W.C. for Natural Gas while burner operating.

EXHAUST INSTALLATION. (Refer to Figure 2 at the end of section 6.) Exhausting of the dryer(s) should be planned and constructed so that no air restrictions occur. Any restriction due to pipe size or type of installation can cause slow drying time, excessive heat, and lint in the room.

From an operational standpoint, incorrect or inadequate exhausting can cause a cycling of the high limit thermostat which shuts off the main burners and results in inefficient drying.

Individual exhausting of the dryers is recommended. All heat, moisture, and lint should be exhausted outside by attaching a pipe of the proper diameter to the dryer adapter collar and extending it out through an outside wall.

This pipe must be very smooth on the inside, as rough surfaces tend to collect lint which will eventually clog the duct and prevent the dryer from exhausting properly. All elbows must be smooth on the inside. All joints must be made so the exhaust end of one pipe is inside the next one downstream. The addition of an exhaust pipe tends to reduce the amount of air the blower can exhaust. This does not affect the dryer operation if held within practical limits. For the most efficient operation, it is recommended that no more than 20' (6m) of straight 8" diameter pipe be used with two right angle elbows. When more than two elbows are used, 2' (600mm) of straight pipe should be removed for each additional elbow. No more than four right angle elbows should be used to exhaust a dryer.

Maintain minimum 1" (25) clearance between duct and combustible material.

If the exhaust pipe passes through a wall, a metal sleeve of slightly larger diameter should be set in the wall and the exhaust pipe passed through this sleeve. This practice is required by some local codes and is recommended in all cases to protect the wall. This type of installation should have a means provided to prevent rain and high winds from entering the exhaust when the dryer is not in use. A hood with a hinged damper can be used for this purpose. Another method would be to point the outlet end of the pipe downward to prevent entrance of wind and rain. In either case, the outlet should be kept clear, by at least 24" (610), of any objects which would cause an air restriction.

Never install a protective screen over the exhaust outlet. When exhausting a dryer straight up through a roof, the overall length of the duct has the same limits as exhausting through a wall. A rain cap must be placed on top of the exhaust and must be of such a type as to be free from clogging. The type using a cone shaped "roof" over the pipe is suitable for this application.

Exhausting the dryer into a chimney or under a building is not permitted. In either case there is a danger of lint build-up which can be highly combustible.

Installation of several dryers, where a main discharge duct is necessary, will need the following considerations for installation (see Fig. 2). Individual 8" (200mm) ducts from the dryers into the main discharge duct should be at a 45 degree angle in the direction of discharge air flow.

NOTE: Never install the individual 8" ducts at a right angle into the main discharge duct. The individual ducts from the dryers can enter at the sides or bottom of the main discharge duct. Figure 2 indicates the various round main duct diameter to use with the individual dryer ducts. The main duct can be rectangular or round, provided adequate air flow is maintained. For each individual dryer, the total exhausting (main discharge duct plus duct outlet from the dryer) should not exceed the equivalent of 20 feet (6m) and two elbows. The diameter of the main discharge duct at the last dryer must be maintained to exhaust end.

NOTE: A small diameter duct will restrict air flow; a large diameter duct will reduce air velocity – both contributing to lint build up. An inspection door should be provided for periodic clean-out of the main duct.

NOTE: STATIC BACK PRESSURE should be a maximum of 0.3 in. w.c (7.6 mm w.c) at the rear exhaust outlet of the dryer. If multiple dryers are connected to the common duct, ensure the back draft damper is installed properly.

NOTE: The following illustration shows the various round main duct diameters to use with the individual dryer ducts. The main duct can be rectangular or round, provided adequate air flow is maintained. For each individual cylinder the total exhausting (main discharge duct plus duct outlet from the dryer) should not exceed the equivalent of 14 feet and two elbows. The diameter of the main discharge duct at the last dryer must be maintained to exhaust end.

DRYER IGNITION (SOLID STATE IGNITION).

The solid state ignition system lights the main burner gas by spark. The gas is ignited and burns only when the gas-valve relay (in the electronic controller) calls for heat. The procedure for first-time starting of a dryer is as follows:

A. First, review and comply with the "WARNINGS ABOUT USE AND OPERATION" found on the inside front cover of this manual. Be sure the electrical power supply is connected correctly. The white (neutral) wire is to be connected to the N terminal while the black (line) wire to the L1 terminal of the terminal block in the rear control box. The dryer MUST be properly grounded.

B. Make sure all gas supply lines are purged of air. Close the main gas shut-off valve and wait for five minutes before turning the valve back on.

C. Turn on main electrical power switch. The dryer may be started by following the "OPERATING INSTRUCTIONS" found later in this manual.

D. Natural gas and liquefied petroleum gas fired dryers both operate in the same manner. When gas-valve relay contacts are closed (indicating a demand for heat), the solid state ignition control will automatically supply energy to the redundant gas valve. Spark will continue until a flame is detected by the sensing probe, but not longer than 10 seconds. If the gas fails to ignite within 10 seconds, the gas will shut off for 15 seconds. The control will attempt to ignite two more times in a similar manner. If the gas fails to ignite after three tries, the gas valve closes and the system will "lock out". No further attempts at ignition will be performed automatically. It is then necessary to interrupt electrical power to the ignition system before making another attempt to light the burners.

This can be done by opening the dryer door, allowing the dryer to come to a stop for 15 seconds, closing the door, and pushing the "Start" button. The dryer will then repeat the ignition trial cycle.

DRYER SHUTDOWN

To render the dryer inoperative, turn off the main gas shut-off valve and disconnect electrical power to the dryer.

IT IS RECOMMENDED THAT THE INSTALLER TEST THE DRYER FOR OPERATION AND INSTRUCT THE USER BEFORE LEAVING THE INSTALLATION.



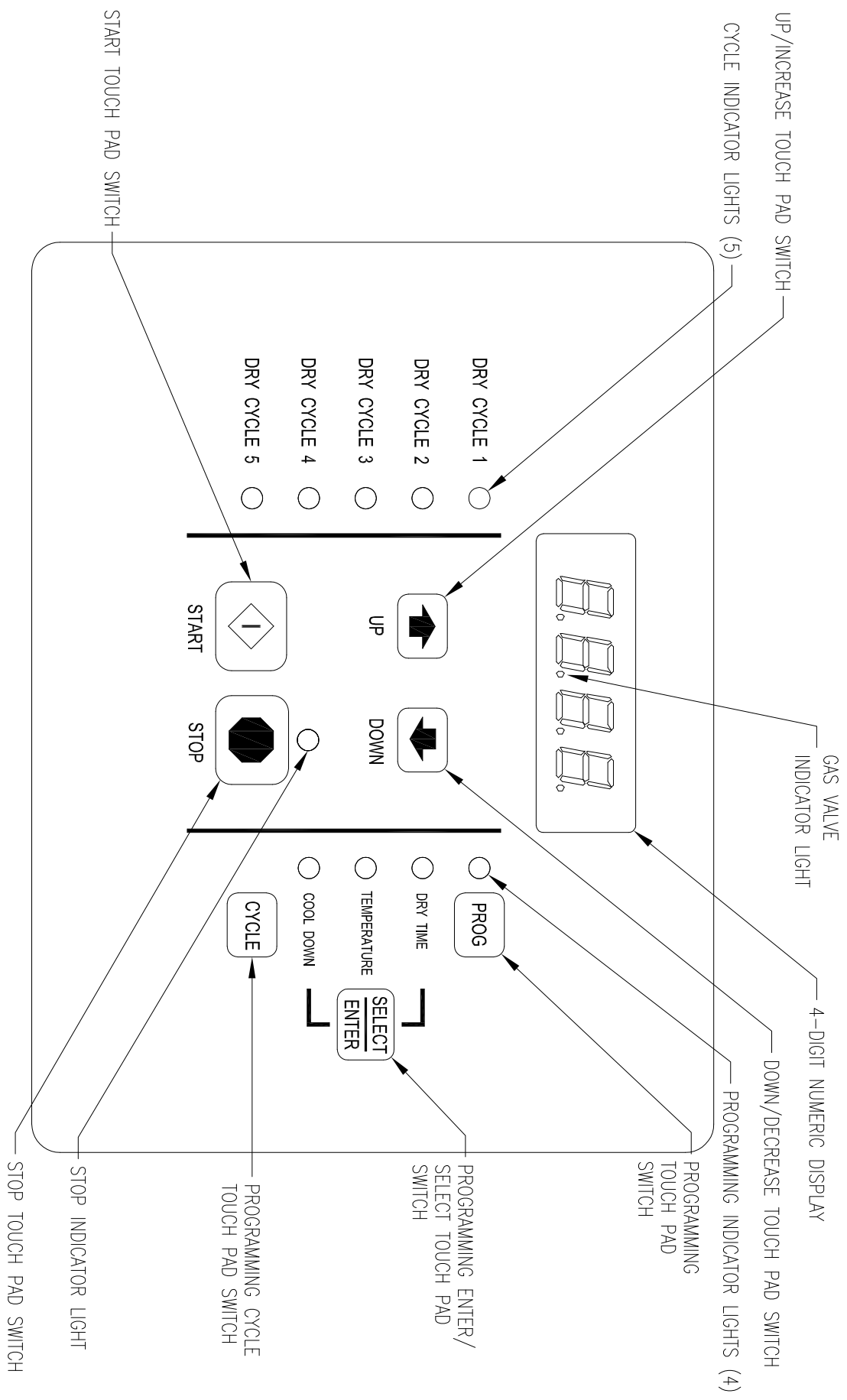

Section 3:

Dryer Operating & Programing Instructions

TOUCH PAD DESCRIPTION

INDICATOR LIGHTS (L.E.D.s)

Description

Cycle (1 through 5)

These L.E.D.s are on solid when a particular cycle is chosen for operation or programming.

Gas Valve

This L.E.D. is part of the 4-digit numeric display and will be on solid during the drying part of a cycle when the gas valve does not need to be on. The L.E.D. will be blinking when the gas valve needs to be on. The L.E.D. will not be on solid or blinking (off) if the cycle is stopped, complete, in cool down, or terminated.

Programming

These L.E.D.s are on solid as they are selected during the programming of the dryer controller.

Stop

This L.E.D. is on solid when either the STOP button is pressed once or the door is opened during an operating cycle.

SWITCHES (Pushbuttons)

Description



UP

This touch pad switch will increment (increase) dry time, cool down time, and drying temperature. It will also scroll upwards when selecting a dry cycle.

UP/INCREASE



Down

This touch pad switch will decrement (decrease) dry time, cool down time, and drying temperature. It will also scroll downwards when selecting a dry cycle.

DOWN/DECREASE



This touch pad switch allows the dryer controller to enter the permanent programming mode.

PROGRAM



This touch pad switch will select one of the three variable parts of the dry cycle (dry time, temperature, or cool down) by sequencing through them. Once one of the variable parts of the dry cycle is chosen and changed, this touch pad switch will enter the new (changed) value into the dry cycle program.

SELECT/ENTER

This touch pad switch allows the dryer controller to enter the temporary programming mode.



This touch pad switch allows the dryer controller to enter the Cycles 1 thru 5.

CYCLE



STOP

This touch pad switch will stop the dryer during a dry cycle without clearing the present drying cycle if pressed once. If pressed and released twice, consecutively, the present dry cycle will be cleared.

STOP



START

This touch pad switch will start the operation of a dry cycle if pressed and released once. Pressing and holding this touch pad switch will display the current temperature of the dryer heat sensor as long as it is held in the depressed position.

START

4-DIGIT NUMERICAL DISPLAY MESSAGES

Description

LOAD	This message is displayed after a dry cycle is complete and the dryer loading door has been opened or the STOP touch pad switch on the dryer controller has been pressed and released twice.
donE	This message blinks immediately after completion of the dry cycle and continues to blink until the STOP touch pad switch on the dryer controller is pressed or the dryer loading door is opened.
Prog	This message is displayed when entering the permanent programming mode.
.15	This message appears while the dryer is in the heating time of a dry cycle. The decimal point will blink if the output for the gas valve is on, or remain on constantly if the output for the gas valve is not on. The number represents the total time left in the dry cycle (includes cool down time).
C02	This message appears when the cool down time of the dry cycle is reached. The letter "C" represents the cool down (non-heating) part of the dry cycle. The number(s) after the letter "C" represent(s) the total time remaining in the dry cycle.
F5	This message appears if there is a dryer fault. The letter "F" indicates a fault and the number after the "F" represents the specific fault that has occurred. There are five different faults that can appear (F1 through F5).
rEv	This message is displayed while in the programming mode, to indicate the reversing function during the dry cycle.
nrEv	This message is displayed, while the programming mode, to indicate the nonreversing function during the dry cycle.

OPERATING INSTRUCTIONS

To dry a load of items, you must choose one of the five-programmed dry cycles. Each of these five dry cycles may be modified in two different ways to match your load. Please, refer to the "Permanent Reversing Dryer Controller Programming" or "Temporary Reversing Dryer Controller Programming" section of this manual.

There are two parts to each dry cycle. The first part is the heating time, which is when the gas valve is cycled on and off according to the temperature setting in the dry cycle program. The second part is the cool down time, which is after the heating part of the dry cycle, and when the cylinder continues to turn, but no heat is applied.

There will always be at least two minutes of cool down time for each dry cycle. The maximum amount of cool down time is 60 minutes. During a reversing dry cycle, the tumbler will rotate in one direction for one minute, decelerate for four seconds, and then rotate in the opposite direction for one minute. This motion will repeat for the duration of the dry cycle. If the controller has a red dot sticker, the amount of reversing time can be set to either one or two minutes. To change the reversing time, the 4-digit numerical display must show "LOAD". Then, press and hold the SELECT/ENTER touch pad switch and then press the UP touch pad switch to set the time to two minutes or the DOWN touch pad switch to set the time to one minute. The buzzer will then beep to indicate the change was successful. The change will be retained even if the power is removed. The factory default is one minute.

The five default dry cycle values are shown in the "REVERSING DRYER CONTROLLER FACTORY DEFAULT PROGRAM SETTINGS" table in this manual.

To improve the drying capabilities of this dryer, you should always separate (untangle) the individual articles in your load before using the dryer.

In the following instruction steps, things that are displayed on the 4-digit numerical display will be in "quotation marks" and any touch pad switches on the dryer controller that physically need to be pressed will be in **CAPITAL AND BOLD LETTERS**.

- 1) Place your untangled load into the dryer cylinder and close the dryer loading door. Notice that the dryer controller 4-digit numerical display should show the word "LOAD". If it does not show this word, then press and release the **STOP** touch pad switch on the dryer controller twice.
- 2) Press and release the **UP** or **DOWN** touch pad switch on the dryer controller to select a dry cycle.
- 3) Once the desired dry cycle is selected, press and release the **START** touch pad switch.

After the dryer controller **START** touch pad switch is pressed, the dryer cylinder will start rotating and the two-digit total dry cycle time, along with a decimal point, will appear on the dryer controller display.

The time shown on the dryer controller display will count down to the programmed cool down time. At that time, the display will change from the decimal point and two-digit number to a letter "C" and two digits.

The letter "C" represents the cool down portion of the dry cycle. The two digits represent the amount of time remaining in the dry cycle. The two-digit time, shown on the dryer controller display, will count down to zero.

When the time decrements to zero, the dryer controller display will flash the work "donE" and the end of cycle tone will sound.

At that point, the wrinkle free cycle will automatically begin. This cycle will wait two minutes, if the door is not opened or the **STOP** touch pad switch on the dryer controller is not pressed, and then rotate the cylinder for 10 seconds and stop. This two-minute of idle time and 10 seconds of tumble time will repeat a total of 10 times, at which time the wrinkle free cycle stops. The cylinder will not rotate again until a new dry cycle is started.

During the dry cycle, either pressing the **STOP** touch pad switch on the dryer controller or opening the dryer loading door will stop the dry cycle and not clear it. If you press the **STOP** touch pad switch on the controller and then open the dryer loading door, the dry cycle will not be cleared. However, if you open (or open and close) the dryer loading door and then press the **STOP** touch pad switch on the dryer controller, the present dry cycle will be cleared and the word "LOAD" will appear on the dryer controller display.

Jumper Options

There are two jumpers and one push button on the component side of the dryer controller printed circuit board.

The jumper located at the lower right side of the circuit board controls whether the controller display shows and operates in the Fahrenheit or Celsius mode. This jumper is labeled as TEMP SELECT and has three pins.

The bottom and middle pins are for Celsius and the top and middle pins are for Fahrenheit, which is indicated by the letter C for Celsius and the letter F for Fahrenheit.

The other jumper, located at the upper right side of the component side of the dryer controller circuit board, is used for choosing either a reversing or non-reversing type of dryer. This jumper is labeled as REV and NON-REV. This jumper must be in the reversing position, which are the bottom and middle pins. If the jumper is in the non-reversing position, the heating part of the dry cycle will not operate properly. The dryer will not reverse direction.

Factory Reset

The push button, which is located at the lower middle side of the component side of the dryer controller circuit board, is used to reset all five of the dry cycles to the factory default settings. It is labeled as DEFAULT SETTINGS. Even the dry cycles that have been modified using the permanent programming procedure will be changed back to the factory default settings when using this push button. This push button must be pressed and held for at least three seconds with power applied to the dryer controller circuit board.

DRY CYCLE	DRYER DIRECTION	COOL DOWN TIME (minutes)	TOTAL CYCLE TIME (minutes)	DRYING TEMPERATURE		DRYER LOAD
				F	C	
1	REV.	5	35	180	82	Towels, pads, heavy cotton
2	REV.	2	20	170	77	Sheets, blended materials
3	REV.	5	25	180	82	Cotton
4	NON-REV.	2	20	130	54	Synthetic Materials
5	NON-REV.	2	25	175	79	Blended Materials

TEMPORARY REVERSING DRYER CONTROLLER PROGRAMMING

Temporary programming mode will allow the change of the stored dry cycle settings in the dryer controller for one complete dry cycle. After the dry cycle is complete, the default settings that existed before the temporary change are restored. The temporary dry cycle can be stopped and cleared at any time during the dry cycle operation.

To temporarily change a dryer controller cycle, follow the procedures below. Things that are displayed on the 4-digit numeric display will be in "quotation marks". Touch pad switches on the dryer controller that physically need to be pressed will be in **CAPITAL AND BOLD LETTERS**.

If, at any time, you want to escape the temporary programming mode while changing the program settings, you can press the **STOP** touch pad switch on the dryer controller if the 4-digit numeric display is not flashing. The **SELECT/ENTER** touch pad switch on the dryer controller can be pressed and released to enter the flashing value shown on the 4-digit numeric display and allow you to escape.

If you press and release the **STOP** touch pad switch on the dryer controller, when the 4-digit numeric display is not flashing, the temporary changes to the dry cycle program will be cancelled. The stored dry cycle settings that existed before the temporary change will then be restored.

If, at any time, you want to start the temporary dry cycle during the temporary programming mode, press and release the **START** touch pad switch on the dryer controller if the 4-digit numeric display is not flashing. The **SELECT/ENTER** touch pad switch on the dryer controller can be pressed and released to enter the flashing value shown on the 4-digit numeric display and allow you to start the temporary dry cycle. If you start the temporary dry cycle, the 4-digit numerical display will change the total dry time and count down to 0 as the dry cycle progresses.

PROCEDURE

- 1) Make sure the dryer is not in a dry cycle. The 4-digit numeric display on the dryer controller will show "LOAD" when the dryer is not in a dry cycle.
- 2) Press and release the **UP** or **DOWN** touch pad switch on the dryer controller to choose the dry cycle that you want to change (dry cycle 1 through 5). The dry cycle L.E.D. will illuminate to indicate which dry cycle you are choosing. If you press and hold down either the **UP** or **DOWN** touch pad switch, the controller will sequence through the five dry cycles.
- 3) Press and release the **CYCLE** touch pad switch on the dryer controller once you have chosen the dry cycle you want to change. After you press the **CYCLE** touch pad switch, the programming L.E.D. and the dry time L.E.D. will illuminate, the dry cycle L.E.D. will remain illuminated, and the total dry time will be displayed on the 4-digit numeric display.
- 4) Press and release the **UP** or **DOWN** touch pad switch on the dryer controller to change the total cycle time. Once either the **UP** or **DOWN** touch pad switch is pressed, the dry time L.E.D. and the total dry time on the 4-digit numeric display will flash. If you press and hold down either the **UP** or **DOWN** touch pad switch, you will increment (**UP** arrow) or decrement (**DOWN** arrow) through the total dry times available (1 through 60 minutes). This display dry time includes the cool down time along with the heated time. To not change the cool down time, do not press either the **UP** or **DOWN** touch pad switch. Go to the next step.

- 5) Press and release the **SELECT/ENTER** touch pad switch on the dryer controller. Once the **SELECT/ENTER** touch pad switch is pressed and released, the dry time L.E.D. will switch off, the dry cycle L.E.D. and programming L.E.D. will remain on, the temperature L.E.D. will illuminate, and the drying temperature will be shown on the 4-digit numeric display.
- 6) Press and release either the **UP** or **DOWN** touch pad switch on the dryer controller to change the drying temperature. Each press and release of either the **UP** or **DOWN** touch pad switch will either increase or decrease, respectively, the temperature by five degrees Fahrenheit or three degrees Celsius, depending on how your dryer controller is set up. Once either the **UP** or **DOWN** touch pad switch is pressed, the temperature L.E.D. and the drying temperature on the 4-digit numeric display will flash. If you press and hold down either the **UP** or **DOWN** touch pad switch, you will increment (**UP** arrow) or decrement (**DOWN** arrow) your way through the available drying temperatures (105° Fahrenheit or 41° Celsius, up to 195° Fahrenheit or 90° Celsius). If you do not want to change the drying temperature, do not press either the **UP** or **DOWN** touch pad switch. Go to the next step.
- 7) Press and release the **SELECT/ENTER** touch pad switch on the dryer controller. Once the **SELECT/ENTER** touch pad switch is pressed and released, the temperature L.E.D. will switch off, the dry cycle L.E.D. and programming L.E.D. will remain on, the cool down L.E.D. will illuminate, and the cool down time will be shown on the 4-digit numeric display.
- 8) Press and release either the **UP** or **DOWN** touch pad switch on the dryer controller to change the cool down time. Once either the **UP** or **DOWN** touch pad switch is pressed, the temperature L.E.D. and the cool down time on the 4-digit numeric display will flash. If you press and hold down either the **UP** or **DOWN** touch pad switch, you will increment (**UP** arrow) or decrement (**DOWN** arrow) through the cool down times available (2 through 60 minutes if the controller has a red dot sticker or 2 through 15 minutes if the controller has no red dot sticker). To not change the cool down time, do not press either the **UP** or **DOWN** touch pad switch. Go to the next step.
- 9) Press and release the **SELECT/ENTER** touch pad switch on the dryer controller. Once the **SELECT/ENTER** touch pad switch is pressed and released, the cool down L.E.D. will switch off, the dry cycle L.E.D. and the programming L.E.D. will remain on, the reversing L.E.D. will illuminate, and either "rEv" (reversing mode) or "nrEv" (non-reversing mode) will be shown on the 4-digit numeric display.
- 10) Press and release either the **UP** or **DOWN** touch pad switch to change between reversing and nonreversing operation. Once either the **UP** or **DOWN** touch pad switch is pressed, the reversing L.E.D. and the "rEv" (reversing mode) or the "nrEv" (non-reversing mode) shown on the 4-digit numeric display will flash. To not change the reversing or non-reversing mode of operation, do not press either the **UP** or **DOWN** touch pad switch. Go to the next step.
- 11) Press and release the **SELECT/ENTER** touch pad switch on the dryer controller. Once the **SELECT/ENTER** touch pad switch is pressed and released, the programming L.E.D. will switch off, the reversing L.E.D. and the dry cycle L.E.D. will remain on, and the flashing reversing (rEv) or the non-reversing (nrEv) on the 4-digit numeric display will stop flashing and remain.
- 10) At this point, you have two choices:
 - a) You can perform the modified dry cycle by pressing and releasing the **START** touch pad switch on the dryer controller touch pad. If you start the modified cycle, the total dry time will appear on the 4-digit numeric display and it will count down to 0 as the dry cycle progresses.
 - b) You can clear the modified dry cycle program by pressing and releasing the **STOP** touch pad switch. If you choose to clear the modified dry cycle, the 4-digit numeric display will change to "LOAD".

TEMPORARY REVERSING DRYER CONTROLLER PROGRAMMING EXAMPLE

REQUIREMENTS: Dry a load with 40 minutes of actual heat at 185°F and five minutes of cool down.

The following procedure will show you how to temporarily modify the existing dry cycle 5 program for one cycle of drying. It is based on the assumption that the factory defaults have not been permanently changed. If they have been changed, the steps of this procedure will be the same, but the values that are displayed will be different. The amount of times that the **UP** or **DOWN** touch pad switches of the dryer controller must be pressed and released may also be different.

If you want the change to be permanent, go to the "PERMANENT DRYER CONTROLLER PROGRAMMING" section of this manual.

PROCEDURE:

- 1) After the load has been placed in the dryer, press and release the **UP** or **DOWN** touch pad switch on the dryer controller until the L.E.D. for dry cycle 5 is illuminated.
- 2) Press and release the **CYCLE** touch pad switch on the dryer controller. You will see the number "25" on the dryer controller display. The programming L.E.D. and dry time L.E.D. will be illuminated.
- 3) Press and release the **UP** touch pad switch on the dryer controller 17 times so that the display will show a flashing "42". When the **UP** touch pad switch is pressed the first time, the number "26" will be flashing on the dryer controller display. Each number after that will also flash.
- 4) Now, press and release the **SELECT/ENTER** touch pad switch on the dryer controller. The number "42" will stop flashing, the dry time L.E.D. will switch off, the dryer controller display will now show "175", the temperature L.E.D. will illuminate, and the programming L.E.D. and dry cycle 5 L.E.D. will remain on.
- 5) Press and release the **UP** touch pad switch on the dryer controller one time so the controller display will show a flashing "185". Each press of the **UP** touch pad switch will increment the temperature by five degrees.
- 6) Now, press and release the **SELECT/ENTER** touch pad switch on the dryer controller. The number "185" will stop flashing, the temperature L.E.D. will switch off, the dryer controller display will now show a number "2", the cool down L.E.D. will illuminate, and the programming L.E.D. and dry cycle 5 L.E.D. will remain on.
- 7) Press and release the **SELECT/ENTER** touch pad switch on the dryer controller, since the desired cool down time is two minutes. After you press the **SELECT/ENTER** touch pad switch, the cool down L.E.D. will switch off, the dryer controller display will show "nrEv", the reversing L.E.D. will illuminate, and the programming L.E.D. and the cycle 5 L.E.D. will remain on.
- 8) Press and release either the **UP** or **DOWN** touch pad switch on the dryer controller once. A flashing "rEv" will appear on the dryer controller display and the reversing L.E.D. will start to flash. Each press and release of either the **UP** or **DOWN** touch pad switch will toggle between the reversing mode ("rEv") and the non-reversing mode ("nrEv").
- 9) Press and release the **SELECT/ENTER** touch pad switch on the dryer controller. Once the **SELECT/ENTER** touch pad switch is pressed and released, the programming L.E.D. and the reversing L.E.D. will switch off, the dry cycle 5 L.E.D. will remain on, and the flashing "rEv" will stop flashing and remain on.
You are now ready to start the new dry cycle. The new dry cycle will be in effect for one dry cycle only. After the dry cycle is done, or if the **STOP** touch pad switch on the dryer controller is pressed and released twice, consecutively, the cycle 5 program will revert to the factory default settings.
If you press the **START** touch pad switch on the dryer controller, the controller display will change from the "ReV" to the number "42" and dry cycle 5 will begin.

PERMANENT REVERSING DRYER CONTROLLER PROGRAMMING

The permanent programming mode will allow the change of the stored dry cycle settings in the dryer controller until the operator physically changes them again. The factory default settings can be restored in the dryer controller by pressing the default settings push-button on the back (component) side of the dryer controller circuit board. It is labeled and located at the lower middle side of the printed circuit board, as you face the component side of the board. It must be pressed and held down for at least three seconds.

To permanently change a dryer controller cycle, follow the procedure below. Things that are displayed on the 4-digit numeric display will be in "quotation marks". Touch pad switches on the dryer controller that physically need to be pressed will be in **CAPITAL AND BOLD LETTERS**.

If, at any time, you want to escape the permanent programming mode while changing the settings, you can press the **STOP** touch pad switch on the dryer controller if the 4-digit numeric display is not flashing. The **SELECT/ENTER** touch pad switch on the dryer controller can be pressed and released to enter the flashing value shown on the 4-digit numeric display and allow you to escape.

PROCEDURE

- 1) Make sure the dryer is not in a dry cycle. The 4-digit numeric display on the dryer controller will show "LOAD" when the dryer is not in a dry cycle.
- 2) Press and release the **PROG** touch pad switch on the dryer controller.
- 3) Press and release the **UP** touch pad switch on the dryer controller. The programming L.E.D. will illuminate and the 4-digit numeric display on the dryer controller will change to "Prog".
- 4) Press and release either the **UP** or **DOWN** touch pad switch to choose the dry cycle you want to change (dry cycle 1 through 5). The dry cycle L.E.D. will illuminate to indicate which dry cycle you are choosing. If you press and hold down either the **UP** or **DOWN** touch pad switch, the controller will sequence through the five dry cycles.
- 5) Press and release the **SELECT/ENTER** touch pad switch once you have chosen the dry cycle you want to change. After you press the **SELECT/ENTER** touch pad switch, the dry time L.E.D. will illuminate, the dry cycle L.E.D. and the programming L.E.D. will remain illuminated, and the total dry time will also be displayed on the 4-digit numeric display.
- 6) Press and release either the **UP** or **DOWN** touch pad switch on the dryer controller to change the total dry time. Once either **UP** or **DOWN** touch pad switch is pressed, the dry time L.E.D. and the total dry time on the 4-digit numeric display will flash. If you press and hold down either the **UP** or **DOWN** touch pad switch, you will increment (**UP** arrow) or decrement (**DOWN** arrow) through the total dry times available (1 through 60 minutes). The dry time on the controller display includes the cool down time along with the heated time. To not change the total dry time, do not press either the **UP** or **DOWN** touch pad switch. Go to the next step.
- 7) Press and release the **SELECT/ENTER** touch pad switch of the dryer controller. Once the **SELECT/ENTER** touch pad switch is pressed and released, the dry time L.E.D. will switch off, the dry cycle L.E.D. and programming L.E.D. will remain on, the temperature L.E.D. will illuminate, and the drying temperature will be shown on the 4-digit numeric display.

- 8) Press and release either the **UP** or **DOWN** touch pad switch of the dryer controller to change the drying temperature. Each press and release of either the **UP** or **DOWN** touch pad switch will either increase or decrease, respectively, the temperature by five degrees Fahrenheit or three degrees Celsius, depending on how your dryer controller is set up. Once either the **UP** or **DOWN** touch pad switch is pressed, the temperature L.E.D. and the drying temperature on the 4-digit numeric display will flash. If you press and hold down either the UP or DOWN touch pad switch, you will increment (**UP** arrow) or decrement (**DOWN** arrow) your way through the available drying temperatures (105° Fahrenheit or 41° Celsius, up to 195° Fahrenheit or 90° Celsius). If you do not want to change the drying temperature, do not press either the **UP** or **DOWN** touch pad switch. Go to the next step.
- 9) Press and release the **SELECT/ENTER** touch pad switch on the dryer controller. Once the **SELECT/ENTER** touch pad switch is pressed and released, the temperature L.E.D. will switch off, the dry cycle L.E.D. and programming L.E.D. will remain on, the cool down L.E.D. will illuminate, and the cool down time will be shown on the 4-digit numeric display.
- 10) Press and release either the **UP** or **DOWN** touch pad switch on the dryer controller to change the cool down time. Once either the **UP** or **DOWN** touch pad switch is pressed, the cool down L.E.D. and the cool down time on the 4-digit numeric display will flash. If you press and hold down either the **UP** or **DOWN** touch pad switch, you will increment (**UP** arrow) or decrement (**DOWN** arrow) through the cool down times available (2 through 60 minutes if the controller has a red dot sticker or 2 through 15 minutes if the controller has no red dot sticker). To not change the cool down time, do not press either the **UP** or **DOWN** touch pad switch. Go to the next step.
- 11) Press and release the **SELECT/ENTER** touch pad switch on the dryer controller. Once the **SELECT/ENTER** touch pad switch is pressed and released, the cool down L.E.D. will switch off, the dry cycle L.E.D. and programming L.E.D. will remain on, the reversing L.E.D. will illuminate, and either "rEv" (reversing mode) or "nrEv" (non-reversing mode) will be shown on the 4-digit numeric display.
- 12) Press and release either the **UP** or **DOWN** touch pad switch on the dryer controller to change between reversing and non-reversing operation. Once either of the **UP** or **DOWN** touch pad switch is pressed, the reversing L.E.D. and the "rEv" (reversing mode) or the "nrEv" (non-reversing mode) shown on the 4-digit numeric display will flash. To not change the reversing or non-reversing mode of operation, do not press either the **UP** or **DOWN** touch pad switch. Go to the next step.
- 13) Press and release the **SELECT/ENTER** touch pad switch on the dryer controller. Once the **SELECT/ENTER** touch pad switch is pressed and released, the cool down L.E.D. will switch off, the dry cycle L.E.D. and programming L.E.D. will remain on, and the 4-digit numeric display will change to "Prog".
- 12) Press and release the STOP touch pad switch on the dryer controller to save the cycle program and escape the programming mode. If you want to change the same dry cycle program again, press the **SELECT/ENTER** touch pad switch and continue at step 6 of this procedure. If you want to modify another dry cycle program, go to step 4 of this procedure and continue.
- 13) If you pressed the **STOP** touch pad switch to escape the programming mode, you may now start the dry cycle by pressing the **START** touch pad switch.

PERMANENT REVERSING DRYER CONTROLLER PROGRAMMING EXAMPLE

REQUIREMENTS: Dry a load with 50 minutes of actual heat at 195°F and three minutes of cool down.

The following procedure will show you how to permanently modify the existing dry cycle 5 program for one cycle of drying. It is based on the assumption that the factory defaults have not been permanently change. If they have been changed, the steps of this procedure will be the same, but the values that are displayed will be different. The amount of times that either the **UP** or **DOWN** touch pad switch of the dryer controller must be pressed and released may also be different.

If you want the change to be temporary (for only one dry cycle), go to the "TEMPORARY REVERSING DRYER CONTROLLER PROGRAMMING" section of this manual.

PROCEDURE:

- 1) After the load has been placed in the dryer, press and release either the **UP** or **DOWN** touch pad switch on the dryer controller until the L.E.D. for dry cycle 5 is illuminated.
- 2) Press and release the **PROG** touch pad switch on the dryer controller. The display of the dryer controller will not change.
- 3) Immediately, press and release the **UP** touch pad switch on the dryer controller. The controller display will change from "LOAd" to "Prog". You have now entered the permanent programming mode. The dry time L.E.D. will remain on and the programming L.E.D. will illuminate.
- 4) Press and release the **SELECT/ENTER** touch pad switch once. The dry time 5 L.E.D. and programming L.E.D. will remain on, the dry time L.E.D. will illuminate, and the dryer controller will show the number "25".
- 5) Press the **UP** touch pad switch 28 times until the display of the dryer controller shows the number "53".
- 6) Press and release the **SELECT/ENTER** touch pad switch of the dryer controller once. The dry cycle 5 L.E.D. and programming L.E.D. will remain on, the dry time L.E.D. will switch off, the temperature L.E.D. will illuminate, and the dryer controller display will show the number "175".
- 7) Press and release the **UP** touch pad switch four times until the dryer controller display shows the number "195".
- 8) Press and release the **SELECT/ENTER** touch pad switch of the dryer controller. The dry cycle 5 L.E.D. and the programming L.E.D. will remain on, the temperature L.E.D. will switch off, the cool down L.E.D. will illuminate, and the dryer controller display will show the number "5".
- 9) Press and release the **UP** touch pad switch once until the dryer controller display shows the number "3".
- 10) Press and release the **SELECT/ENTER** touch pad switch of the dryer controller. The dry cycle 5 L.E.D. and the programming L.E.D. will remain on, the cool down L.E.D. will switch off, the reversing L.E.D. will illuminate, and the dryer controller display will show "nrEv".
- 11) Press and release either the UP or DOWN touch pad switch on the dryer controller once. A flashing "rEv" will appear on the dryer controller display and the reversing L.E.D. will start to flash. Each press and release of either the UP or DOWN touch pad switch will toggle between the reversing mode ("rEv") and the non-reversing mode ("nrEv").

Section 4: Dryer Service, Trouble Shooting and Schematics

Service Procedures

Pressure Testing

The dryer and its individual shutoff valve must be disconnected from the gas supply piping system during any pressure testing of that system at test pressures in excess of 1/2 psig (14" water column). The dryer must be isolated from the gas supply piping system by closing its individual manual shutoff valve during any pressure testing of the gas supply piping system at test pressures equal to or less than 1/2 psig.

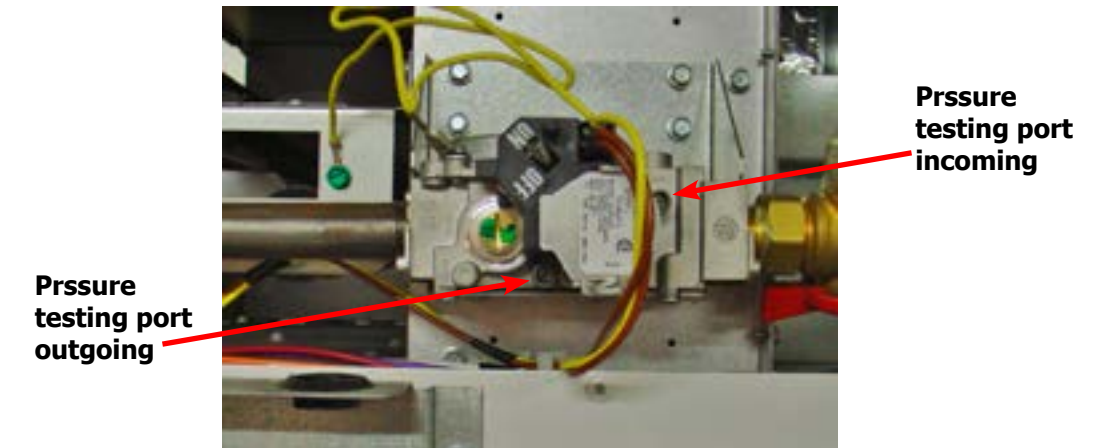

Clothes Door Removal

Step 1: Open door and remove inner hinge plate cover by removing the two Phillips screws.
Step 2: The clothes door may be removed from the hinge bracket by unscrewing and removing the top 3/16 allen head pivot screw located at the door upper hinge point, you will also need to use a 1/4 allen wrench in the lower fastener.
Step 3: Next lean the door out of the top of the hinge bracket and lift the door from the bottom hinge pin.

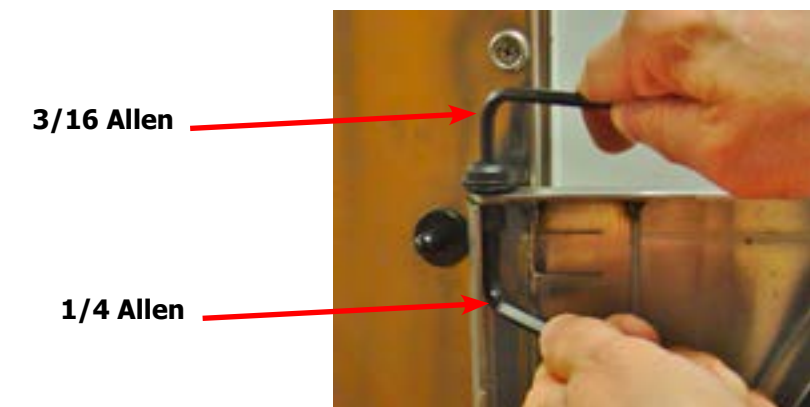

Front Panel Removal

Step 1: Remove the loading door from the panel (optional, the front panel may be removed without taking off the door).
Step 2: Open upper service door, and remove lint door.
Step 3: Then remove the two left side phillips screws w/beveled washers and the two right side phillips w/beveled washers screws. Next disconnect door switch wires from back of loading door switch.

Door Switch Removal & Installation

Step 1: Remove front panel (see front panel removal).

Step 2: Next disconnect door switch wires from back of loading door switch. Remove door switch by depressing the two tabs on switch and remove from the front of the panel.

Note: For the 80lb, you will have to remove the door switch cover first by removing the two 3/8" nuts.

Step 3: reassemble in reverse order.

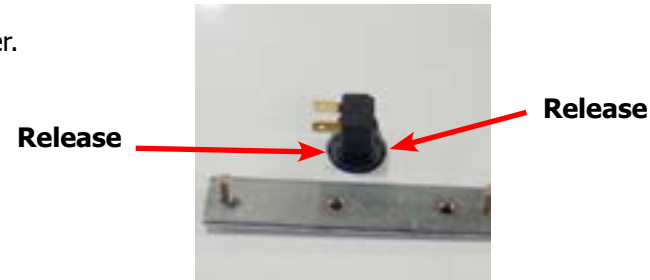

Door Switch Operation & Testing

The normally open door switch must be closed (0 ohms resistance) for the motor and heat circuits to operate. When the door is opened, the door switch opens the 24 volt control circuit.

Clothes Door Reversal (OPL only) 80Lb

Step 1: Remove the loading door from the panel. Open door and remove inner hinge plate cover by removing the two Phillips screws. The clothes door may be removed from the hinge bracket by unscrewing and removing the top 3/16 allen head pivot screw located at the door upper hinge point, you will also need to use a 1/4 allen wrench in the lower fastener. Next lean the door out of the top of the hinge bracket and lift the door from the bottom hinge pin.

Step 2: Open upper service door, and remove the lower lint door.

Step 3: Then remove the two left side phillips screws w/beveled washers and the two right side phillips w/beveled washers screws. Next disconnect door switch wires from back of loading door switch.

Step 4: Remove door switch cover, remove the 2 3/8" nuts holding cover, next remove switch by depressing the two tabs on switch and remove out front.

Step 5: Remove switch plug from left side and switch to right.

Step 6: Install switch in left side switch hole by inserting from front until switch clips snap and lock into front panel.

Step 7: Moving Hinge strap from right side to left side (Note: on the 80Lb, the hinge back plate and the stiffener have to be moved to the posit side). Remove the four Phillips countersunk screws and the two button head Phillips screws remove hinge strap and release the hinge strap back plate.

Step 8: Remove the left side three upper and the three lower Phillips button head screws transfer the screws and the stiffener to the right side hinge position.

Step 9: move hinge strap and hinge back plate to left side, make sure side with pin is on the bottom, reinsert the four countersunk Phillips head screws and the two button head screws.

Step 10: Reinstall the switch box cover by replacing the two 3/8 nuts.



Pressure Regulator Adjustment

Use the following procedure whenever it is necessary to check the pressure regulator setting. NOTE: Any adjustment of the pressure regulator must be made with a manometer attached at the plug in the main burner manifold.

Step 1: Shut off the gas supply to the dryer.

Step 2: Remove the 1/8" pipe plug from the end of the main burner manifold.

Step 3: Attach a manometer to the manifold end.

Step 4: Remove the pressure regulator cover screw on the gas valve.

Step 5: Open the shut-off valve, and operate the dryer.

Step 6: Adjust the pressure for a manometer reading of 3.5" water column gas pressure. (11.0" for L.P.)

NOTE: The main burners must be operating when adjusting the pressure regulator.

Step 7: Shut off the gas supply to the dryer. Remove the manometer and install the 1/8" pipe plug in the manifold.

Step 8: Open the shut off valve, start the dryer and check for gas leaks while the burners are ignited.

NOTE: Always remove power from the machine before changing drive belts or working with the drive and fan system.

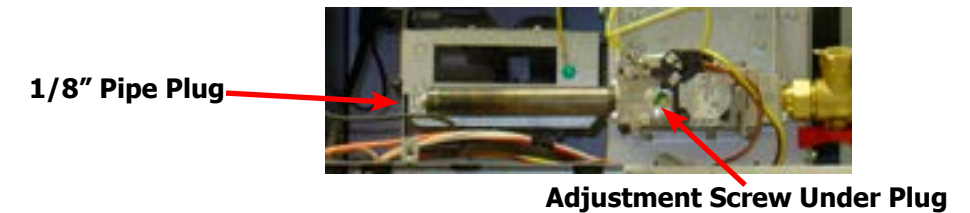

Final Drive Belt Replacement

To replace the final drive belt turn the cylinder slowly by hand and work the belt off of the large pulley.

Motor Drive Belt Replacement

To replace the motor drive belt the final drive belt should be removed as above. Next turn the intermediate drive pulley and work the belt off of it similarly to the above belt.

Blower Motor Removal

Step 1: Remove Rear upper and lower Belt pulley guards.

Step 2: Remove rear electrical box cover.

Step 3: Remove left and bottom side guard.

Step 4: Remove belts.

Step 5: Disconnect wires from the over temperature switch and cut the two wire ties securing gray wire to motor harness.

Step 6: Remove the wire clamp holding motor wire loom to cross member by removing the 5/16 screw.

Step 7: Remove the two beaded ties securing harness behind pulleys.

Step 8: Remove last wire tie connecting gray wire to motor harness.

Step 9: Next, inside the rear control box disconnect red wire, 1/4 inch quick connect inside splice connector.

Step 10: Remove black and yellow wires from R1 relay.

Step 11: Remove motor harness from control box.

Step 12: Next remove blower motor, back plate, and impeller from machine by removing the four 9/16 nuts.

Reassemble in reverse order.

Clothes Door Reversal (OPL only) 80Lb Cont.

Step 11: set door with hinge plate back onto the lower hinge strap pin first, next using 1/4" allen wrench and lower door hinge fastener and fastening with the 3/16" allen screw, next replace the inner door hinge plate cover with the two Phillips head screws.

Step 12: Reconnect Door switch harness and replace front panel in reverse operation.

Clothes Door Latch Adjustment

Step 1: Loosen the lock nut on the latching stud. It is located directly behind the door handle.

Step 2: Open the loading door.

Step 3: Screw the door catch stud in or out as necessary and then retighten the lock nut.



Installation of Clothes Door Window & Gasket

Step 1: Remove the loading door.

Step 2: Place the clothes door, with its face down, on a solid surface.

Note: Pre-warming the gasket under a heat lamp makes the installation much easier.

Step 3: Put the door glass gasket on the loading door with the ridges in the wide side up. Locate the seam at the door latching stud.

Note: The gasket has one narrow opening on one side and a wide opening on the other. The narrow side mounts to the door. The wide side holds the glass. The wide side has ridges on one interior lip. This ridged side should go up with the door lying face down.

Step 4: Coat the inside and outside of the gasket with rubber lubricant or liquid soap.

Step 5: Slide the glass into the middle of the gasket with half of the glass above the door and half below the door.

Step 6: While pressing on the glass, use a modified screwdriver (grind the end off so that it is round and put a slight bend in it) and run it around half of the glass.

Step 7: With half of the glass installed, turn the door over and repeat step 6.

Step 8: Insert the modified screwdriver at the 6 o'clock position and pry the glass up enough to install the door glass support spacer (small diameter rubber tube).



Glass inserted half way

High Limit Thermostat Locations & Functions Burner Housing

This hi-limit is located on the rear of the burner housing.

STEP 1: The thermostat opens the circuit to the main burners in the event of malfunction in the gas control area or temperature control. This thermostat will open quickly if there is a significant loss of air flow over the burner area.

STEP 2: It is held in place by two screws. There are spacers between the thermostat and bracket which must be used to give proper operation.

Removal : To remove the hi-limit thermostat on the side of the burner housing, remove the terminal of each wires attached to the thermostat. Lastly, remove the mounting screws holding the thermostat to the burner housing.

High Limit Thermostat



Manual Resettable Over Temperature Safety Thermostat

The second hi-limit thermostat is located outside the rear exhaust opening mounted on the left side of the exhaust duct at the rear outlet height.

Step 1: The manually resettable thermostat limits the operating temperature a dryer can reach should some abnormal situation occur.

Step 2: Should the thermostat be tripped, the dryer will cease to heat until the thermostat is reset. Once the dryer cools, the thermostat may be reset by pushing the button in.

REMOVAL: To remove the manual resettable over temperature safety thermostat next to the exhaust duct. First, remove the terminals of each wire attached to the thermostat. Next, remove mounting screws holding the thermostat to the dryer cabinet.

Overtemp Thermostat

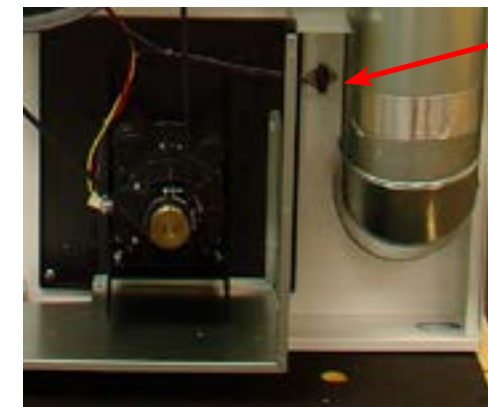

Blower Impeller Removal

Remove Blower motor assembly. Take notice of the location of the impeller location on the shaft. Remove the two set screws that hold the motor to the shaft.

Airflow switch removal and adjustment

The air switch assembly is part of the ignition safety circuit and insures that the burner doesn't operate unless ther is airflow. If this doesn't happen, ignition will not occur. The air switch assembly is located on the back of the Dryer.

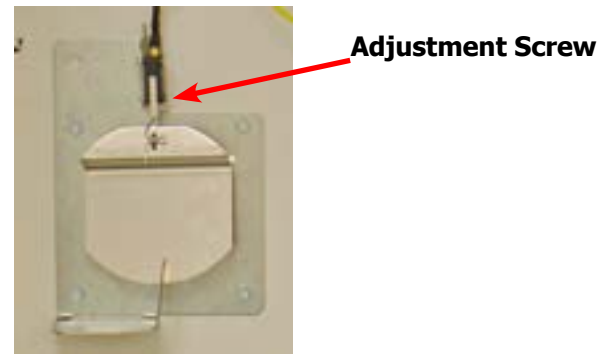

Electronic Ignition Module

This machine uses an electronic spark ignition system to directly light the burners.

Step 1: The electronic ignition module (gray box) is located inside the rear control box.

Step 2: The red wire from the transformer provides 24 VAC through the 1.5 amp fuse and into the module to operate the entire direct ignition system.

Step 3: The black colored hi-voltage wire (spark plug type) plugs onto the post connector on the module, and the multi-wire plug fits into the side of the module.



Spark Electrode Assembly-Removal

Step 1: Disconnect wires to electrodes.

Step 2: Remove two screws to detach electrode assembly.

NOTE: Proper grounding of the ignition system (yellow wires) is very critical for proper ignition sequence

If there is no spark or intermittent spark, check black hi-voltage lead wire for damage or cracks in insulation. This lead wire must not be taped or connected to any metal edges along its length to prevent pinching and arcing. Also, do not bundle this wire with other wires.

Note : Spark gap and electrode location are important. If the electrode is damaged or mounting is changed the spark gap may not be correct for ignition to occur. Check for cracks in the ceramic insulator. Replace electrode assembly if necessary. Also check for carbon or foreign material on the electrodes and clean if necessary.

Gas Valve & Manifold Removal

Step 1: Disconnect union at gas valve and disconnect wires from gas valve operator coils.

Step 2: Remove Gas Valve mounting bracket by removing the 4 5/16 screws.

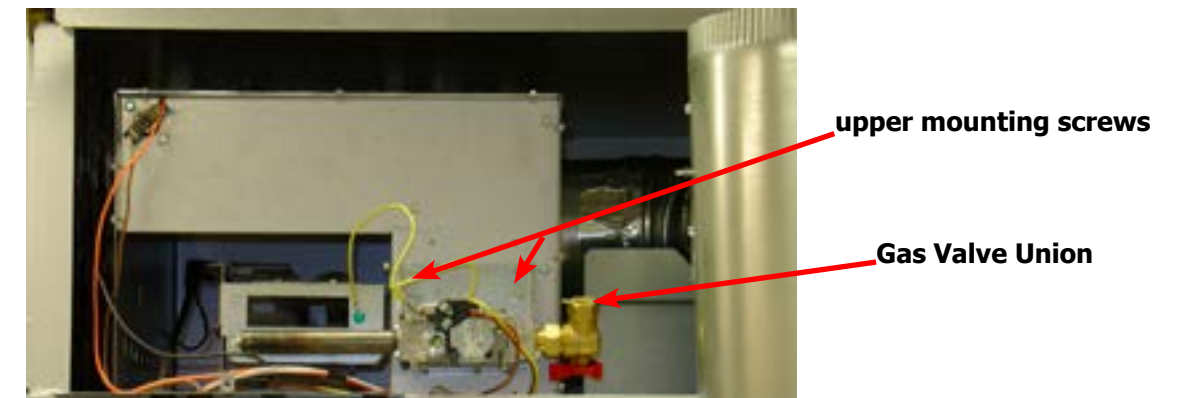

Main Burner Orifice Removal

Step 1: Remove manifold and gas valve assembly as above.

Step 2: Using an open end wrench, remove orifices from manifold.

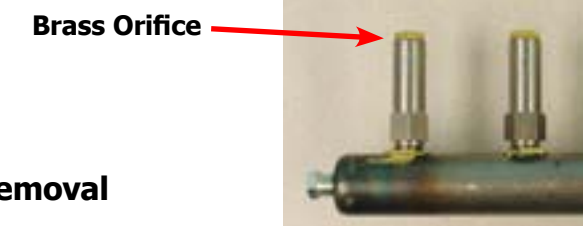

Main Burner Removal

Remove manifold & gas valve assembly as previously discussed. Remove thefour 9/16 screws securing the front of the burner to the support bracket. The burners may now be removed.

Cylinder Pulley Removal

30Lb

Remove bolt and washers holding pulley to cylinder shaft. Reincert bolt then using two or three jaw puller Pull pulley straight off of shaft.

50lb & 80Lb

Remove bolt and washers holding pulley to cylinder shaft. Reincert bolt then using "T" puller w/ 3/8-16UNC bolts, Pull pulley straight off of shaft

Intermediate Pulley Removal

30Lb & 50Lb

The intermediate pulley can be removed by removing the snap ring holding the pulley to the tension arm.

Note: Cylinder pulley must be removed first.

80Lb

The intermediate pulley can be removed by removing the nut holding the pulley to the tension arm.

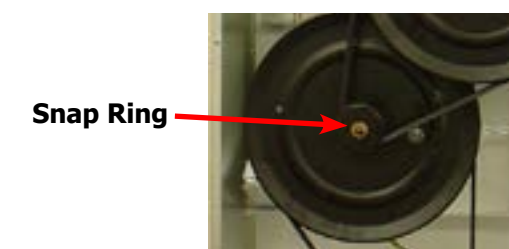

Tension Arm Assembly Removal

The tension arm assembly may be removed by removing the snap ring that holds it to the tension arm support assembly pin. If it is necessary the arm assembly is replaced as a complete unit.



Tension Arm Support Assembly Adjustment

The tension arm support assembly may be adjusted for alignment of the intermediate pulley and also to align the belts. The three outer nuts allow the alignment of the pin to be adjusted by pivoting the assembly on the center bolt. The center bolt can be screwed in to allow bringing the complete assembly farther back if necessary for belt alignment.

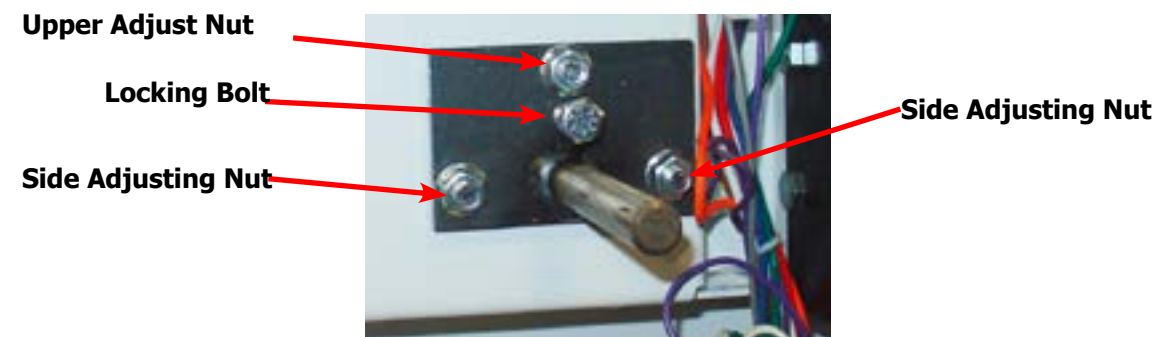

Cylinder Removal

- Step 1:** Remove the front panel in front of the cylinder.
- Step 2:** Remove drive belt, bolt, washers, and pulley.
- Step 3:** Pull the cylinder from the front of the machine.

Adjustment of Cylinder Assembly

- Step 1:** Loosen the two top adjusting bolts and two bottom adjusting nuts and lock nuts holding the bearing housing to the drive plate.
- Step 2:** Loosen the four mounting bolts on the side channels.
- Step 3:** Open the clothes door and insert a 1/2" thick shim at the 3 and 9 o'clock positions and a 1/4" thick shim at the 6 o'clock position.
- Step 4:** Tighten the two bottom adjusting nuts and tighten locking nuts.
- Step 5:** Tighten the bottom right mounting bolt, then the top left mounting bolt. Tighten the remaining two bolts. (Shim where and if necessary.)
- Step 6:** Tighten the two top adjusting bolts.
- Step 7:** Remove all the shims from between the front panel flange and cylinder (3,6,9 and 12 o'clock).
- Step 8:** Spin the cylinder to check for rubbing baffles, pressing down hard while rotating. If rubbing is detected, repeat procedure paying particular attention to placement of shims between bearing housing and side channels.

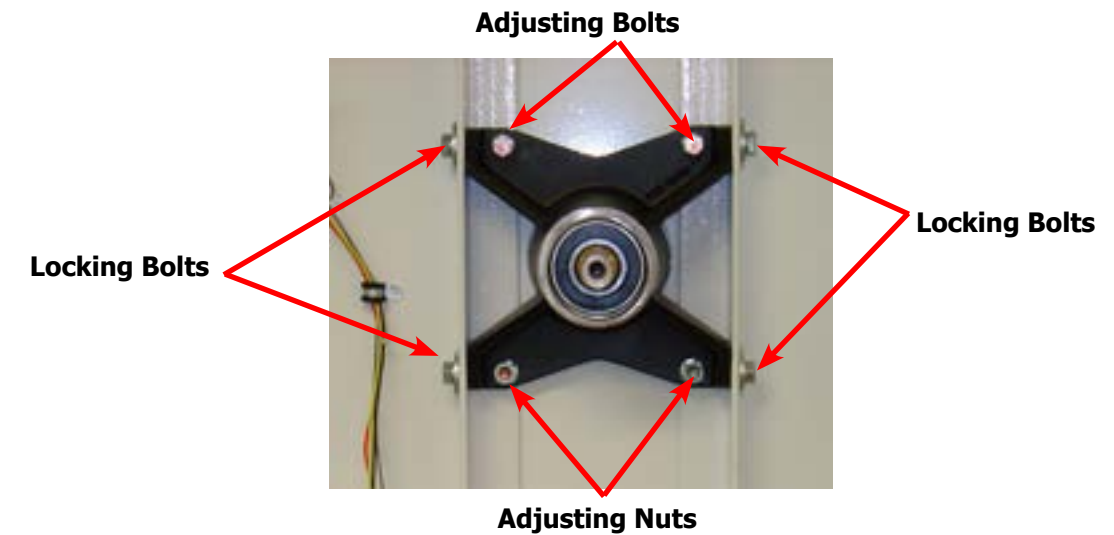

Bearing Housing Removal

After removing cylinder as previously outlined, simply unbolt the four outside bolts and the two lower nuts and remove the bearing housing.

Spark Electrode Assembly-Function

Step 1: The spark electrode and sensing electrodes are located directly at the side of the burner housing.

Step 2: The electrode with the black hi-voltage wire conducts the spark to the center grounding probe, directly over the burner.

Step 3: The electrode with the black sensing wire detects ignition and monitors flame by signaling the module.

NOTE: Proper grounding of the ignition system (yellow wires) is very critical for proper ignition sequence.

Ignition System-Function & Sequence

During normal dryer operation, the following occurs:

1. The dryer electronic control calls for heat.

2. From the 24VAC control transformer, voltage for the heat circuit is applied to the control through the door switch. If the control detects that the heat should be on, a circuit is closed providing power through the over-temp thermostat, the air damper switch, the high limit switch and the motor centrifugal switch to the Ignition Module.

3. Once the 24VAC reaches the ignition module on the red, sparking occurs at the ignition electrode and 24VAC is applied to open the Gas Valve.

3. Once the flame is established, the sensing electrode detects the presence of flame and the sparking stops.

4. If for any reason the flame is not established in a period of 10 seconds, the electronic control will try this sequence for 3 tries. Normally the 10 seconds "Trial For Ignition" period is ample to establish and prove flame.

5. If the flame is shutdown or blown out during operation, the ignitor will immediately go into "Trial. For Ignition" again for 10 seconds.

6. However, at the end of 3 separate retries of 10 seconds "Trial for Ignition", the flame is not established, the ignition system goes into "Safety Lock-Out" and will not reactivate the "Trial for Ignition" until there is a current interruption for a period of 15 seconds. This interruption can be provided by opening the dryer loading door and allowing the machine to come to a complete stop for 15 seconds.

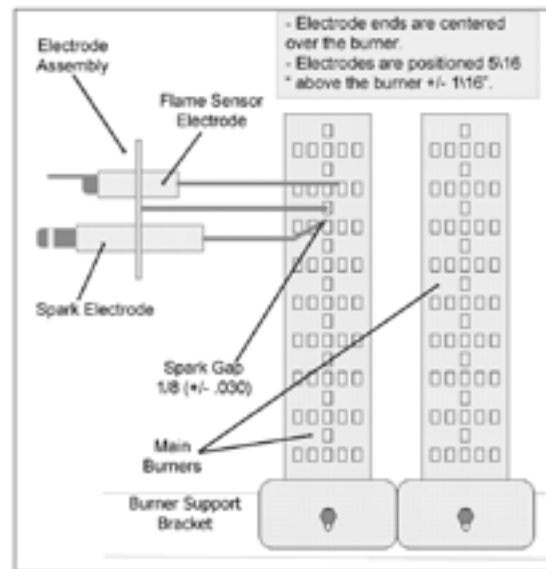

Dryer Trouble Shooting

Symptom	Probable Cause	Suggested Remedy
Tumbler does not turn	Drive belts	Check both drive belts. Replace if failed.
	Tumbler does not turn	Check Variable frequency drive for faults. Turn of power supply to reset machine.
	Door switch	Check door switch contacts and adjustment. Adjust or replace door switch.
	Control or Start Switch	Check to see if time on the control is counting down.
Tumbler turns but no spark at burner	Glass fuse	Check small glass control fuse in back of dryer. Replace if failed.
	Thermostat	Check if voltage is passing through the two wires attached to the thermostat.
	Ignition Control	Check for 24VAC output from transformer.
	Transformer	Replace if have 120V between black & white and no 24V between red and yellow.
	Over temperature thermostat	Check to see if manually resettable thermostat. Thermostat is kicked out. Reset by pushing red reset button.
	Ignition control	Check for 24VAC coming into the control on the red wire. If voltage, then check for 24VAC on the brown wire. Also check for spark at the ignitor. If no 24VAC output or no spark to the ignitor, replace ignition control.
	Air Flow Switch	Check air flow switch to be sure it closes when dryer is running. If not, adjust or replace switch.
	Hi-limit	Check for continuity. Should be 0 ohms resistance when cold. If not, replace thermostat.
	Gas supply	No gas can cause the system lockout.

Dryer Trouble Shooting

Symptom	Probable Cause	Suggested Remedy
Tumbler turns, ignition sparks, no flame	Gas supply	Make sure gas supply is working.
	Gas pressure	Check gas pressure with a manometer. Adjust if necessary.
	Spark Electrode Sensor	Check for damage to electrode or mounting. Check to ensure that sparking occurs. Replace if necessary.
	Gas valve	Check coil continuity, replace valve if failed.
	Ignition Control	Check for 24VAC to gas valve coils. If no voltage replace ignition control.
Burner Lights, but goes on and off	Electrode	Check low voltage harness for possible wire break or cuts to allow no signal back to ignition control. Replace Ignition electrode assembly.
Slow drying	Temperature Setting	Check thermostat for correct high temperature setting. Adjust if necessary.
	Air flow restrictions necessary	<ol style="list-style-type: none"> 1. Check lint screen and clean if necessary. 2. Check exhaust for correct length and clean if necessary. 3. Check exhaust damper to insure that it opens when dryer is running and closes when dryer is not in use. 4. Check makeup air to insure that it is adequate. Increase makeup air if necessary. 5. Check static Back pressure no more than .3wc
Manual overtemp Tripping Frequently	Recirculating chamber Lint Accumulation	Remove manual overtemp thermostat and inspect in chamber for excessive lint build up. Access also gained to this chamber by removing recirculation duct mounted at bottom of chamber, or the panel inside burner chamber between burners and rear back panel
	Exhaust ducting Excessive lint buildup	Remove exhaust duct at rear of dryer and inspect for excessive lint build up in complete duct from dryer to where duct exits building.
	Clean lint from top heat air chamber above tumbler	Remove front panel completely. Be careful of any wiring attached. Remove heated air chamber cover and clean above tumbler back to burner housing.

REVERSING DRYER FAULT CODES

FAULT #	FAULT DESCRIPTION	ACTION
F1	Shorted thermostat sensor.	Dryer stops and "F1" flashes on the 4-digit display. When short circuit on sensor input is removed, "LOAd" appears on the 4-digit display and the remaining dry time is reset.
F2	Open thermostat sensor.	Dryer stops and "F2" flashes on the 4-digit display. When a good sensor is connected to sensor input, "LOAd" appears on the 4-digit display and the remaining dry time is reset.
F3	EEPROM corrupted	Dryer will not start and "F3" appears on the 4-digit display. The power to the dryer must be cycled to reset the controller. Fault should only occur when starting a dry cycle.
F4	Gas valve on fault.	The drying temperature did not increase 1°F. in 5 minutes. "F4" will flash on the display and the dry cycle will finish without calling for heat (energizing gas valve). Opening the door or pressing the STOP touch pad switch will reset the fault and clear the remaining time in the dry cycle.
F5	Temperature fault	The drying temperature is at least 25°F. above the temperature setting. "F5" will flash on the 4-digit display and the dry cycle will finish without calling for heat (energizing the gas valve). The power to the dryer must be cycled to reset the controller.

Kits, Assemblies, & Common Parts

Description	Part Number
Kit T80 Bottom Exhaust	9732-348-001
LP to Natural Gas Conversion for White Rodgers	9732-142-004
Kit, Optional Replacement for Round Switch 9539-492-001	9732-351-001
Temperature Probe	9501-004-002
Kit-30/50/80 OPL, PCB-Controller	9732-249-001
Ignition Control Box	9857-182-001
Electrode Assembly, Ignition	9875-002-003
Thermostat, Hi-Limit	9576-203-002
Thermostat, Overtemp	9576-207-006
Motor Run Relay	5192-299-002
Transformer	8711-007-002
Lint Screen	9822-031-002
Air Flow Switch	9539-461-009
Door Switch	9539-492-001
Motor Belt	9040-076-003
Tumbler Belt	9040-073-012
Tension Arm Complete	9861-024-002
Spider/Trunnion	9873-008-001
Door Handle	9244-082-001



DCBD80HC_-10BD
DN0080NC-10EB2R

Section 5: Dryer Parts Data

Dryer Cabinet Group

Key	Description	T80	
1	Loading Door Complete SS/Brushed SS/Blk	9960-305-001	1
1	Loading Door Complete Wht/Brushed SS/Blk	9960-305-003	1
2	Door Assy, Loading (Ring only) Brushed SS	9960-284-002	1
3	Plate Assy, Hinge (SS)	9982-368-001	1
3	Plate Assy, Hinge (Wht)	9982-368-003	1
*	Cover-Hinge Back, Black	9074-340-002	1
*	Screw-10Bx3/8, Black	9545-008-010	2
*	Screw Hinge to Door	9545-012-015	4
*	Nut, Hinge to Door	8640-413-002	4
4	Glass, Door	9212-002-004	1
5	Gasket, Door Glass (Black)	9206-413-002	1
*	Support Door Glass	9548-117-000	2
6	Gasket, Door Outer Rim (Black)	9206-420-005	1
7	Handle, Loading Door	9244-082-001	1
*	Screw, Handle	9545-018-017	2
8	Stud Door Catch	9531-033-003	1
9	Nut-Hex, #10-32	8640-413-001	1
10	Nut, Acorn	8640-413-003	1
*	Catch, Loading Door	9086-015-002	2
*	Rivit	8638-190-009	4
11	Strap, Hinge (Black)	9966-014-002	1
*	Plate Assy-Backup, Hinge	9982-369-001	1
*	Reinforcement-Front panel	9817-003-001	1
12	Screw-Phillips, 10-32x1/2 Chrome	9545-012-003	8
*	Screw-Phillips-Counter sink, 10-32x1/2 Chrome	9545-012-028	4
13	Screw-Special, Hinge to Door	9545-052-001	1
*	Nut-Allen, 1/4-20	8640-439-001	1
14	Washer-Fiber/Plastic	8641-436-003	1
15	Front Panel Assy (SS)	9454-868-001	1
15	Front Panel Assy (Wht)	9454-868-003	1
16	Screw-Phillips, 10Bx1 3/4	9545-008-014	4
17	Washer-Finish	8641-585-001	4
*	Nut-Spring	8640-399-001	4
*	Insulation-Front Panel, Top Half	9277-058-001	1
*	Insulation-Front Panel, Bottom Half	9278-058-002	1
18	Label-Warning	8502-753-001	1
19	Plug-Front Panel	9456-050-001	1
*	Switch-Door Closed	9539-492-001	1
*	Wire-Assy, Blk	8220-063-026	1
*	Wire-Assy-Blu	8220-063-009	1
*	Cover-Door Switch	9074-351-001	1
*	Nut-#10-32unf, 2B	8641-413-002	2
*	Cabinet Touch Up Paint (White)	9472-001-013	1

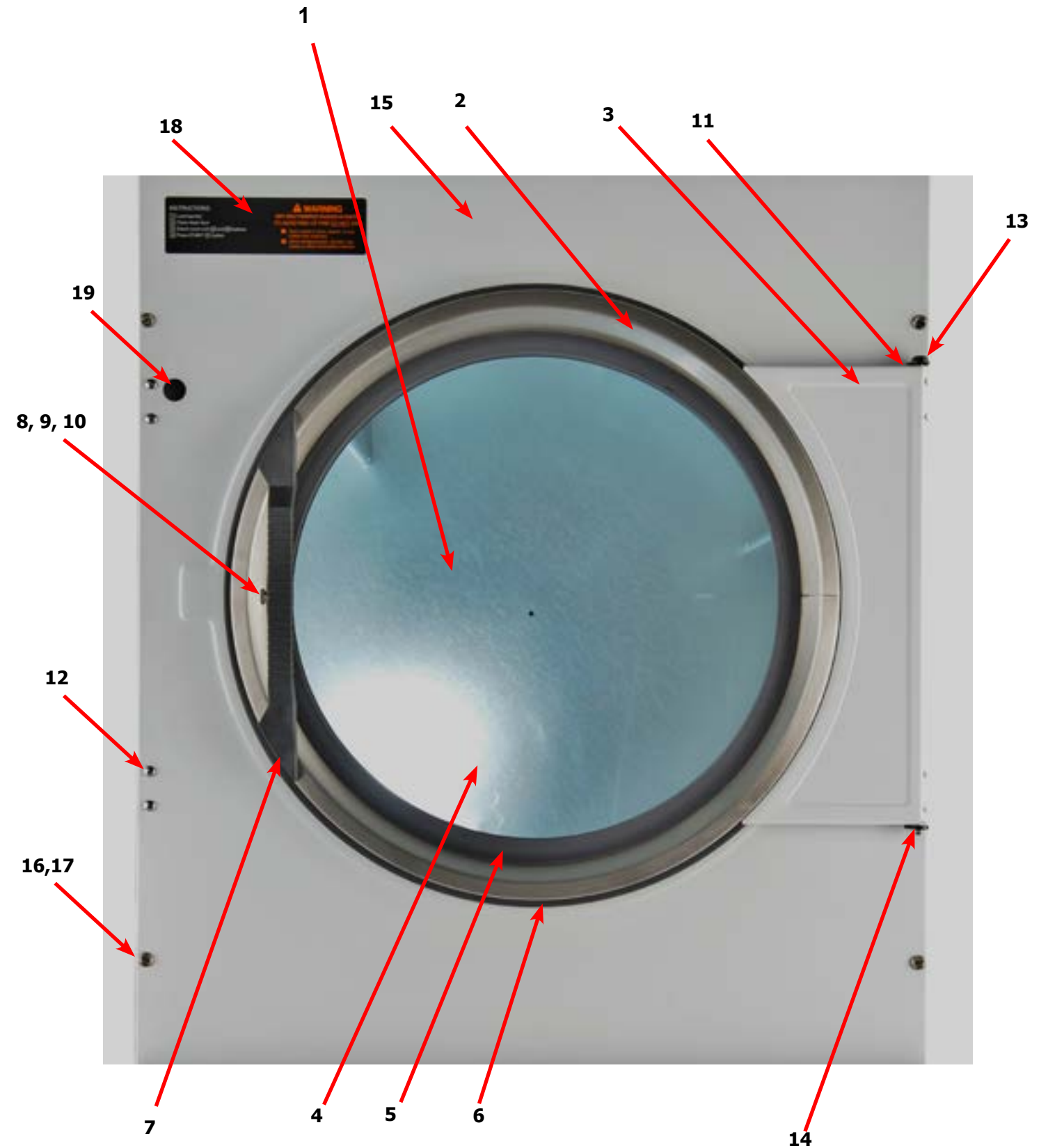

Dryer Cabinet Group Continued

Key	Description	T80	QTY
1	Nameplate - Dexter Dryer Black	9412-196-001	1
2	Door Assy-Upper, OPL (SS)	9960-292-001	1
2	Door Assy-Upper, OPL (Wht)	9960-292-003	1
*	Bracket-Hinge	9029-224-001	2
*	Rivit- 3/16, Hinge to Door	9491-009-001	2
*	Rivit- 3/16, Hinge to Cabinet	9491-009-001	AR
3	Trim-Upper Service Door, Black	9578-096-002	1
4	Screw-Phillips, 10Bx3/8, Black	9545-008-010	4
5	Screw-Phillips, 10Bx1 3/4	9545-008-014	2
6	Washer-Finish	8641-585-001	2
*	Nut-Spring	8640-399-001	2
7	Membrane Switch	9801-103-001	1
8	Kit-30/50/80 OPL, PCB-Controler	9732-249-001	1
*	Spacer-#6 x 1/2	9538-157-015	4
9	Nut- #6-32	8640-411-003	4
10	Wire Assy-GRN, 24"	8220-137-001	1
11	Fuse, .600MA/250V	8636-024-001	1
12	Support-Upper Service Door	9548-288-002	1
13	Clamp-Tube	9079-121-002	2
14	Nut, #6-32	8640-411-003	2
15	Clamp-Cable, 1/2"	8654-126-004	1
16	Nut, #6-32	8640-411-003	1
17	Insulation	9277-041-016	1
*	Harness-Control	9627-770-003	1
*	Harness-Temp Probe	9627-679-002	1

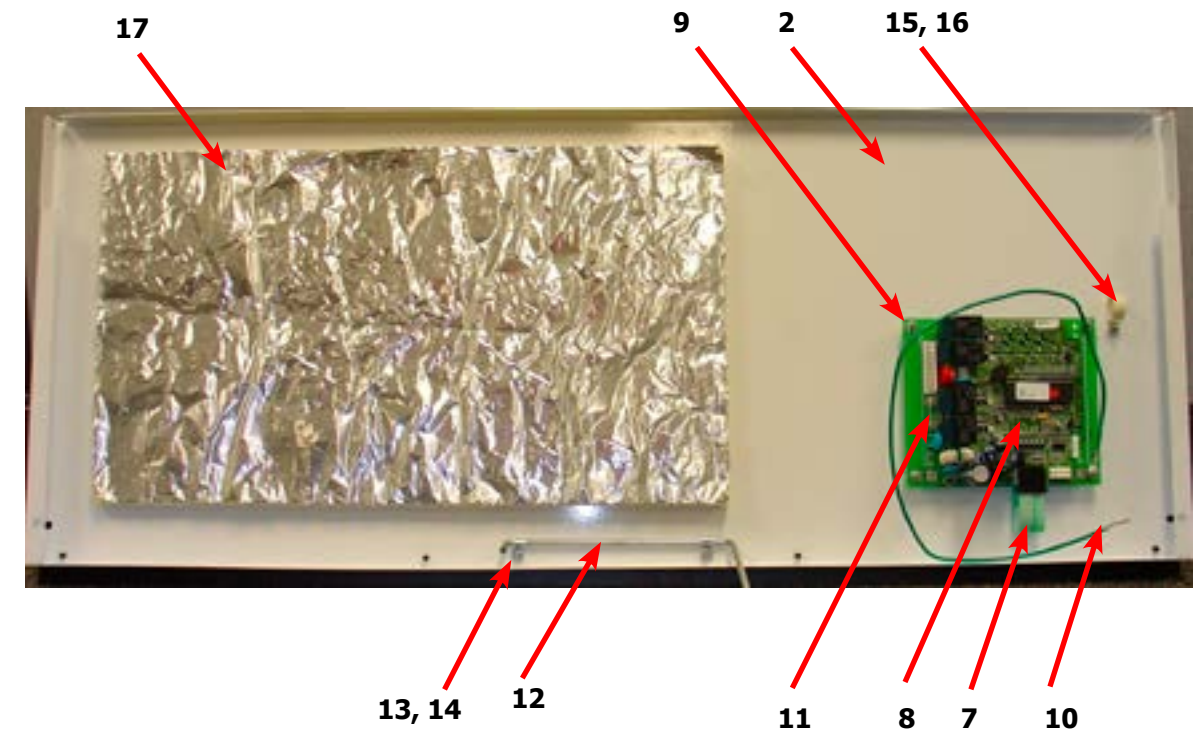

Dryer Cabinet Group Continued

Key	Description	T80	QTY
1	Door-Lower Service, OPL, SS	9108-127-001	1
1	Door-Lower Service, OPL, Wht	9108-127-003	1
2	Handle-Door, Lower Service, Black	9244-088-002	1
3	Screw-Phillips, 10Bx3/8, Black	9545-008-010	5
4	Handle-Door, Lower Service OPL	9244-084-002	1
5	Trim-Lower Kick, Black	9578-097-002	1
6	Screw-Phillips, 10Bx3/8, Black	9545-008-010	4
7	Screen Assy, Lint	9822-031-002	1
8	Switch-Door Closure (Round)	9539-492-001	1
8	Switch-Door Closure (Square)	9539-501-001	1
*	Kit, Optional Replacement for Round Switch 9539-492-001	9732-351-001	1
9	Hinge-Door, Lower	9243-082-001	1
10	Screw-5/16, 10ABx3/8	9545-008-024	5
11	Bracket-Door Switch	9029-226-001	1
*	Rivit, 1/8 Low Profile	9491-009-004	2
12	Bracket-Chain	9029-223-001	2
*	Rivit, 1/8 Low Profile	9491-009-004	8
13	Hook, "S" Type	9248-022-002	4
14	Chain-Lower Service Door	9099-012-006	2
*	Leg, Leveling 1/2"	8544-006-001	4
*	Leveling Leg Wrench	8545-061-002	1

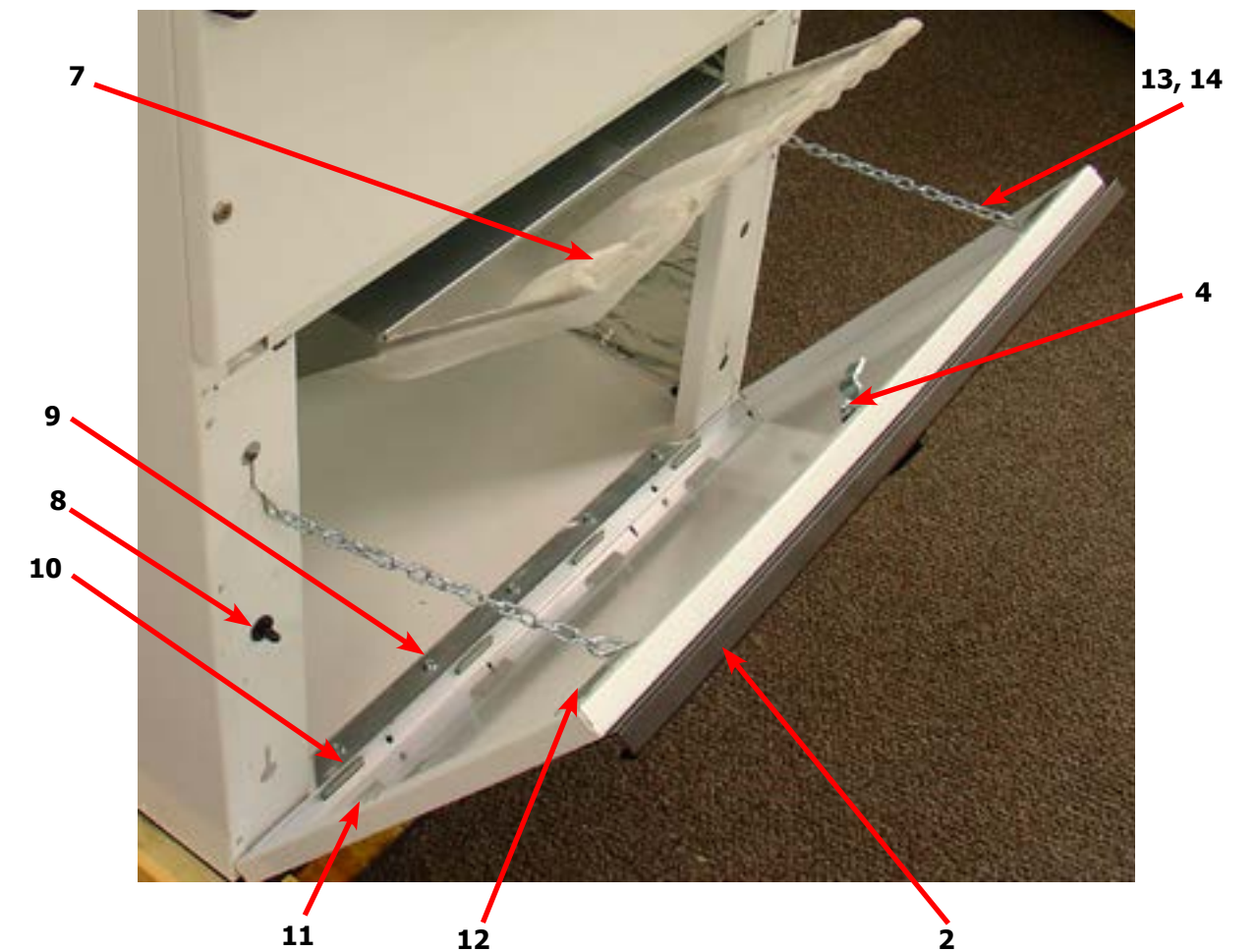
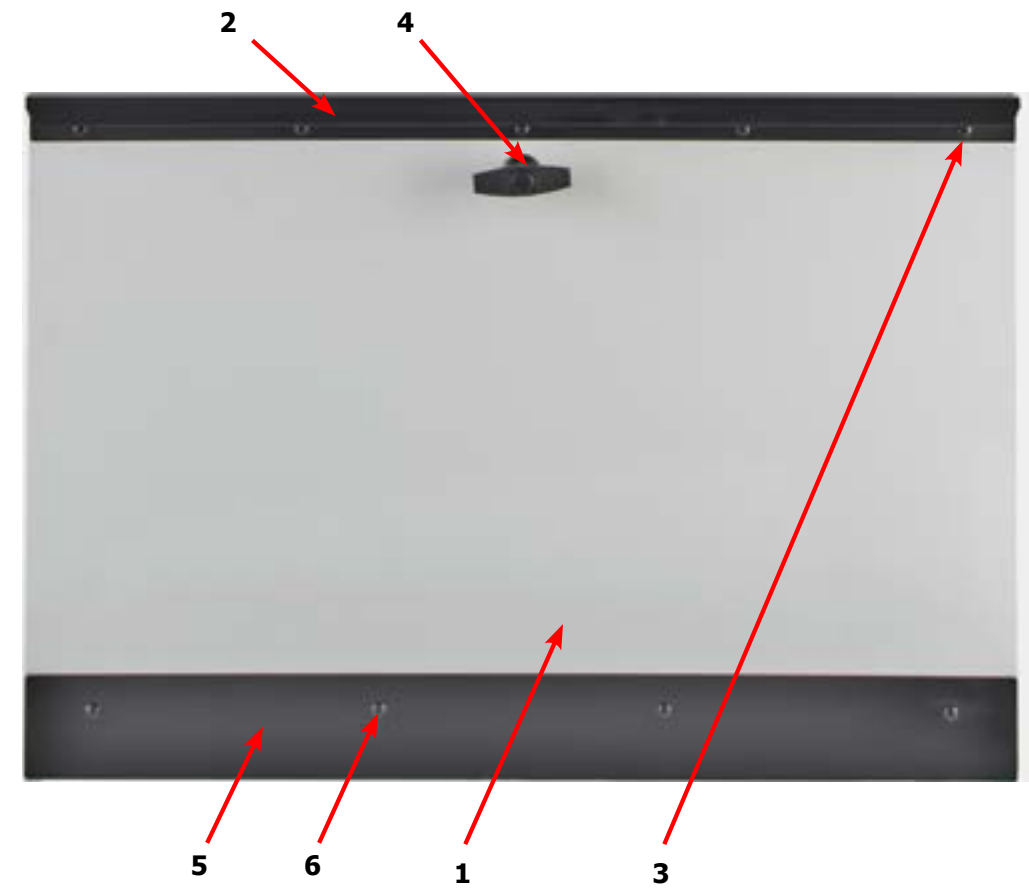

Dryer Cabinet Group Continued

Key	Description	T80	QTY
1	Insulation, Upper service Door	9277-041-016	1
2	Insulation, RH Burnner	9277-041-023	1
3	Insulation Tumbler Area, above Baffel	9277-041-021	2
4	Insulation Tumbler Area, below baffel	9277-051-004	6
5	Insulation Lint Compartment	9277-041-025	2
*	Screen Assy, Lint	9822-031-002	1
6	Switch-Door Closure (Round)	9539-492-001	1
6	Switch-Door Closure (Square)	9539-501-001	1
7	Hinge-Door, Lower	9243-082-001	1
8	Screw-5/16, 10ABx3/8	9545-008-024	AR
9	Lint Hood-Back	9240-044-001	1
10	Nut Wizlock, 8-32	8640-412-004	6
11	Lint hood, LH	9240-046-001	1
12	Lint hood, RH	9240-046-002	1
13	Lint hood, Top	9240-045-001	1
14	Screw, 5/16- 10ABx3/8	9545-008-024	14
15	Impeller, w/set screws	9278-037-003	1
16	Harness -Temp Probe	9627-679-002	1
17	Wire Nut, #71B	8640-276-005	2
18	Temp Probe	9501-004-002	1
19	Screw-Phillips, 8Bx1/4	9545-045-005	1

50Lb & 80Lb Temp Probe

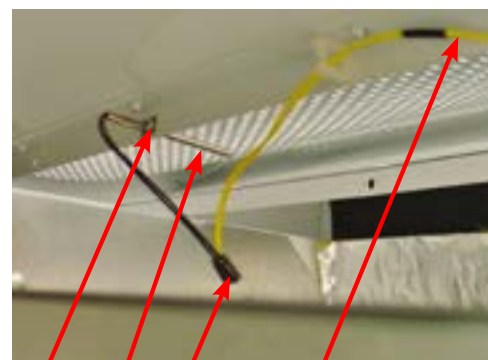

19 18 17 16

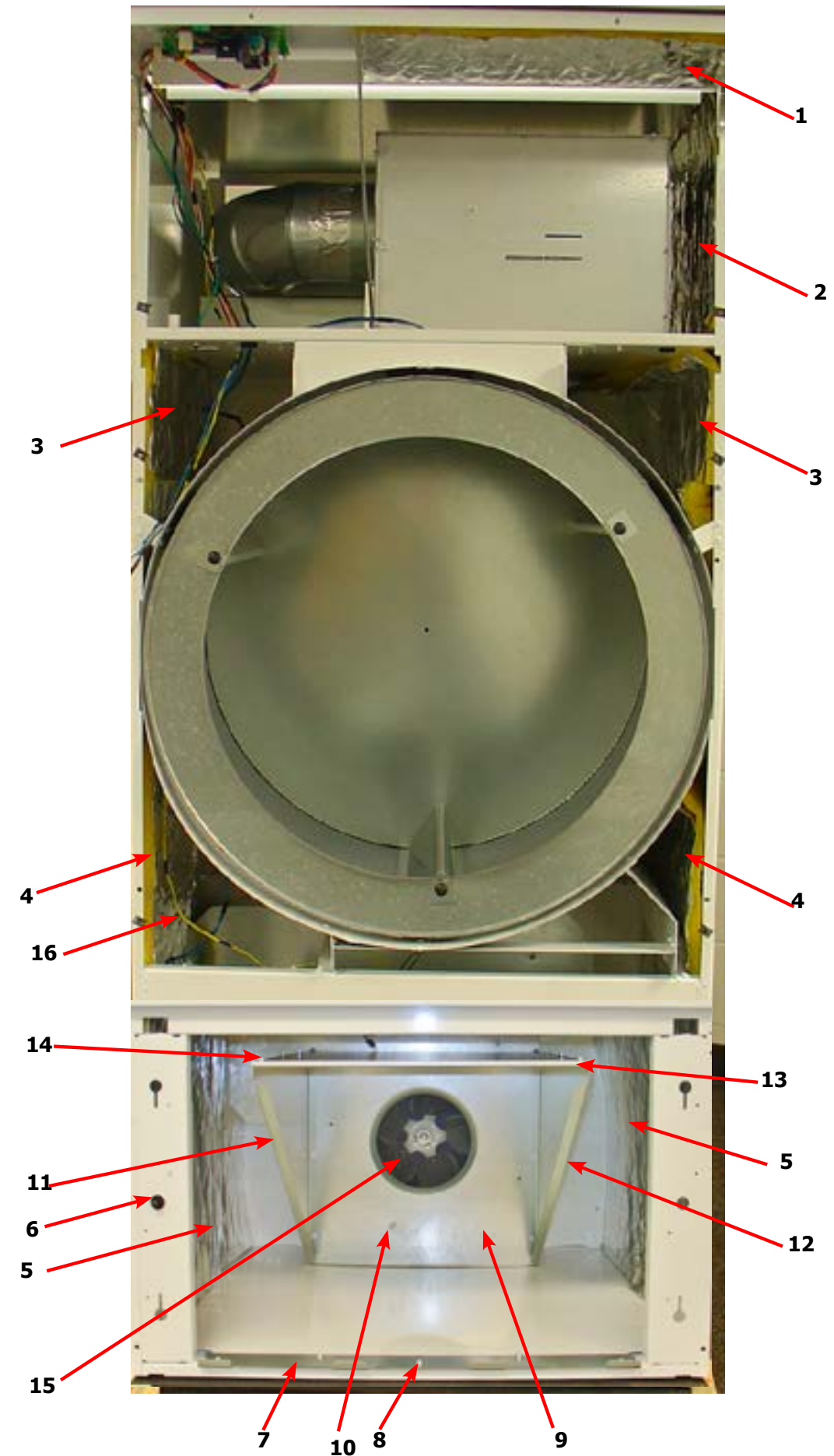

Dryer Rear View 80 Lb Reversing

Key	Description	T-80	QTY
1	Plate-Motor Mounting, Reversing	9982-373-002	1
2	Screw-Hex cap,3/8-16x1"	9545-029-005	4
3	Nut-Wizlock, 3/8-16	8640-415-004	4
4	Motor-Drive, Inverter	9376-307-003	1
*	Bushing-Motor mounting	9053-074-002	2
5	Rod-Motor Mounting	9497-222-008	1
6	Collar-s/Set Screws	9076-052-002	2
7	Pulley-Motor Drive	9453-169-012	1
*	Screw-Set, 5/16-18x1/2"	9545-028-013	2
8	Chain-Motor Tension	9099-012-008	1
9	Spring, Motor Tension	9534-319-002	1
10	Motor, Blower	9376-322-001	4
*	Run Capacitor, Motor	5191-108-002	1
*	Start Capacitor, Motor	5191-109-002	1
*	Screw HXCAP, 3/8-16x3/4 (Motor mounting to Plate)	9545-029-008	4
*	Lock-Washer, 3/8" (Motor mounting to Plate)	8641-582-003	4
11	Plate, Motor Blower	9982-352-002	1
*	Gasket, Motor Plate	9206-428-001	1
12	Nut-3/8-16, Plate to cabinet	8640-415-004	4
*	Impeller w/set screw	9278-037-003	1
*	Tolerance Ring	9487-234-001	1
13	Pulley, Driven	9908-043-002	1
14	Washer-Flat, 1/2	8641-581-026	1
15	Washer-Lock, Ext. tooth, 1/2	8641-582-016	1
16	Bolt-3/4, 1/2-13x1/14	9545-017-009	1
*	Support Arm, Intermediate pulley	9991-053-002	1
*	Bolt- 3/8-16x1 1/4	9545-029-010	3
*	Nut, Wizlock, 3/8x16	8640-415-004	3
*	Cap Screw, 3/8-16x1 1/2	9545-029-012	1
*	Snap Ring	9487-200-003	1
*	Washer-Flat, 3/8x1	8641-581-035	1
*	Idler Arm Assembly	9861-024-002	1
*	Snap Ring	9487-200-006	
*	Washer-Flat, 3/8x1	8641-581-039	1
17	Pulley, Idler w/Bearings	9908-042-006	1
*	Snapring, Inside-Bearing	9487-238-005	1
18	Bearing, Ball	9036-159-007	2
*	Spacer, Bearing	9538-173-002	1
19	Washer-Flat	8641-581-039	1
20	Nut, 5/8-11	8640-425-002	1
*	Hook "S" type	9248-022-002	3
*	Chain, Spring tension	9099-012-009	1
*	Spring, tension	9534-151-000	1
21	Belt Drive	9040-076-003	1
22	Belt, Driven	9040-073-012	1
23	Thermostat-Overtemp, Reset	9576-207-006	1

Dryer Rear View 80 Lb Reversing

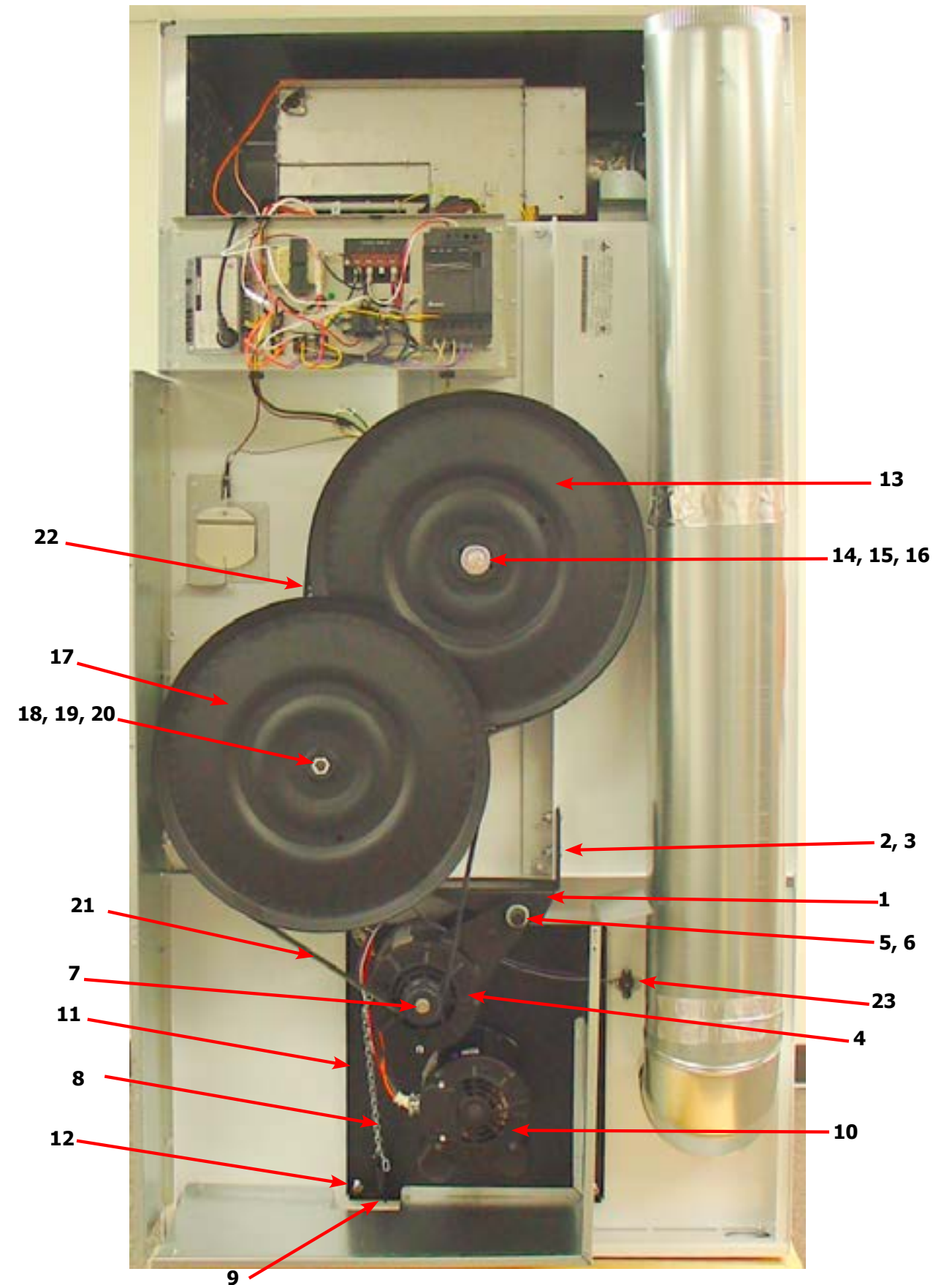

Dryer Rear View 80 Lb Reversing Continued

Key	Description	T-80	QTY
1	Plate-Motor Mounting, Reversing	9982-373-001	1
2	Screw-Hex cap,3/8-16x1"	9545-029-005	4
3	Nut-Wizlock, 3/8-16	8640-415-004	4
4	Motor-Drive, Inverter	9376-307-003	1
*	Bushing-Motor mounting	9053-074-002	2
5	Rod-Motor Mounting	9497-222-008	1
6	Collar-s/Set Screws	9076-052-002	2
7	Pulley-Motor Drive	9453-169-012	1
*	Screw-Set, 5/16-18x1/2"	9545-028-013	2
8	Chain-Motor Tension	9099-012-008	1
9	Spring, Motor Tension	9534-319-002	1
10	Motor, Blower	9376-322-001	1
*	Capacitor, Motor Run	5191-108-002	1
*	Capacitor, Motor Start	5191-109-002	1
*	Screw HXCAP, 3/8-16x3/4 (Motor mounting to Plate)	9545-029-008	4
*	Lock-Washer, 3/8" (Motor mounting to Plate)	8641-582-003	4
11	Plate, Motor mounting	9982-352-002	1
*	Gasket, Motor Plate	9206-428-002	1
12	Nut-3/8-16, Plate to cabinet	8640-415-004	4
*	Impeller w/set screw	9278-037-003	1
13	Support Arm, Intermediate pulley	9991-053-002	1
14	Bolt- 3/8-16x1 1/4	9545-029-010	3
15	Nut, Wizlock, 3/8x16	8640-415-004	3
16	Cap Screw, 3/8-16x1 1/2	9545-029-012	1
*	Snap Ring	9487-200-003	1
*	Washer-Flat, 3/8x1	8641-581-035	1
17	Idler Arm Assembly	9861-024-002	1
*	Snap Ring	9487-200-006	1
*	Washer-Flat, 3/8x1	8641-581-039	1
18	Hook "S" type	9248-022-002	3
19	Chain, Spring tension	9099-012-002	1

Dryer Rear View 80 Lb Reversing Continued

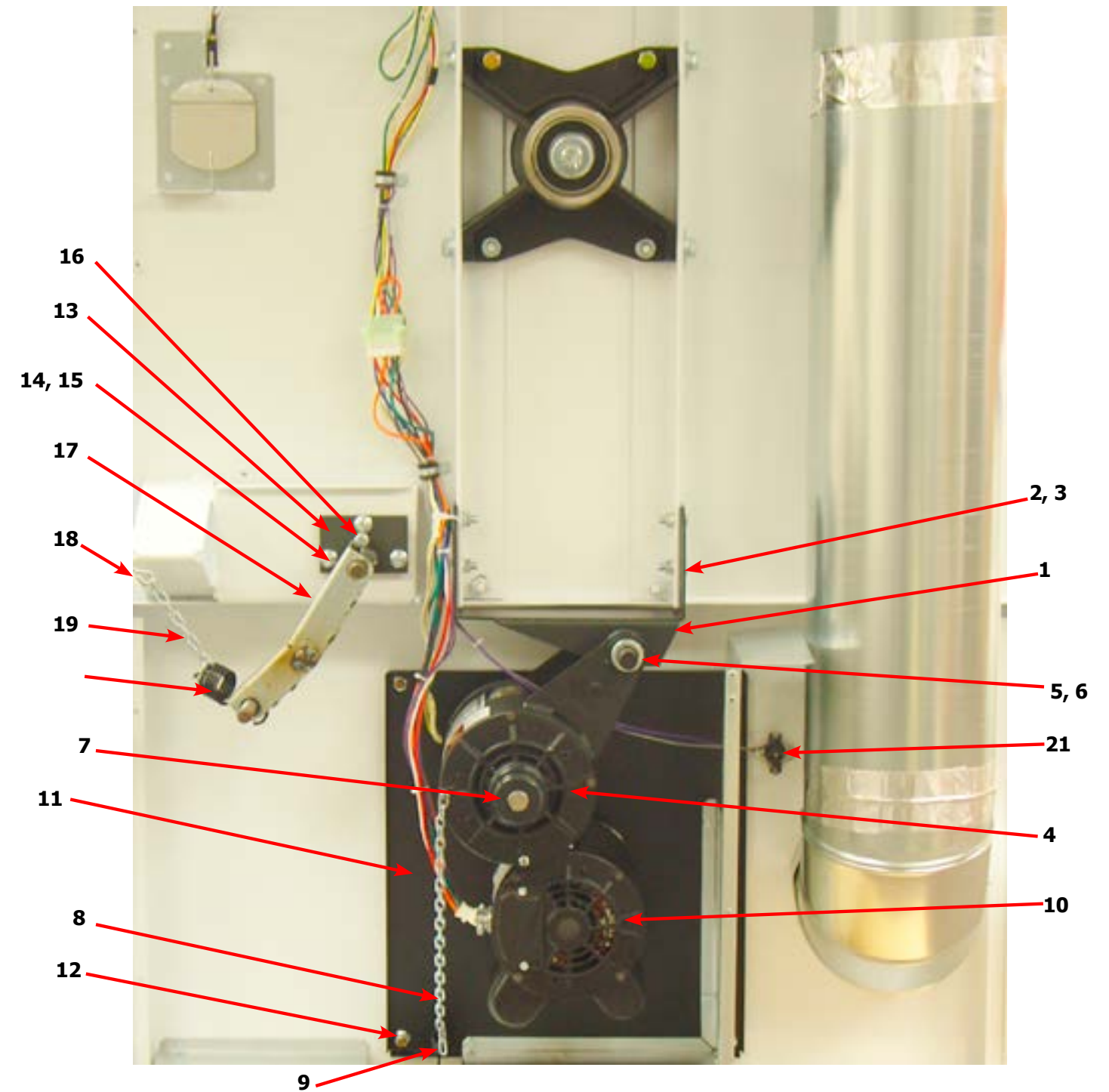

Dryer Rear View-Guard & Exhaust

Key	Description	T80	QTY
1	Cover Cabinet	9074-349-001	1
*	Screw-5/16, 10ABx3/8	9545-008-024	AR
2	Cover-Control Box	9074-353-001	1
3	Screw-5/16, 10ABx3/8	9545-008-024	AR
4	Guard, RH	9208-101-001	1
*	Screw-5/16, 10ABx3/8	9545-008-024	AR
5	Guard Base & LH	9208-102-001	1
*	Screw-5/16, 10ABx3/8	9545-008-024	AR
6	Guard-Lower	9208-103-001	1
7	Screw-5/16, 10ABx3/8	9545-008-024	AR
8	Guard-upper	9208-105-001	1
*	Screw-5/16, 10ABx3/8	9545-008-024	AR
9	Elbow-90 degree, 8"	9142-039-001	1
10	Pipe-Duct, 8"	9109-121-002	1
11	Tee-Duct, Recirculation, 8"-6"	9810-019-001	1
12	Damper	9125-008-001	1
*	Pin-Damper, Hinge	9451-146-002	1
*	Nut-Spring	8520-141-000	2
13	Bracket-Recirculation Duct, Small	9029-228-001	1
14	Pipe-Duct, 6"	9109-122-003	1
15	Bracket-Duct, Recirculation Large	9029-247-001	1
16	Elbow-90 degree, 6"	9142-039-002	1
*	Booklet-Owners	8514-210-001	1
17	Diagram & Schematics	9506-476-001	1
18	Label-Warning & Notice	8502-600-001	1
19	Label-Instructions	8502-645-001	1
20	Decal-Lighting & Clearance	8527-151-001	1
21	Label-High Voltage	8502-614-004	1
*	8" Slide Open Clean Out Duct (Optional)	9973-034-001	1

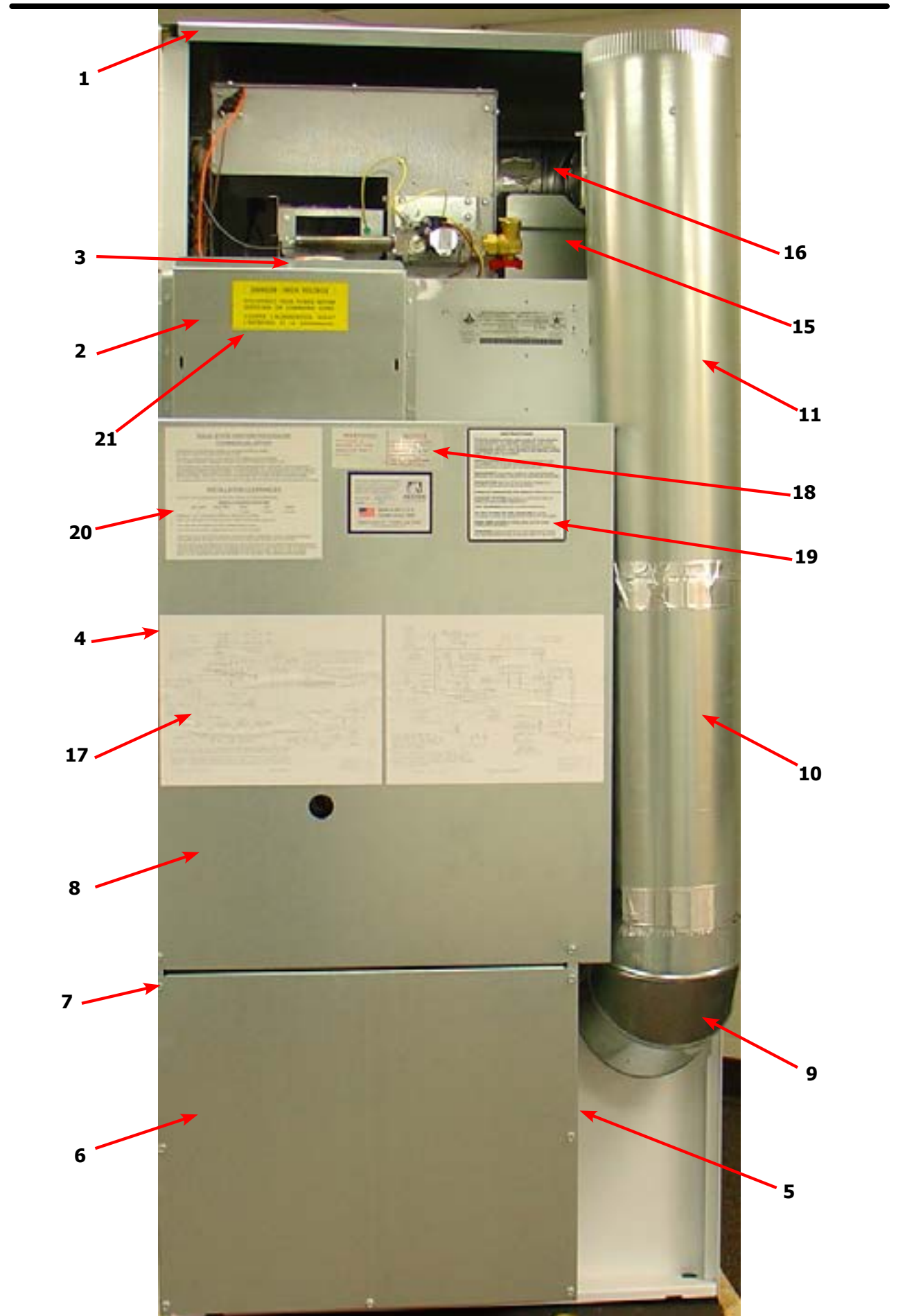
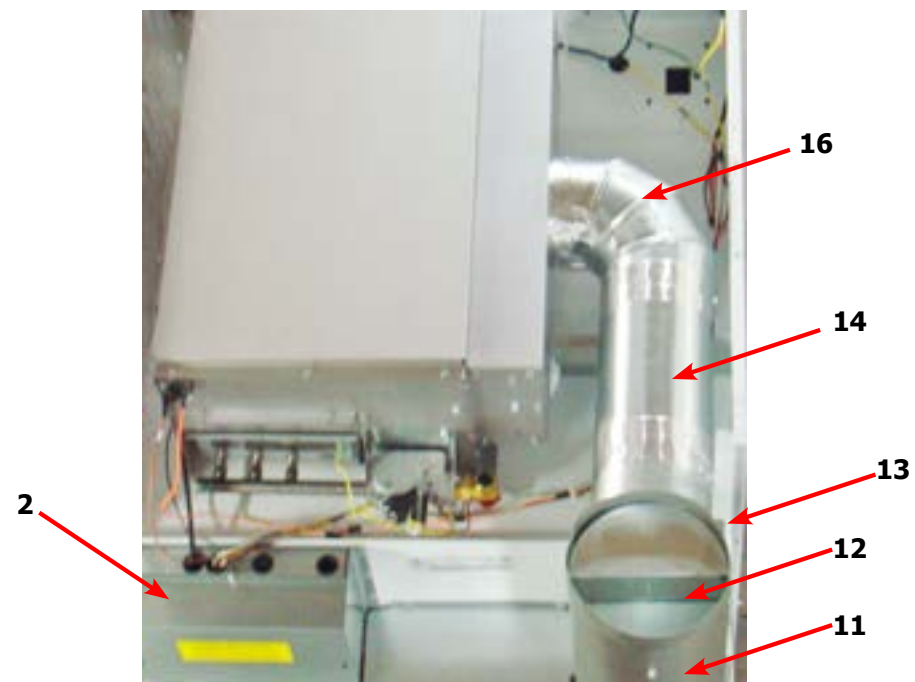

Dryer Rear View-Bearing Housing 80Lb

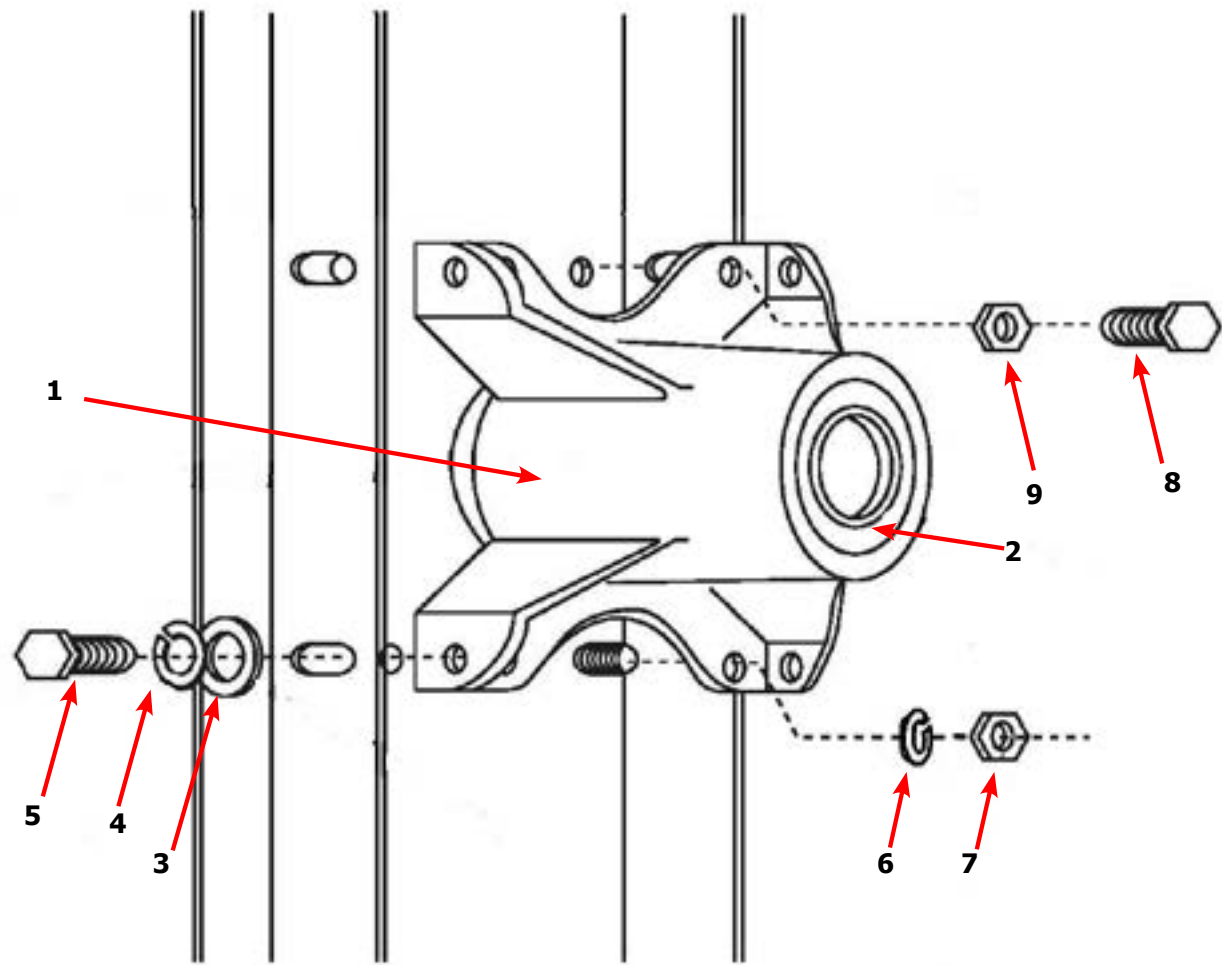

Key	Description	T-80	QTY
	Bearing Housing Complete Assy (Includes bearings & Spacer)	9803-189-001	
1	Housing, Bearing	9241-183-003	
*	Bearing, Ball, Front	9036-159-002	
2	Bearing, Ball, Rear	9036-159-001	
3	Washer, Flat 1/2	8641-581-026	
4	Lock Washer Spring, 1/2	8641-582-004	
5	Screw, 1/2-13x1	9545-017-004	
6	Lock Washer Spring, 1/2	8641-582-004	
7	Nut, 7/16-14	8640-416-001	
8	Screw, 7/16-14x1 1/2	9545-059-003	
9	Nut, 7/16-14	8641-416-001	

Dryer Tumbler Group 80Lb

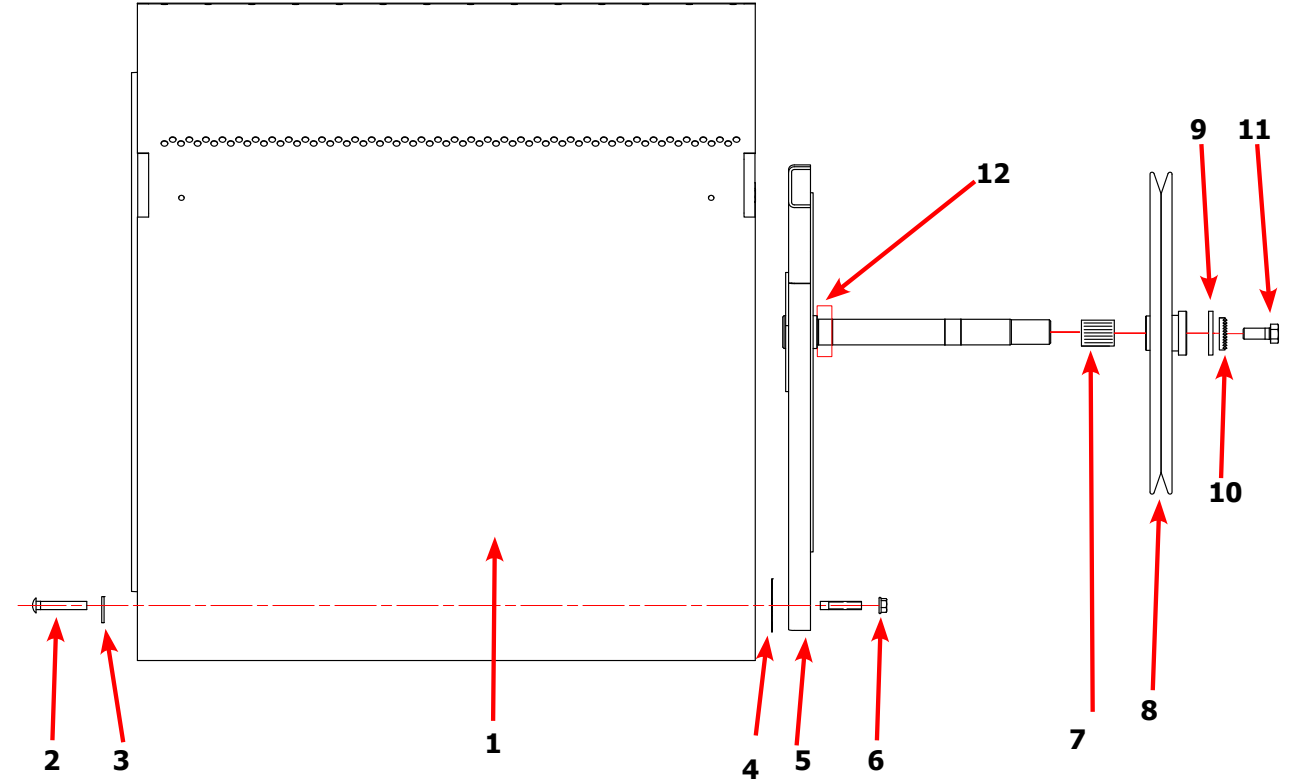

Key	Description	T80	QTY
*	Tumbler Assy Complete W/Spider (GALV)	9848-139-001	1
1	Tumbler Assy (Galvanized)	9849-138-001	1
1	Tumbler Assy Complete W/Spider (SS & Galv front)	9848-139-002	1
1	Tumbler Assy (Stainless Galvanized front)	9849-138-002	1
2	Rod, Tumbler	9497-226-001	4
3	Washer, Special	8641-590-001	4
4	Shim	9552-013-003	AR
5	Spider Assy w/Front Bearing	9873-008-001	1
6	Nut, Wiz Lock	8640-417-005	4
7	Tolerance Ring	9487-234-001	1
8	Pulley, Driven	9908-043-002	1
9	Washer -Flat	8641-581-026	1
10	LockWasher - IntTooth, 1"	8641-582-016	1
11	Screw, 1/2-13x1 1/4	9545-017-009	1
12	Bearing, Front	9036-159-002	1

Dryer Burner Housing Group 80Lb

Key	Description	Part Number	Qty
	Housing Assembly, Burner	9803-212-001	1
1	Panel-Burner Housing, Front	9454-863-001	1
2	Panel-Burner Housing, Side Right	9454-861-001	1
3	Panel-Burner Housing, Side Left	9454-862-001	1
4	Panel-Burner Housing, Back	9454-864-001	1
5	Baffle-Burner Housing, Center	9049-098-001	1
6	Panel-Burner Housing, Top	9454-849-001	1
7	Panel-Burner Housing, Top	9074-343-001	1
8	Baffle-Burner Housing, Extention	9049-100-001	1
9	Duct Adaptor, 6"x1.25" long	9109-120-002	1
10	Baffle-Burner Housing, Recirculation	9049-099-001	1
11	Side-Extention Baffle, Burner Housing	9551-049-001	2
12	Bracket-Support, Burner	9029-213-001	1
13	Burner, Main	9048-021-001	4
14	Screw, 10T-32x1/2	9545-008-008	4
15	Electrode-Ignition	9875-002-003	1
16	Cover-Burner, Intet	9074-344-001	1
17	Bracket-Support, Gas Valve	9029-234-001	1
18	Control Assy, Gas Valve, White Rodgers 36J	9857-193-001	1
19	Bracket-support, Gas Valve Left hand	9029-235-001	4
20	Valve-Gas Shutoff, (Optional)	9379-196-001	1
21	Manifold Assy	9381-014-001	1
22	Orifice-Natural, #29	9425-069-021	3
*	Orifice-LP, #46	9425-069-022	3
*	Kit, LP Conversion, White Rodgers	9732-102-023	1
23	Thermostat-HI-Limit	9576-203-002	1
24	Spacer-1/4x5/8 long	9538-166-009	2
25	Screw-8Bx1	9545-045-013	2
26	Screw, 10Bx1/4	9545-008-001	22
27	Screw, 10ABx3/8	9545-008-024	31
28	Bushing-Reducer, 3/4x1/2	8615-104-009	1

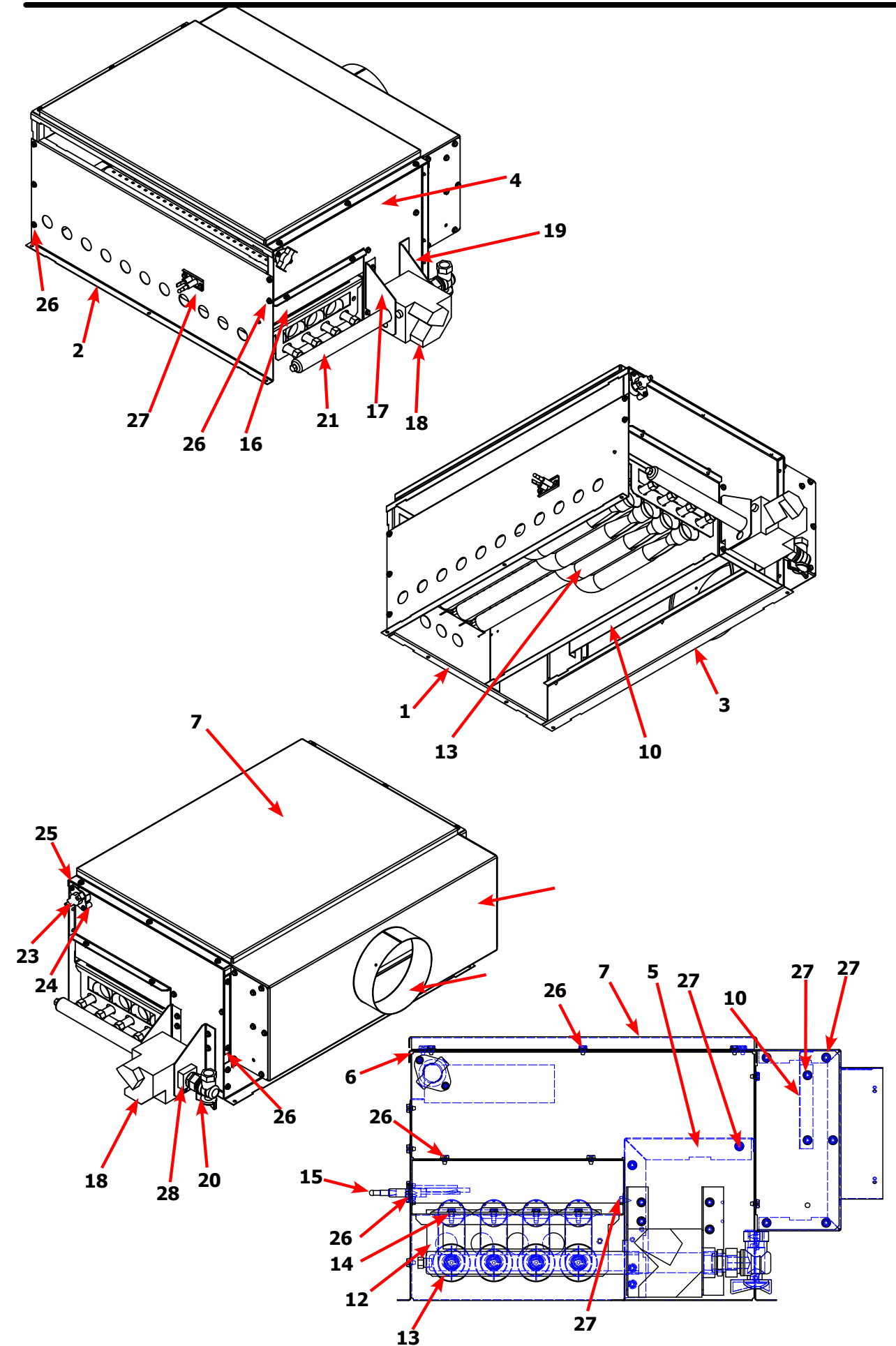

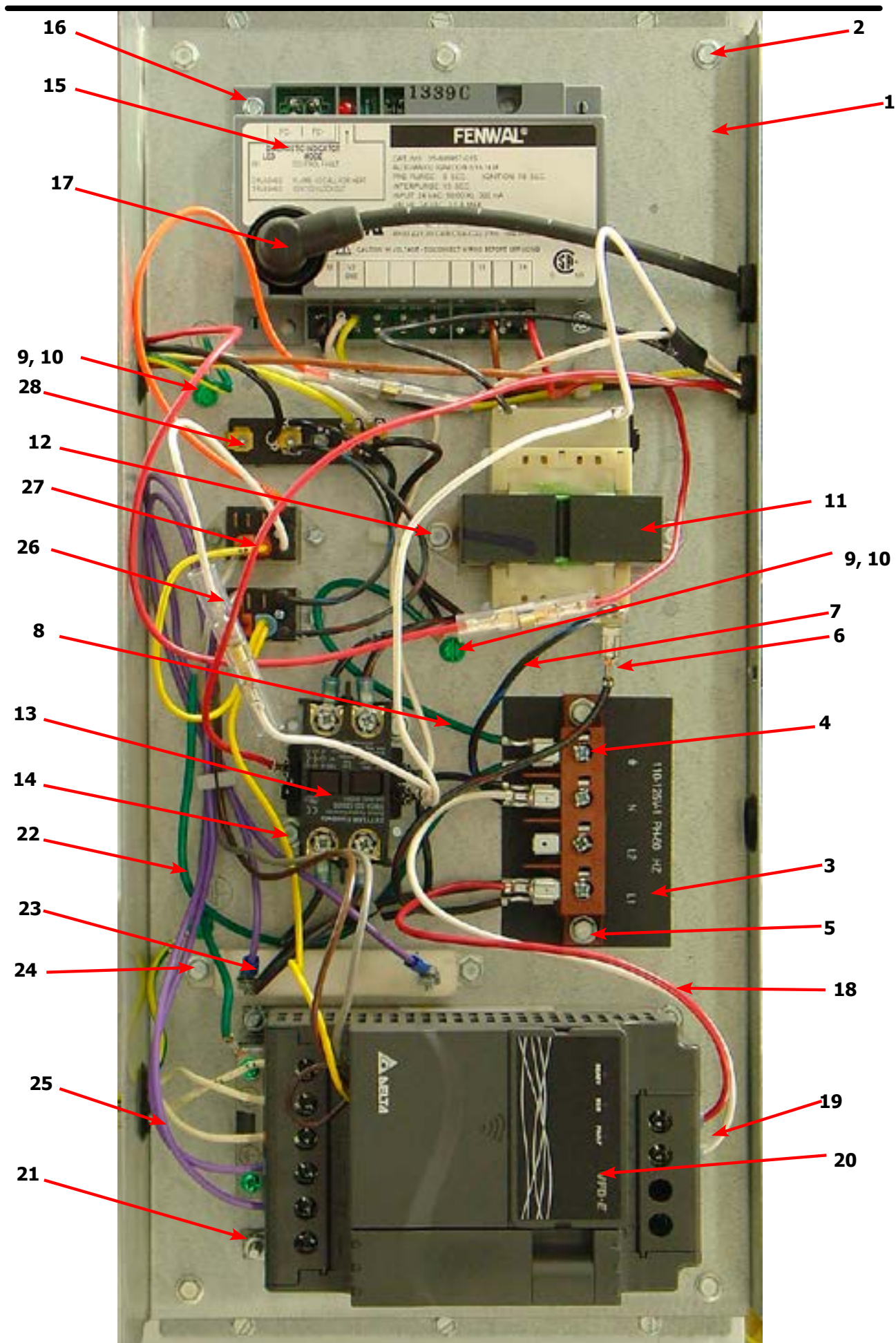

Dryer Rear View-Control Box

Key	Description	T80	QTY
1	Wrapper-Control Box	9636-203-001	1
2	Screw, 5/16-10AB-3/8	9545-008-001	6
*	Cover-Control Box	9074-353-001	1
*	Screw, 5/16-10AB-3/8	9545-008-024	1
3	Strip-Marker, Terminal	9558-029-005	1
4	Terminal Block Assy-Power, 4Pole	9897-035-001	1
5	Screw, 5/16-10AB-3/8	9545-008-024	2
6	Wire assy-Blk/Red, 6 1/2"	8220-001-230	1
7	Wire assy-Blk/Blu, 6 1/2"	8220-001-231	1
8	Wire Assy, GRN, 7"	8220-001-478	1
9	Screw- 10-32TTx1/2 GRN	9545-008-027	2
10	Lockwasher, External tooth	8641-582-006	2
11	Transformer, w/Circuit braker	8711-007-002	1
12	Screw, 5/16-10AB-3/8	9545-008-024	2
13	Relay-Motor, 30Amp, 24VAC	5192-299-002	1
14	Screw, 5/16-10AB-3/8	9545-008-024	2
*	Wire assy-Blk/Red, 9"	8220-146-001	2
*	Wire assy-Blk/Blu, 9"	8220-146-002	2
15	Control Assy, Ignition (Module)	9857-182-001	1
16	Screw-8Bx3/4"	9545-045-007	2
*	Harness, Ignition Module	9627-867-003	1
17	Wire Assy- High Voltage Lead	9631-403-009	1
18	Wire Assy-Red, 12"	8220-067-004	1
19	Wire Assy- White, 12"	8220-067-003	1
20	Drive-VD Inverter, 1HP, 120VAC	9375-026-002	1
21	Nut, #10-32UNF	8640-413-002	4
22	Wire Assy-Green, 18"	8220-092-006	1
*	Wire Assy-BRN, 19"	8220-078-019	1
*	Wire Assy-Yellow, 20"	8220-082-002	1
*	Wire Assy-Gray, 18"	8220-078-018	1
*	Wire Assy, Brown 3"	8220-057-035	1
23	Resistor-Dynamic Breaking, 200OHM	9483-004-002	1
24	Screw-5/16, 10ABx3/8	9545-008-024	2
25	Wire Assy, Violet 24"	8220-118-001	2
26	Relay, 120VAC	5192-285-001	1
27	Relay, 24VAC	5192-285-004	1
*	Wire Assy-BLK/BLU, 15"	8220-063-021	1
*	Wire Assy-BLK/RED, 12"	8220-063-010	1
28	Terminal Block	9897-039-001	1

Wiring Schematic for 60hz Dryer -10BD

CAUTION: LABEL ALL WIRES PRIOR TO DISCONNECTION WHEN SERVICING CONTROLS. WIRING ERRORS CAN CAUSE IMPROPER AND DANGEROUS OPERATION. VERIFY PROPER OPERATION AFTER SERVICING.

ATTENTION: AU MOMENT DEL'ENTRIEN DES COMMANDES, ÉTIQUETEZ TOUS LES FILS AVANT DE LES DÉBRANCHER. DES ERREURS DE CÂBLAGE PEUVENT ENTRAÎNER UN FONCTIONNEMENT INADÉQUAT ET DANGEREUX. S'ASSURER QUE L'APPAREIL FONCTIONNE ADEQUATEMENT UNE FOIS L'ENTRIEN TERMINÉ.

- NOTES:
1. DOOR SWITCHES—N.O., CLOSED WHEN DOORS ARE CLOSED.
 2. DRYER STARTS WHEN THE DOORS ARE CLOSED, A CYCLE IS SELECTED, AND THE START BUTTON IS PUSHED. THERE IS AN AUTOMATIC COOL DOWN CYCLE AT THE END OF THE CYCLE.
 3. CENTRIFUGAL SWITCH—N.O. CLOSSES WHEN BLOWER MOTOR IS UP TO SPEED.
 4. REFER TO OWNER'S MANUAL FOR DESCRIPTION OF OPERATION AND REQUIREMENTS FOR HEATING CIRCUIT.
 5. WITH A DC MICROAMMETER, FLAME CURRENT CAN BE MEASURED AT TEST POINTS. READING SHOULD BE 0.7UA DC OR HIGHER.

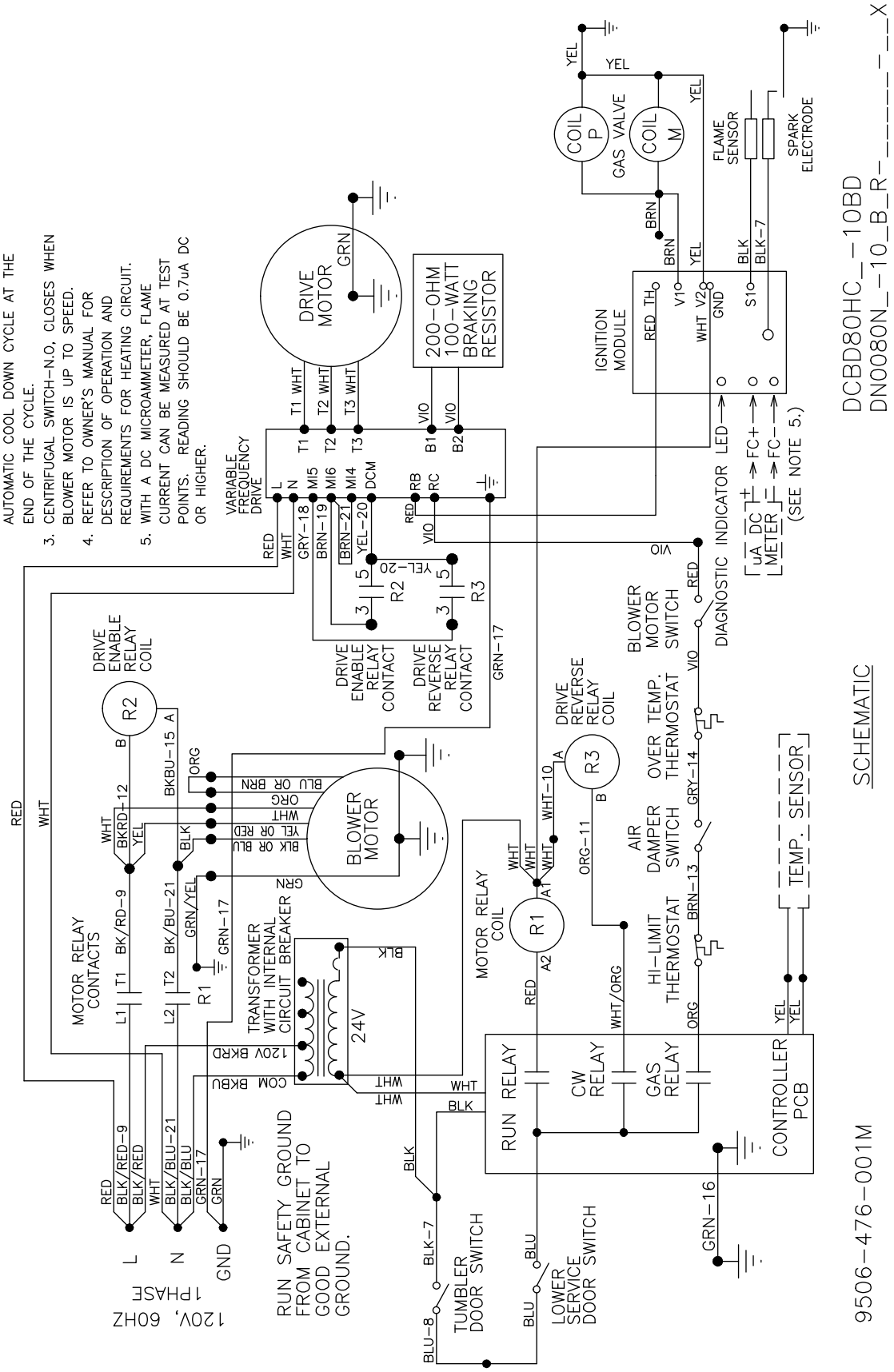

9506-476-001M

SCHEMATIC

DCBD80HC_10BD
DN0080N_10_B_R_---X

Wiring Diagram for 60hz Dryer -10BD

CAUTION: LABEL ALL WIRES PRIOR TO DISCONNECTION WHEN SERVICING CONTROLS. WIRING ERRORS CAN CAUSE IMPROPER AND DANGEROUS OPERATION. VERIFY PROPER OPERATION AFTER SERVICING.

ATTENTION: AU MOMENT DEL'ENTRIEN DES COMMANDES, ÉTIQUETEZ TOUS LES FILS AVANT DE LES DÉBRANCHER. DES ERREURS DE CÂBLAGE PEUVENT ENTRAÎNER UN FONCTIONNEMENT INADÉQUAT ET DANGEREUX. S'ASSURER QUE L'APPAREIL FONCTIONNE ADEQUATEMENT UNE FOIS L'ENTRIEN TERMINÉ.

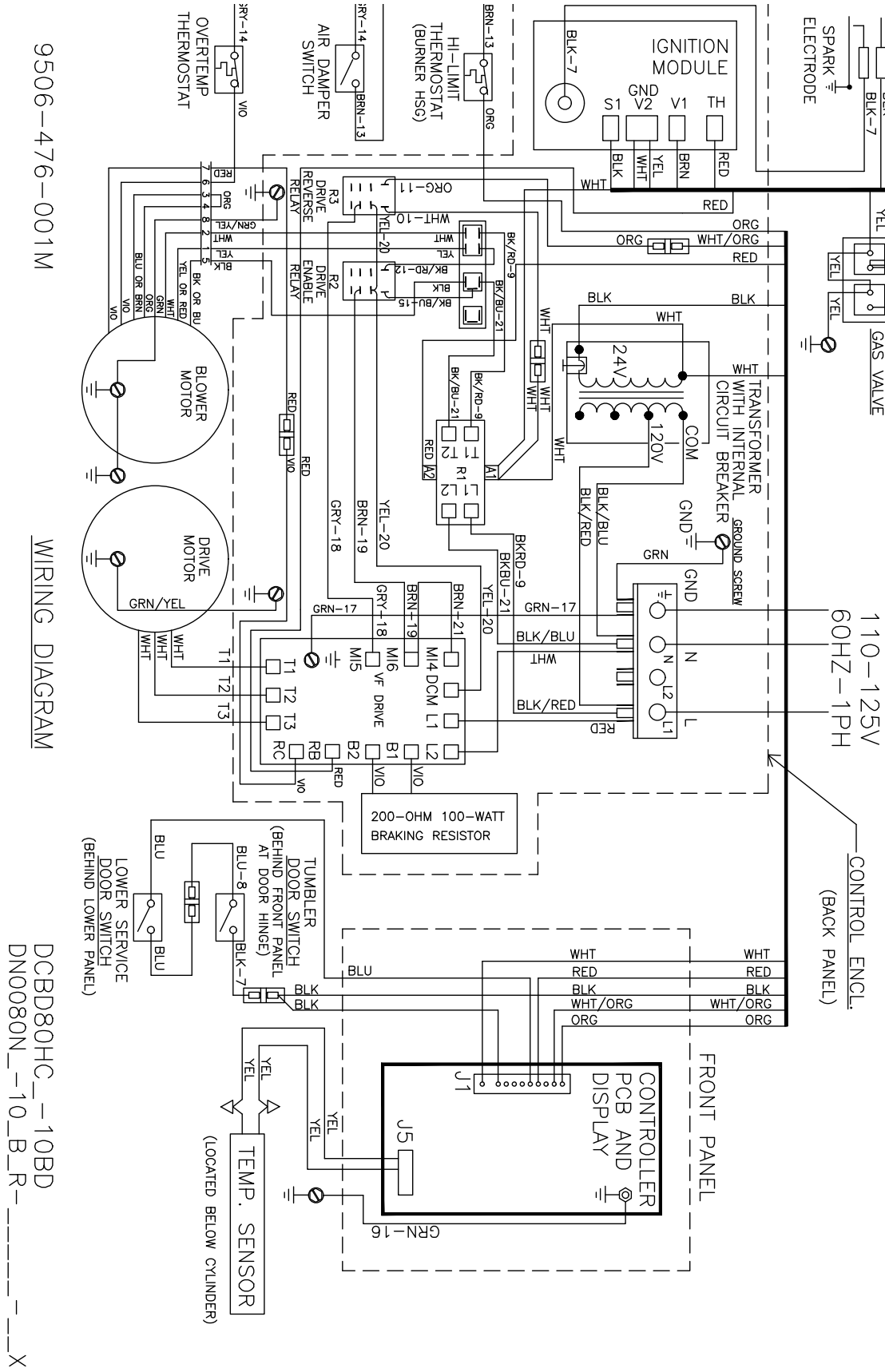

DCBD80HC_10BD
DN0080N_10_B_R_---X

WIRING DIAGRAM

9506-476-001M

Key	Description	T80	QTY
*	Wrapper-Control Box	9636-203-001	1
*	Screw, 5/16-10AB-3/8	9545-008-024	9
*	Cover-Control Box	9074-353-001	1
*	Screw, 5/16-10AB-3/8	9545-008-024	1
*	Strip-Marker, Terminal	9558-029-004	1
*	Terminal Block Assy-Power, 4Pole	9897-035-001	1
*	Screw, 5/16-10AB-3/8	9545-008-024	2
*	Wire assy-Blk/Red, 6 1/2"	8220-001-230	1
*	Wire assy-Blk/Blu, 6 1/2"	8220-001-231	1
*	Wire Assy, GRN/Yel, 7"	8220-137-002	1
*	Screw- 10-32TTx1/2 GRN	9545-008-027	2
*	Lockwasher, External tooth	8641-582-006	2
*	Transformer, w/Circuit braker	8711-007-002	1
*	Screw, 5/16-10AB-3/8	9545-008-024	2
*	Relay-Motor, 30Amp, 24VAC	5192-299-002	1
*	Screw, 5/16-10AB-3/8	9545-008-024	2
*	Wire assy-Blk/Red, 9"	8220-146-001	2
*	Wire assy-Blk/Blu, 9"	8220-146-002	2
*	Control Assy, Ignition (Module)	9857-182-001	1
*	Screw-8x3/4"	9545-045-007	2
*	Harness, Ignition Module	9627-867-003	1
*	Wire Assy- High Voltage Lead	9631-403-009	1
*	Wire Assy-Blue, 17"	8220-065-018	1
*	Wire Assy- Black, 11"	8220-065-032	1
*	Drive-VD Inverter, 1HP, 120VAC	9375-027-002	1
*	Nut, #10-32UNF	8640-413-002	4
*	Wire Assy-Green, 18"	8220-092-006	1
*	Wire Assy-BRN, 19"	8220-078-019	1
*	Wire Assy-Yellow, 20"	8220-082-002	1
*	Wire Assy-Gray, 18"	8220-078-018	1
*	Wire Assy, Brown 3"	8220-057-035	1
*	Relay, 230VAC	5192-285-002	1
*	Relay, 24VAC	5192-285-004	1
*	Wire Assy-BLK/BLU, 15"	8220-063-021	1
*	Wire Assy-BLK/RED, 12"	8220-063-010	1

Control Box Informative for 50hz Dryer -39BD

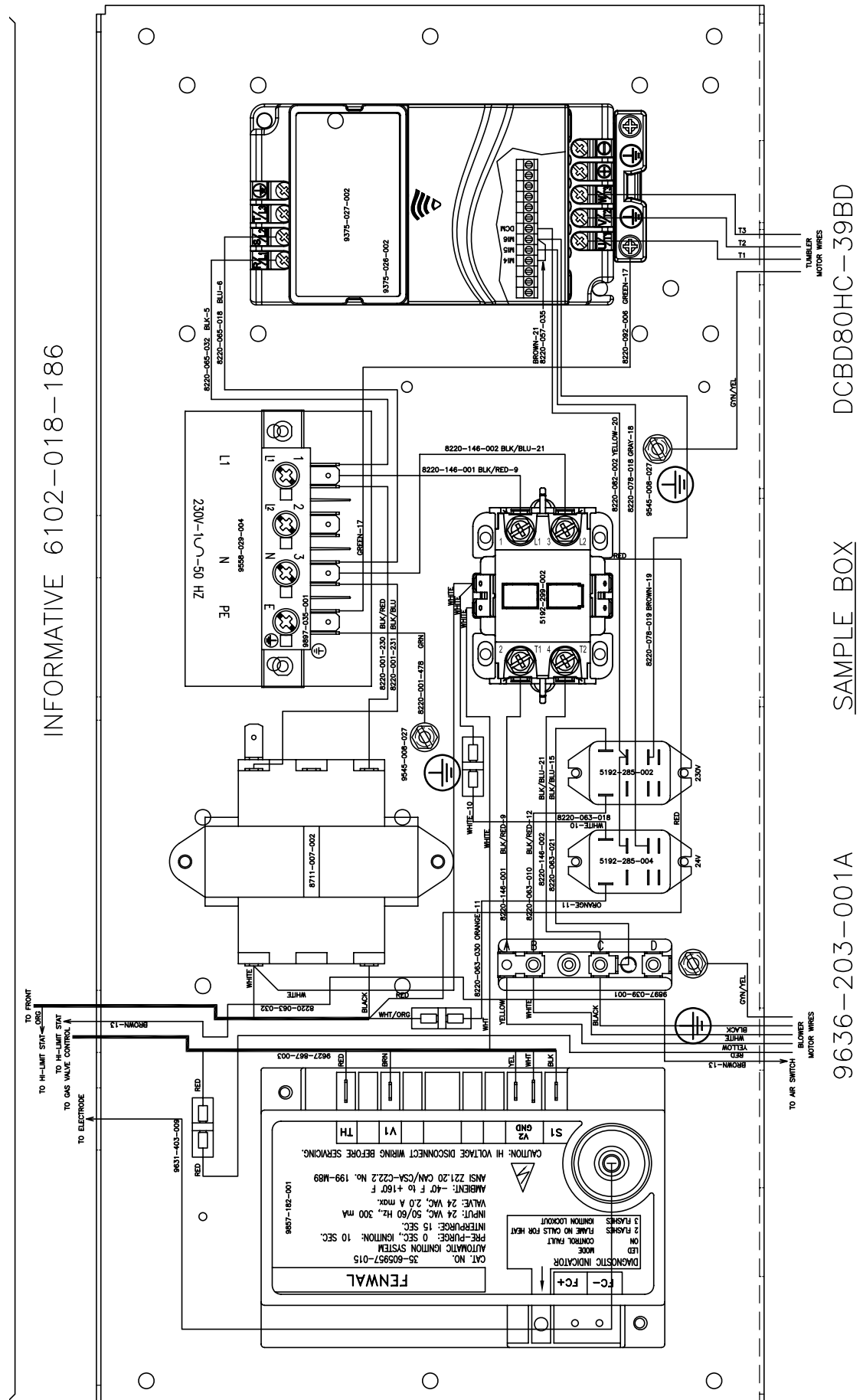

DCBD80HC--39BD

SAMPLE BOX

9636-203-001A

Section 7:

Maintenance

Schedule

Preventative Maintenance

Daily

- Step 1:** Clean the lint screen free of lint and other debris. Use a soft brush and Hot water if necessary.
- Step 2:** Check the lint screen for tears. Replace if necessary.
- Step 3:** Clean lint from the lint screen compartment.
- Step 4:** Inspect felt seal on lint screen assembly, replace if needed.

Monthly

- Step 1:** Remove lint accumulation from the end bells of the motor.
- Step 2:** Remove lint accumulation from front control area.
- Step 3:** Remove lint and dirt accumulation from the top of the dryer and all areas above, below, and around the burners and burner housing. Failure to keep this portion of the dryer clean can lead to a build-up of lint creating a fire hazard.
- Step 4:** Remove and clean coin acceptors. (Vended Models Only)

Quarterly

- Step 1:** Check the belts for looseness, wear, or fraying.
- Step 2:** Inspect the gasket of the door glass for excessive wear.
- Step 3:** Check tightness of all fasteners holding parts to support channel.
- Step 4:** Check tightness of all set screws.
- Step 5:** Remove the air flow switch assembly and check the tumbler thru-bolts for tightness.
- Step 6:** Apply a few drops of oil to pivot pins and the tension arms where in contact with each other.

Semi-Annually

- Step 1:** Remove and clean the main burners.
- Step 2:** Remove all orifices and examine for dirt and hole obstruction.
- Step 3:** Remove all lint accumulation. Remove the front panel and the lint screen housing and remove lint accumulation.

Annually

- Step 1:** Check the intermediate pulley bearings for wear.
- Step 2:** Check and remove any lint accumulation from the exhaust system including recirculation chambers if applicable.
- Step 3:** Grease the bearings and the shaft of the intermediate pulley. Use an Alemite grease gun and Molykote BR2-S grease. (Where applicable)