







DEXTER[®]
LAUNDRY

**USE THE BLUE TABS LOCATED ON THE
RIGHT AND LEFT SIDES OF THE FOLLOWING
DOCUMENT TO ADVANCE TO EACH SECTION.**



DC50X2 Reversing Vended Models /
24VAC Control
50 Pound Stacked Commercial Dryer

Equipment Safety Warnings Symbols and Terminology Used in this Equipment

⚠ DANGER	Indicates an imminently hazardous situation, which if not avoided, will result in death or serious injury.
⚠ WARNING	Indicates a potentially hazardous situation, which if not avoided could result in death or serious injury.
⚠ CAUTION	Indicates a potentially hazardous situation which, if not avoided, may result in minor or moderate injury. It may also be used to alert against unsafe practices. Minor burns, pinch points that result in bruises and minor chemical irritation.
NOTICE	Indicates information or a company policy that relates directly or indirectly to the safety of personnel or protection of property.
	This is the user caution symbol. It indicates a condition where damage to the equipment resulting in injury to the operator could occur if operational procedures are not followed. TO REDUCE THE RISK OF DAMAGE OR INJURY, refer to accompanying documents; follow all steps or procedures as instructed.
	This is the electrical hazard symbol. It indicates that there are DANGEROUS HIGH VOLTAGES PRESENT inside the enclosure of this product. TO REDUCE THE RISK OF FIRE OR ELECTRIC SHOCK, do not attempt to open the enclosure or gain access to areas where you are not instructed to do so. REFER SERVICING TO QUALIFIED SERVICE PERSONEL ONLY
	Caution! There are sharp edges on various sheet metal parts internal to the enclosure. Use safety consciousness when placing or moving your hands while working in the interior of this equipment.
	Caution! To reduce the risk of damage to the Water Inlet Valve, do not supply inlet water with a temperature that exceeds 70° C. Caution! To reduce the risk of fire or explosion, do not operate this equipment in any hazardous classified (ATEX) environment.

Equipment Safety Warnings

Symbols and Terminology Used in this Equipment



Warning! Do not operate equipment if door glass is damaged in any way.



Warning! Keep clear of rotating parts.



Prohibited! Do not enter this equipment or space.



Prohibited! Do not step or stand on this equipment.



Prohibited! Do not operate without all guards and covers in place.









Prohibited! Do not operate without all guards and covers in place.



Prohibited! Do not wash or Dry clothing impregnated with flammable liquids (petrochemical).



Prohibited! Do not allow children to play in or around equipment.

	Indicates an imminently hazardous situation, which if not avoided, <u>will result</u> in death or serious injury.
	Indicates a potentially hazardous situation, which if not avoided <u>could result</u> in death or serious injury.
	Indicates a potentially hazardous situation which, if not avoided, <u>may result</u> in minor or moderate injury. It may also be used to alert against unsafe practices. Minor burns, pinch points that result in bruises and minor chemical irritation.
	Indicates information or a company policy that relates directly or indirectly to the safety of personnel or protection of property.
	This is the user caution symbol. It indicates a condition where damage to the equipment resulting in injury to the operator could occur if operational procedures are not followed. TO REDUCE THE RISK OF DAMAGE OR INJURY, refer to accompanying documents; follow all steps or procedures as instructed.
	This is the electrical hazard symbol. It indicates that there are DANGEROUS HIGH VOLTAGES PRESENT inside the enclosure of this product. TO REDUCE THE RISK OF FIRE OR ELECTRIC SHOCK, do not attempt to open the enclosure or gain access to areas where you are not instructed to do so. REFER SERVICING TO QUALIFIED SERVICE PERSONEL ONLY
	Caution! To reduce the risk of fire or explosion, do not operate this equipment in any hazardous classified (ATEX) environment.



WARNING

	<ul style="list-style-type: none"> • All Dryers must be installed in accordance to all applicable electrical, plumbing and all other local codes. • These installation and operation instructions are for use by qualified personnel only. To avoid injury and electrical shock, do not perform any servicing other than that contained in the installation and operation instructions, unless qualified.
	Do not install Equipment in an explosive atmosphere.
	<ul style="list-style-type: none"> • Care must be stressed with all foundation work to ensure a stable unit installation, eliminating possibilities of excessive vibration. • Foundation must be level within 13 mm to ensure proper washer operation.
	Do not operate washer or Dryer if door glass is damaged in any way.
	Do not wash or Dry clothing impregnated with flammable liquids (petrochemical).



WARNING





 	Children should be supervised to ensure they do not operate or play in or around equipment.
	Keep all panels in place to protect against electrical shock and injury and add rigidity to washer.

This appliance is not intended for use by persons (including children) with reduced physical, sensory or mental capabilities, or lack of experience and knowledge, unless they have been given supervision or instruction concerning use of the appliance by a person responsible for their safety.

A washer should not be allowed to operate if any of the following occur:

- Excessive high water level.
- Machine is not connected to a properly earthed circuit.
- Door does not remain securely locked during the entire cycle.
- Vibration or shaking from an inadequate mounting or foundation

	Warning! Do not operate equipment if door glass is damaged in any way.
	Warning! Keep clear of rotating parts.
	Prohibited! Do not enter this equipment or space.
	Prohibited! Do not step or stand on this equipment.
	Prohibited! Do not operate without all guards and covers in place.
	Prohibited! Do not operate without all guards and covers in place.
	Prohibited! Do not wash or Dry clothing impregnated with flammable liquids (petrochemical).
	Prohibited! Do not allow children to play in or around equipment.

	Prohibited! Do not attempt to open, touch, or proceed before referring to the manual or unless qualified.
	Mandatory! Read all supporting documentation before operating or maintaining equipment.
	Mandatory! Disconnect power before servicing equipment.
	Mandatory! Lock out and tag out before servicing this equipment.
	Mandatory! Children should be supervised to ensure they do not operate equipment.

Notes

Dexter Safety Guidelines

! WARNING

For your safety, the information in this manual must be followed to minimize the risk of fire or explosion or to prevent property damage, personal injury or loss of life.

IF YOU SMELL GAS:

- Do not try to light any appliance.
- Do not touch any electrical switch: do not use any telephone in your building.
- Clear the room, building or area of all occupants.
- Immediately call your gas supplier from a neighbor’s telephone.
- Follow the gas supplier’s instructions.
- If you cannot reach your gas supplier, call the fire department. Installation and service must be performed by a qualified installer, service agency or the gas supplier.

Dry only fabrics washed in water to avoid the risk of fire, including spontaneous combustions, do not dry:

- Items containing foam rubber, or any similarly textured rubber-like materials.
- Any items on which you have used a cleaning solvent or which contain flammable liquids or solids, such as naphtha, gasoline, or other oils or waxes.

To activate your warranty, be sure to return your red warranty form to the factory. Please have serial number and model ready when calling for assistance.

Table of Contents

Section 1:

Specifications..... 14 & 15

Section 2:

Installation and Operation

Installation Clearances..... 18
 Make Up Air 19
 Electrical Requirements 19
 Gas Requirements 19
 Burner Set Up 19
 Exhaust Installation20 & 21
 Description of Control 22
 Operating Instructions 22
 Characteristics of a Running Dryer..... 22

Section 3:

Programming

DexterLive 26
 DexterLive Create Account..... 27-29
 DexterLive Setup & Programming.....30-33
 Programming with USB33-35
 Manual Program Mode..... 36 & 37
 Programming options 38-49

Section 4:

Wiring Schematics

Dryer Idle- No Coins Added..... 52
 Coins Added-Motor Starting and Running 52
 Heat Circuit..... 52
 Over Temperature Thermostat 53
 Cool Down..... 53

End of Cycle 53
 Wiring Diagram for DDAD Dryer 54
 Wiring Schematic for DDAD Dryer 55

Section 5:
Service Procedures

Clothes Door Removal 58
 Clothes Door Latch Adjustment 58
 Door Switch Removal and Installation 58
 Installation of Clothes Door Window and Gasket . 58
 High Limit Thermostat Locations and Functions .. 58
 Pressure Regulator Adjustment 59
 Coin Acceptor Removal 59
 Coin Switch Adjustment 59
 Heat Sensor 59
 Electronic Control Diagnostic Lights 59
 Electronic Control Test Cycle 60
 Electronic Control Removal 60
 Membrane Switch Replacement 60
 Temperature Sensor Testing 60
 Temperature Testing 60
 Temperature Sensor Removal..... 60
 Upper Front Panel Removal..... 61
 Lower Front Panel Removal..... 61
 Final Drive Belt Replacement..... 61
 Motor Drive Belt Replacement 61
 Tumbler Pulley Removal and Installation 61
 Intermediate Pulley and Tension Arm Removal.. 61
 Tension Arm Support Assembly Adjustment .. 61
 Motor and Blower Assembly Removal
 and Installation 61
 Air Flow Switch Operation and Adjustment.... 62
 Ignition Transformer Fuse 62
 Ignition Control Transformer 62
 Electronic Ignition Module..... 62
 Spark Electrode Assembly Function 63
 Ignition System Function and Sequence..... 63
 Ignition System Checkout 63
 Spark Electrode Assembly Removal 63
 Gas Valve & Manifold Removal 63
 Main Burner Orifice Removal 64
 Main Burner Removal..... 64
 Recirculation Chamber Inspection..... 64
 Cylinder Removal 64
 Adjustment of Cylinder Assembly
 with Front Panel Removed 64
 Tumbler Through Bolt Access Cover..... 64
 Bearing Housing Removal 64

Section 6:
Troubleshooting

Quick Guide Troubleshooting 66
 Electronic Control Diagnostic Lights 67
 Trouble Shooting Fault Codes..... 68
 Troubleshooting Tips 68-71

Section 7:
Parts Data

Cabinet Group..... 74-77
 Electronic Control Group Front 78 & 79
 Door Switch Group 80
 Bearing Housing Group..... 81
 Burner Housing Group 82 & 83
 Rear View 84 & 85
 Rear Panel & Cover Group 86
 Tumbler Assembly Group 87
 Control Assembly Group 88 & 89
 Coin Handling Group..... 90

Section 8:
Voltage Conversion..... 96 & 97

Section 9:
50Hz Parts

Rear View 102-103
 Electrical..... 104
 Burner 104
 Air Flow Switch Assy..... 105
 Schematic & Diagram 106-107

Section 10:
Maintenance

Regular Required Maintenance 110

Notes

Blank lined area for taking notes.

Section 1:

Specifications

SPECIFICATIONS

50 lb. Commercial Stack Dryer: T-50x2 Reversing Tumbler DC50X2NC-11EC2R (60 Hz), DC50X2NC-49AC2R (50 Hz)

Cabinet Height (Assumes minimum leveling leg adjustment)	79 1/4"	2012 mm.
Cabinet Width	34 1/2"	876 mm.
Overall Depth	56 3/4"	1441 mm.
Floor to Bottom of Door- Bottom Dryer	7"	178 mm.
Floor to Bottom of Door- Top Dryer	46"	1168 mm.
Door Opening	25 5/8"	651 mm.
Dry Wt. Capacity	50 x 2 lbs.	22.7 x 2 kg.
Cylinder Diameter	32 1/2"	826 mm.
Cylinder Depth	33"	838 mm.
Cylinder Volume	15.84 cu. ft.	448 liters
Lint Screen Area	544 sq. in.	3510 sq. cm.
Gas Input (per dryer- 60 hz)	108,000 Btu/hr	31.7 kW
Gas Input (per dryer- 50 hz)	96,500 Btu/hr	28.3 kW
Gas Supply Connection	1/2"	12.7 mm.
Natural Gas Supply (Water Column)	5-8"	127 mm. - 203 mm.
Natural Burner Manifold (60 hz Water Column)	3.5"	88.9 mm
(50 hz Water Column)	3.5"	88.9 mm
L.P. Supply (Water Column)	11.5 -14"	292 mm. - 356 mm.
L.P. Burner Manifold Pressure (60 hz Water Column)	11"	279 mm
(50 hz Water Column)	10"	254 mm
Exhaust Size	8"	203 mm.
Make-up Air	1.5 sq. ft.	1394 sq. cm.
	Example: 1.5 sq. ft = 1 ft. long X 1.5 ft. wide	
Motor Size	3/4 H.P.	.560 kW
Airflow (60 Hz)	650 CFM	18.4 m ³ /min
Airflow (50 hz)	510 CFM	14.4 m ³ /min

Electrical Specifications – 208-240/60/1

Voltage/Hz/Phase	208-240V/60Hz/1Phase
Running Amps	15
Circuit Protection Amps	20
Wire Size	12 gauge
Electrical Service	2 wire + ground

Electrical Specifications – 240/50/1

Voltage/Hz/Phase	240V/50Hz/1Phase
Running Amps	15
Circuit Protection Amps	20
Wire Size	3.5 mm ²
Electrical Service	2 wire + ground

Shipping Weight	917 lbs.	416 kg.
Net Weight	857 lbs.	389 kg.
Clearance Behind Machines (min.)	18"	457 mm.

Section 2: Installation & Operation

DRYER INSTALLATION

1. CODE CONFORMITY: All commercial dryer installations must conform with local codes, or in the absence of local codes, with the latest edition of the National Fuel Gas Code ANSI Z223.1. Canadian installations must comply with the current Standard CAN/CGA-B149 (.1 or .2) Installation Code for Gas Burning Appliances or Equipment, and local codes if applicable. Australian installations must meet installation requirements and pipe sizing requirements of AS/NZA 5601. The appliance, when installed, must be electrically grounded in accordance with the latest edition of the National Electric Code, ANSI/NFPA70, or, when installed in Canada, with Standard CSA C22.1 Canadian Electrical Code Part 1.

2. INSTALLATION CLEARANCES: This unit may be installed at the following alcove clearances:

- I. Left Side 0"
- II. Right Side 0"
- III. Back 18" (457 mm) (Certified for 6" (150 mm) clearance; however, 18" (457 mm) clearance is necessary behind the motors to allow servicing and maintenance.)
- IV. Front 48" (1220 mm) (to allow use of dryer)
- V. Top Refer to figure labeled "Vertical Clearance Dimensions".
AB. Certification allows 0" clearance at the top 4" (100 mm) back from the front.
However, a 1/4" (6 mm) clearance should be allowed in case the dryer needs moving.
C. A 10" (250 mm) clearance is required from top at all other points.
- VI. Floor This unit may be installed upon a combustible floor.

Do not obstruct the flow of combustion and ventilation air.

Maintain minimum of 1" (25 mm) clearance between duct and combustible material.

Refer to the label attached to the belt guard on the rear of the dryer for other installation information and start-up instructions.

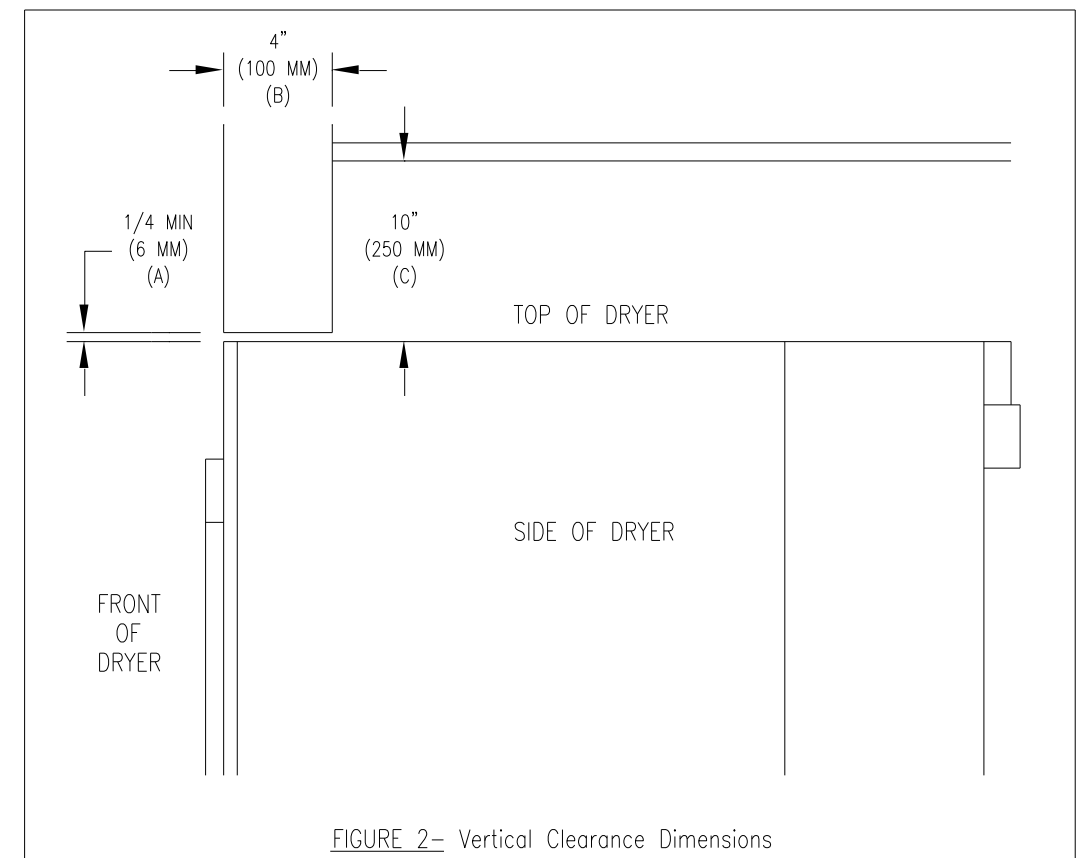

3. MAKE-UP AIR: Adequate make-up air must be supplied to replace air exhausted by dryers on all types of installations. Refer to specifications for the minimum amount of make-up air opening to outside for each dryer. This is a net requirement of effective area. Screens, grills or louvers, which will restrict the flow of air, must be considered. Consult the supplier to determine the free area equivalent for the grill being used. The source of make-up air should be located sufficiently away from the dryers to allow an even airflow to the air intakes of all dryers. Multiple openings should be provided.

The sources of all make-up air and room ventilation air movement to all dryers must be located away from any dry cleaners. This is necessary so that solvent vapors will not be drawn into the dryer inlet ducts. Dry cleaner solvent vapors will decompose in contact with open flame such as the gas flame present in clothes dryers. The decomposition products are highly corrosive and will cause damage to the dryer(s) ducts and clothes loads.

4. ELECTRICAL REQUIREMENTS. The electrical power requirements necessary to operate the unit satisfactorily are listed on the serial plate located on the back panel of each dryer and in the specifications section of this manual. The electrical connection should be made to the terminal board, on the rear of the unit. It is absolutely necessary that the dryer be grounded to a known ground. Individual circuit breakers for each stacked dryer are required. Dryer -11 models are set to 208-240V (no neutral required) as required.

5. GAS REQUIREMENTS.

The complete gas requirements necessary to operate the dryer satisfactorily are listed on the serial plate located on the back panel of the dryer and in the specifications section of this manual. The inlet gas connection to the unit is 1/2-inch pipe thread. However, the size of the piping to supply the dryer should be determined by reference to the National Fuel Gas Code ANSI Z223.1A and consultation with the local gas supplier. An individual gas shutoff valve is recommended for each dryer and may be required by local code (not supplied). A joint compound resistant to the action of liquefied petroleum gases should be employed in making pipe connections. A 1/8-inch NPT plugged tapping, accessible for test gage connection, must be installed immediately upstream of the gas supply connection to the dryer. A drip tee is provided in the unit gas piping to catch dirt and other foreign articles.

All pipe connections should be checked for leakage with soap solution. Never check with an open flame. For altitudes above 2,000 feet (610m), it is necessary to derate the BTU input. Contact your local distributor for instructions. L.P. gas conversion kits are available for this dryer. Contact your local distributor.

CAUTION: The dryer must be disconnected from the gas supply piping system during any presuretesting of that system. Do not expose the dryer's gas control valve to testing pressure.

Burner Set-Up

All gas burner manifolds should be checked for proper gas pressure while burning. Stack dryer burners should be set at 3.5 W.C. while burner operating.

6. EXHAUST INSTALLATION. (Refer to Figure 3) Exhausting of the dryer(s) should be planned and constructed so that no air restrictions occur. Any restriction due to pipe size or type of installation can cause slow drying time, excessive heat, and lint in the room.

From an operational standpoint, incorrect or inadequate exhausting can cause a cycling of the high limit thermostat, which shuts off the main burners and results in inefficient drying.

The exhaust duct connection near the top of the dryer will accept an 8" (200 mm) round duct. Individual exhausting of the dryers is recommended. All heat, moisture, and lint should be exhausted outside by attaching a pipe of the proper diameter to the dryer adapter collars and extending it out through an outside wall. This pipe must be very smooth on the inside, as rough surfaces tend to collect lint, which will eventually clog the duct and prevent the dryer from exhausting properly. All elbows must be smooth on the inside. All joints must be made so the exhaust end of one pipe is inside the next one downstream. The addition of an exhaust pipe tends to reduce the amount of air the blower can exhaust. This does not affect the dryer operation if held within practical limits. For the most efficient operation, it is recommended that no more than 14 ft. (4.25 m) of straight 8 in. diameter pipe with two right angle elbows be used for each cylinder.

Maintain a minimum of 1" (25mm) clearance between duct and combustible material.

If the exhaust pipe passes through a wall, a metal sleeve of slightly larger diameter should be set in the wall and the exhaust pipe passed through this sleeve. This practice is required by some local codes and is recommended in all cases to protect the wall.

This type of installation should have a means provided to prevent rain and high winds from entering the exhaust when the dryer is not in use. A hood with a hinged damper can be used for this purpose. Another method would be to point the outlet end of the pipe downward to prevent entrance of wind and rain. In either case, the outlet should be kept clear, by at least 24 in. (610 mm) of any objects, which would cause air restriction.

Never install a protective screen over the exhaust outlet.

When exhausting a dryer straight up through a roof, the overall length of the duct has the same limits as exhausting through a wall. A rain cap must be placed on top of the exhaust and must be of such a type as to be free from clogging. The type using a cone shaped "roof" over the pipe is suitable for this application.

Exhausting the dryer into a chimney or under a building is not permitted. In either case there is a danger of lint buildup, which can be highly combustible.

Installation of several dryers, where a main discharge duct is necessary, will need the following considerations for installation (see Figure 3). Individual 8" (200 mm) exhaust ducts from each dryer should enter main discharge duct at a 45-degree angle in the direction of discharge airflow.

NOTE: Never install the individual ducts at a right angle into the main discharge duct. The individual ducts from the dryers can enter at the sides or bottom of the main discharge duct. Figure 3 indicates the various round main duct diameters to use with the individual dryer ducts. The main duct can be rectangular or round, provided adequate airflow is maintained. The total exhausting (main discharge duct plus duct outlet from the dryer) should not exceed the equivalent of 14 ft. (4.25 m) and two elbows. The diameter of the main discharge duct at the last dryer must be maintained to exhaust end.

NOTE: STATIC BACK PRESSURE should be a maximum of 0.3 in. w.c (7.6 mm w.c) at the rear exhaust outlet of the dryer. If multiple dryers are connected to the common duct, ensure the back draft damper is installed properly.

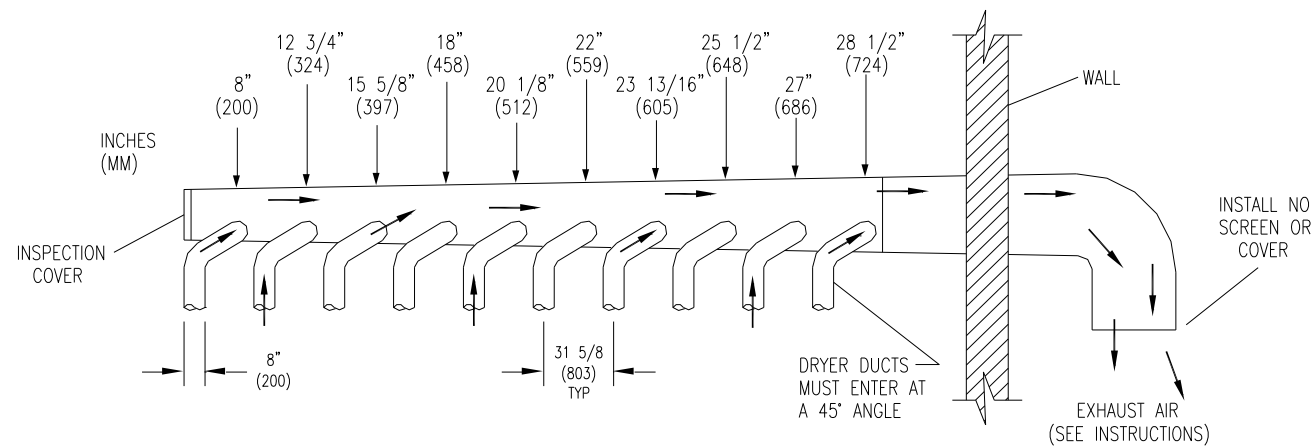

NOTE: A small diameter duct will restrict airflow; a large diameter duct will reduce air velocity - both contributing to lint build up. An inspection door should be provided for periodic clean out of the main duct.

7. DRYER IGNITION (SOLID STATE IGNITION): The solid-state ignition system lights the main burner gas by spark. The gas is ignited and burns only when the gas-relay (in the electronic controller) calls for heat. The procedure for first-time starting of a dryer is as follows.

- I. First review and comply with the "Warnings About Use and Operation" found on the inside front cover of this manual. Be sure electrical power is connected correctly. The dryer must be properly grounded.
- II. Make sure all gas supply lines are purged of air. Close the main gas shut-off valve and wait for five minutes before turning it back on.
- III. Turn on the main electrical power switch. The dryer may be started by following the "Operating Instructions" found later in this manual.
- IV. Natural gas and LPG fired dryers operate in the same manner. When the gas valve relay contacts are closed (indicating a demand for heat), the solid-state ignition control will automatically supply energy to the redundant gas valve. Sparking will continue until a flame is detected by the sensing probe, but not longer than ten seconds. If the gas fails to ignite in 10 seconds, the gas valve closes and the gas system pauses to allow gas to purge from the inside of the dryer. After the pause, the ignition control repeats the ignition trial cycle twice more. If the gas system fails to detect ignition after the three attempts, the system will "lock out". No further attempts will be performed automatically. To reset the ignition control electrical power to the ignition control must be interrupted. This can be done by opening the dryer door (stopping the dryer) for 15 seconds. Closing the door and pushing the "Start" button will repeat the ignition trial cycle.

8. MAIN BURNER ADJUSTMENT. The primary air shutter of each main burner must be properly adjusted for the correct air-gas ratio. Loosen the shutter locking screw. Adjust the shutter by closing it sufficiently to give a blue flame with a yellow tip. Next open the shutter until the yellow tips are at a minimum. After adjustment securely lock each shutter in position by tightening the shutter locking screws.

9. DRYER SHUTDOWN. To render the dryer inoperative, turn off the main gas shut off valve and disconnect the electrical supply to the dryer.

DESCRIPTION OF DRYER CONTROL

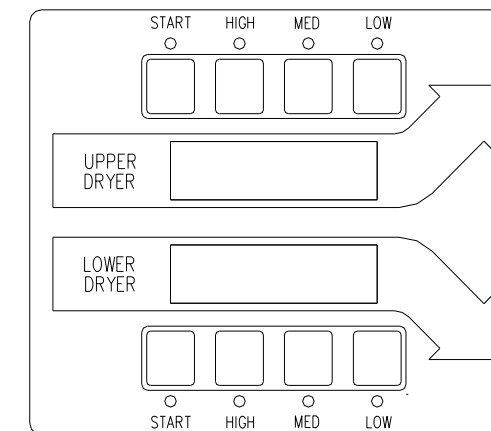

Both dryers are operated by the controller at the left midpoint of the dryer. The controller is two-in-one with the upper display and lights dedicated to the upper dryer and lower display and lights dedicated to the lower dryer.

When money has been deposited, the control will prompt the user to choose a drying temperature and press the "start" button. Time is not added until this occurs for either the upper or lower dryer. If no purchased time is available on the control, the vend price is displayed.

The drying program (temperature) selected by the user is indicated by the red lights at the top and bottom. When the dryer is in use, the drying temperature may be displayed by simultaneously pressing the "start" button and the button of the temperature selected.

OPERATING INSTRUCTIONS

STARTING THE DRYER

1. Load clothes into either the upper or lower dryer (or both). Close the door(s) completely.
2. Deposit coins equal to or greater than the displayed vend price. The control will prompt the user to choose a drying temperature. Time is not added until this occurs for either the upper or lower dryer.
3. Select drying temperature by pressing the appropriate button for the dryer to be used. This will turn on the red light showing the selected temperature.
4. Press "start" button to start dryer. This will display the drying time purchased.

RUNNING THE DRYER

-Opening the door will stop the dryer. The dryer will restart, if time has not expired, upon closing the door and pressing the "start" button.

-Selected temperature may be changed at any time (unless Temperature Pricing feature is activated).

-Running time may be extended by depositing coins and pressing the "start" button for the correct dryer. Unless time has expired, the controller will accept coins whether or not the original vend price is equaled.

If time has run out, the dryer must be restarted as if it was at the beginning of drying the load, which requires meeting or exceeding the vend price.



Section 3: Programing C-Series Stack Dryer

DexterLive

The new DexterLive controls were created for you to be able to interface easier with your equipment and create variable pricing cycles to increase your profitability in the same floor space.

First, log into DexterLive, create your location and equipment list and then create your cycle and pricing information by the particular type of washer and dryer at the location. Once the information is saved, download the "AllUser.xml" file to a USB device which will be used to program the machines from the USB port.

Keep it simple or use the marketing features such as temperture pricing, plus cycle or an additional final rinse that the customer can select for a value added wash. Utilize time of day pricing to help move people from heavy use periods to special value times of day or days of the week.

Through the easy to use USB programing so you can download all special pricing and cycles from DexterLive to set up your store quickly and easily.



Accessible

Available anytime, anywhere, on any internet capable device. Once you have set up your free account all of your custom settings and store information are saved making it quick and easy to make future changes.

Simple

View and customize equipment settings to fit your business model. Download your unique user file and quickly transfer it to your equipment via USB.

Profitable

Create exciting promotions to attract new customers. Offer extra prewash, plus cycles, Extra rinse and temperature pricing to drive more revenue in your store.

First Time Creating an Account at Dexter Live

- 1) Log into DexterLive
At the bottom, select "Create your DexterLive account."

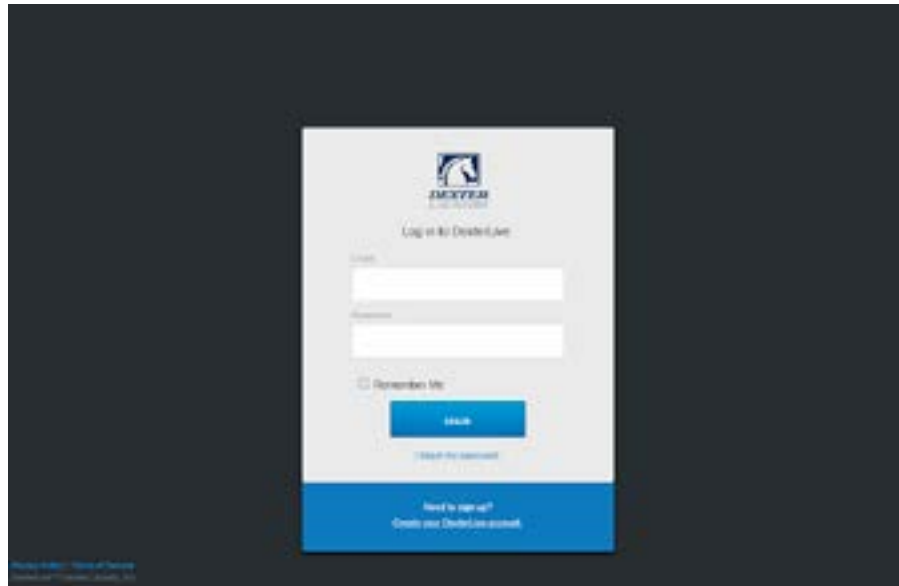

DexterLive gives an owner the ability to manage multiple locations.

- 2) At the "Create a DexterLive Account" screen.
 - A. First time users must create an account.

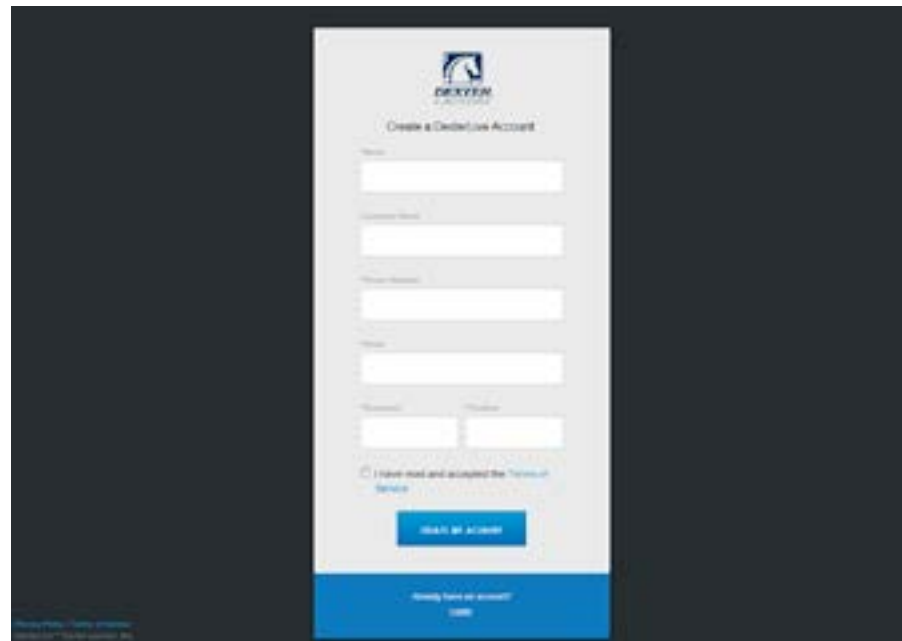

An account must be created to use the DexterLive features.

- B. Fill in the required fields and click on "Create My Account".

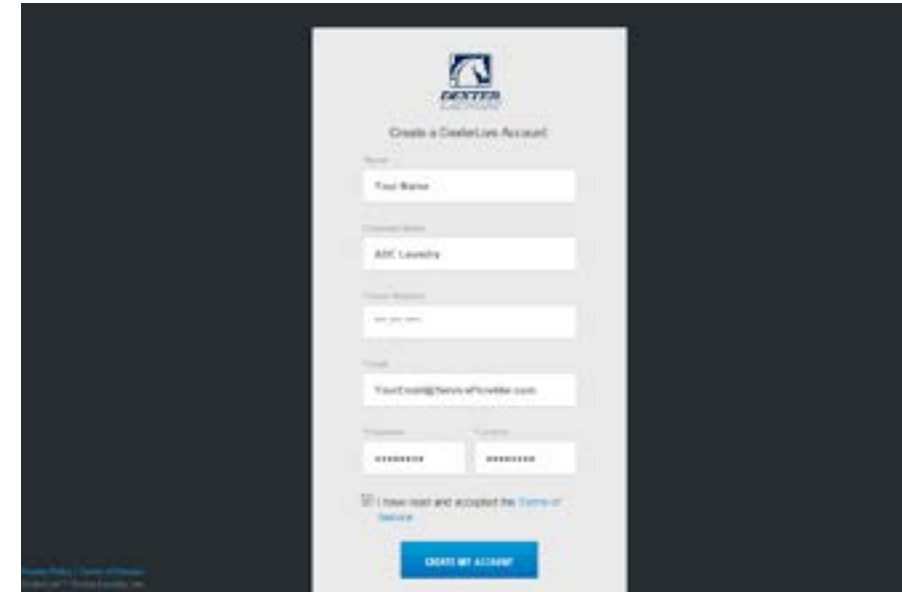

When creating a new user account make sure to fill in all fields marked with asterisks and check the "Terms of Service" box.

- C. After selecting to "Create My Account", you will see the log in screen advising you to go to your e-mail and activate your account.

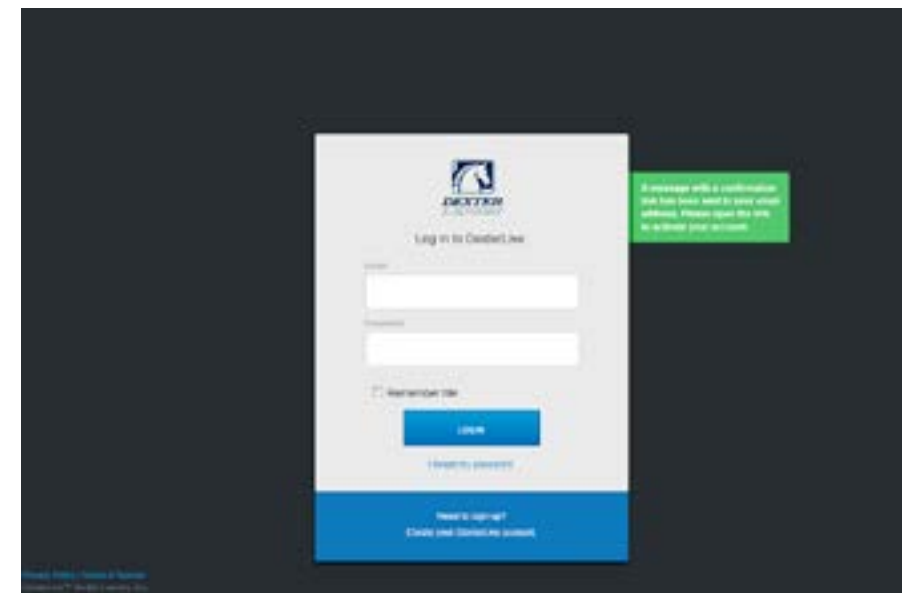

After creating your account you will need to use the e-mail link to gain first access. The account will not be active until you confirm your account.

3) Open the e-mail sent from Dexterlive and select "CONFIRM MY ACCOUNT"

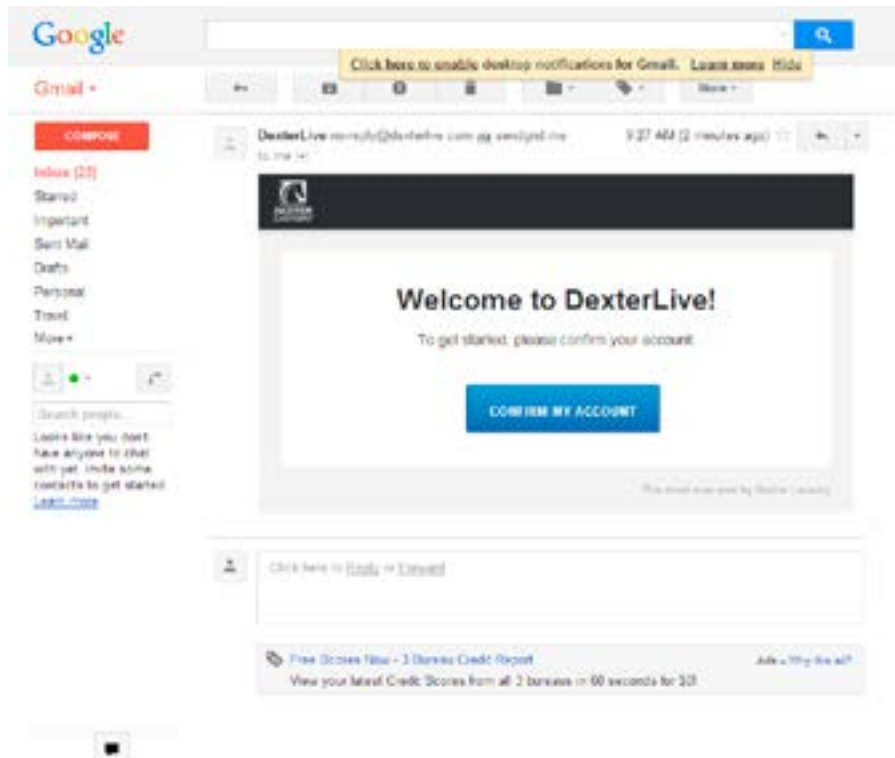

Selecting the "Confirm My Account" hyperlink will take you back to the DexterLive log in page.

4) At the "Log into DexterLive" screen, enter your e-mail/user name and password to access DexterLive.

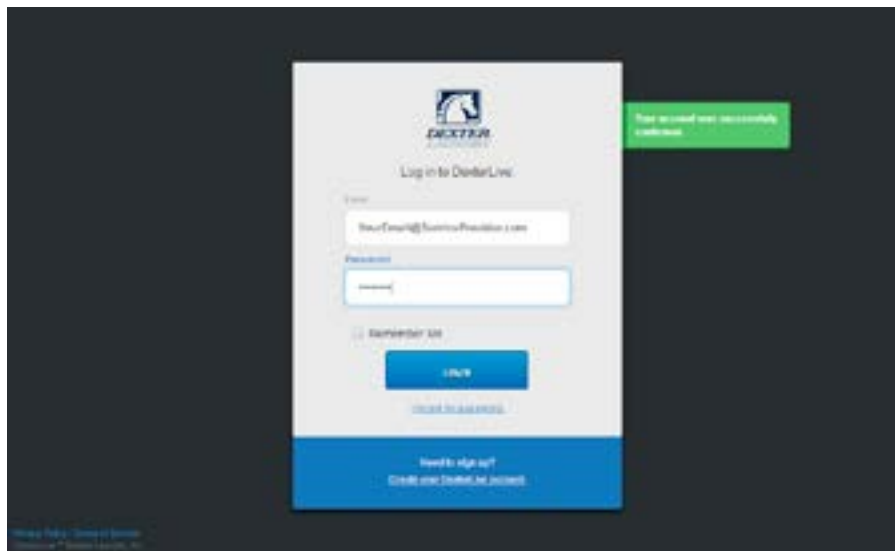

Welcome to DexterLive. Proceed to the step to create your location information.

Programming

5) To configure your settings with DexterLive.com:
A. Add or select a location to program.

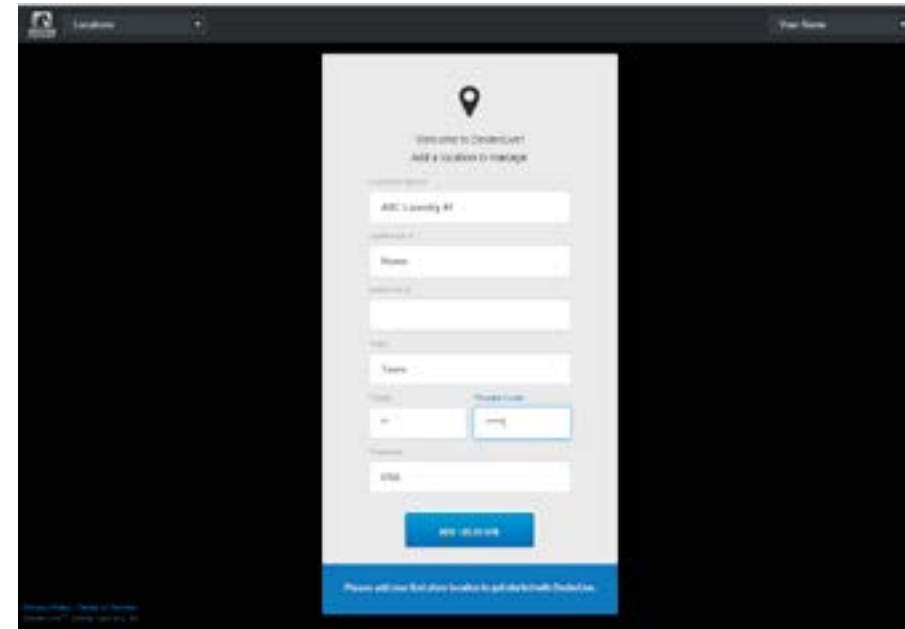

DexterLive gives an owner the ability to manage multiple locations and machines.

B. On the left side of the screen, select the "Programming" tab.

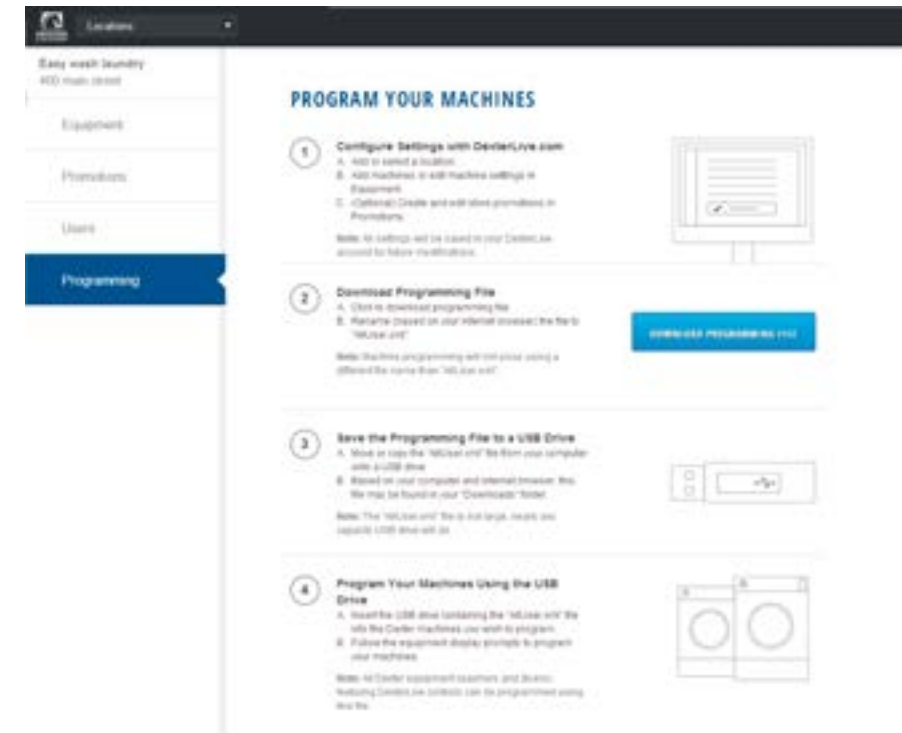

Follow instructions in the programming tab.

C. Edit the "General Settings" (Equipment Tab)

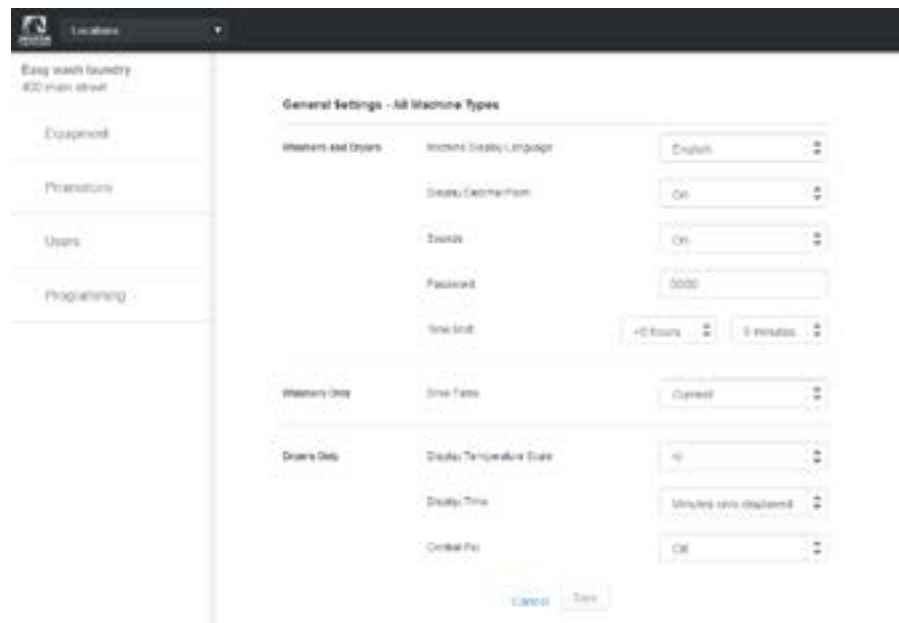

Adjust setting and offset time to match your location. (Time is set for Central Standard Time)

D. Next select the "+Add Equipment" (Equipment Tab), located in the upper right hand corner.

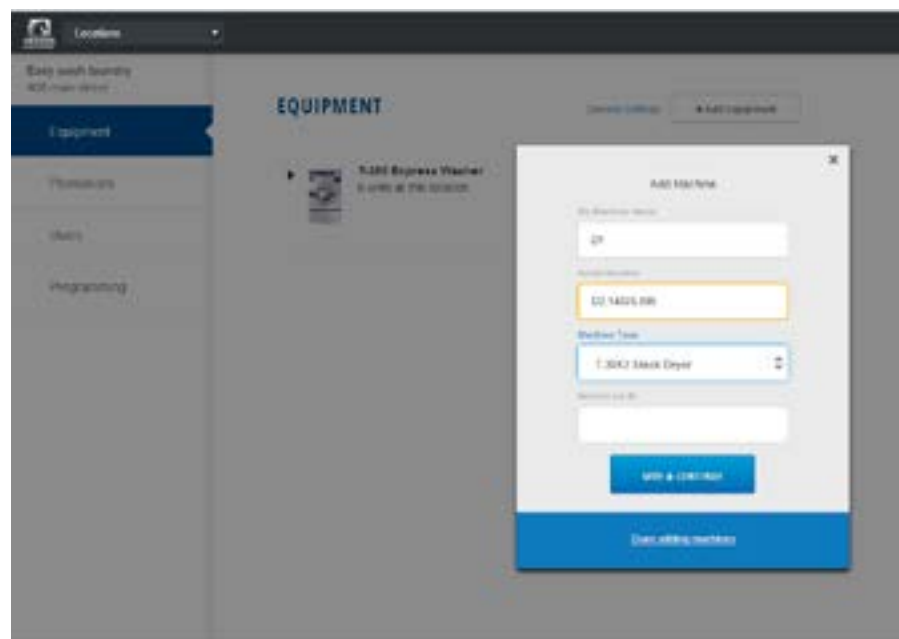

Name of the machine. (Example: Dryer 1) Enter serial number and machine type then select "Save and Continue."

E. When all of the equipment has been added, select "Edit" on the machine type you wish to modify, and then select "Pricing". (Equipment Tab and Machine Settings Tab)

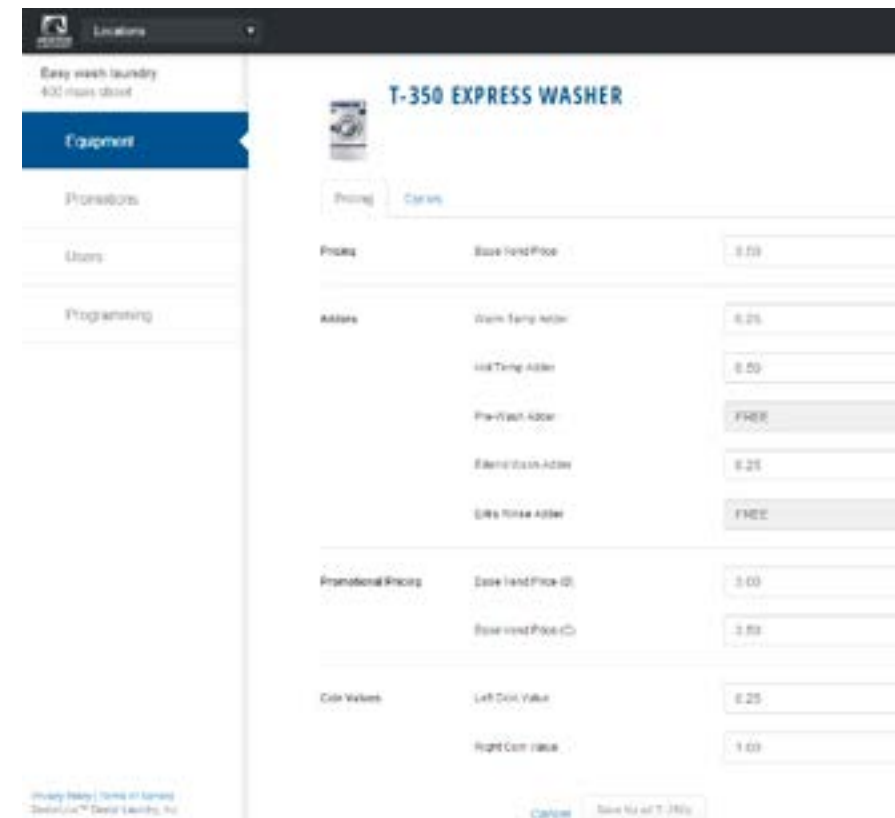

Program the price of the machine and the extra pricing adders.

F. Cycle changes can be made by selecting the "Cycles" tab.

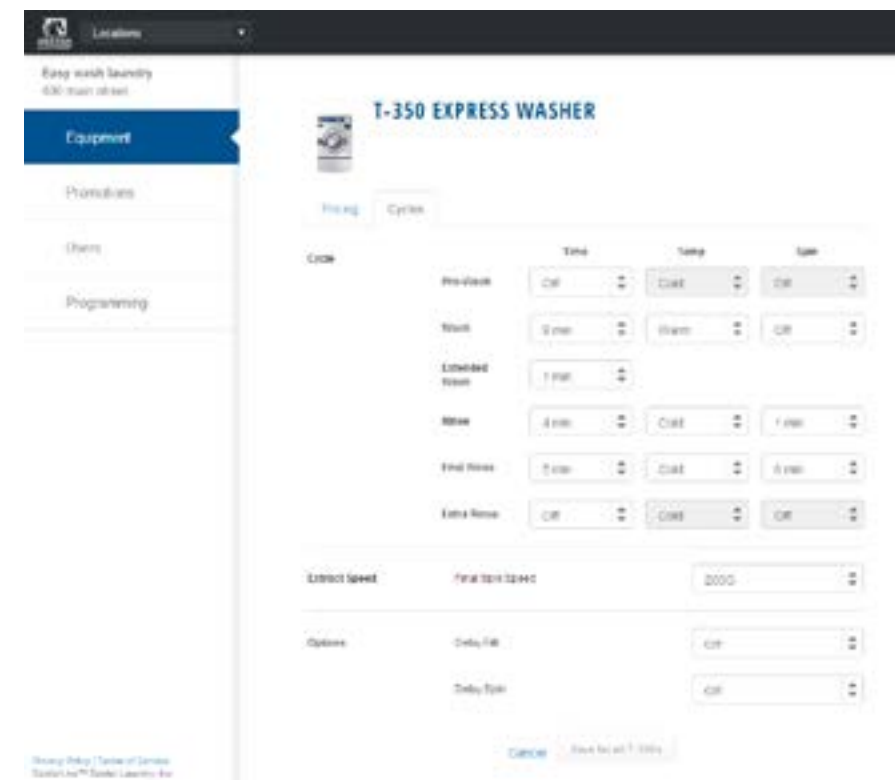

Adjust cycle programming set the length of time and extracts speed as needed.

- G. If desired, you may create and edit optional store promotions from the "Promotions" Tab.

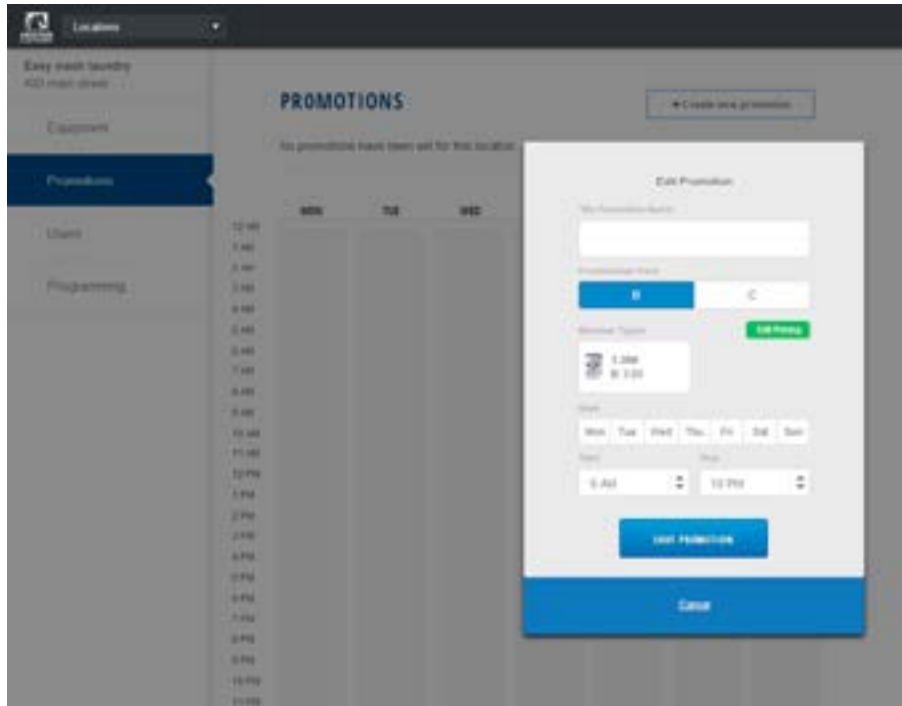

Select "Save Promotion" once your changes have been made.

- 6) Create and download the Programming File.
 - A. Once all preferred prices, cycles and promotions have been modified and saved, select **"DOWNLOAD PROGRAMMING FILE"**.

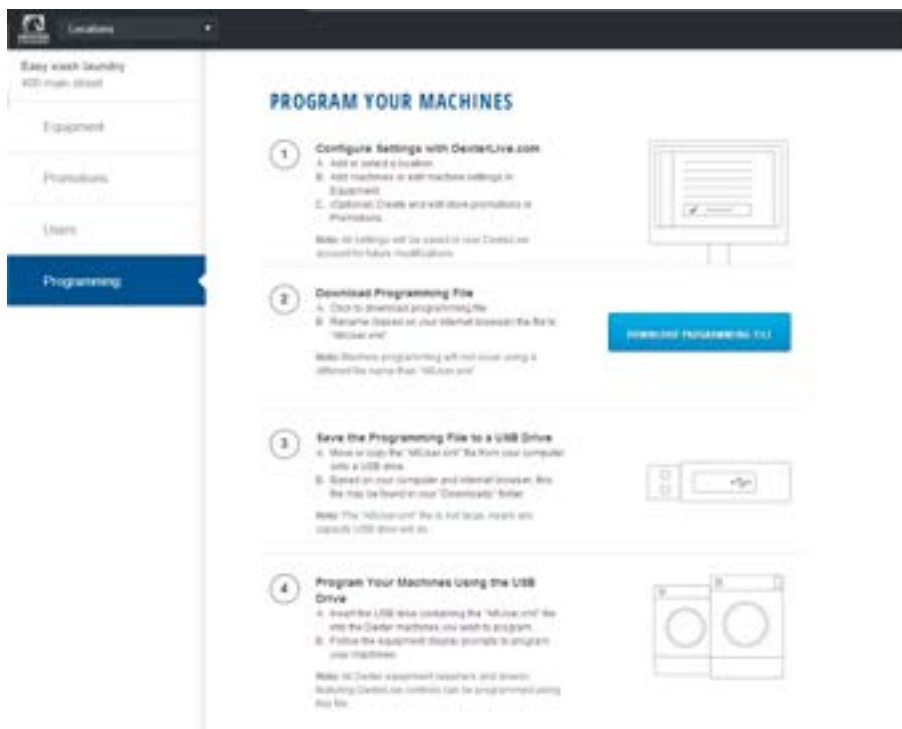

- B. Based on your internet browser the file needs to be saved as "AllUser.xml". Depending on your Internet browser you may need to retrieve the file from your "Downloads" folder, which is located under "Computer".

Note: The newly created programming file may have changed from the proper "AllUser.xml" Machine programming will not occur using a different file name than "AllUser.xml". Any extra extension names will require the file to be renamed back to "AllUser.xml" for the machine to recognize the file.

- 7) To save the Programming File to a USB Drive:
 - A. Move or Copy the "AllUser.xml" file from your computer onto a USB drive.
 - B. Based on your computer and internet browser, this file may be found in your "Downloads" folder, which is located under the "Computer" area.

Note: The "AllUser.xml" file size is small, nearly any capacity USB drive will do.

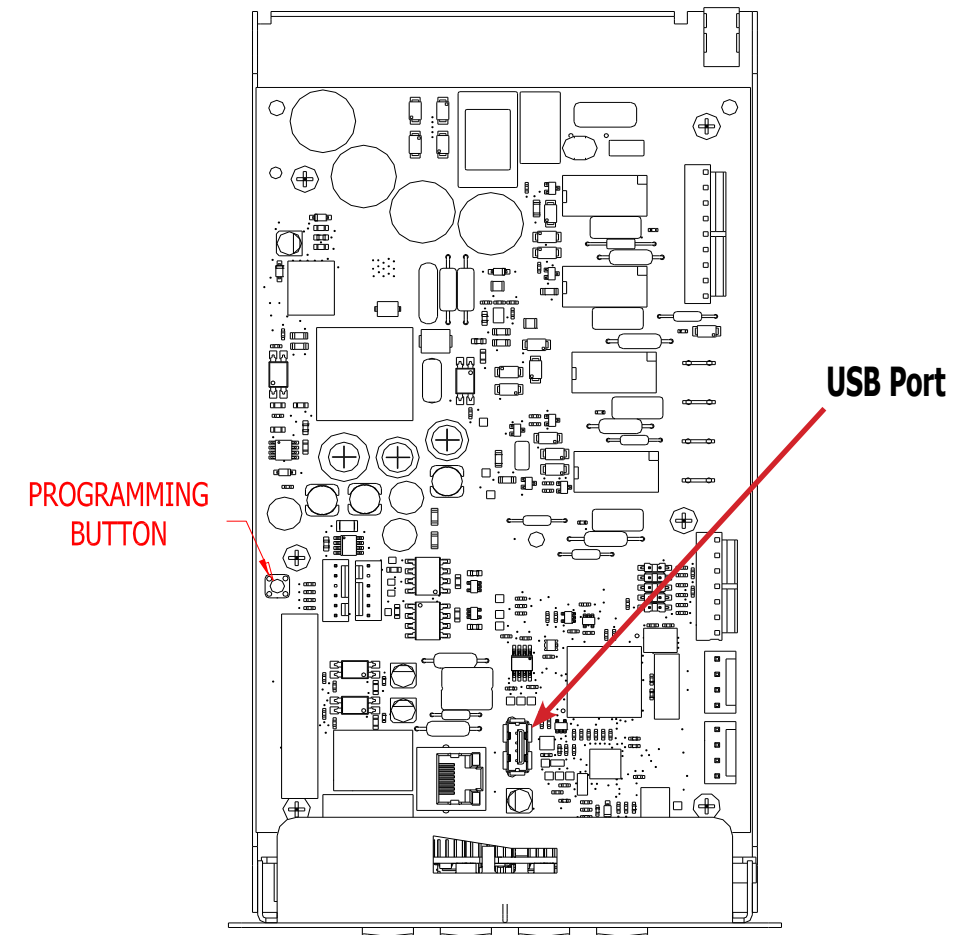

- 8) Program Your Machines Using the USB Drive

CAUTION!!! Be sure that any loose keys or other items that are connected to the USB device are removed from the USB stick to prevent any possible metal contact with the control board.

- A. Insert the USB drive containing the "AllUser.xml" file into the Dexter machines you wish to program. The control will scroll "....." while identifying the program on the USB. Once identified, the display will scroll "INSTALL USER FILE FROM USB". At this prompt press the green start button on the front panel.

- B. The machine will scroll "TO INSTALL – PRESS START". At this prompt, press the green "Start" again.



- C. Once the program is uploaded successfully the control will scroll "DONE REMOVE USB". The USB drive can be safely removed at this point.

Note: All Dexter equipment (washers and dryers) featuring DexterLive controls can be programmed using this file once the equipment has been configured.

PROGRAMMING THE DRYER CONTROL

The dryer control can be programmed to prompt the user for alternate vend prices, change dryer cycle times, temperatures and many other options. This can be accomplished in two ways:

1. Manual programming utilizing the "Start", "High", "Medium" and "Low" buttons for the bottom dryer.
2. USB download of a customizable User File. For instructions on using the USB download feature, please contact your local Dexter distributor or visit DexterLive.com.

MANUAL PROGRAMMING:

The dryer must be in idle mode for the manual programming menus to be accessed. Idle mode is when the dryer is not actively running a drying cycle and the vend price is displayed on the screen (for both upper and lower dryers).

To enter the manual programming mode, the control tray on the dryer must be unlocked and pulled out to reveal the programming button. The programming button is then pressed for 1 second. The control should display "DRYER PROGRAMMING".

See the figure below for the location of the programming button on the control tray.

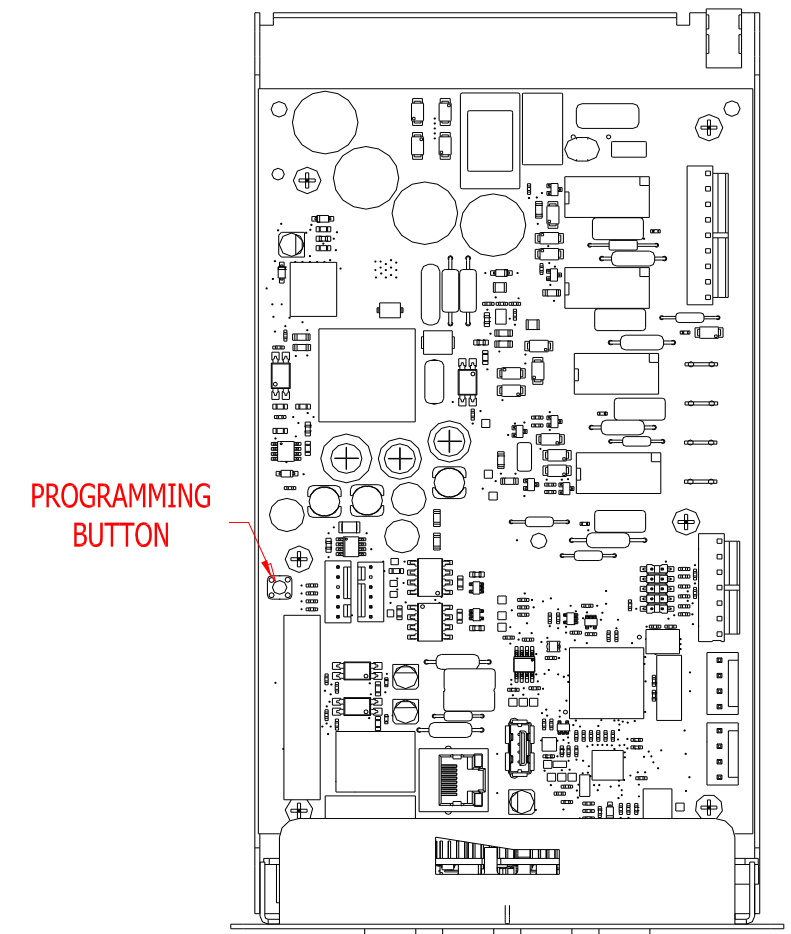

When manual programming mode is entered, the "Start", "High", "Medium" and "Low" buttons for the lower dryer perform alternate functions. Please note that the changes made using the lower dryer buttons affect both upper and lower dryers.

Button Name	Alternate Function in Programming Mode
Start	Becomes the action to accept the displayed option or the "Enter" key
Hot	Becomes the action to move UP through displayed options (Press & hold for accelerated scrolling)
Warm	Becomes the action to move DOWN through displayed options (Press & hold for accelerated scrolling)
Cold	Becomes the action to move back a step (1 press) or EXIT from programming mode (press for 3 seconds)

These alternate functions allow the user to move through a menu of options to choose various programmable settings. The figure below shows the top level menu. Choosing an option from the top level menu will then display the next level of options (the sub menu).

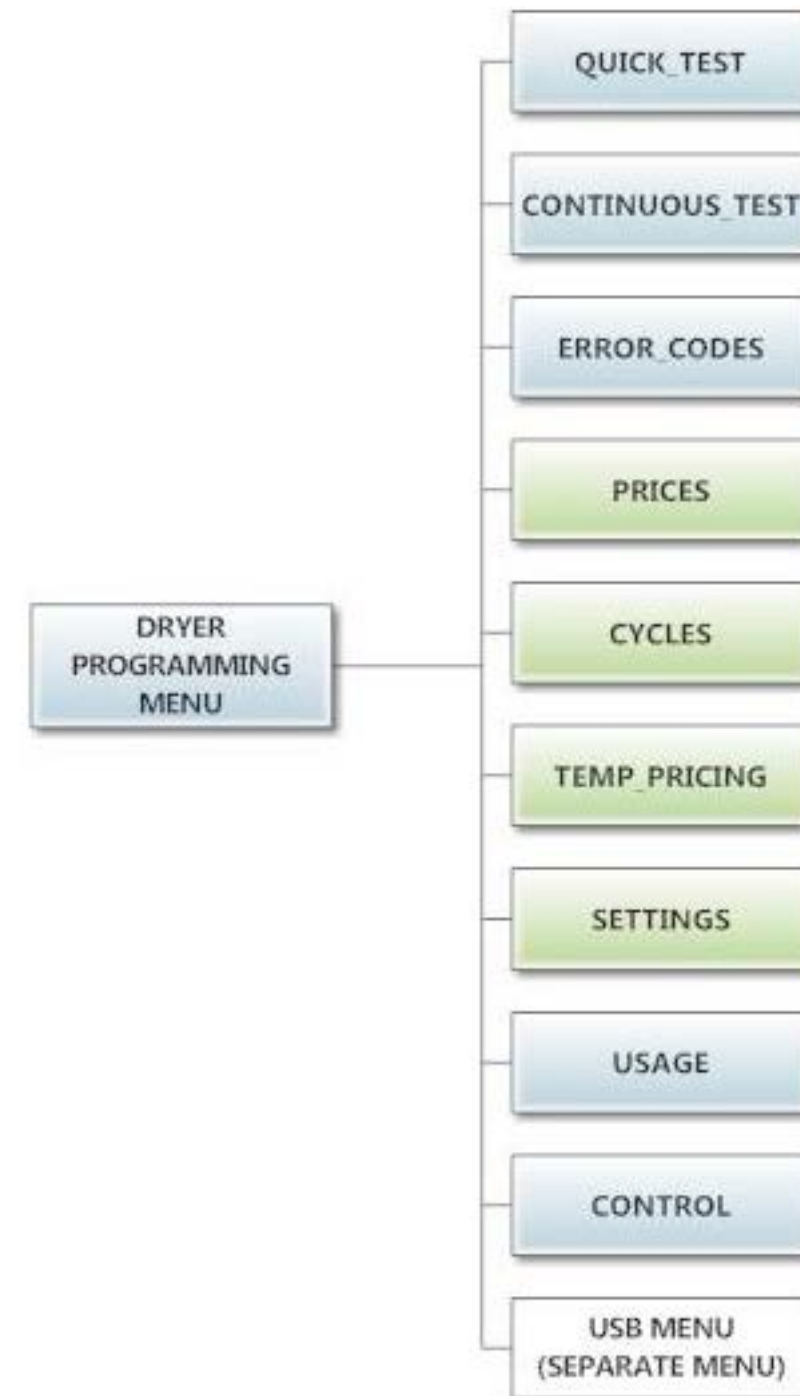

Quick Test Option:

When the Quick Test Option is chosen, the dryer will begin a shortened dry cycle without the displayed vend price being met. The purpose of this shortened cycle is to test all major components for proper operation.

Error Codes should all function normally during this test. The display will show customer prompts in a similar way to a normal dry cycle.

Continuous Test Option:

Similar to the Quick Test, when the Continuous Test Option is chosen, the dryer will begin a dry cycle without the displayed vend price being met. However, in this case, it will be a continuously-running cycle. It will not time out after any designated amount of time.

CAUTION: This option is meant for factory use only. Do not operate the dryer with this cycle active without factory authorization.

Error Code Historical Log:

The last five occurring error codes will be stored in the control with a time and date stamp. The purpose of this option is only to observe the history of these code occurrences (no changes can be made).

The time is based off the Real Time Clock, but potentially shifted by the user's manual programming changes (Shift Hours option) and/or network time override. As additional error codes occur, the oldest of the five logged codes is cleared from memory.

Prices Option:

This option allows the user to set values for coin acceptor inputs, vend price & time and extend dry price & time. It also allows the user to return the values to factory defaults. After changing prices using the "Up" or "Down" buttons, the "Enter" button must be pressed again for the control to store the changes that have been made. Note that, in general, time values are set in 1 minute increments. This can be changed to 30 second increments, by changing the "Display Time" to "MIN+SEC" (refer to the "Settings" section).

1. "RIGHT COIN" and "LEFT COIN" are the two possible inputs from coin acceptors.
2. "PRICE SET VEND" is the actual Base Vend Price (or Vend Price A) that is shown on the control display. The value can be increased or reduced even down to "0". In this case, the displays will prompt "FREE" and the cycle will start as soon as the "Start" button is pressed (without any vend price being met).
3. "TIME SET VEND" is the cycle time that the customer has available once they've met the Base Vend Price.
4. "FREE SET TIME" is the cycle time that the customer has available if the Base Vend Price is set to "FREE".
5. "EXTEND DRY" sets the price and time for additional drying time that becomes available after the customer has already met the Base Vend Price.

To reset either the coin acceptor inputs or the vend price to factory default, press "Enter" when the "DEFAULT" prompt is shown. Press "Enter" again when the "RESET" prompt is shown to confirm the action. Example- A store owner has programmed the control for the following values:

Base Vend Price	\$1.00
Base Vend Time	30 minutes
Extend Dry Price	\$.25
Extend Dry Price	8 minutes

In this case, the customer adds 4 quarters to satisfy the \$1.00 Vend Price. The display shows 30 minutes of drying time. At this point, if an additional quarter is added, the customer display shows an additional 8 minutes of drying time (38 minutes total) as per the Extend Dry Price & Time.

The customer starts the drying cycle and at 25 minutes into the cycle (13 minutes displayed), they add an additional quarter. The controller adds 8 minutes to the displayed time again (21 minutes total) as per the Extend Dry Price & Time.

"AFTER CYCLE" allows the user to choose whether a customer is allowed to add "EXTEND DRY" time for up to 30 seconds after the dryer door is opened after a completed cycle.

Prices Option:

This option allows the user to set values for coin acceptor inputs, vend price & time and extend dry price & time. It also allows the user to return the values to factory defaults. After changing prices using the "Up" or "Down" buttons, the "Enter" button must be pressed again for the control to store the changes that have been made. Note that, in general, time values are set in 1 minute increments. This can be changed to 30 second increments, by changing the "Display Time" to "MIN+SEC" (refer to the "Settings" section).

1. "RIGHT COIN" and "LEFT COIN" are the two possible inputs from coin acceptors.
2. "PRICE SET VEND" is the actual Base Vend Price (or Vend Price A) that is shown on the control display. The value can be increased or reduced even down to "0". In this case, the displays will prompt "FREE" and the cycle will start as soon as the "Start" button is pressed (without any vend price being met).
3. "TIME SET VEND" is the cycle time that the customer has available once they've met the Base Vend Price.
4. "FREE SET TIME" is the cycle time that the customer has available if the Base Vend Price is set to "FREE".
5. "EXTEND DRY" sets the price and time for additional drying time that becomes available after the customer has already met the Base Vend Price.

To reset either the coin acceptor inputs or the vend price to factory default, press "Enter" when the "DEFAULT" prompt is shown. Press "Enter" again when the "RESET" prompt is shown to confirm the action. Example- A store owner has programmed the control for the following values:

Base Vend Price	\$1.00
Base Vend Time	30 minutes
Extend Dry Price	\$.25
Extend Dry Price	8 minutes

In this case, the customer adds 4 quarters to satisfy the \$1.00 Vend Price. The display shows 30 minutes of drying time. At this point, if an additional quarter is added, the customer display shows an additional 8 minutes of drying time (38 minutes total) as per the Extend Dry Price & Time.

The customer starts the drying cycle and at 25 minutes into the cycle (13 minutes displayed), they add an additional quarter. The controller adds 8 minutes to the displayed time again (21 minutes total) as per the Extend Dry Price & Time.

"AFTER CYCLE" allows the user to choose whether a customer is allowed to add "EXTEND DRY" time for up to 30 seconds after the dryer door is opened after a completed cycle.

The figure below shows the sub menu options for Prices:

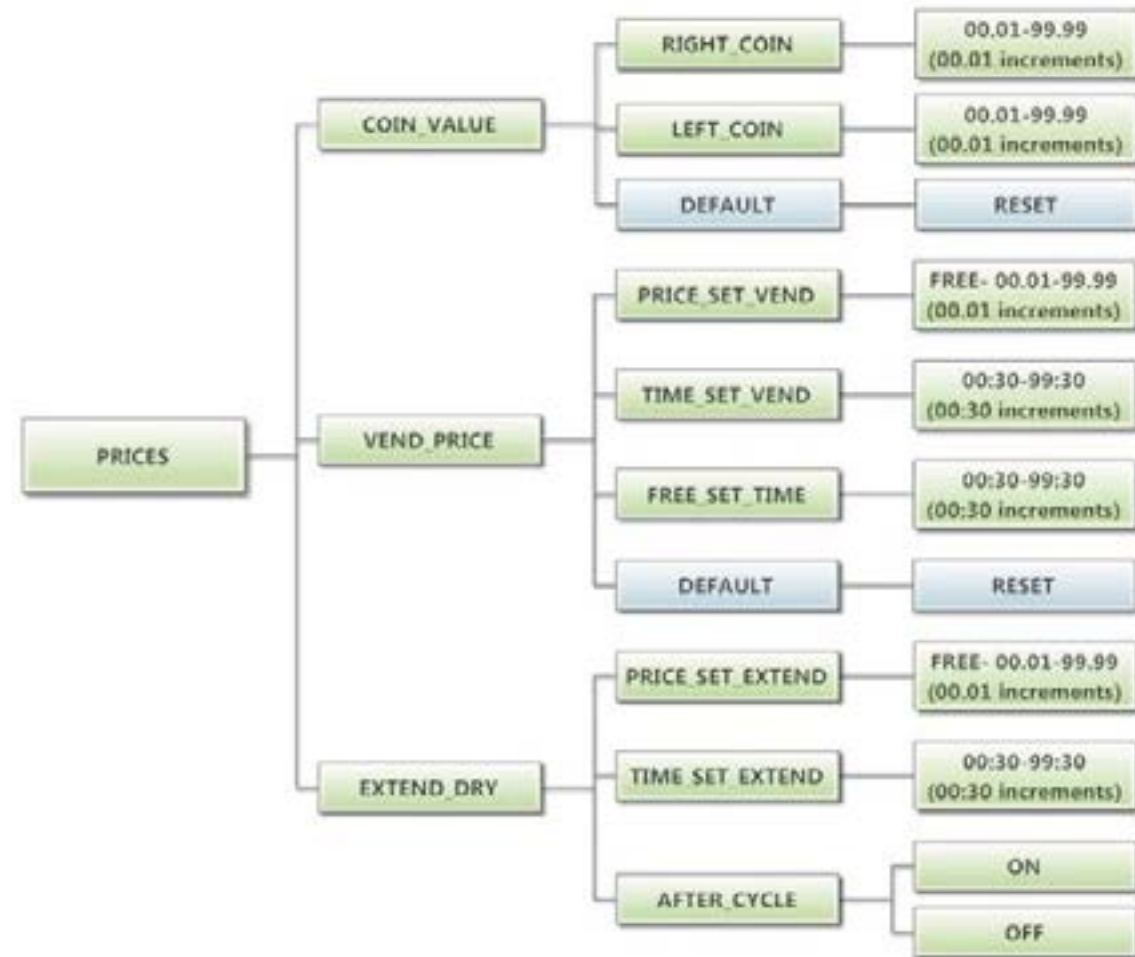

Cycles Option:

This option allows the user to set temperature and cooldown information for the drying cycle. It also allows the user to return the values to factory defaults.

1. "TEMP SETTINGS" allows the user to make adjustments, within a designated range, to the cycling temperature for each of the "Low", "Medium" and "High" customer choices.
2. In addition, on the "Low" setting, the user can reduce the cycling temperature below 110 degrees F. In this case, when the customer chooses the "Low" setting, the dryer will not turn on the gas valve. When checked, the displayed temperature will read "NO HEAT".
3. "COOLDOWN" allows the user to change the designated time at the end of a cycle where the gas valve relay is turned off. On "High" and "Medium" temperature settings, the designated time cannot be reduced to less than 2 minutes.
4. "DEFAULT TEMP" allows the user to choose which general temperature setting, "High", "Medium" or "Low", the control will default to at the beginning of each cycle if the customer does not make a choice.
5. "ANTI WRINKLE" is a feature that periodically rotates the dryers after a cycle is complete. If the door was closed at the end of the cycle, and is left closed for 5 minutes, the enunciator will sound and the display begins scrolling "ANTI WRINKLE". 5 seconds later, the dryer motor will turn on for 60 seconds and then turn off. The gas valves will not be turned on. The "ANTI WRINKLE" message will continue throughout the time that the motor is turned on. The user can choose to enable or disable this feature.
6. "MAX CYCLE TIME" allows the user to set the maximum time that can be purchased for a cycle. This includes the total time purchased before the cycle is started, while the cycle is running, and after the cycle ends.

To reset all values in the Cycles option to factory default, press "Enter" when the "DEFAULT" prompt is shown. Press "Enter" again when the "RESET" prompt is shown to confirm the action.

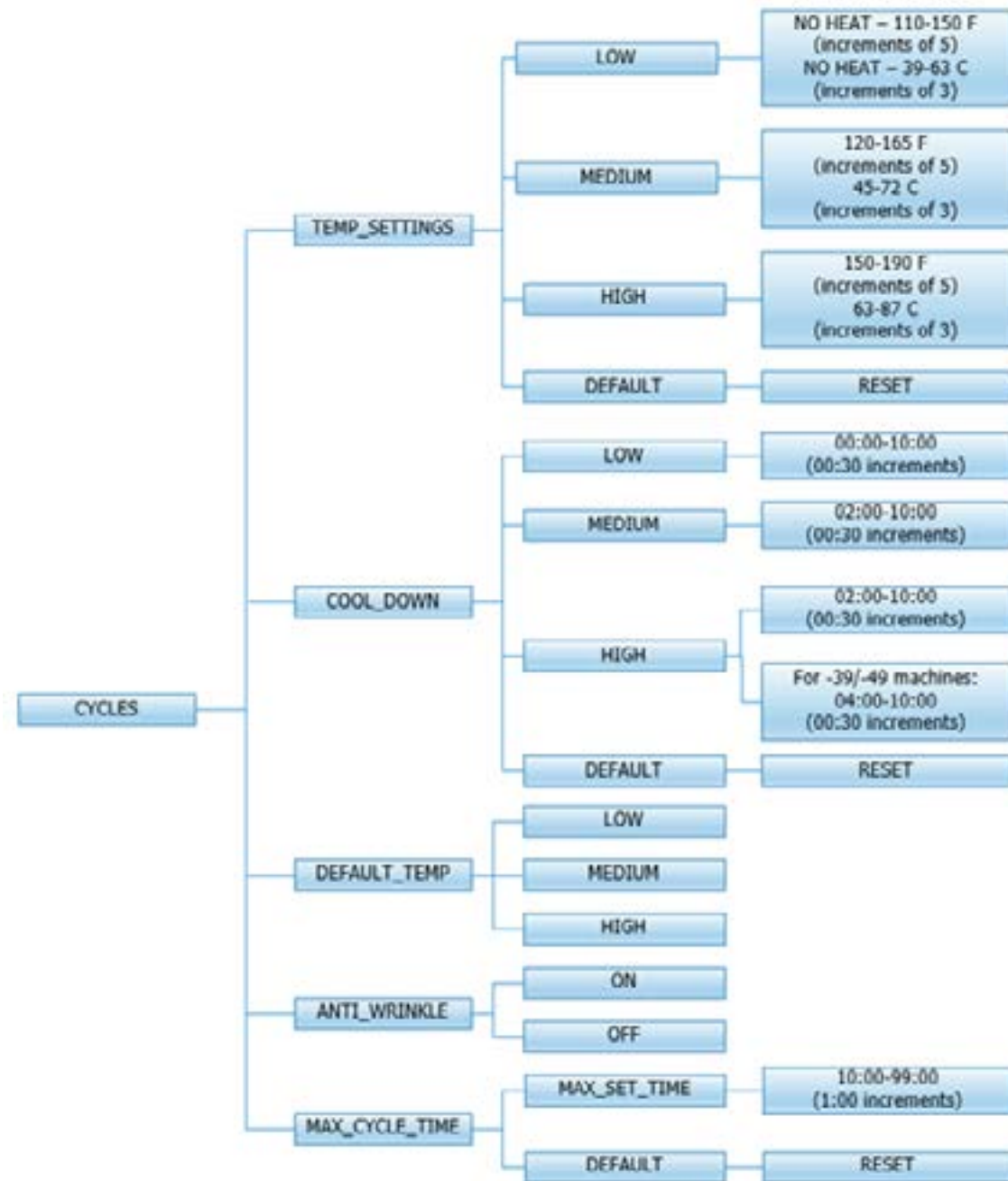

Temperature Pricing Option:

This option allows the user to require additional vend amounts be added based on the drying temperature chosen by the customer. This pricing adder is effective only for the Base Vend Price (it does not affect the Extend Dry Price). It allows a pricing adder separate for "Medium" and "Hot" temperature settings. Example- A store owner has programmed the control for the following:

Vend Price	\$1.00
Vend Time	30 minutes
Extend Dry Price	8 minutes
Medium Adder	\$.25
Hot Adder	\$.50

In this case, the Vend Price is displayed as:
 \$1.00 if Low Temperature is chosen
 \$1.25 if Medium Temperature is chosen
 \$1.50 if Hot Temperature is chosen

When Temperature Pricing Adders are in place (user has chosen a higher value than \$0.00), if the customer attempts to change their temperature selection from a lower temperature to a higher one during a drying cycle, there will be no change in the temperature selection. The higher temperature buttons are disabled until the drying cycle is complete and a new Vend Price is required. The figure below shows the sub menu options for Temperature Pricing:

The figure below shows the sub menu options for Temperature Pricing:



Settings Options:

The Settings options allow for the user to make various programming changes to change how the control operation affects the customer. See below for detailed information on each next level option.

1. "Decimal Point": If the user programs the Decimal Point to "OFF", control display will not show a decimal point on any vend price values. The factory default is "ON".
2. "Display Time": If the user programs this value to "MIN", then minutes only will be shown for the cycle time. If it is programmed to "MIN+SEC", then minutes and seconds will be shown. This also allows other programming changes, involving time, to be made in either minute increments or minutes & seconds increments, as desired.
3. "Temp Scale": If the user programs this value to "F", then the temperatures will be displayed in Fahrenheit units. If it is programmed to "C", then the temperature will be in Celsius units.
4. "Sounds": If the user programs the Sounds to "OFF", the control will not sound the enunciator at the end of a dry cycle. The factory default is "ON".
5. "Password": If the user programs the password to any value other than 0000, the control will prompt the user to enter a password (the programmed value) before manual programming can be accessed. The factory default is "0000" (no password).
 - a. Note that if the user forgets the Password, it can be reset to factory default (no password), by performing a hard reset on the control. Please refer to the appropriate section of this manual to understand how to perform a hard reset.
 - b. The individual digits of the Password can be set by using the "Up" or "Down" buttons to change the number that is flashing. Once the desired number is chosen for a single digit, press the "Enter" button to move to the next one. Once all four desired digits are chosen, the "Enter" button must be held down for 3 seconds to confirm that the complete password should be set.
6. "Central Pay": If the user programs this value to "ON", the left and right coin inputs become upper and lower dryer coin inputs.

Central Pay "OFF"	Central Pay "ON"
Left Coin Input	Upper Dryer Input
Right Coin Input	Lower Dryer Input

A system can then be installed that will register coin inputs per individual dryer remotely from a Central Pay kiosk. The left and right coin prices must be appropriately programmed. When this option is enabled, the controller will only display customer prompts for a designated dryer. This designated dryer is determined when coins are inserted at the Central Pay kiosk.

7. "Language": The control uses English for the default language of the customer prompts. Alternatively, the user can choose Spanish or French for the customer display prompts. However, all other prompts, such as Manual Programming, USB Programming and any Error Codes will still display in English.

8. "Shift Hours": This feature allows the user to shift the time used by the control from the time kept internally by the control. The control uses a Real Time Clock (RTC) to internally track the time and date. The RTC continues operation even if the control loses external power. The RTC is set for Central Standard Time and no daylight savings. Because the machine may be located in another time zone, the user can choose to create an alternate time & date that tracks in parallel to the RTC. When this alternate time is chosen, or shifted from the RTC, the alternate time will be used to, for example, track error code occurrences and set time-of-day pricing changes.

- a. The hours in "SHIFT HOURS" can be set by using the "Up" or "Down" buttons to change the number that is flashing. Once the desired hour shift is chosen, press the "Enter" button to move to the minutes. Once the hours and minute shift are both chosen, the "Enter" button must be held down for 3 seconds to confirm that the complete shifted time is set.

9. "Time": The control uses a Real Time Clock (RTC) to internally track the time and date. The RTC continues operation even if the control loses external power. The RTC is set for Central Standard Time and no daylight savings. However, if a problem occurs and the RTC time is not accurate, it can be reset to the current time using this option.

- a. The hours in "TIME" can be set by using the "Up" or "Down" buttons to change the number that is flashing. Once the desired hour is chosen, press the "Enter" button to move to the minutes. Once the hours and minute are both chosen, the "Enter" button must be held down for 3 seconds to confirm that RTC is meant to be reset to the complete entry.

10. "Date": Similar to "Time", if a problem occurs and the RTC date is not accurate, it can be reset to the current date using this option.

- a. The day of the month in "DATE" can be set by using the "Up" or "Down" buttons to change the number that is flashing. Once the desired day of the month is chosen, press the "Enter" button to move to the month of the year. Once the desired month of the year is chosen, press the "Enter" button to move to the year. Once the day, month and year are all chosen, the "Enter" button must be held down for 3 seconds to confirm that RTC is meant to be reset to the complete entry. To reset all values in the Settings options to factory default, press "Enter" when the "DEFAULT" prompt is shown. Press "Enter" again when the "RESET" prompt is shown to confirm the action.

11. "Out of Service" – The control can be put into an Out-of-Service mode via manual programming. When the mode is "ON", the control will scroll "OUT OF SERVICE" on the display. The machine will not react to any vend input and will not operate when in this mode. The factory default is "OFF".

12. "Alt Cool Down": This setting is for factory use only.

To reset all values in the Settings options to factory default, press "Enter" when the "DEFAULT" prompt is shown. Press "Enter" again when the "RESET" prompt is shown to confirm the action.

The figure below shows the sub menu options for Settings:

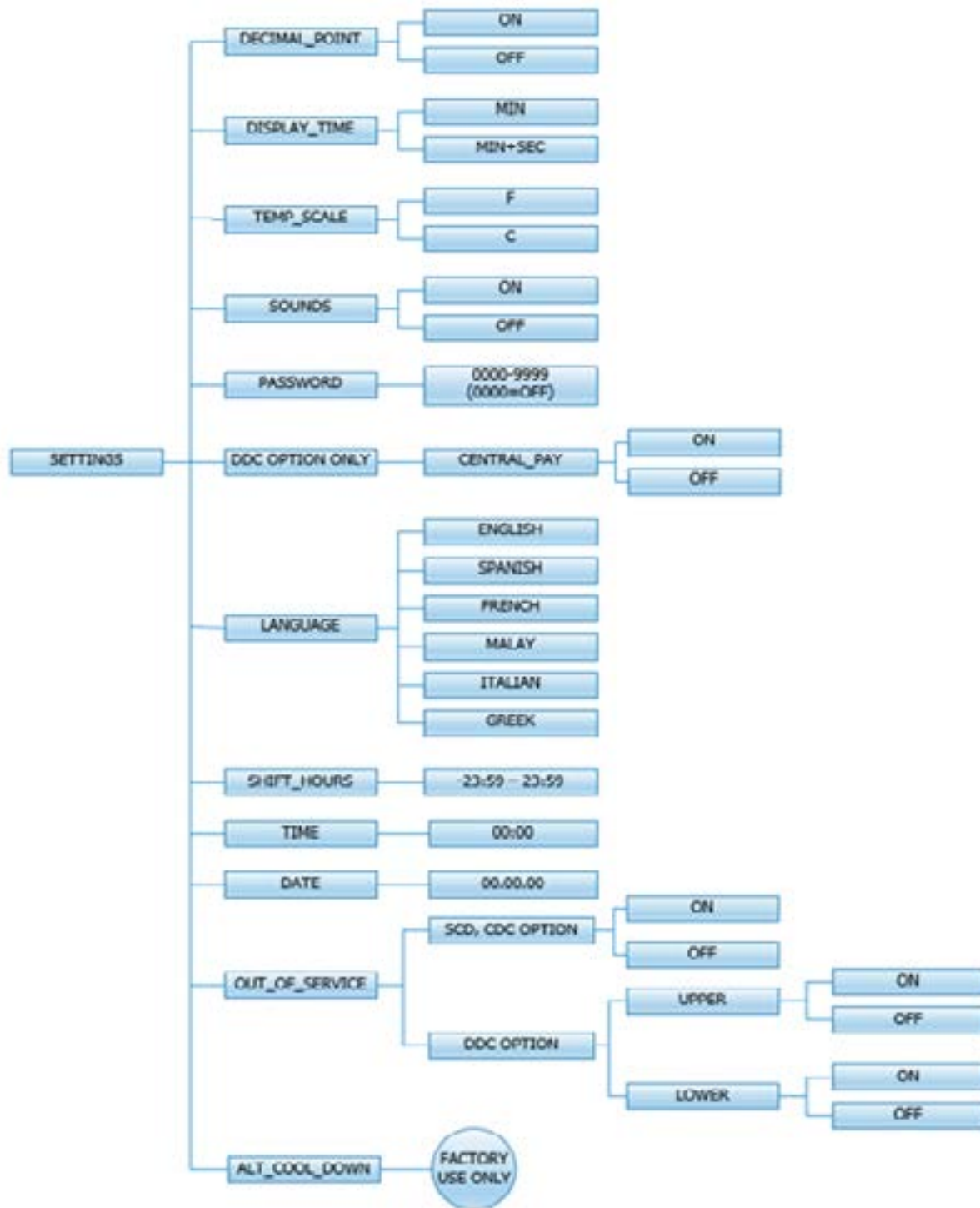

Usage Menu:

The Usage menu allows for the user to track data about machine usage. See below for detailed information on each sub menu option.

1. "Coin Audit": The coin audit field shows the accumulation of coin pulses that were sent to the control over each of the left and right coin inputs. Note that this is a count of coin pulses, not an accumulated report of vend value.
 - a. The user can also return the coin audit amounts to the factory default setting (zero). To reset all coin audit values, press "Enter" when the "DEFAULT" prompt is shown. Press "Enter" again when the "RESET" prompt is shown.
2. "Motor Hours": The motor hours field shows the accumulated hours of operation for both the upper and lower motors independently. In many cases, it will match the cycle hours of the machine. However, separate fields are provided in the event that a motor is replaced on a machine. The user can set the motor hours to a designated number. For example, if it is necessary to replace the control on a machine, the new control could be programmed to show the motor hours that were recorded by the previously installed control. The individual digits of the hours count can be set by using the "Up" or "Down" buttons to change the number that is flashing. Once the desired digit of the hours is chosen, press the "Enter" button to move to the next digit. Once the complete hours are chosen, the "Enter" button must be held down for 3 seconds to confirm the action.
 - a. The user can also return the motor hours to the factory default setting (zero). To reset the motor hours, press "Enter" when the "DEFAULT" prompt is shown. Press "Enter" again when the "RESET" prompt is shown to confirm the action.
3. "Cycle Hours": The cycle hours field shows the accumulated hours of operation for both the upper and lower dryer dryers independently. In many cases, it will match the motor hours of the machine. However, separate fields are provided in the event that a motor is replaced on a machine. See the Motor Hours description for more information.

The figure below shows the sub menu options for Usage:



Control Menu:

The Control menu allows for the user to observe important technical information for the control. No changes can be made at this menu. See below for detailed information on each sub menu.

1. "Serial Number": This is the control serial number.
2. "MAC Address": The MAC Address is a unique identifier designated to the control by the manufacturer. It allows the control to be recognized by network routers.
3. "IP Address": The IP Address is the identifier given to the control by a network system.
4. "M Firmware": The M Firmware is the Main Firmware currently loaded onto the control.
5. "C Firmware": The C Firmware is the Communications Firmware currently loaded onto the control.

The figure below shows the sub menu options for Control:



REVERSING OPTIONS

The dryer can be set to reverse at different intervals dependent on owner's preference. The style of operation is determined by the location of the BROWN jumper wire located in the rear control box, on the frequency drive. (see image for jumper location)

any wires on VFD.

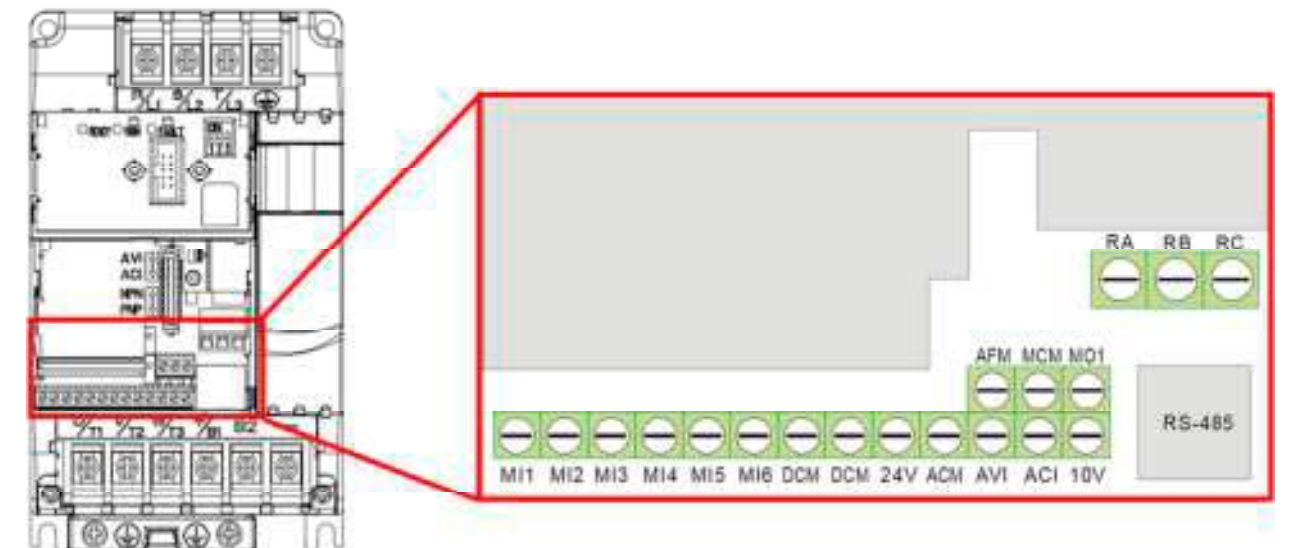

Style	Dryer Operation	FWD (sec)	REV (sec)	Jumper Locations	
				Pos (1)	Pos (2)
1	NON-REV.	YES	NO	DCM	MCM
2	REV.	30	30	DCM	MI2
3	REV.	60	60	DCM	MI4
4	REV.	90	90	DCM	MI5
5	REV.	120	120	DCM	MI6

Section 4:

Schematic

C-Series

Stack Dryer

DC50X2 Reversing 60Hz. Wiring Schematic

Dryer Idle - No Coins Added:

Top Dryer Used For This Example

208/240 VAC 60 Hz. power is supplied to the main power terminal block and comes out on BLK/RED and BLK/BLU wire. 208/240 VAC now passes to the motor control relay (R1&R2) and also passes to the multi-tap control step-down transformer. The same 208/240 VAC 60hz line voltage will also be supplied to the voltage inputs of both variable frequency drives. The control circuit will be powered from the 24 VAC secondary side of control step-down transformer. Power out of the transformer will travel through the 2.5A fuse on the black wire for circuit protection. When there is power to the dryer the computer board will be powered and the display lighted from the 24 VAC secondary side of control step down transformer. 24 VAC from here is also on one side of the door switches on a black wire. Closing the upper loading door allows 24 VAC to pass on to the computer board on two blue wires. One blue wire makes 24 VAC available to one side of the motor run relay on computer board. The other blue wire provides a 24 VAC signal to the computer board telling it that the door is closed and door light on the computer board should be illuminated.

Coins Added - Motor Starting and Running:

Top Dryer Used For This Example

As each coin is added the coin optical sensor completes the coin drop circuit to the computer board. The computer board counts these signals and registers them against time. The time will display once the "Start" button for upper or lower is pushed and the motor run relay closes on the computer. With this relay closed, 24 VAC passes through to the red wire and is supplied to the motor control relay (R1), and the drive enable relay (R3), and also a violet wire going down to the blower motor centrifugal switch. The upper motor LED on the computer board should be illuminated anytime the computer calls for the upper motor to operate. With the (R1) relay engaged and 208/240 VAC passing through to the blower motor start switch, the incoming power 208/240 VAC is supplied directly to the main run winding and through the start capacitor to the auxiliary winding (start winding). The heat circuit in the dryer cannot operate if the blower motor is not running. As the motor comes up to speed, the centrifugal switch inside motor opens the circuit to the start winding and closes the circuit to allow the 24 VAC on the violet wire to pass to through the centrifugal switch to the other red wire and onto the gas relay on the computer board. At the same time the 24 VAC is sent out on the red wire from the computer board to the drive enable relay (R3). When engaged, this allows the DCM common (yellow wire) signal on the drive to pass through to the brown wire MI1 contact on the variable frequency drive. Completing this circuit engages the drive to send the tumble and reversing voltage to the tumbler motor. From the factory, the motor will tumble one direction for 1 minute and then stop and tumble in the reverse direction for 1 minute. This will continue for the length of the cycle. The time of the reversing action can be modified by moving the brown jumper wire on the factory default DCM to MI4 connection. Placing the jumper from DCM to:

MCM – Non-reversing

MI2 – 30 seconds

MI4 – 60 seconds

MI5 – 90 seconds

MI6 – 120 seconds

Heat Circuit

Top Dryer Used For This Example

With the blower motor running, 24 VAC provided through the centrifugal switch on the red wire and connecting to the violet wire to the computer board gas relay. The temperature sensing probe is found under each tumbler in the lint tray area and sends resistance values back to the computer board for temperature sensing. If the computer control senses that the dryer needs heat input, The computer control closes the upper gas relay which passes the incoming 24 VAC from the centrifugal switch back out on the orange wire out of the high limit thermostat. The high limit thermostat is normally closed. (The high limit will open, turning off the heat circuit, if the flame starts moving to the back of the burner housing rather than being pulled into the burner housing due to airflow issues. In this case the high limit will reset on it's own once temperatures are reduced). From the high limit thermostat the 24 VAC travels through to the normally open air flow wwitch (sail switch) on the brown wire. The air flow switch is pulled closed from the vacuum created when the blower fan is producing airflow. With the dryer running and the air flow switch closed, 24 VAC is supplied to the normally closed upper manual reset over-temp thermostat on the gray wire and then passes to the black wire out of switch and then goes to the terminal block where it connects to a violet wire. The 24 VAC then travels to the RC connection at the variable frequency drive. During tumble mode, this connection closes and the 24 VAC then leaves the variable frequency drive through the RB connection on the red wire to the 1.5 amp in-line fuse that fuses the upper ignition controller (grey box). With 24 VAC now supplied to the upper ignition controller (grey box) it will then send high voltage to the spark ignition electrode via the high voltage lead wire (this lead looks like an automotive spark plug wire) and spark is created. The ignition control module (grey box) simultaneously sends 24 VAC to the gas valve coil on the brown wire which opens the gas valve and allows gas to pass to the main burner. When the gas makes contact with the spark, ignition occurs. Once flame is on the burner tube, the flame sensor will send a signal back to the ignition control on the small black wire that the flame is sensed. At this point, the high voltage sparking stops and the ignition control module (grey box) will allow gas valve coil to remain energized and continue burner operation. If ignition does not occur, the ignition control module (grey box) will spark for 10 seconds before locking out. The control box will attempt 3 times total before a complete lock out in the event of no flame sense.

Manual Reset Safety Shutoff Over-Temperature Thermostat

Top Dryer Used For This Example

The over temperature thermostat is a safety backup for the entire heat circuit and located in the recirculation chamber area on the side of the burner housing. If the dryer over heats this over temperature thermostat opens the circuit to stop voltage from passing to the heat circuit which stops the flame. The computer board continues to count down and the drive motor remains powered and turning so the basket will cool down.

Cool Down

Top Dryer Used For This Example

Near the end of the cycle at the preprogrammed time (2 minutes factory setting - adjustable) the computer board will open the gas relay contact. This happens for the remainder of the cycle. The drive motor will continue to run but without heat. The gas light on the computer board should not be illuminated anytime the computer is in cool down mode. This cool down period allows the clothing (zippers, snaps, etc.) time to cool down to a temperature that is easily handled by customers.

End of Cycle

Top Dryer Used For This Example

At the end of the cool down, the computer board opens the upper run relay, which removes power from the blower motor control relay (R1) and also removes power to the (R3) tumble relay which deactivates the variable frequency drive and motor. The motor light on the computer board should no longer be illuminated. The drive motor and tumbler stops and the computer board display now flashes until the dryer loading door is opened. Once the dryer loading door is opened to remove the clothing the display goes back to vend price.

Anti-Wrinkle

Anti-Wrinkle is a feature that periodically rotates the dryers after a cycle is complete. If the door was closed at the end of the cycle, and is left closed for 5 minutes, the enunciator will sound and the display begins scrolling "ANTI WRINKLE". 5 seconds later, the dryer motor will turn on for 60 seconds and then turn off. The gas valves will not be activated. The "ANTI WRINKLE" message will continue throughout the time that the motor is turned on. The user can choose to enable or disable this feature. This feature will continue to occur every 5 minutes until the door is opened or 5 anti-wrinkle cycles are exceeded.

Notes

Wiring Diagram for DC50X2 Dryer

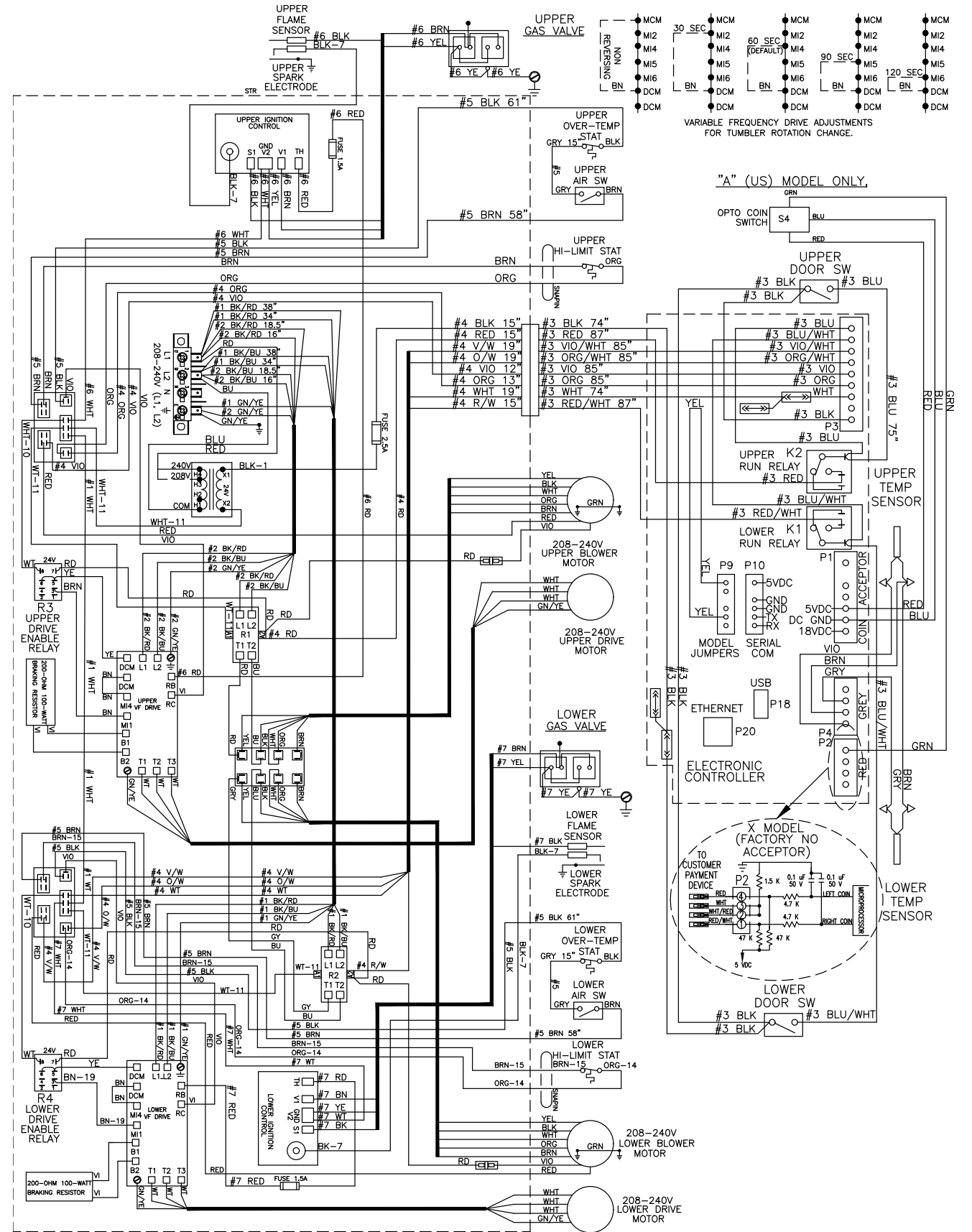

9506-790-001B WIRING DIAGRAM DC50X2NC-11EC_L

IMPORTANT: RETAIN THIS ELECTRICAL DIAGRAM FOR SERVICE.

Section 5:

Service Procedures

Service Procedures

Clothes Door Removal

1. The clothes door may be removed from the hinge bracket by unscrewing and removing the allen-head pivot screw located at the door upper hinge point.
2. Next lean the door out of the top of the hinge bracket and lift the door from the bottom hinge pin.

NOTE: The spacer between the bottom of the door and the hinge.

Clothes Door Latch Adjustment

1. Loosen the lock nut on the latching stud. It is located directly behind the door handle.
2. Open the loading door.
3. Screw the door catch stud in or out as necessary and then retighten the lock nut.

Door Switch Removal And Installation

1. Each door switch is located directly behind the hinge plate of the loading door assembly.
2. The entire switch can now be pulled from the front panel opening.
3. The switch has two clips that hold it in place on the rear of the switch.
4. With the panel removed, you can now squeeze the two clips and allow switch to be pushed back through panel and grasped from the front and switch removed.

Installation Of Clothes Door Window And Gasket

1. Place the clothes door, with its face down, on a solid surface.

NOTE: Prewarming the gasket makes the installation much easier.

2. Install the window gasket on the clothes door flange. The wider lip of the gasket should be on the bottom side or front face of the clothes door and the ridges should be up.
3. Locate the seam at the latching stud.
4. Apply a soapy water solution or rubber lubricant to the gasket.
5. Slide the glass into the middle of the door ring and gasket with half of the glass above the door and half below.
6. While pressing down on the glass, stand the door up and use a modified screw driver with the end rounded off to install half of the glass. Lay the door down and install the other half.
7. At the six o'clock position, pry the glass gasket up enough to install the black spacer. (reuse from old door gasket)

High Limit Thermostat Locations And Functions

A. Burner Housing- The hi-limit is located on the back side of each burner housing.

1. The thermostat opens the circuit to the main burners in the event of malfunction in the gas control area or temperature control. This thermostat will open quickly if there is a significant loss of air flow over the burner area.
2. It is covered by a guard and is held in place by two screws. There are spacers between the thermostat and bracket which must be used to give proper operation.

B. Manual Reset Over Temperature Safety Thermostats- The second hi-limit thermostat is located on the right side of each burner housing as you view from the back of the machine. It is just above the gas valve and covered by a guard with a small access hole.

1. The manually resettable thermostat limits the operating temperature a dryer can reach should some abnormal situation occur.
2. Should one of the thermostats be tripped, that particular tumbler will cease to heat until the thermostat is reset. Once the dryer cools, the thermostat may be reset by inserting a pencil or stick through the opening in the thermostat cover.

REMOVAL: To remove either the hi-limit thermostat on the rear of the burner housing or the over-temperature thermostat on the right side of the burner housing, remove the mounting screws holding its respective guard. Next, remove the terminal of each wires attached to the thermostat. Lastly, remove the mounting screws holding the thermostat to the burner.

Pressure Regulator Adjustment

Use the following procedure whenever it is necessary to check the pressure regulator setting.

NOTE: Any adjustment of the pressure regulator must be made with a manometer attached at the plug in the main burner manifold.

1. Shut off the gas supply to the dryer.
2. Remove the 1/8" pipe plug from the end of the main burner manifold.
3. Attach a manometer to the manifold end.
4. Remove the pressure regulator cover screw on the gas valve.
5. Open the shutoff valve, and operate the dryer.
6. Adjust the pressure for a manometer reading of 3.5" water column gas pressure. (11.0" for L.P.)

NOTE: The main burners must be operating when adjusting the pressure regulator.

7. Shut off the gas supply to the dryer. Remove the manometer and install the 1/8" pipe plug in the manifold.
8. Open the shut off valve, start the dryer and check for gas leaks while the burners are ignited.

Coin Acceptor Removal

Loosen the four screws (Torx #10 driver) mounting the coin acceptor to its retaining bracket.

Do not remove the screws or the retainer will fall behind the panel.

Shift the acceptor up and down to allow the retainer to slide through the panel opening. When removing, the bottom should be brought through the panel opening first. When reinstalling, the top should go in first.

Heat Sensor

This unit takes the place of the regulating thermostat on a mechanical timer dryer. The Heat Sensor is a thermistor. The way these work is fairly simple. As the temperature goes up, the resistance in the thermistor (heat sensor) goes down. As the temperature drops, the resistance in the thermistor (heat sensor) goes up.

Electronic Control Diagnostic Lights

The electronic control has 6 diagnostic lights to aid in service of the dryer. Each pocket has indicator lights for the motor circuit, door switch circuit, and the heat circuit. When the electronic control is carefully unlocked and moved forward these lights are visible on the circuit board. They are each labeled as to function indicated.

1. When either dryer door is closed, the appropriate door light on the computer should be illuminated indicating that the door is closed.
2. When either dryer is running, the appropriate motor light on the computer should be illuminated indicating that the computer is calling for the motor to operate.
3. When either dryer is calling for heat, the appropriate heat light on the computer should be illuminated indicating that the computer is calling for heat.

An example of their function would be troubleshooting an upper dryer pocket that did not heat.

1. Start the machine and insure that it did not heat.
2. Check the upper heat light and see if it is lit.
3. If the heat light is on, this would indicate that the computer was calling for heat and that it was not at fault. You would then go on to check the rest of the heat circuit.

Electronic Control Test Cycle

This test cycle allows the dryer to run for 5 minutes without the need for adding money while servicing. To actuate this 5 minute test cycle enter into the Programming mode and enter into Quick Test.

Electronic Control Removal

Unlock the retaining lock in the control assembly. Slide the control out of the machine holding the control by the metal tray. There is enough wire length to allow removing the control tray from the machine before disconnecting the wires.

Temperature Sensor Testing

If either tumbler display shows an "Open Temp Sensor" or "Shorted Temp Sensor, that is an indication of possible temperature sensor problems for that tumbler. Before replacing a sensor, check the wires and connections of the sensor for damage. The sensor lead wires are very small and care should be used in routing and connecting them. The sensors are located under the tumblers and may be viewed by removing the lint screen. The temperature sensor should have between 30,000 ohms and 60,000 ohms resistance at room temperature if okay.

Temperature Testing

To check the temperature in the dryer tumbler, press and hold the upper or lower start button for the tumbler being checked and while holding the start button also press the temperature button for the temperature to be checked. The display will read out the current temperature.

Temperature Sensor Removal

UPPER - First remove electronic control. Once the control is removed, disconnect temp sensor wires by removing the two gray wire nuts. Remove the two temp sensor mounting screws, 5/16 head, remove temp sensor bracket assy. Remove sensor from bracket and replace and reinstall in reverse operation.

LOWER - To remove the lower temp sensor and bracket it is necessary to remove the lower front panel; note you will have to loosen the upper panel to remove the lower panel, and disconnect the door switch wires. Next disconnect temp sensor wires by removing the two gray wire nuts. Remove the two temp sensor mounting screws, 5/16 head, remove temp sensor bracket assy. Remove sensor from bracket and replace and reinstall in reverse operation.

Upper Front Panel Removal

The loading door does not have to be removed to remove the front panels on this model.

1. Remove the left two screws with finish washers.
2. Remove the right two screws with finish washers, at this time the front panel is loose but connected by the harness to the door switch.

Lower Front Panel Removal

To remove the lower front panel a procedure similar to the upper may be used. However, the bottom of the upper panel must be loosened and pulled out to allow the upper flange of the lower panel clearance to be removed.

Motor Belt Replacement

To replace the motor drive belt the final drive belt should be removed as above. Cut the motor belt and remove. The new motor belt fits inside three of the four motor mounting bolts. To achieve this, remove these three bolts one at a time and slide the belt past each in turn. In this way the motor is always supported by three bolts.

NOTE: All drive belts are self adjusting

NOTE: Always remove power from the machine before changing drive belts or working with the drive system.

Tumbler Pulley Removal and Installation

Remove the $\frac{3}{4}$ " headed bolt and washer on the end of the shaft. Then using a wheel puller, using two $\frac{5}{16}$ " course threaded bolts, thread them into the holes on the pulley and remove pulley. When reinstalling the pulley it is recommended to replace the tolerance ring (9487-234-005). Reinstalling the pulley it is recommended using a 2 $\frac{1}{2}$ " long fully threaded bolt, $\frac{1}{2}$ -13 x 2 $\frac{1}{2}$ ", and fender washers pressing the pulley back into position. Install pulley with new tolerance ring onto the end of the shaft and the bolt with one washer, tighten the bolt drawing the pulley in, once you feel resistance remove the bolt and add additional washers and repeat the process until the pulley is snug against the bearing housing spacer. Once tight remove bolt and washers and install original bolt and washers.

Note: Not recommended to use power tools or torque gun for this process. (This may result in damaging shaft).

Intermediate Pulley and Tension Arm Removal

1. The intermediate pulley is retained with a snap ring. Remove the snap ring and the pulley slides off the shaft
2. With the pulley off, there is access to the self adjusting tension arm assembly. The tension arm assembly may be removed by removing the snap ring that holds it to the tension arm support assembly pin. The arm assembly is replaced as a complete unit.
3. The grease fitting for the intermediate shaft should be greased annually.

Tension Arm Support Assembly Adjustment

The tension arm support assembly may be adjusted for alignment of the intermediate pulley and also to align the belts. The three outer nuts allow the alignment of the pin to be adjusted by pivoting the assembly on the center bolt. The center bolt can be screwed in to allow bringing the complete assembly farther back if necessary for belt alignment.

Motor Blower Assembly Removal And Installation

1. Remove back motor and pulley shields as necessary.
2. Unplug motor harness on side of control compartment. (Follow harness from motor to control housing).
3. Remove Tumbler belt and idler belts, and remove idler tension chain and spring.

4. Lift idler pulley straight up and block up or tie up in the extended position.
5. Remove the seven 7/16 nuts holding the blower motor assembly. Rocking the assembly to the left should allow you to remove the assembly.
6. To remove motor from the blower back plate you need to remove the blower fan from the motor shaft, the blower fan is held in place with two square headed set screws one set screw should go to the countersunk hole in the motor shaft and both screws need green loctite and torque to 165 in./ lbs, and remove the four bolts holding the motor to the plate.

Reverse operation to reinstall.

Air Flow Switch Operation And Adjustment

The air flow switch assembly is part of the ignition safety circuit and insures that the burners don't operate unless there is air flow. When the drive motor and blower are running the flat actuator is pulled in against the back of the dryer closing the switch. If this doesn't happen ignition will not occur. The air flow switch assembly is mounted by two screws through the bracket. It can be adjusted by loosening these mounting screws and moving the switch forward or backward.



Ignition Fuse

The 1 1/2 amp fuse protects the control Circuit. To remove it just twist and pull it out.

Electronic Ignition Module

This machine uses an electronic spark ignition system to directly light the burners in each tumbler.

1. The electronic ignition module for each tumbler is located inside the electrical box. This is the metal box on the back of each tumbler area directly to the left of the final drive pulleys.
2. The red wire from the transformer traveling thru the 1.5 amp fuse and into the module supplies the 24VAC required to operate the entire direct ignition system.
3. The black colored hi-voltage wire (spark plug type) plugs onto the post connector on the module, and the multi-wire plug fits into the side of the module.

Spark Ignition Module Removal

If the ignition modules are mounted on a bracket, see section A. Otherwise, see section B.

A: With mounting bracket

Remove the connector housing of the wiring harness attached to the ignition module. Then, remove the terminal of the hi-voltage cable attached to the ignition module. Next, remove the mounting screws holding the ignition module mounting bracket in the rear control box. Lastly, remove the nuts holding the ignition module on its mounting bracket.

B: Without mounting bracket

Remove all of the terminals of the wiring harness attached to the ignition module. Then, remove the terminal of the hi-voltage cable attached to the ignition module. Lastly, remove the mounting screws holding the ignition module in the control box. If there is no spark or intermittent spark, check black hi-voltage lead wire for damage

NOTE: Proper grounding of the ignition system (yellow wires) is very critical for proper ignition sequence.

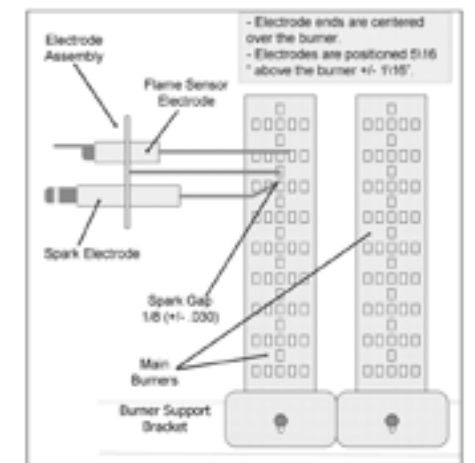

Ignition System-Function & Sequence

During normal dryer operation, the following occurs:

1. The dryer electronic control calls for heat.
2. If the drive motor is running, the motor safety circuit provides power to the electronic control. If the control senses that the heat should be on, a circuit is closed allowing power through the high limit thermostat and air flow switch to the ignition transformer. The transformer provides 24VAC to the ignition module and sparking occurs at the ignition electrode. At the same time 24VAC is applied to the gas valve.
3. Once the flame is established, the sensing electrode detects the presence of flame and the sparking stops.
4. If for any reason the flame is not established in a period of 10 seconds, the electronic control will try this sequence for 3 tries. Normally the 10 seconds "Trial For Ignition" period is ample to establish and prove flame.
5. If the flame is shutdown or blown out during operation, the ignitor will immediately go into "Trial For Ignition" again for 10 seconds.
6. However, at the end of 3 separate retries of 10 seconds "Trial for Ignition", the flame is not established, the ignition system goes into "Safety Lock-Out" and will not reactivate the "Trial for Ignition" until there is a current interruption for a period of 15 seconds. This interruption can be provided by opening the dryer loading door and allowing the machine to come to a complete stop for 15 seconds.

Ignition System-Checkout

1. If flame is present during "Trial For Ignition" period but the system shuts down, there may be an improper ground. The entire ignition system is grounded together including the electrode assembly, the electrode mounting bracket, the burners and the burner bracket. Shutdown can also occur if for some reason the system isn't sensing the flame. Check the sensor for damage and check the connections of the sensor lead.
2. If there is no spark or intermittent spark, check black hi-voltage lead wire for damage or cracks in insulation. (This lead wire must not be taped or connected to any metal edges along its length to prevent pinching and arcing. Also, do not bundle this wire with other wires.)

NOTE: Spark gap and electrode location are important. If the electrode is damaged or mounting is changed the spark gap may not be correct for ignition to occur. Check for cracks in the ceramic insulator. Replace electrode assembly if necessary. Also check for carbon or foreign material on the electrodes and clean if necessary.

Spark Electrode Assembly-Removal

1. Remove electrode cover and disconnect wires to electrodes.
2. Remove two screws to detach electrode assembly.

Gas Valve Removal (shut off manual gas valve to stop gas flow before removing gas control valve)

1. Disconnect union at gas valve and disconnect wires from gas valve operator coils.
2. Remove right manifold mounting bracket screws and slide manifold to remove from left bracket.

Main Burner Orifice Removal

1. Remove manifold and gas valve assembly as above.
2. Using an open end wrench, remove orifices from manifold.

Main Burner Removal

1. Remove the 4 screws securing the cover for the burner housing and the one screw mounting the high limit cover. With the burner housing cover removed, there is complete access to the burner assemblies.

Recirculation Chamber Inspection

1. Remove Resettable manual overtemp sensor and remove inspection plate in burner chamber between main burners and rear back panel of dryer.

Cylinder Removal

1. Remove the front panel in front of the cylinder.
2. Remove drive belt, pulley, and key from cylinder shaft.
3. Pull the cylinder from the front of the machine.

Adjustment Of Cylinder Assembly With Front Panel Removed

1. Loosen the two top adjusting bolts and two bottom adjusting nuts and lock nuts holding the bearing housing to the drive plate.
2. Loosen the four mounting bolts on the side channels.
3. Open the clothes door and insert a 1/4" thick shim at the 3 and 9 o'clock positions and a 1/8" thick shim at the 6 o'clock position.
4. Tighten the two bottom adjusting nuts and tighten locking nuts.
5. Tighten the bottom right mounting bolt, then the top left mounting bolt. Tighten the remaining two bolts. (Shim where and if necessary.)
6. Tighten the two top adjusting bolts.
7. Remove all the shims from between the front panel flange and cylinder (3, 6, and 9 o'clock).
8. Spin the cylinder to check for rubbing baffles, pressing down hard while rotating. If rubbing is detected, repeat procedure paying particular attention to placement of shims between bearing housing and side channels.

Tumbler Through Bolt Access Cover

Remove 4 screws that mount the air flow switch to the back of the dryer. Remove 2 screws that retain access cover. With access cover removed, tightness on the tumbler through bolts can be checked and tumbler alignment can be adjusted.

Bearing Housing Removal

After removing cylinder as previously outlined, simply unbolt the bearing housing and remove.



Section 6: Troubleshooting C-Series Stack Dryer

Trouble Shooting

Electronic Control Diagnostic Lights

The electronic control has 6 diagnostic lights to aid in service of the dryer. Each pocket has indicator lights for the motor circuit, door switch circuit, and the heat circuit. When the electronic control is carefully unlocked and moved forward these lights are visible on the circuit board. They are each labeled as to function indicated.

1. When either dryer door is closed, the appropriate door light on the computer should be illuminated indicating that the door is closed.
2. When either dryer is running, the appropriate motor light on the computer should be illuminated indicating that the computer is calling for the motor to operate.
3. When either dryer is calling for heat, the appropriate heat light on the computer should be illuminated indicating that the computer is calling for heat.

An example of their function would be troubleshooting an upper dryer pocket that did not heat.

1. Start the machine and insure that it did not heat.
2. Check the upper heat light and see if it is lit.
3. If the heat light is on, this would indicate that the computer was calling for heat and that it was not at fault. You would then go on to check the rest of the heat circuit.

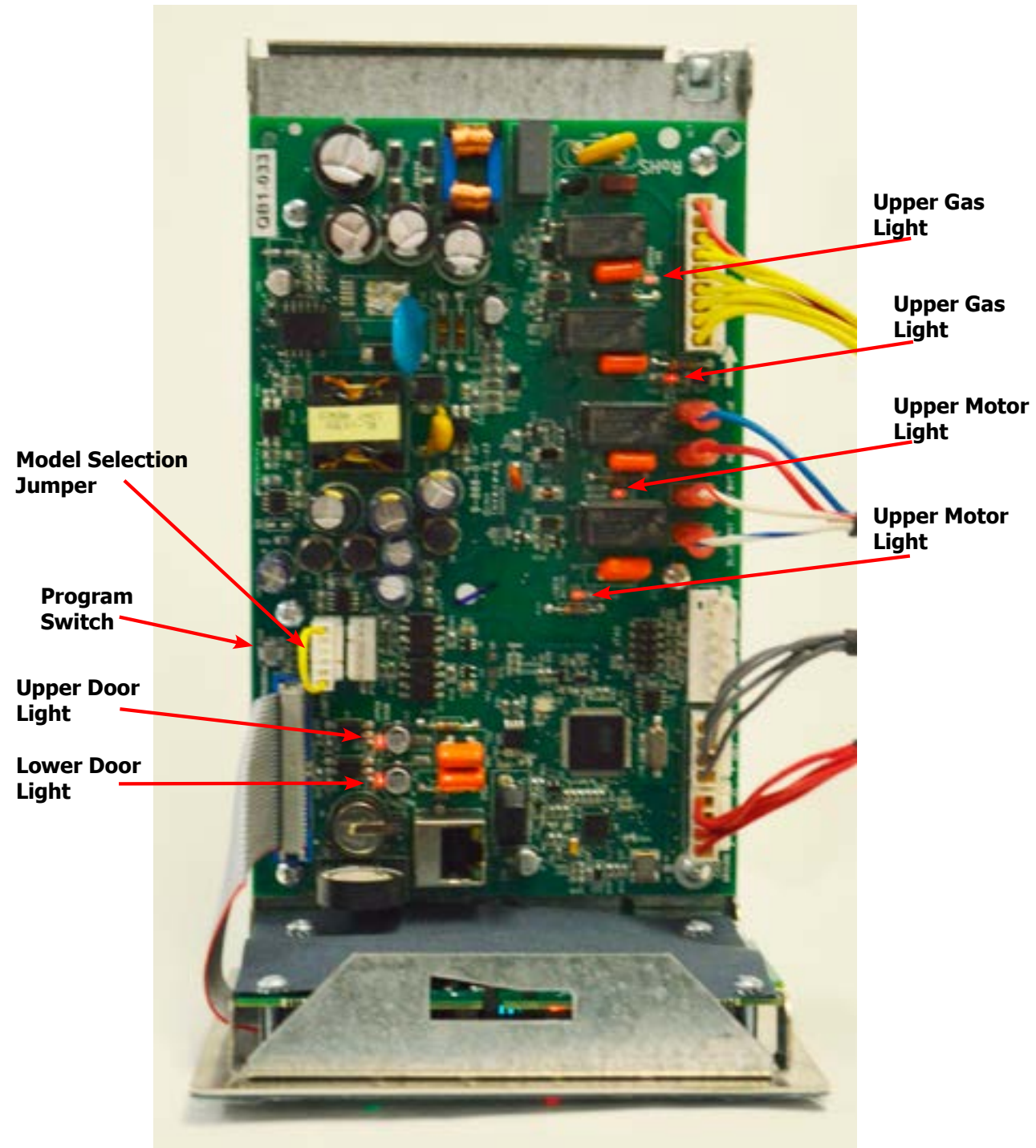

Figure: 1

To enter a test Cycle Mode you will have to enter the programming mode:

MANUAL PROGRAMMING:

The dryer must be in idle mode for the manual programming menus to be accessed. Idle mode is when the dryer is not actively running a drying cycle and the vend price is displayed on the screen (for both upper and lower dryers).

To enter the manual programming mode, the control tray on the dryer must be unlocked and pulled out to reveal the programming button. The programming button is then pressed for 1 second. The control should display "DRYER PROGRAMMING".

See Figure 1

Next press Start and you can scroll through the options you will either want to select Quick test or Continuous Test depending on the length of time you require to perform the tests.

Quick Test Option:

When the Quick Test Option is chosen, the dryer will begin a shortened dry cycle without the displayed vend price being met. The purpose of this shortened cycle is to test all major components for proper operation.

Error Codes should all function normally during this test. The display will show customer prompts in a similar way to a normal dry cycle.

Continuous Test Option:

Similar to the Quick Test, when the Continuous Test Option is chosen, the dryer will begin a dry cycle without the displayed vend price being met. However, in this case, it will be a continuously-running cycle. It will not time out after any designated amount of time.

CAUTION: This option is meant for factory use only. Do not operate the dryer with this cycle active without factory authorization.

Error Codes

Symptom	Probable Cause	Suggested Remedy
TEMP SENSOR SHORT	Shorted Temperature Sensor or wire.	The dryer control shall not start until the detected short circuit is removed. Regardless of condition of short circuit, Error Code will be displayed until programming button is pressed to return machine to idle mode.
TEMP SENSOR OPEN	Open Temperature Sensor or wire	The dryer control shall not start until the detected short circuit is removed. Regardless of condition of short circuit, Error Code will be displayed until programming button is pressed to return machine to idle mode.
PCB ERROR1	Memory corrupted	Power machine down and try to reset control. Vary voltage to the control board. Check ground to board. Replace control board if error can not be cleared
PCB ERROR2	Analog/ Digital Error	Power machine down and try to reset control. Vary voltage to the control board. Check ground to board. Replace control board if error can not be cleared
COMM ERROR1	Communication Bus Error	Power machine down and try to reset control. Vary voltage to the control board. Check ground to board. Replace control board if error can not be cleared
COMM ERROR2	No Dryer Model selected	This error occurs when a pin combination on the model selection header is used that does not have a model designated for it. check connector marked Jumpers on the control board.
COMM ERROR7	Communication Bus Error	If a state-of-health message reply is not seen by the master microprocessor from the UC3 microprocessor after 10 minutes, the master will reset the UC3 and restart the 10 minute timer. Again, after 10 minutes, if a state-of-health message is not received by the master, it will reset the UC3 a second time. After 10 minutes, the master will reset the UC3 a final time and post a COMM ERROR 7. Note: When the master resets the UC3, the control will disconnect from the network. If the first reset is not successful, the control will not be able to reconnect to the network, USB or card reader functions.
FUSE ERROR	programming error	This error occurs when the fuse settings have not been set correctly during factory programming, Replace Control
CRC ERROR	Firmware corrupted	This error occurs the dryer control firmware fails a CRC check. Replace Control

TROUBLESHOOTING

Symptom	Probable Cause	Suggested Remedy
Tumbler does not turn	Drive belts	Check both drive belts. Replace if failed.
	Drive motor	Check capacitor and motor. Replace if failed
	Door switch	Check for door closed L.E.D on control board. Check door switch contacts and adjustment. Adjust or replace door switch.
	Electronic control	Is electronic control closing motor relay to power drive motor? Check for motor light on electronic control. If no light and time counting down, change control. If light is on, check for proper voltage and wiring to motor relay in rear control compartment.
	Motor run relay	Test for proper voltage to run relay coil, Test output voltage of relay when contacts ingauged. if no voltage replace relay.

Symptom	Probable Cause	Suggested Remedy
Tumbler turns but no spark at burner	Glass fuse	Check small glass control fuse in back of dryer. Replace if failed.
	Temperature sensor	The temperature sensor should have between 30,000 ohms and 60,000 ohms resistance at room temperature if okay. Replace if not in this range.
	Ignition	Check for 24VAC output from transformer.
	Transformer	Replace if have 120V between black & white and no 24V between red and yellow.
	Over temperature	Check to see if manually resettable thermostat. Thermostat is kicked out. Reset by pushing red reset button.
	Ignition control	Check for 24VAC coming into the control on the at burner red wire. If voltage, then check for 24VAC out on the brown wire. Also check for spark at the ignitor. If no 24VAC output or no spark to the ignitor, replace ignition control.
	Air flow switch	Check air flow switch to be sure it closes when dryer is running. If not, adjust or replace switch.
	Hi-limit	Check for continuity. Should be 0 ohms resistance when cold. If not, replace thermostat.
	Gas supply	No gas can cause system lockout
	Electronic control	Is electronic control closing gas relay to power Control heat circuit? Check for gas light on electronic control. If no light change control. If light is on, check voltage and components in heat circuit at transformer at rear of unit.

Symptom	Probable Cause	Suggested Remedy
Tumbler turns, ignition sparks, no flame	Gas supply	Make sure gas supply is working.
	Gas pressure	Make manometer check of gas pressure. Adjust if necessary.
	Spark electrode sensor	Check for damage to electrode or mounting. Replace if necessary.
	Gas valve	Check coil continuity, replace valve if failed.
	Ignition Control	Check for 24VAC to gas valve coils. If no voltage replace ignition control.
	Burner Lights, but goes on and off	Electrodes
Slow drying	Temperature Setting	Check program for correct high temperature setting. Adjust if necessary.
	Air flow restrictions necessary	<ol style="list-style-type: none"> 1. Check lint screen and clean if necessary. 2. Check exhaust for correct length and clean if necessary. 3. Check exhaust damper to insure that it opens when dryer is running and closes when dryer is not in use. 4. Check makeup air to insure that it is adequate. Increase makeup air if necessary. 5. Check static Back pressure no more than .3
	Temperature sensor	The temperature sensor should have between 30,000 ohms and 60,000 ohms resistance at room temperature if okay. Replace if not in this range.

Symptom	Probable Cause	Suggested Remedy
Erratic display	Initial start-up	If erratic on initial start-up, leave power on for approximately one hour and check machine operation again.
	Grounding	Machine must be grounded by separate conductor back to neutral bar in breaker box.
	Program	Check program and make corrections if necessary.
	Voltage spike	Power down machine for 20 seconds and repower. If no improvement, replace control.
Manual overtemp tripping frequently	Recirculating chamber Lint accumulation	Remove manual overtemp thermostat and inspect in chamber for excessive lint build up. Access also gained to this chamber by removing recirculation duct mounted at bottom of chamber, or the panel inside burner chamber between burners and rear back panel
	Exhaust ducting Excessive lint buildup	Remove exhaust duct at rear of dryer and inspect for excessive lint build up in complete duct from dryer to where duct exits building.
	Clean lint of of top heat air chamber above tumbler	Remove front panel completely. Be careful of any wiring attached. Remove heated air chamber cover and clean above tumbler back to burner housing.

Notes

Kits, Assemblies, & Common Parts

DC50X2 -11

Description	Model
LINER-BAFFLE,RIGHT(DDBD50 & newer),PTD	9354-013-002
LINER-BAFFLE,LEFT(DDBD50 & newer),PTD	9354-014-002
Optical Coin Switch	9801-099-002
Kit - A to C series Conversion, Black, 120v	9732-307-002
Kit - A to C series Conversion, Blue, 120v	9732-307-001
LP to Natural Conversion Kit for White Rodgers	9732-142-004
LP to NG Conversion Kit for 9857-134-001 & -002	9732-142-002
50X2 Reversing Temp Sensor Cover Kit	9732-349-001
Temperature Probe	9501-004-003
Controls Blue	9857-198-002
Controls Black	9857-198-004
Coin Drop	9021-092-002
Optical Sensor	9801-099-001
Coin Drop Screws	9545-053-002
Ignition Control Box	9857-182-001
Electrode Assembly, Ignition	9875-002-003
Thermostat, Hi-Limit	9576-203-002
Thermostat, Overtemp	9576-207-008
Fuseholder	9200-001-002
Fuse	8636-018-001
Motor Run Relay	5192-299-002
Transformer, Ignition	8711-013-001
Lint Screen 15/18 by 15/18 .010 Wire	9555-057-008
Air Flow Switch	9536-461-009
Door Switch	9539-487-001
Motor Belt	9040-076-009
Tumbler Belt	9040-073-011
Tension Arm Complete	9861-022-001
Spider/Trunnion	9568-013-001
Door Handle	9244-093-001
Cleanout Duct Assembly 8"	9973-034-001



Section 6:

Parts Data

DC50X2 -11

Reversing Dryer

Cabinet Group

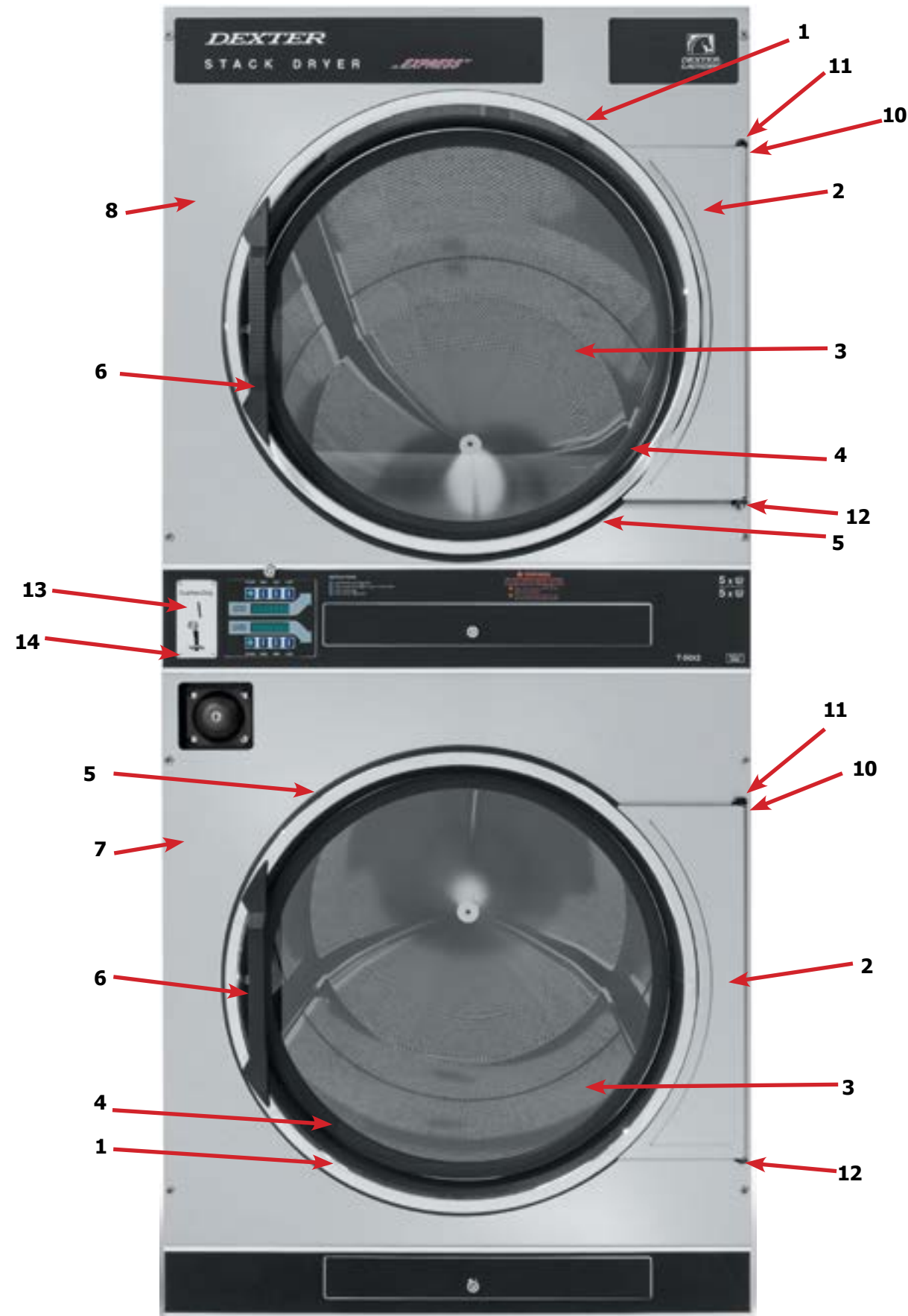

Key	Description	F30X2-11 Reversing	QTY
*	Door Assy., Loading Complete-Wht	9960-285-008	2
*	Door Assy., Loading Complete-SS	9960-285-011	2
*	Door Assy., Loading Complete-Chrome/BLK/SS	9960-285-007	2
1	Door Assy., Loading-SS(ring only)	9960-284-002	2
1	Door Assy., Loading-Chrome(ring only)	9960-284-004	2
2	Plate Assy., Hinge (Wht)	9982-353-002	2
2	Plate Assy., Hinge (SS)	9982-353-001	2
*	Screw, Hinge to Door	9545-012-015	8
*	Nut, Hinge to Door	8640-413-002	8
*	Cover, Hinge Plate	9074-340-002	2
*	Screw, Phillips-10B x 3/8	9545-008-010	4
3	Glass, Door	9212-002-004	2
4	Gasket, Glass Black	9206-413-002	2
*	Support, Door Glass	9548-117-000	2
*	Tool Install Dryer Door Gasket	8545-064-001	1
5	Gasket, Outer Rim Black	9206-420-005	2
6	Handle, Loading Door	9244-082-001	2
*	Screw, Handle 1/4-20 x 3/8	9545-018-017	4
*	Stud, Door Catch, 7/8	9531-033-003	2
*	Nut, Hex	8640-413-001	2
*	Nut, Acorn	8640-413-003	2
*	Catch, Loading Door	9086-015-002	2
*	Pop Rivet for mtg. catch	8638-190-009	4
*	Lockwasher	8641-582-006	4
*	Spring Nut (Before Serial D1.21180.036)	8640-399-001	6
*	Expansion Nut (After Serial D1.21180.036)	8640-442-001	6
7	Panel Assy., Front- Lower (Wht)	9989-521-003	1
7	Panel Assy., Front- Lower (SS)	9989-521-001	1
8	Panel Assy., Front- Upper (Wht)	9989-517-003	1
8	Panel Assy., Front- Upper (SS)	9989-517-001	1
*	Insulation Front Panel, half moon (top)	9277-054-001	2
*	Insulation Front Panel, half moon (bottom)	9277-054-002	2
9	Screw, FLHDCR, 10B x 1	9545-008-014	14
*	Lockwasher	8641-585-001	6
*	Spring Nut (Before Serial D1.21180.036)	8640-399-001	12
*	Expansion Nut (After Serial D1.21180.036)	8640-442-001	12
10	Strap, Hinge (Wht)	9544-069-002	2
10	Strap, Hinge (SS/Black)	9544-069-005	2
*	Screw, Hinge to Panel	9545-012-028	8
11	Screw, Door to Hinge Strap (Special Black Type)	9545-052-001	2
12	Washer, Fiber	8641-436-003	2
13	Acceptor, Coin	9021-041-001	1
*	Retainer, Coin Acceptor	9486-149-001	2
14	Screw	9545-053-002	4
*	Switch, Optical	9801-099-001	1
*	Cabinet Touch Up Paint (White)	9472-001-013	1

Cabinet Group Continued

Key	Description	T-50X2-11 Reversing	QTY
15	Escutcheon, Upper	9994-032-001	1
16	Trim, Overlay-Upper Blue	9435-039-002	1
16	Trim, Overlay-Upper Black	9435-039-001	1
17	Escutcheon, Lower	9994-033-001	1
18	Trim, Overlay-Lower Blue	9435-023-001	1
18	Trim, Overlay-Lower Black	9435-031-001	1
*	Screw, #4-40 x 3/16	9545-020-009	20
19	Nameplate Stack Dryer Express Blue	9412-167-002	1
19	Nameplate Stack Dryer Express Black	9412-167-001	1
20	Lint Drawer Assembly Blue	9866-005-001	2
20	Lint Drawer Assembly Black	9866-005-004	2
21	Overlay Trim, Lint Drwr-Blue	9435-024-001	1
21	Overlay Trim, Lint Drwr-Black	9435-032-001	1
*	Felt Seal (back of lint screen assembly)	9532-074-003	2
*	Lint Screen Assembly ONLY (no front)	9805-033-002	2
*	Replaceable Lint Screen Only	9555-057-008	2
22	Lock and Key, Lint Drawer	8650-012-004	2
*	Key 6101 only	6292-006-010	1
*	Cam, Lock	9095-043-001	2
*	Lint Screen Strap Hold Down Screws 10Bx 1/4	9545-008-001	32
23	Controls Assy, Blue	9857-198-002	1
23	Controls Assy, Black	9857-198-004	1
*	Harness, Electronic Control	9627-859-003	1
24	Lock and Key, Control	8650-012-003	1
*	Cam, Lock	9095-041-001	1
*	Key only 6324	6292-006-007	1
*	Harness, Heat Sensor	9627-855-003	1
*	Wire Nut Connector Grey	8640-276-002	4
25	Sensor Temp Control	9501-004-003	2
26	Bracket, Heat Sensor Mtg (Under Basket) w/ sensor	9501-008-001	2
*	Screw, Round Head (Mounts sensor; phillips head)	9545-045-005	2
*	Gromm.et, 3/16 ID	9209-037-002	2
*	Leg, Leveling 1/2"	8544-006-001	4
*	Wrench, Leg leveling tool	8545-061-002	1
*	Cover, Cabinet (Top)	9074-320-001	1
*	Insulation Cabinet Cover	9277-041-017	1
*	LP Kit for 50Lb Stk Dryers	9732-102-013	1
*	Stack Dryer Trunion Puller	9732-243-001	1
*	Strap - Bead Tie	9544-041-002	1
27	Vault, Coin Box	9942-038-005	1
*	Screws, Mounting-Coin Vault	9545-008-024	2
28	Coin Box Assy, Large Blue	9807-099-002	1
28	Coin Box Assy, Large Black	9807-099-004	1
*	Nut, Elastic Stop	8640-413-004	*

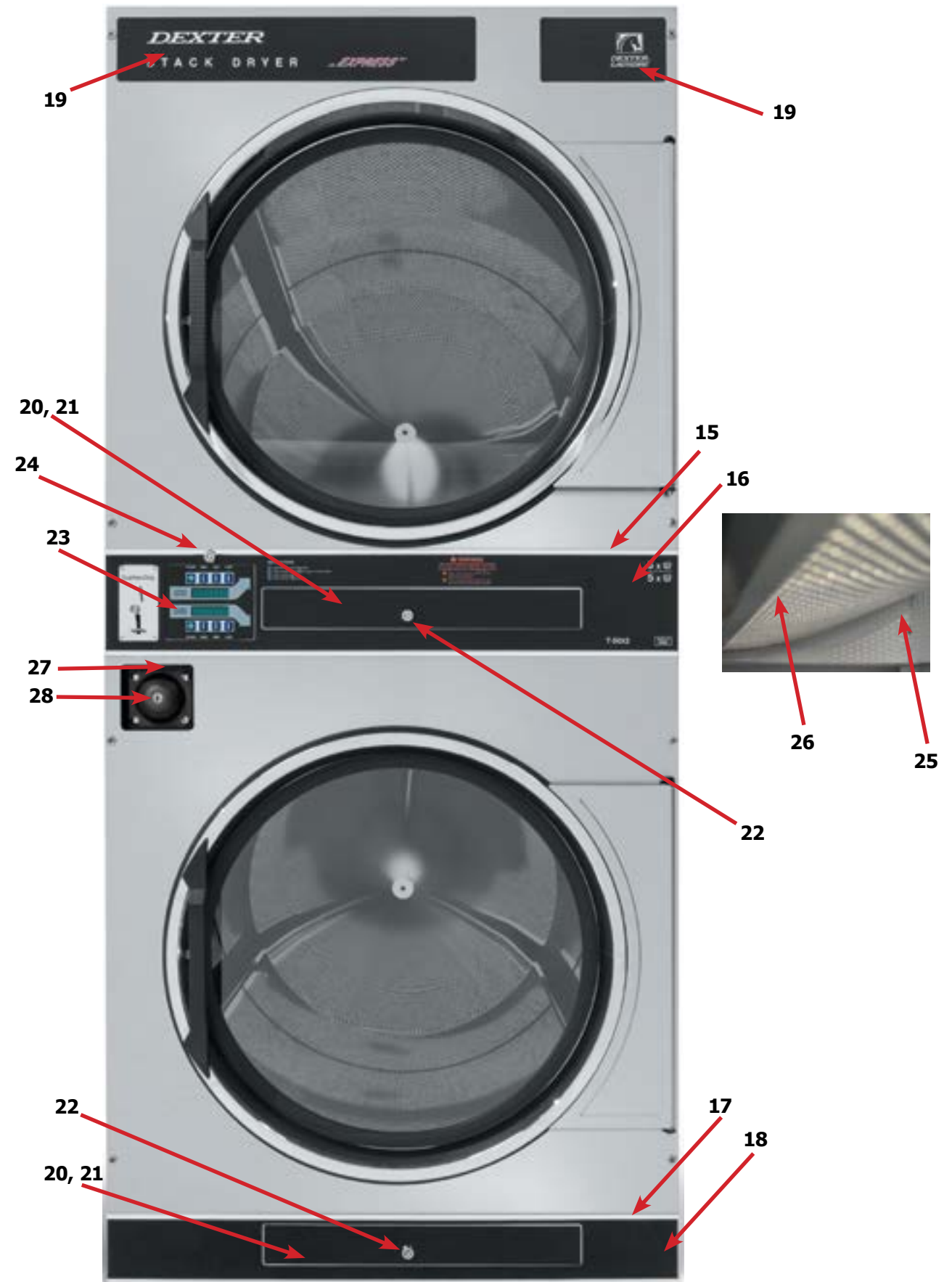

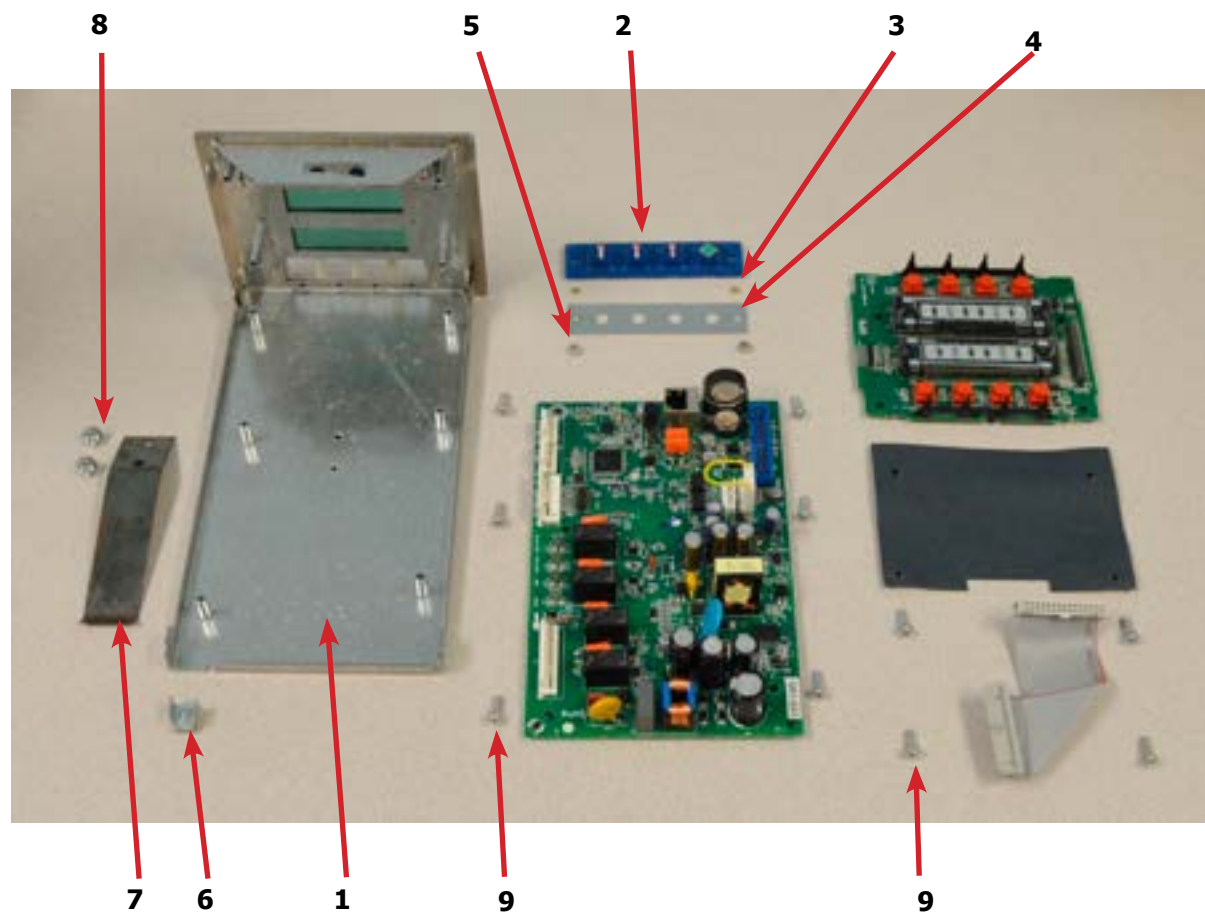

Control Parts Group

Key	Description	T-50X2-11 Reversing	QTY
*	Controls Assy, Electronic Mounted With Membrane Switch, BLU	9857-198-002	1
*	Controls Assy, Electronic Mounted With Membrane Switch, BLK	9857-198-004	1
1	Trough Assembly	9826-008-001	1
2	Button-Push, Control, Black	9035-062-002	2
2	Button-Push, Control, Blue	9035-062-001	2
3	Spacer-Metal, 4mm	9538-166-011	4
4	Retainer-Push Button	9486-158-001	2
5	Nut-Hex, Elastic stop, #4-40	8640-424-002	4
6	Terminal-Grounding clip	8652-130-038	1
7	Spring-Flat, Control	9534-365-001	1
8	Screw-Hex, #10B x 1/4	9545-008-001	2
9	Screw-Hex, #10B x 1/4	9545-044-010	10
9	Washer-External tooth, #6	8641-582-005	10
10	Overlay-Control, Coin, Black	9435-038-001	1
10	Overlay-Control, Coin, Blue	9435-038-002	1
11	Acceptor-Coin, Optical	9021-041-001	1
*	Retainer, Coin Acceptor	9486-149-001	1
12	Screw	9545-053-002	4
*	Optical Sensor, Replacement	9801-099-001	1

Sensor Assembly, Thermister

Key	Description	T-50X2-11 Reversing	QTY
*	Bracket for Heat Sensor Mounting (Under Basket) w/ sensor	9501-008-001	2
1	Bracket Assembly Thirmister	9985-188-001	2
2	gasket spacer	9206-176-000	2
3	Gromet	9209-037-002	2
4	Screw, 8B x 14	9545-045-005	2
5	Sensor-Heat, Thermister- 40K Ohm	9501-004-003	2
*	Screw-Mounting, 10AB x 3/8	9545-008-024	2

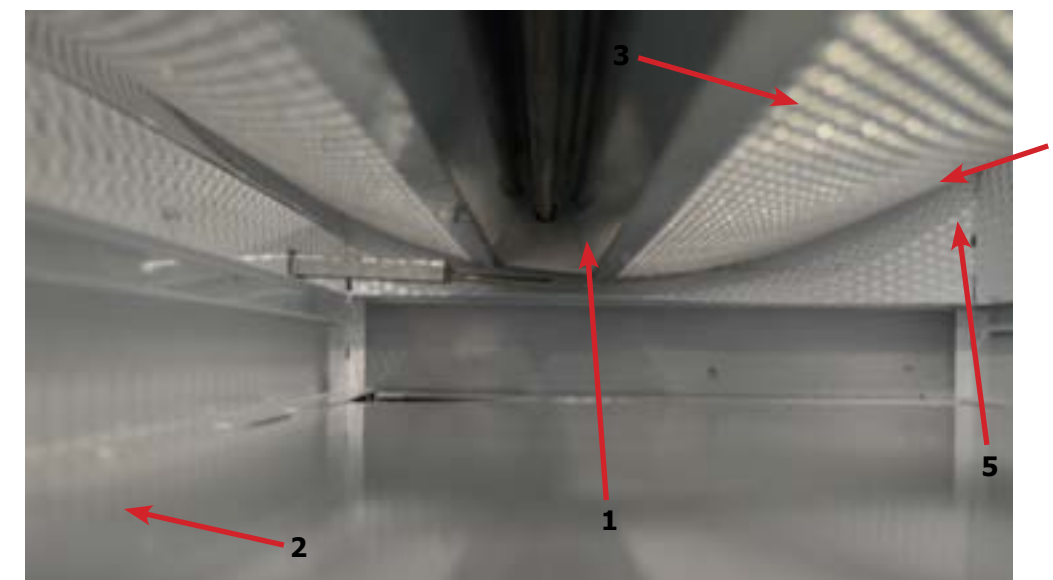

Door Switch Group

Key	Description	T-50X2-11 Reversing	QTY
1	Door Switches	9539-487-001	2



Hinge Plate Cover

Key	Description	T-50X2-11 Reversing	QTY
1	Cover-Hinge, Black	9074-340-002	2
2	Screw-TRHDCR, 10B x 3/8, Black	9545-008-010	4

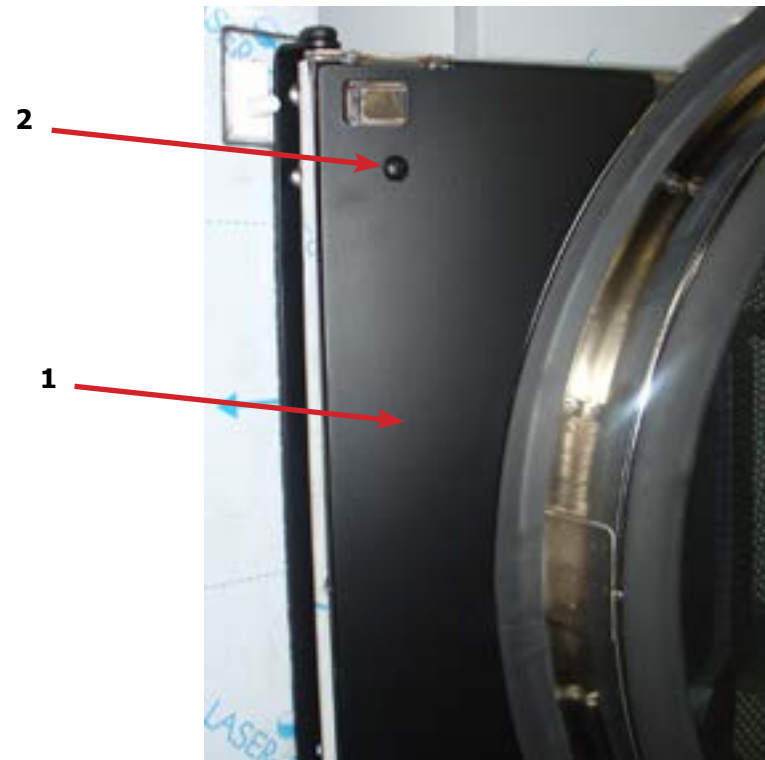

Bearing Housing Group

Key	Description	T-50X2-11 Reversing	QTY
	Bearing Housing Complete Assy (Includes bearings & Spacer)	9803-201-001	1
1	Housing, Bearing	9241-189-002	1
*	Bearing, Ball, Front	9036-159-001	1
*	Spacer, Bearing	9538-183-001	1
2	Bearing, Ball, Rear	9036-159-003	1
3	Screw-Wizlock, 1/2-13x3/4	9545-017-017	4
4	Nut, 1/2-13	8640-417-002	2
5	Screw, 1/2-13x1 1/2	9545-017-018	2
6	Nut, 1/2-13	8640-417-002	2

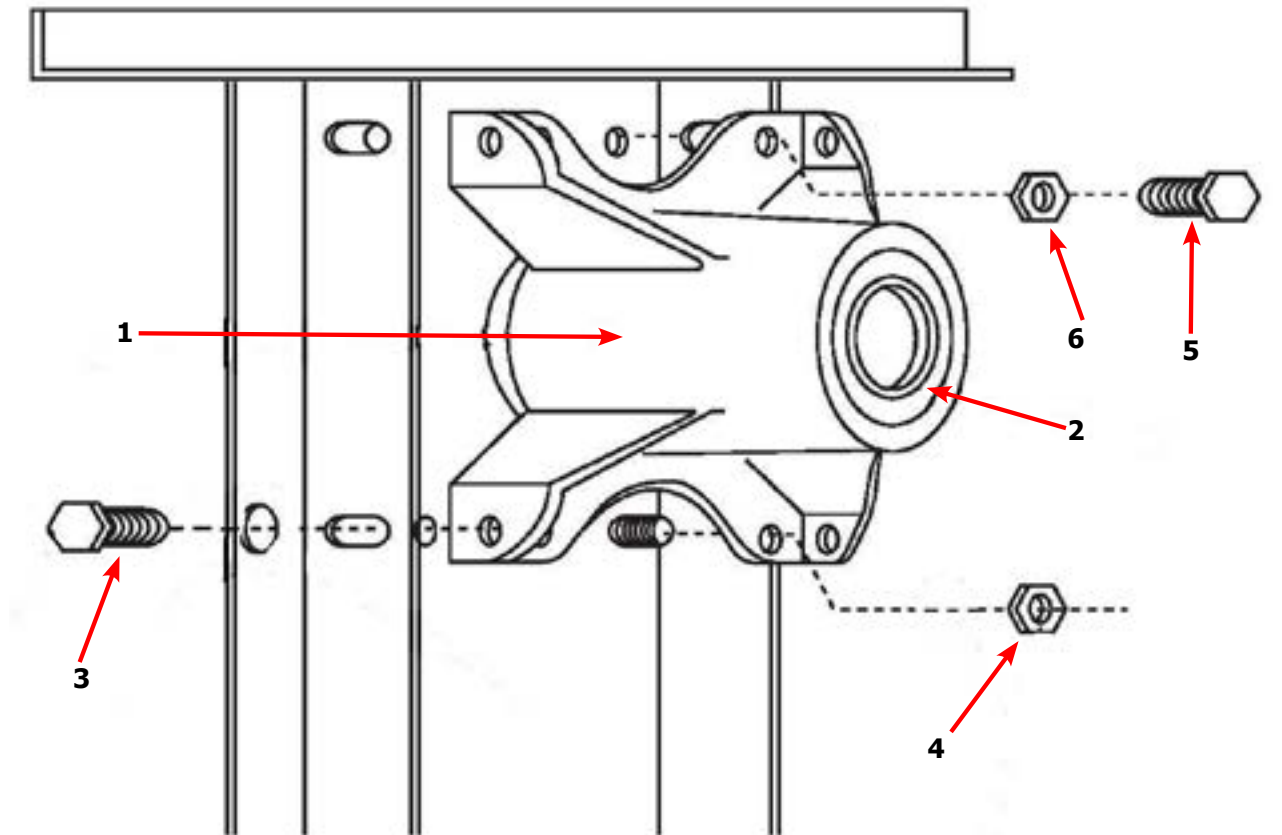

Burner Housing Group

Key	Description	T-50X2-11 Reversing	QTY
*	Housing Assembly, Burner	9803-207-001	2
1	Service Burner Plate Front	9452-730-001	2
2	Service Plate baffle Recirculation Chamber Clean Out	9452-729-001	2
*	Screw, 10B x 3/8"	9545-008-006	8
3	Screw, 10B X 1/4"	9545-008-001	16
4	Angle, Burner Support	9003-220-001	2
*	Screw, 10B x 3/8"	9545-008-006	4
5	Burner, Main	9048-020-002	4
*	Screw 10AB x 3/8"	9545-008-006	4
*	Panel, Back Burner Housing	9454-824-001	2
6	Electrode Assy, Ignition	9875-002-003	2
7	Screw, Electrode Mtg 8B x 1/4"	9545-045-001	4
8	Valve, Gas Shut Off (Optional)	9379-196-001	1
9	Control Assy, Gas (Honeywell)	9857-134-001	2
9	Control Assy, Gas (White Rodgers)	9857-192-001	2
10	Manifold, Assy	9381-012-001	2
*	Orifice, Burner-Natural #29	9425-069-021	4
*	Orifice, Burner-LP #46	9425-069-022	4
11	Bracket, Manifold	9029-175-001	4
12	Pipe Plug in end of Burner Manifold	8615-104-038	2
*	Screw, 10B x 3/8"	9545-008-006	4
13	Thermostat, Hi-Limit	9576-203-002	4
*	Spacer, Hi-Limit	9538-142-001	2
*	Screw 8B x 3/4"	9545-045-007	6
14	Cover, Hi-Limit Stat Ignitor	9074-329-001	2
15	Screw, 10B x 3/8"	9545-008-006	4
*	Thermostat, Safety Shutoff	9576-207-008	2
*	Screw, 10B x 3/8"	9545-008-006	6
16	Cover, Safety Stat	9825-062-001	2
*	Screw, 10AB x 3/8	9545-008-024	6
*	Control, Ignition Fenwall (3 trybox)	9857-182-001	2
*	Kit, LP Conversion 50Lb Stack Kit (Honeywell)	9732-102-013	1
*	Kit, LP Conversion 50Lb Stack Kit (White Rodgers)	9732-102-045	1
*	Welded One Piece Gas Pipe Assembly w/Shutoff Valve	9838-018-003	1
*	Gas Pipe Assembly Replacement Kit	9732-360-003	1
*	Gas Pipe Assembly (After Serial)	9838-023-003	1
*	Fitting - 1/2 NPT Union Adapter	8615-120-001	1
17	Heat Recirculation Duct, (From Exhaust to Burner	9973-032-001	2
*	Screw, 10B x 3/8"	9545-008-006	8

Burner Housing Group Photos

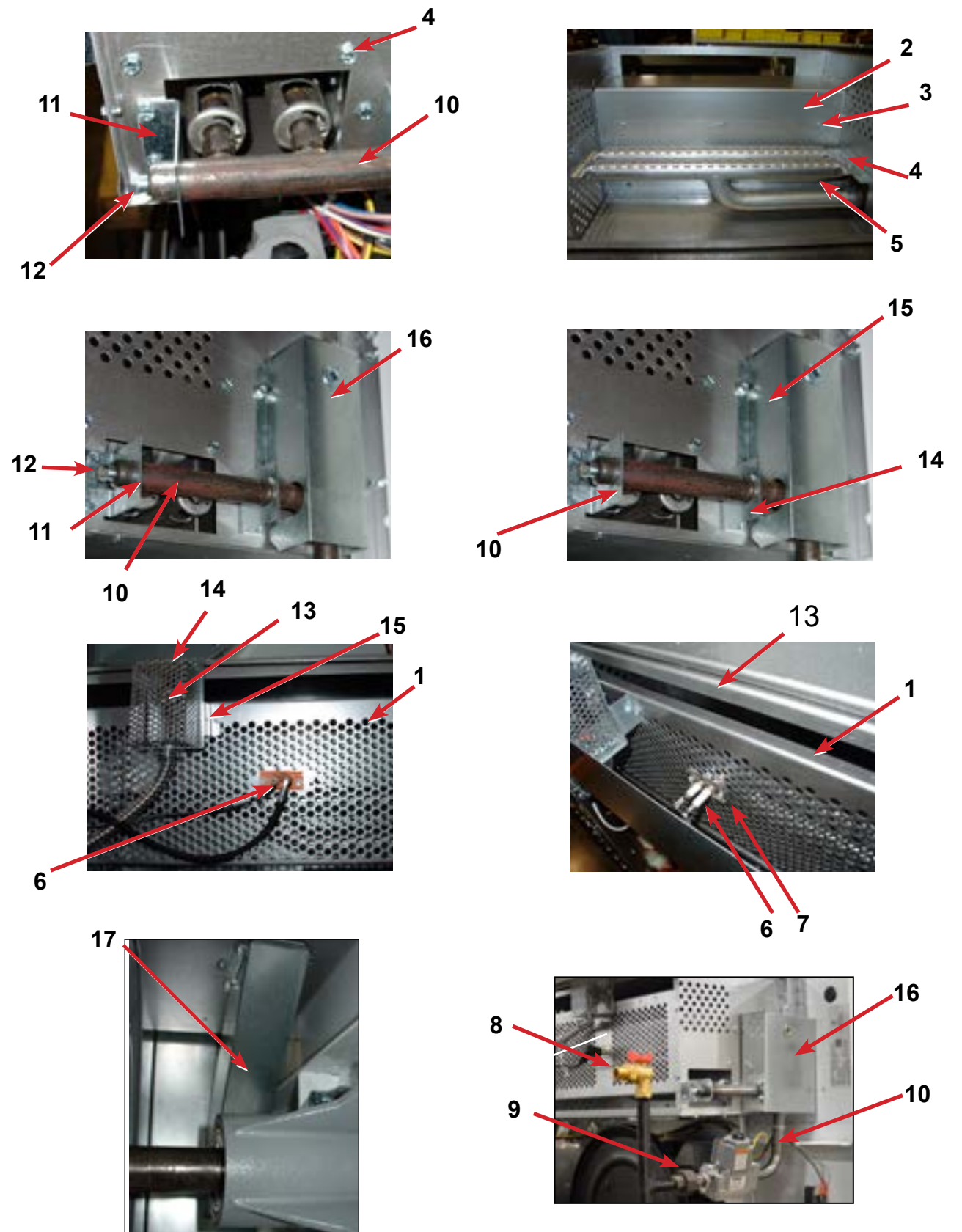

Rear View Photos

Key	Description	T-50X2-11 Reversing	QTY
*	Spacer, Tumbler pulley	9538-047-002	2
1	Pulley, Driven	9908-047-002	2
*	Tolerance Ring	9487-234-005	2
2	Washer-Flat, 1/2"	8641-581-026	2
3	Lock Washer, 1/2"	8641-582-016	2
4	Bolt, 1/2"-13 x 1" 1/4"	9545-017-009	2
5	Belt, Drive	9040-076-003	2
6	Air Flow Switch, Assembly	9801-098-001	2
7	Motor-Drive, 2Hp.	9376-319-001	2
8	Pulley-Motor, Drive	9453-169-012	2
*	Screw-Set, 5/16"-18 x 1/2"	9545-028-013	4
9	Rod-Motor Mounting	9497-222-008	2
*	Bushing, Motor Support	9053-074-002	4
10	Collar-Shaft, w/Set Screw	9076-052-002	2
11	Spring, Belt Tension	9534-319-002	2
12	Chain, Spring Tension, 15 1/2" (27 Links)	9099-012-008	2
13	Hook, "S" Hook	9248-022-002	2
14	Drive-VF, Inverter, 2Hp 230V	9375-032-010	2
15	Plate Assembly, Impeller-Blower Motor	9982-388-002	2
16	Motor, Blower	9376-311-005	2
17	Bolt-Motor Mounting, 5/16, 18 x 5/8"	9545-014-004	8
*	Nut, 5/16"-18	8640-400-003	8
*	Impeller, w/Set Screws	9278-043-001	2
18	Nut-1/4" x 20, Mounting Plate, Impeller Motor Assy.	8640-414-007	14
*	8" Slide Open Clean Out Duct (Optional)	9973-034-001	1

Rear View Photos

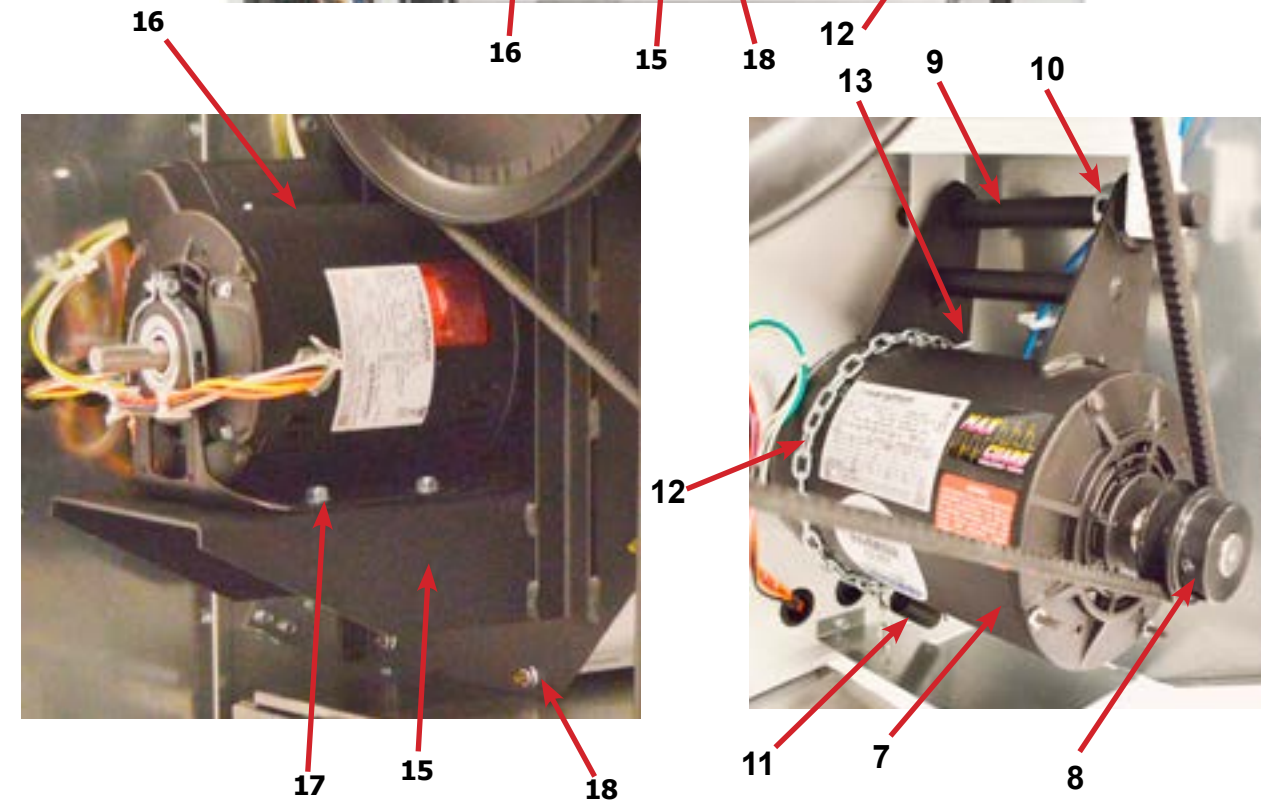
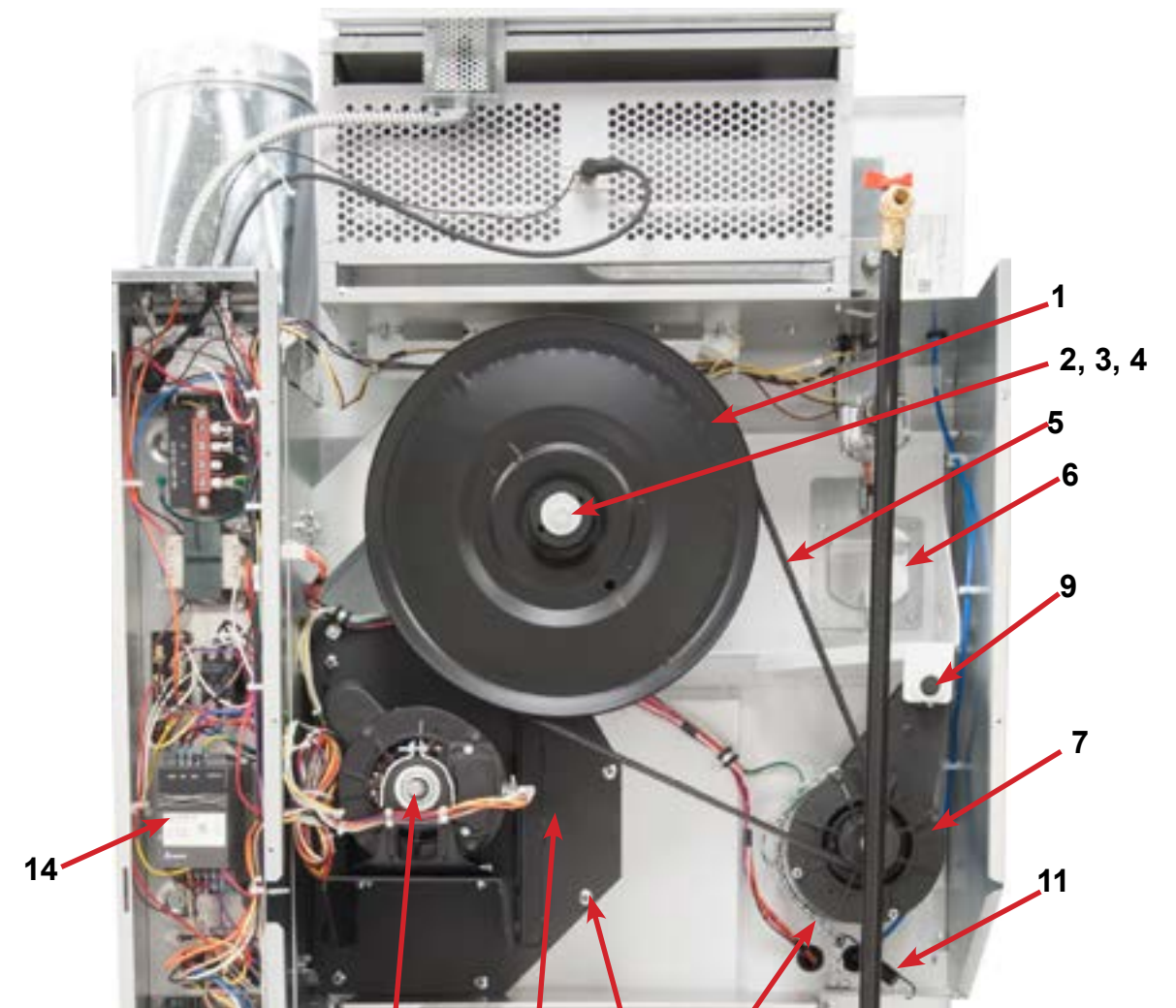

Rear Panel & Cover Group

Key	Description	T-50	QTY
1	Rear Guard Side Panel	9208-090-001	2
4	Screws 10 AB x 3/8	9545-008-024	30
5	Label - Connection Electrical	8502-649-001	1
8	Rear Guard Back Panel	9208-089-001	2
*	Screws, Guard	9545-008-004	*
10	Label Warning & Notice	8502-600-001	1
11	Label - Instructions	8502-645-001	1
12	Transition Assembly Outlet	9109-113-001	1
13	Top Cover Dryer Panel	9074-320-001	1
14	Top Burner Housing Heat Shield Inlet	9550-188-001	1
15	Top Panel Burner Housing Cover	9074-321-001	1

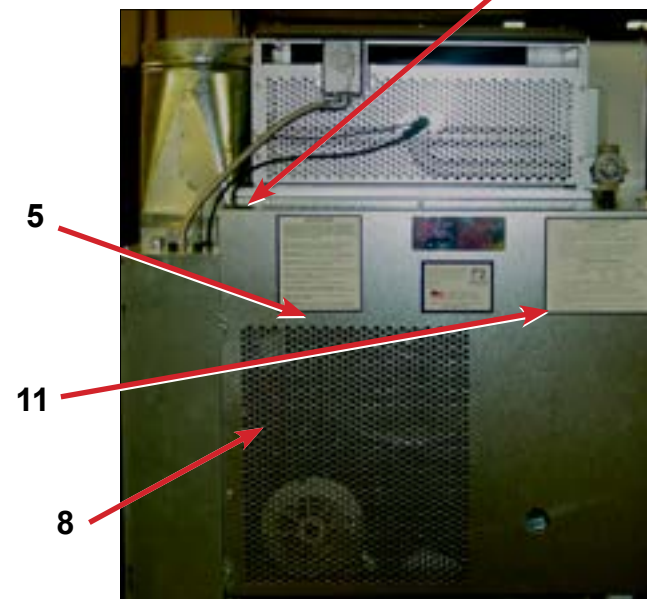
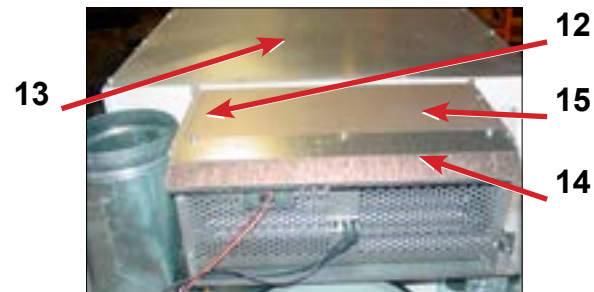
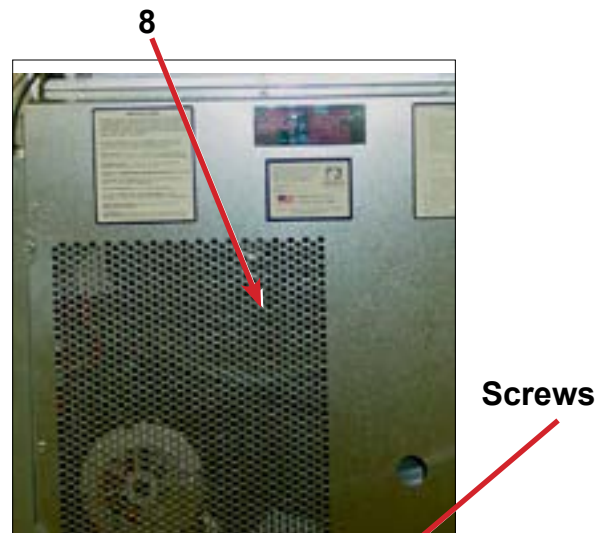

Notes

Control Assembly Group

Key	Description	T-50X2-11 Reversing	QTY
*	Control, Rear	9857-223-001	1
*	Bracket, Terminal Block Power	9029-202-001	1
1	Strip, Terminal Marker	9558-029-006	1
2	Terminal-Block, Power, 4 Pole	9897-035-001	1
3	Screw, 10AB x 3/8"	9545-008-024	1
*	Harness Assembly-Power Main Fork, Upper	9627-859-005	1
*	Harness Assembly-Power Main Fork, Lower	9627-859-006	1
4	Wire Assembly-Ground, GRN/YEL, 7"	8220-137-002	1
*	Lock Washer, Ext tooth	8641-582-006	1
5	Screw, 10-32 x 1"	9545-008-027	1
6	Transformer, 208/240/60Hz. 24/120VA	8711-013-001	1
7	Screw, 10AB x 3/8"	9545-008-024	4
8	Fuse Holder Assembly	9200-001-002	3
*	Fuse, 1.5Amp/250V-Fast Acting	8636-018-001	2
*	Fuse, 2.5Amp/250V-Fast Acting	8636-018-004	1
9	Relay, Motor, 30Amp 24VAC	5192-299-002	2
*	Screw, Phillips, 8AB x 1/2"	9545-045-012	4
10	Terminal Block, Power	9897-026-003	2
*	Screw, Phillips, 8AB x 1/2"	9545-045-012	4
11	Terminal Block Power	9897-026-002	1
*	Screw, Phillips, 8AB x 1/2"	9545-045-012	2
12	Relay-Enable, 24Vac 50/60Hz	5192-285-004	2
*	Screw, Phillips, 8AB x 3/8"	9545-045-008	4
13	Drive VFD-Inverter, 230V,	9375-032-010	2
*	VFD Cooling Fan	9189-013-001	1
*	Screw-Mounting, 10B x 1/2"	9545-008-026	8
14	Key-Pad, Display, Delta E-Drive	9150-044-001	2
15	Resister-Dynamic Breaking, 2000hm	9483-004-002	2
*	Screw, 10AB x 3/8"	9545-008-024	4
*	Wire Assembly, Violet, 8"	8220-118-003	4
*	Screw, #6-32 x 5/16"	9545-044-006	4
*	Nut, Hexkeps, #6-32	8640-411-003	4
*	Harness-Assembly, Low Voltage, Upper	9627-867-007	1
*	Harness-Assembly, Low Voltage, Upper	9627-867-008	1
16	Ignition Module	9857-182-001	2
*	Screw, 10AB x 3/4"	9545-008-018	4
17	Wire Assembly, High Voltage	9631-403-009	2
*	Door-Control Box	9108-139-001	1
*	Screw, 10AB x 3/8"	9545-008-024	3

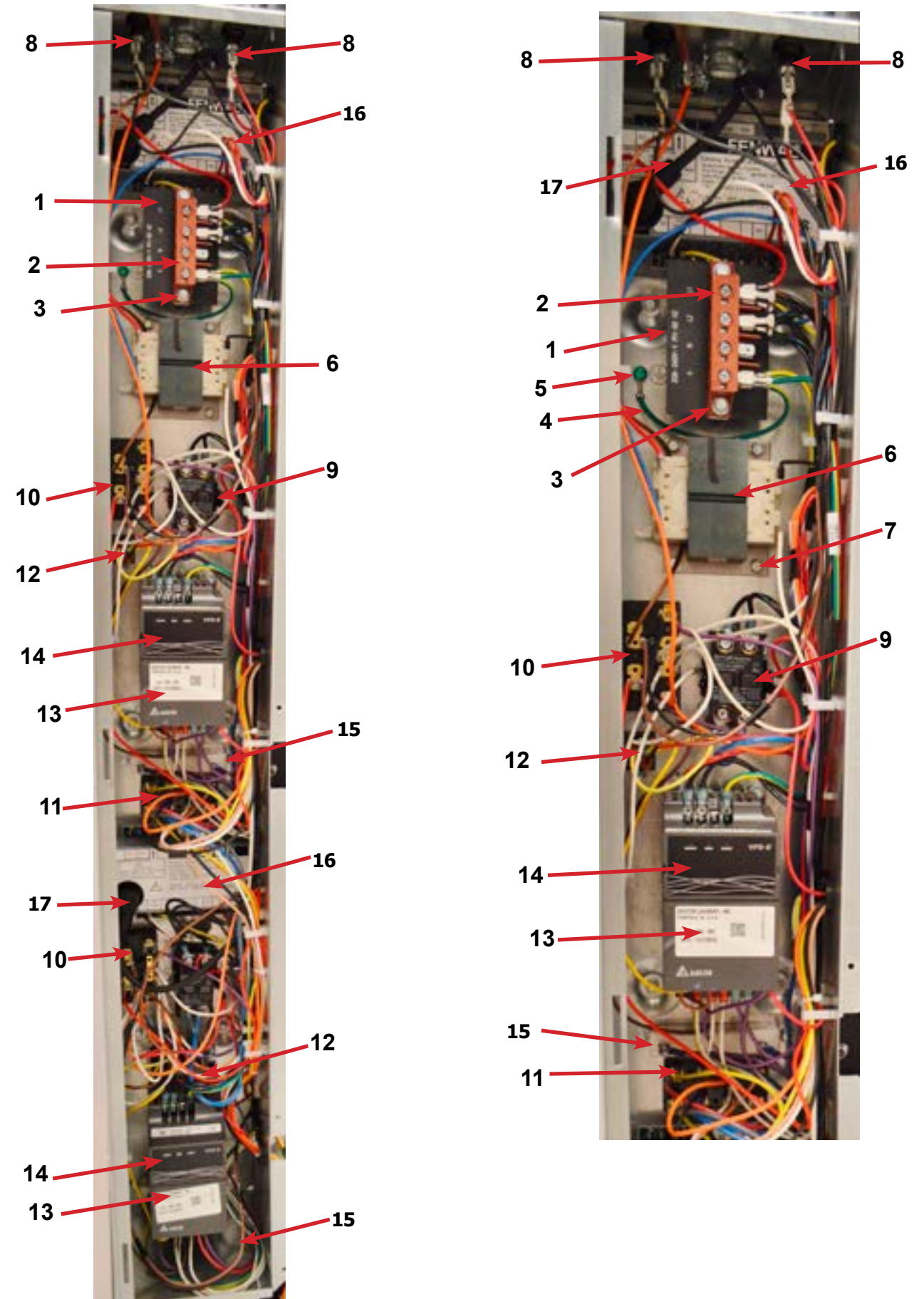

Air Flow Switch Assembly

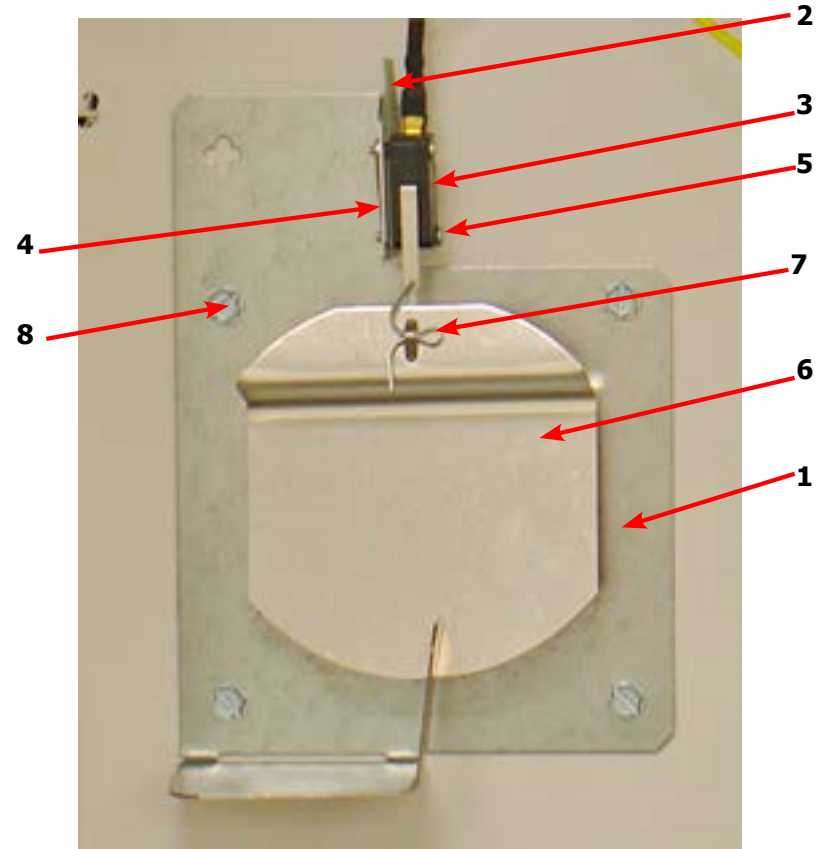

Key	Description	T-50X2-11 Reversing	QTY
*	Air Flow switch Assy	9801-098-001	2
1	Bracket-Airflow switch	9029-200-001	2
2	Shield-Switch	9550-169-003	2
3	Switch-Micro	9539-461-009	2
4	Nut-Twin, 4-40	8640-401-001	2
5	Screw-.625, 4-40	9545-020-001	2
6	Actuator-Air Flow Switch	9008-007-001	2
7	Pin-Cotter, .09375x.75	9451-169-002	2
8	Screw, 10Bx1/4	9545-008-001	8
*	Harness Assembly, Overtemp/Airflow	9627-861-001	1

Coin Acceptor

Key	Description	T-50X2-11 Reversing	QTY
1	Coin Acceptor, Optical	9021-041-001	1
2	Sensor-Optical, Replacement	9801-099-001	1
3	Screw, Height Bar, 3mm	9454-039-002	2
*	Retainer, Coin Acceptor	9486-136-001	1
*	Screw, Torx T-10, 4BX5/8 ss	9545-053-002	4

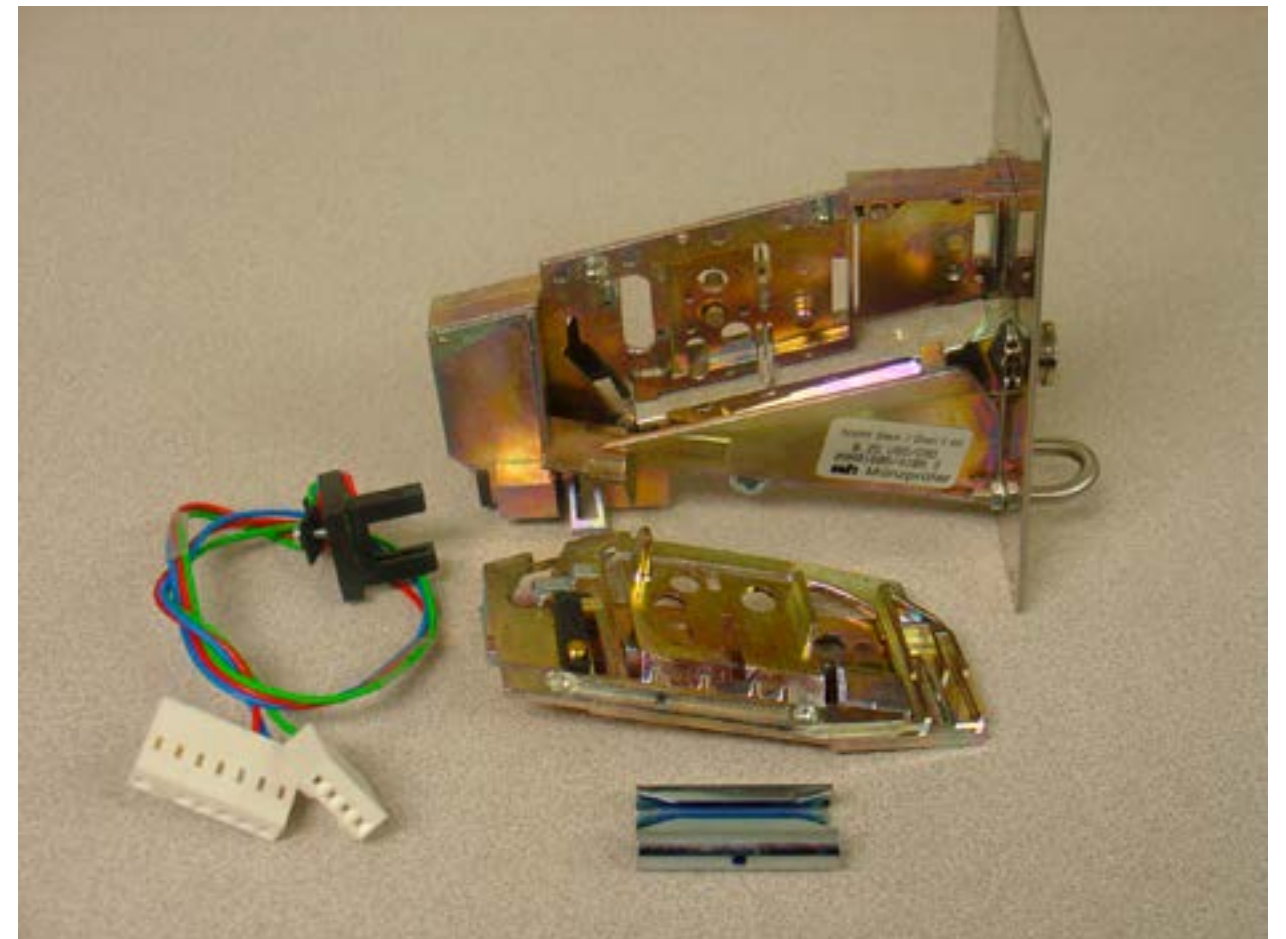

Wiring Schematic for DC50x2

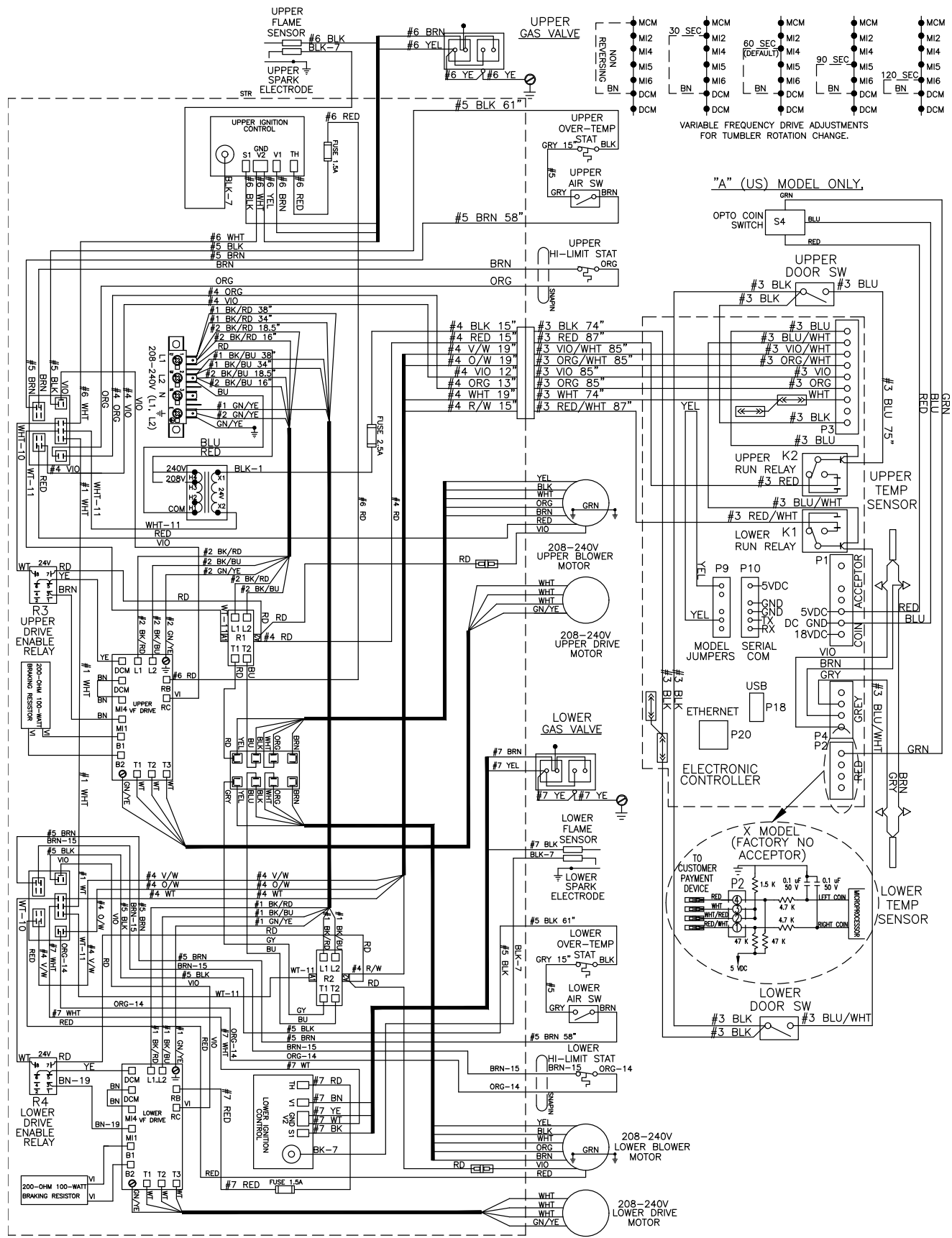

9506-790-001B WIRING DIAGRAM DC50X2NC-11EC_R

Wiring Diagram for DC50x2

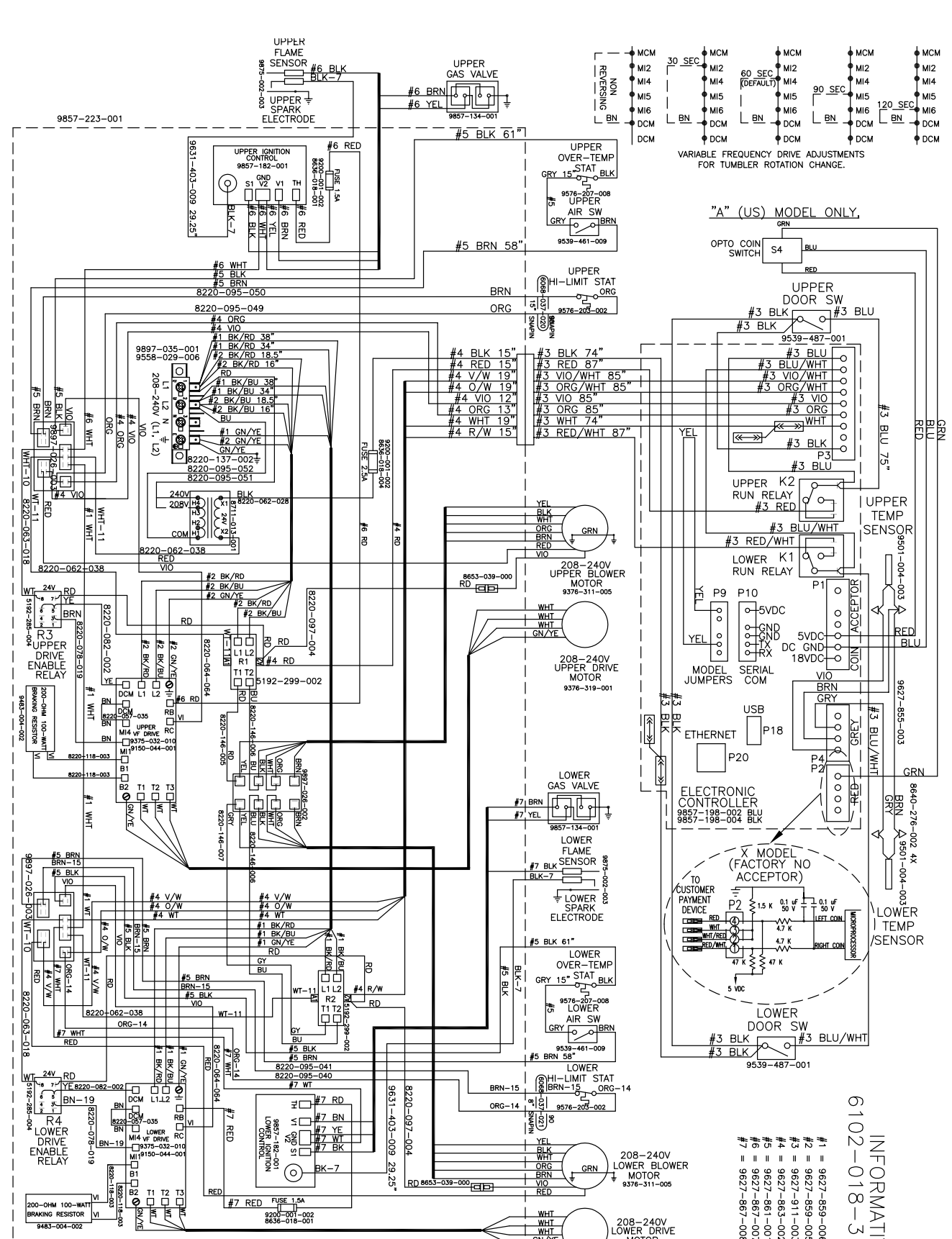

9506-790-001A WIRING DIAGRAM DC50X2NC-11EC_R

INFORMATIVE
6102-018-315B

Rear View Photos

Key	Description	T-50X2-49 Reversing	QTY
*	Spacer, Tumbler pulley	9538-047-002	2
1	Pulley, Driven	9908-047-002	2
*	Tolerance Ring	9487-234-005	2
2	Washer-Flat, 1/2"	8641-581-026	2
3	Lock Washer, 1/2"	8641-582-016	2
4	Bolt, 1/2"-13 x 1" 1/4"	9545-017-009	2
5	Belt, Drive	9040-076-003	2
6	Air Flow Switch, Assembly	9801-098-001	2
7	Motor-Drive, 2Hp.	9376-319-001	2
8	Pulley-Motor, Drive	9453-169-012	2
*	Screw-Set, 5/16"-18 x 1/2"	9545-028-013	4
9	Rod-Motor Mounting	9497-222-008	2
*	Bushing, Motor Support	9053-074-002	4
10	Collar-Shaft, w/Set Screw	9076-052-002	2
11	Spring, Belt Tension	9534-319-002	2
12	Chain, Spring Tension, 15 1/2" (27 Links)	9099-012-008	2
13	Hook, "S" Hook	9248-022-002	2
14	Drive-VF, Inverter, 2Hp 230V	9375-032-023	1
15	Plate Assembly, Impeller-Blower Motor	9982-388-002	2
16	Motor, Blower, 50HZ.	9376-311-004	2
17	Bolt-Motor Mounting, 5/16, 18 x 5/8"	9545-014-004	8
*	Nut, 5/16"-18	8640-400-003	8
*	Impeller, w/Set Screws	9278-043-001	2
18	Nut-1/4" x 20, Mounting Plate, Impeller Motor Assy.	8640-414-007	14

Rear View Photos

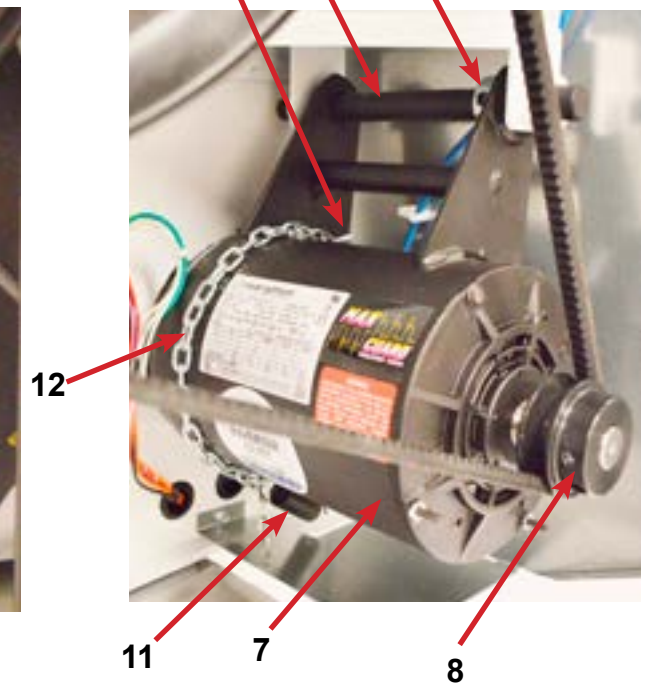
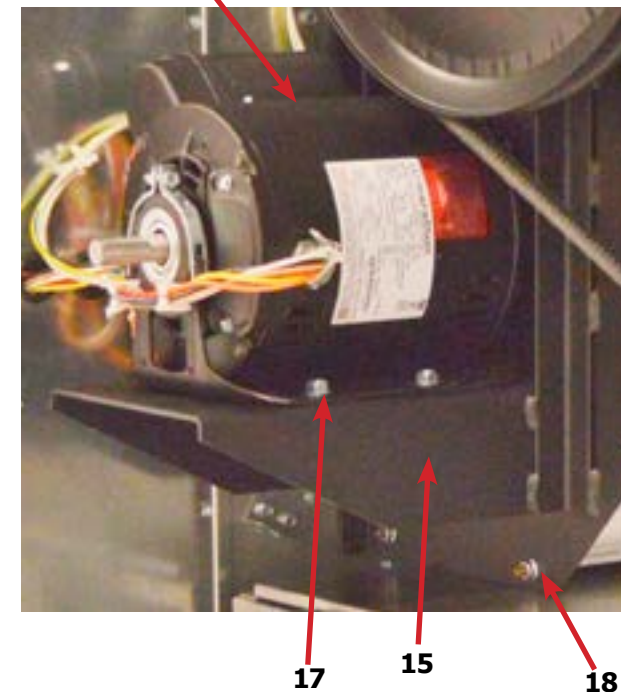
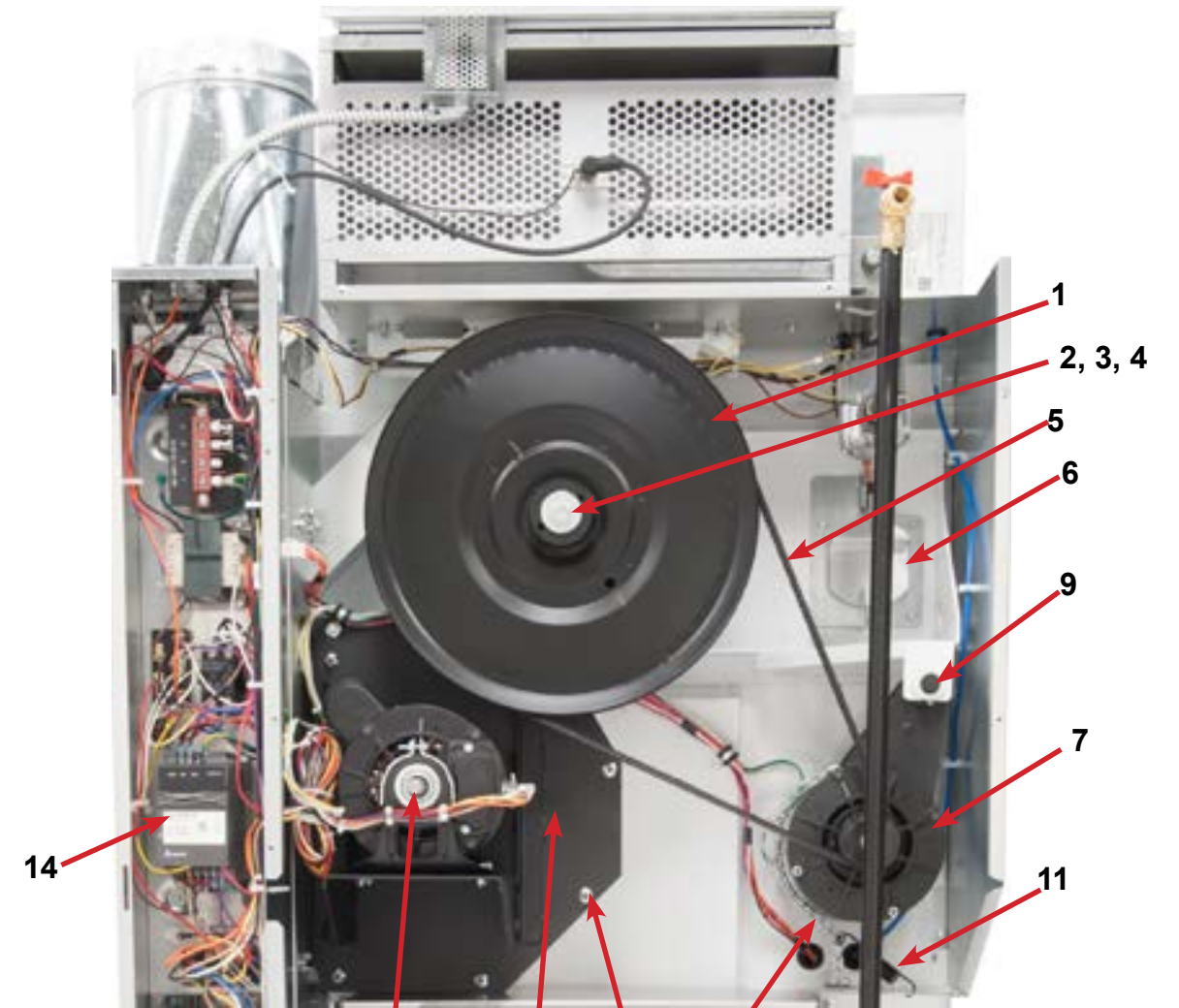

Electrical Components



Key	Description	T-50X2-49 Reversing	QTY
1	Transformer, 200/230-24 VAC, 50/60HZ	8711-004-004	1
*	Strip-Marker, Terminal	9558-029-004	1

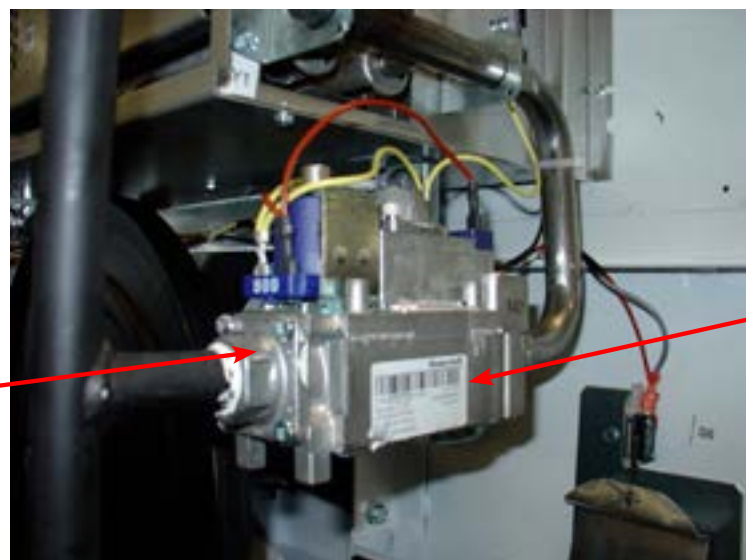

Key	Description	T-50X2-49 Reversing	QTY
1	Control Assembly, Gas Valve	9857-132-004	2
2	Kit-Honeywell VR86, Valve Flange assy	9732-162-001	4
*	Orifice, Main Burner, #30	9425-069-002	4

Air Flow Switch Assembly

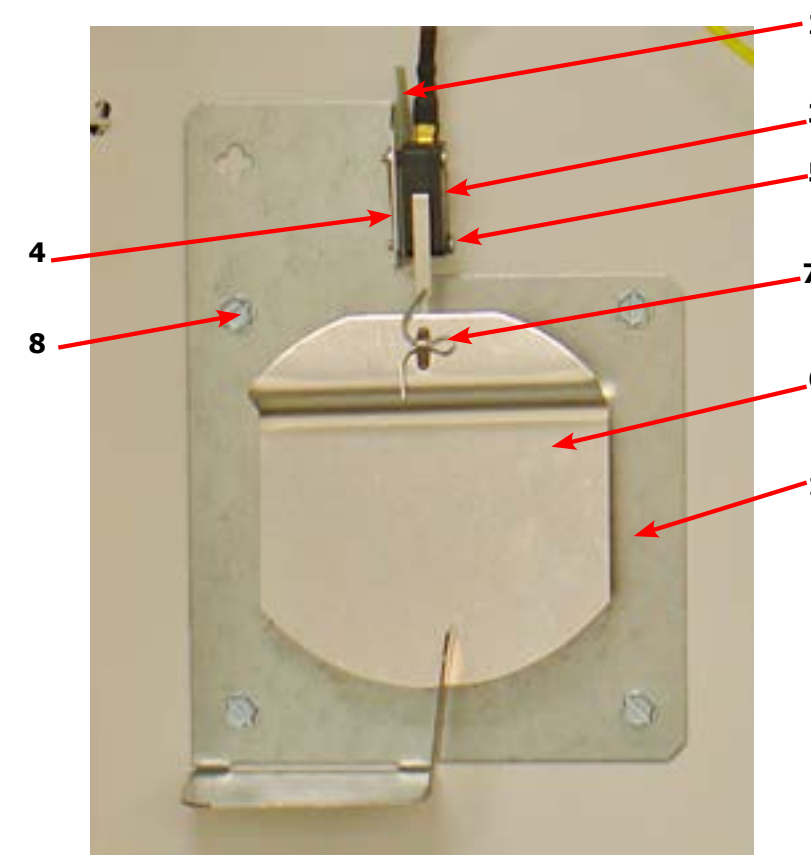

Key	Description	T-50X2-49 Reversing	QTY
*	Air Flow switch Assy	9801-098-002	2
1	Bracket-Airflow switch	9029-200-002	2
2	Shield-Switch	9550-169-003	2
3	Switch-Micro	9539-461-009	2
4	Nut-Twin, 4-40	8640-401-001	2
5	Screw-.625, 4-40	9545-020-001	2
6	Actuator-Air Flow Switch	9008-007-001	2
7	Pin-Cotter, .09375x.75	9451-169-002	2
8	Screw, 10Bx1/4	9545-008-001	8
*	Harness Assembly, Overtmp/Airflow	9627-861-001	1

Wiring Schematic for DC50x2 -49

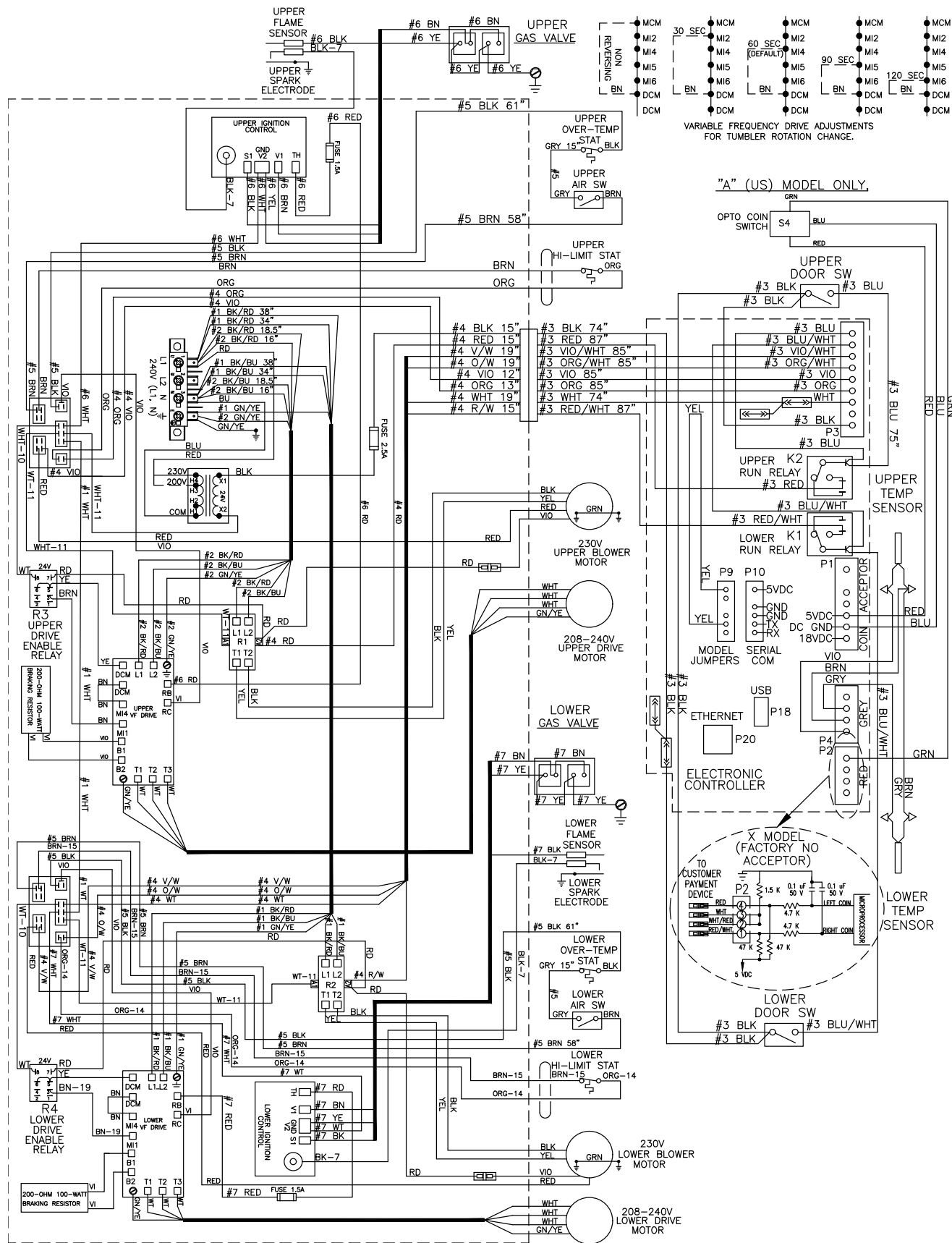

9506-804-001PR WIRING DIAGRAM DC50X2NC-49_C_R

Wiring Diagram for DC50x2 -49

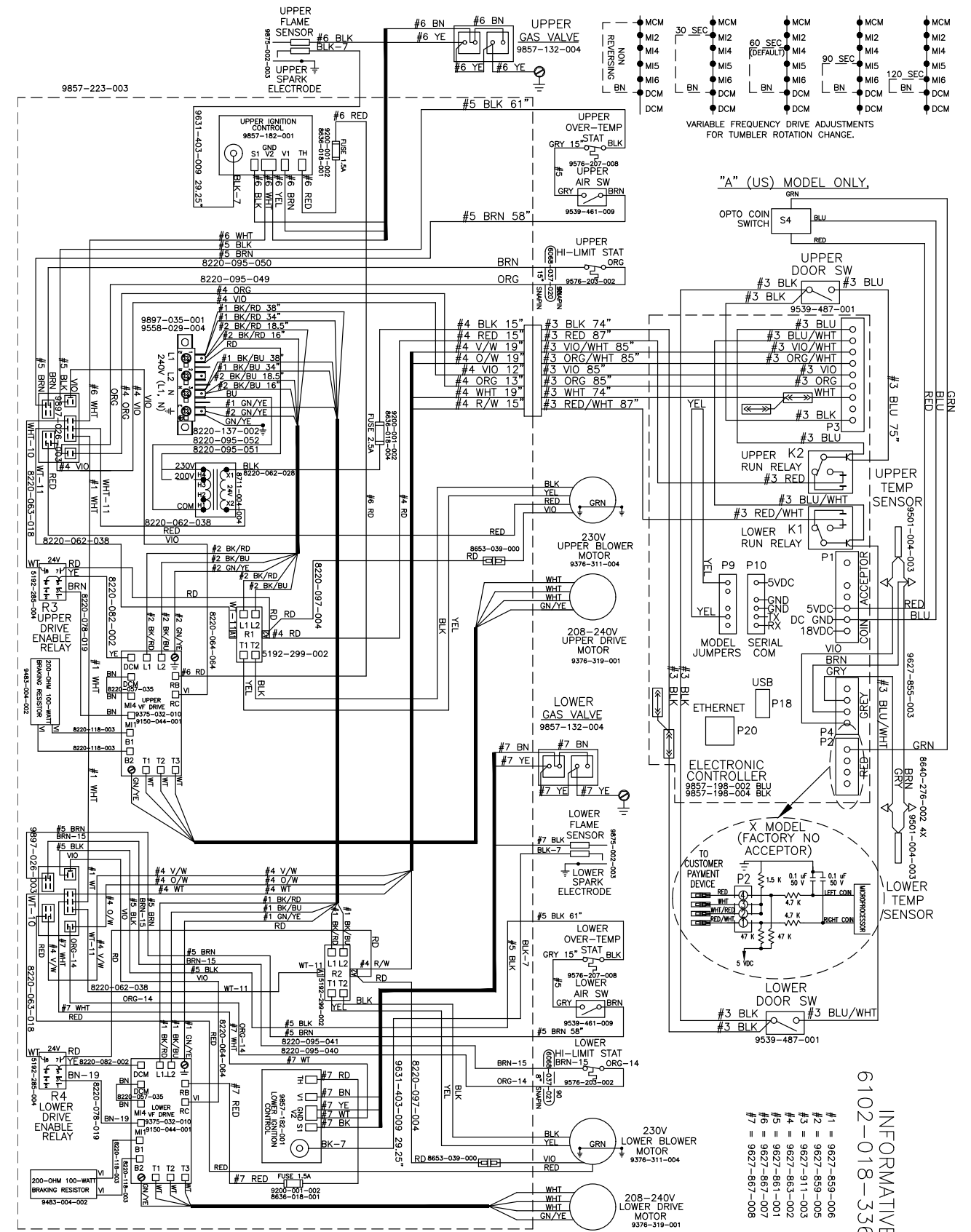

9506-804-001PR WIRING DIAGRAM DC50X2NC-49_C_R

IMPORTANT: RETAIN THIS ELECTRICAL DIAGRAM FOR SERVICE.

INFORMATIVE
6102-018-336PR

Preventative Maintenance

Daily

- Step 1:** Clean the lint screen free of lint and other debris. Use a soft brush and Hot water if necessary.
- Step 2:** Check the lint screen for tears. Replace if necessary.
- Step 3:** Clean lint from the lint screen compartment.
- Step 4:** Inspect felt seal on lint screen assembly, replace if needed.

Monthly

- Step 1:** Remove lint accumulation from the end bells of the motor.
- Step 2:** Remove lint accumulation from front control area.
- Step 3:** Remove lint and dirt accumulation from the top of the dryer and all areas above, below, and around the burners and burner housing. Failure to keep this portion of the dryer clean can lead to a build-up of lint creating a fire hazard.
- Step 4:** Remove and clean coin acceptors. (Vended Models Only)

Quarterly

- Step 1:** Check the belts for looseness, wear, or fraying.
- Step 2:** Inspect the gasket of the door glass for excessive wear.
- Step 3:** Check tightness of all fasteners holding parts to support channel.
- Step 4:** Check tightness of all set screws.
- Step 5:** Remove the air flow switch assembly and check the tumbler thru-bolts for tightness.
- Step 6:** Apply a few drops of oil to pivot pins and the tension arms where in contact with each other.

Semi-Annually

- Step 1:** Remove and clean the main burners.
- Step 2:** Remove all orifices and examine for dirt and hole obstruction.
- Step 3:** Remove all lint accumulation. Remove the front panel and the lint screen housing and remove lint accumulation.

Annually

- Step 1:** Check the intermediate pulley bearings for wear.
- Step 2:** Check and remove any lint accumulation from the exhaust system including recirculation chambers if applicable.
- Step 3:** Grease the bearings and the shaft of the intermediate pulley. Use an Alemite grease gun and Molykote BR2-S grease. (Where applicable)