



DEXTER[®]
LAUNDRY





**USE THE BLUE TABS LOCATED ON THE
RIGHT AND LEFT SIDES OF THE FOLLOWING
DOCUMENT TO ADVANCE TO EACH SECTION.**



Dexter O-Series DN0120 Reversing On Premise Dryer

Parts & Service Manual

Equipment Safety Warnings Symbols and Terminology Used in this Equipment

⚠ DANGER	Indicates an imminently hazardous situation, which if not avoided, will result in death or serious injury.
⚠ WARNING	Indicates a potentially hazardous situation, which if not avoided could result in death or serious injury.
⚠ CAUTION	Indicates a potentially hazardous situation which, if not avoided, may result in minor or moderate injury. It may also be used to alert against unsafe practices. Minor burns, pinch points that result in bruises and minor chemical irritation.
NOTICE	Indicates information or a company policy that relates directly or indirectly to the safety of personnel or protection of property.
	This is the user caution symbol. It indicates a condition where damage to the equipment resulting in injury to the operator could occur if operational procedures are not followed. TO REDUCE THE RISK OF DAMAGE OR INJURY, refer to accompanying documents; follow all steps or procedures as instructed.
	This is the electrical hazard symbol. It indicates that there are DANGEROUS HIGH VOLTAGES PRESENT inside the enclosure of this product. TO REDUCE THE RISK OF FIRE OR ELECTRIC SHOCK, do not attempt to open the enclosure or gain access to areas where you are not instructed to do so. REFER SERVICING TO QUALIFIED SERVICE PERSONNEL ONLY
	Caution! There are sharp edges on various sheet metal parts internal to the enclosure. Use safety consciousness when placing or moving your hands while working in the interior of this equipment.
	Caution! To reduce the risk of damage to the Water Inlet Valve, do not supply inlet water with a temperature that exceeds 70° C. Caution! To reduce the risk of fire or explosion, do not operate this equipment in any hazardous classified (ATEX) environment.

Equipment Safety Warnings Symbols and Terminology Used in this Equipment



Warning! Do not operate equipment if door glass is damaged in any way.



Warning! Keep clear of rotating parts.



Prohibited! Do not enter this equipment or space.



Prohibited! Do not step or stand on this equipment.

Prohibited! Do not operate without all guards and covers in place.









Prohibited! Do not operate without all guards and covers in place.



Prohibited! Do not wash or Dry clothing impregnated with flammable liquids (petrochemical).



Prohibited! Do not allow children to play in or around equipment.

	DANGER Indicates an imminently hazardous situation, which if not avoided, <u>will result</u> in death or serious injury.
	WARNING Indicates a potentially hazardous situation, which if not avoided <u>could result</u> in death or serious injury.
	CAUTION Indicates a potentially hazardous situation which, if not avoided, <u>may result</u> in minor or moderate injury. It may also be used to alert against unsafe practices. Minor burns, pinch points that result in bruises and minor chemical irritation.
	NOTICE Indicates information or a company policy that relates directly or indirectly to the safety of personnel or protection of property.
	This is the user caution symbol. It indicates a condition where damage to the equipment resulting in injury to the operator could occur if operational procedures are not followed. TO REDUCE THE RISK OF DAMAGE OR INJURY, refer to accompanying documents; follow all steps or procedures as instructed.
	This is the electrical hazard symbol. It indicates that there are DANGEROUS HIGH VOLTAGES PRESENT inside the enclosure of this product. TO REDUCE THE RISK OF FIRE OR ELECTRIC SHOCK, do not attempt to open the enclosure or gain access to areas where you are not instructed to do so. REFER SERVICING TO QUALIFIED SERVICE PERSONNEL ONLY
	Caution! To reduce the risk of fire or explosion, do not operate this equipment in any hazardous classified (ATEX) environment.



WARNING

	<ul style="list-style-type: none"> • All washers and Dryers must be installed in accordance to all applicable electrical, plumbing and all other local codes. • These installation and operation instructions are for use by qualified personnel only. To avoid injury and electrical shock, do not perform any servicing other than that contained in the installation and operation instructions, unless qualified.
	Do not install washers or Dryers in an explosive atmosphere.
	<ul style="list-style-type: none"> • Care must be stressed with all foundation work to ensure a stable unit installation, eliminating possibilities of excessive vibration. • Foundation must be level within 13 mm to ensure proper washer operation.
	Do not operate Dryer if door glass is damaged in any way.
	Do not wash or Dry clothing impregnated with flammable liquids (petrochemical).



WARNING





 	Children should be supervised to ensure they do not operate or play in or around equipment.
	Keep all panels in place to protect against electrical shock and injury and add rigidity to washer.

This appliance is not intended for use by persons (including children) with reduced physical, sensory or mental capabilities, or lack of experience and knowledge, unless they have been given supervision or instruction concerning use of the appliance by a person responsible for their safety.

A washer should not be allowed to operate if any of the following occur:

- Excessive high water level.
- Machine is not connected to a properly earthed circuit.
- Door does not remain securely locked during the entire cycle.
- Vibration or shaking from an inadequate mounting or foundation

	Warning! Do not operate equipment if door glass is damaged in any way.
	Warning! Keep clear of rotating parts.
	Prohibited! Do not enter this equipment or space.
	Prohibited! Do not step or stand on this equipment.
	Prohibited! Do not operate without all guards and covers in place.
	Prohibited! Do not operate without all guards and covers in place.
	Prohibited! Do not wash or Dry clothing impregnated with flammable liquids (petrochemical).
	Prohibited! Do not allow children to play in or around equipment.

	Prohibited! Do not attempt to open, touch, or proceed before referring to the manual or unless qualified.
	Mandatory! Read all supporting documentation before operating or maintaining equipment.
	Mandatory! Disconnect power before servicing equipment.
	Mandatory! Lock out and tag out before servicing this equipment.
	Mandatory! Children should be supervised to ensure they do not operate equipment.

Section 1:

Dryer

Specifications and Mounting

Machine Specifications: 120 Lb.

Dimensions / Capacity

Dry Weight Capacity - lb (kg)	120 lb	(54.4 kg)
Cabinet Height - in (cm)	85.3125"	(216.7 cm)
Cabinet Width - in (cm)	46.75"	(188.7 cm)
Overall Depth - in (cm)	60.1875"	(152.9 cm)
Door Opening - in (cm)	25.625"	(65.1 cm)
Cylinder Diameter - in (cm)	43"	(109.2 cm)
Cylinder Depth - in (cm)	43"	(109.2 cm)
Cylinder Volume - cu.ft. (liters)	36.1 cu.ft.	(1022.24 l)
Tumbler Speed	36.5 RPM	

Airflow - cfm (M3/min)

60Hz W/12" Outlet	1450 cfm	(41.1 M3/min)
60Hz W/10" Outlet	1250 cfm	(35.4 M3/min)
50Hz W/10" Outlet	1000 cfm	(28.3 M3/min)
Lint Screen Area	862 sq.in.	(5561 sq.cm)
Net Weight - lb (kg)	1075 lbs	(487.6 kg)

Shipping Dimensions:

Shipping Weight	1122 lbs	(508.9 kg)
Height - in (cm)	88.375"	(224.5 cm)
Width - in (cm)	48.25"	(112.6 cm)
Depth - in (cm)	68.5"	(174 cm)

BTU's / Circuit Breaker / Running Amps / Wire Size

Gas Models

60Hz	320,000 BTU/hr	(93.8 kW)
50Hz	300,000 BTU/hr	(87.9 kW)
Gas Supply Connection	0.75"	(19.1 mm)
Natural Gas Supply - (water column) Manifold	5 - 8"	(12.7 - 20.3 cm)
LP Gas Supply - (water column) Manifold	3.5" Max	(8.9 cm)
	11.5 - 13.5"	(29.2 - 34.3 cm)
	11"	(27.9 cm)

Gas Models

-11 (208-240/60/1 - 2 wire + ground)	20 amp / 15 amp / #12
-10 (120/60/1 - 2 wire + ground)	20 amp / 15 amp / #12
-39 (230/50/1 - 2 wire + ground)	20 amp / 9.8 amp / #12

Installation Recommendations

Clearance Behind Machines	18"	(45.7 cm)
Make-up Air Req. (per dryer)	2.25 sq.ft.	(2090 sq.cm)
Exhaust Size - in (cm)	10 or 12"	(20.3 cm or 30.5cm)

Machine Dimensions Front View

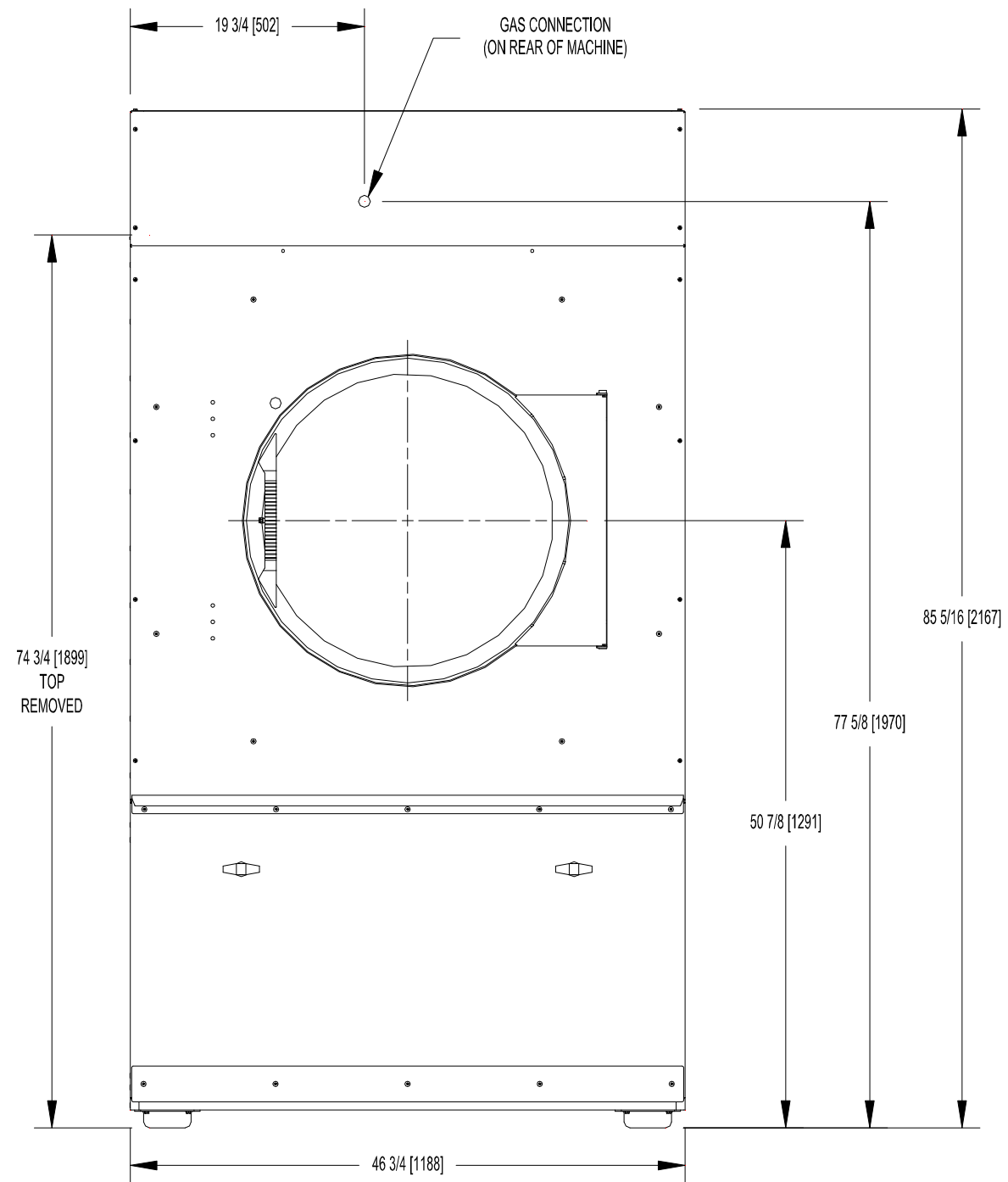

Machine Dimensions: 120Lb

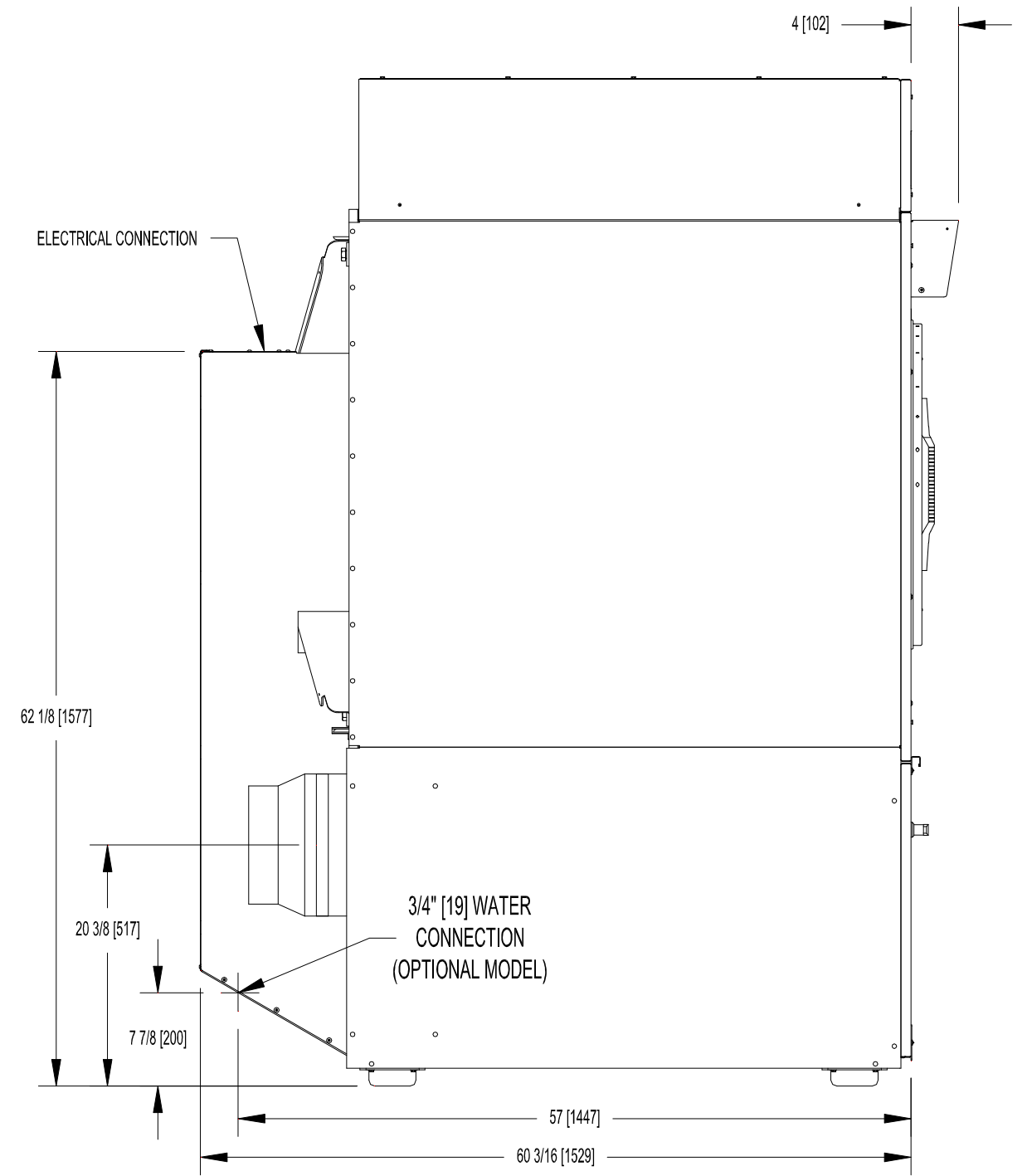

Section 2: Dryer Installation

Dryer Installation

All commercial dryer installations must conform with local codes or, in the absence of local codes, with the latest edition of the National Fuel Gas Code ANSI Z223.1A. Canadian installations must comply with current Standard CAN/CGA-B149 (.1 or .2) Installation Code for Gas Burning Appliances or Equipment, and local codes if applicable. Australian installations must meet installation requirements and pipe sizing requirements of AS/NZA 5601. The appliance, when installed, must be electrically grounded in accordance with the latest edition of the National Electrical Code, ANSI/NFPA70, or, when installed in Canada, with Standard CSA C22.1 Canadian Electrical Code Part 1.

To connect the dryer to the supply piping, use a listed connector in compliance with the Standard for Connectors for Gas Appliances, ANSI Z21.24 • CSA 6.10.

Installation Clearances:

This unit may be installed at the following alcove clearances. (millimeters)

- 1. Left side-** 0"
- 2. Right side-** 0" *
- 3. Back-** 18" (457) (Certified for 1" (25) clearance; however, 18" (457) clearance is necessary behind the belt guard to allow servicing and maintenance.)
- 4. Front-** 48" (1220) (to allow use of dryer)
- 5. Top-** Refer to figure labelled "Vertical Clearance Dimensions". Certification allows 0" clearance at the top 1" (25) back from the front. However, a 1/4" (6) clearance is required to allow opening the upper service door. A 10" (254) clearance is required from the top at all other points.
- 6. Floor-** This unit may be installed upon a combustible floor.
*Units may be installed in direct contact with an adjacent dryer, providing allowance is made for opening upper and lower service doors. Do not obstruct the flow of combustion and ventilation air. Maintain minimum of 1" (25) clearance between duct and combustible material.

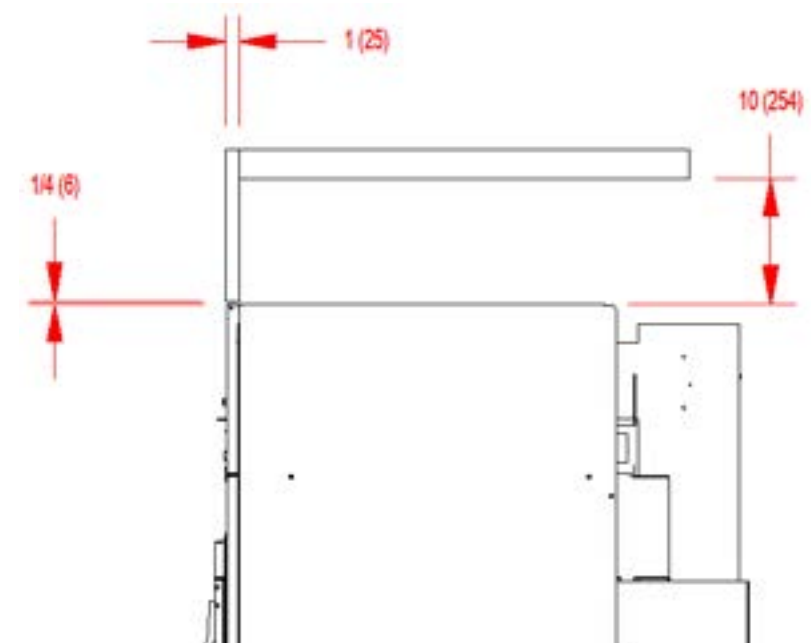

VERTICAL CLEARANCE DIMENSIONS - ALL (30/50/80/120)

MAKE-UP AIR

Adequate make-up air must be supplied to replace air exhausted by dryers on all types of installations. Refer to specifications for the minimum amount of make-up air opening to outside for each dryer. This is a net requirement of effective area. Screens, grills or louvers, which will restrict the flow of air, must be considered. Consult the supplier to determine the free area equivalent for the grill being used. The source of make-up air should be located sufficiently away from the dryers to allow an even airflow to the air intakes of all dryers. Multiple openings should be provided.

The sources of all make-up air and room ventilation air movement to all dryers must be located away from any dry cleaners. This is necessary so that solvent vapors will not be drawn into the dryer inlet ducts. Dry cleaner solvent vapors will decompose in contact with open flame such as the gas flame present in clothes dryers. The decomposition products are highly corrosive and will cause damage to the dryer(s) ducts and clothes loads

ELECTRICAL REQUIREMENTS.

The electrical power requirements necessary to operate the unit satisfactorily are listed on the serial plate located on the back panel of each dryer and in the specifications section of this manual. The electrical connection should be made to the terminal board, on the rear of the unit. It is absolutely necessary that the dryer be grounded to a known ground. Individual circuit breakers for each dryer are required.

Individual circuit breakers for each unit are recommended. Do not use ground-fault circuit breakers or ground-fault circuit interrupter outlets. The wiring diagram is located on the belt guard on the back of the machine.

TRANSIENT VOLTAGE SURGE SUPPRESSORS

Like most electrical equipment your new machine can be damaged or have its life shortened by voltage surges due to lightning strikes which are not covered by factory warranty. Local power distribution problems also can be detrimental to the life of electrical components. We recommend the installation of transient voltage surge suppressors for your new equipment. These devices may be placed at the power supply panel for the complete installation and don't require an individual device for each machine.

These surge protectors help to protect equipment from large spikes and also from small ongoing spikes in the power that occur on a day to day basis. These smaller surges can shorten overall life of electrical components of all types and cause their failure at a later date. Although they can't protect against all events, these protective devices have a good reputation for significantly lengthening the useful life of electronic components.

Electronic Components are helped to have a longer useful life when they are supplied with the clean stable electrical power they like.

We are including the following names and links to a few suppliers of these devices for those who don't currently have a source.

MANUFACTURER	LINK
MCG Surge Protection	mcgsurge.com
Eaton Corporation	eaton.com/us/en-us
Schneider Electric	se.com/us/en
Asco Power Technologies	ascopower.com/us/en
Emerson Electric Co.	emerson.com/en-us

GAS REQUIREMENTS.

The complete gas requirements necessary to operate the dryer satisfactorily are listed on the serial plate located on the back panel of the dryer. An individual gas shutoff valve is recommended for each dryer and may be required by local code (not supplied). The inlet gas connection to the unit is 1/2 inch [12.7] pipe thread for T-30/T-50 and 3/4 inch [19.1] for the T-80/T-120. A joint compound resistant to the action of liquefied petroleum gases should be employed in making pipe connections. A 1/8 inch NPT plugged tapping, accessible for test gage connection, must be installed immediately upstream of the gas supply connection to the dryer. A drip tee should be provided in the gas piping entering the unit to catch dirt and other foreign articles. All pipe connections should be checked for leakage with soap solution. Never check with an open flame. The recommended natural gas supply pressure is 7 inches water column (17.8 cm) at each dryer.

With the burners in operation, check the gas pressure at the threaded port in the end of the burner manifold. Adjust the dryer's gas control valve for 3.5 inches water column (8.89 cm w.c.) pressure at the manifold (Adjust T-30 -39 models to 3.4 in. w.c. (8.64 cm w.c.)).

For altitudes above 2,000 feet (610m) it is necessary to de-rate the BTU input. Contact your local distributor for instructions. L.P. gas conversion kits are available for this dryer. Contact your local distributor.

CAUTION: The dryer must be disconnected from the gas supply piping system during any pressure testing of that system. Do not expose the dryer's gas control valve to testing pressure.

Burner Set-Up

All gas burner manifolds should be checked for proper gas pressure while burning. Dryer manifold pressure should be set at 3.5 W.C. for Natural Gas while burner operating.

EXHAUST INSTALLATION. (Refer to Figure 2 at the end of section 6.)

Exhausting of the dryer(s) should be planned and constructed so that no air restrictions occur. Any restriction due to pipe size or type of installation can cause slow drying time, excessive heat, and lint in the room.

From an operational standpoint, incorrect or inadequate exhausting can cause a cycling of the high limit thermostat which shuts off the main burners and results in inefficient drying. Individual exhausting of the dryers is recommended. All heat, moisture, and lint should be exhausted outside by attaching a pipe of the proper diameter to the dryer adapter collar and extending it out through an outside wall. This pipe must be very smooth on the inside, as rough surfaces tend to collect lint which will eventually clog the duct and prevent the dryer from exhausting properly. All elbows must be smooth on the inside. All joints must be made so the exhaust end of one pipe is inside the next one downstream. The addition of an exhaust pipe tends to reduce the amount of air the blower can exhaust. This does not affect the dryer operation if held within practical limits. For the most efficient operation, it is recommended that no more than 14' (4.3m) of straight (8" (20.3cm) for T-30/50/80, 10 or 12" (25.4 or 30.5cm) for T-120) diameter pipe be used with two right angle elbows. When more than two elbows are used, 2' (61cm) of straight pipe should be removed for each additional elbow. No more than four right angle elbows should be used to exhaust a dryer.

Maintain minimum 1" (25) clearance between duct and combustible material.

If the exhaust pipe passes through a wall, a metal sleeve of slightly larger diameter should be set in the wall and the exhaust pipe passed through this sleeve. This practice is required by some local codes and is recommended in all cases to protect the wall. This type of installation should have a means provided to prevent rain and high winds from entering the exhaust when the dryer is not in use. A hood with a hinged damper can be used for this purpose. Another method would be to point the outlet end of the pipe downward to prevent entrance of wind and rain. In either case, the outlet should be kept clear, by at least 24" (610), of any objects which would cause an air restriction.

Never install a protective screen over the exhaust outlet.

When exhausting a dryer straight up through a roof, the overall length of the duct has the same limits as exhausting through a wall. A rain cap must be placed on top of the exhaust and must be of such a type as to be free from clogging. The type using a cone shaped "roof" over the pipe is suitable for this application.

Exhausting the dryer into a chimney or under a building is not permitted. In either case there is a danger of lint build-up which can be highly combustible.

Installation of several dryers, where a main discharge duct is necessary, will need the following considerations for installation. Individual ducts from the dryers into the main discharge duct should be at a 45 degree angle in the direction of discharge air flow.

NOTE: Never install the individual ducts at a right angle into the main discharge duct. The individual ducts from the dryers can enter at the sides or bottom of the main discharge duct. The main duct can be rectangular or round, provided adequate air flow is maintained. For each individual dryer, the total exhausting (main discharge duct plus duct outlet from the dryer) should not exceed the equivalent of 14 feet (4.3m) and two elbows. The diameter of the main discharge duct at the last dryer must be maintained to exhaust end.

NOTE: A small diameter duct will restrict air flow; a large diameter duct will reduce air velocity – both contributing to lint build up. An inspection door should be provided for periodic clean-out of the main duct.

NOTE: STATIC BACK PRESSURE should be a maximum of 0.3 in. w.c (7.6 mm w.c) at the rear exhaust outlet of the dryer. If multiple dryers are connected to the common duct, ensure the back draft damper is installed properly.

DRYER IGNITION (SOLID STATE IGNITION).

The solid state ignition system lights the main burner gas by spark. The gas is ignited and burns only when the gas-valve relay (in the electronic controller) calls for heat. The procedure for first-time starting of a dryer is as follows:

A. First, review and comply with the "WARNINGS ABOUT USE AND OPERATION" found on the inside front cover of this manual. Be sure the electrical power supply is connected correctly. The dryer **MUST** be properly grounded.

B. Make sure all gas supply lines are purged of air. Close the main gas shut-off valve and wait for five minutes before turning the valve back on.

C. Turn on main electrical power switch. The dryer may be started by following the "OPERATING INSTRUCTIONS" found later in this manual.

D. Natural gas and liquefied petroleum gas fired dryers both operate in the same manner. When gas-valve relay contacts are closed (indicating a demand for heat), the solid state ignition control will automatically supply energy to the redundant gas valve. Spark will continue until a flame is detected by the sensing probe, but not longer than 10 seconds. If the gas fails to ignite within 10 seconds, the gas will shut off for 15 seconds. The control will attempt to ignite two more times in a similar manner. If the gas fails to ignite after three tries, the gas valve closes and the system will "lock out". No further attempts at ignition will be performed automatically. It is then necessary to interrupt electrical power to the ignition system before making another attempt to light the burners. This can be done by opening the dryer door, allowing the dryer to come to a stop for 15 seconds, closing the door, and pushing the "Start" button. The dryer will then repeat the ignition trial cycle.

WATER CONNECTION – OPTIONAL MODEL

An uninterrupted water supply is required for models with the optional water dispensing fire response system. See the dryer dimension section for the location of the water line connection on the rear of the dryer. The thread size on the water valve is 3/4 - 11.5 NHT. The water supply pressure should be 40-120 psi (2.8-8.2 bar). The system will spray at a rate of 6 gallons of water per minute while spraying. A flexible supply line to the dryer is required to prevent damage to the water valve. It is critical to ensure that the room temperature is kept above freezing in the area of the water pipes.

DRYER SHUTDOWN

To render the dryer inoperative, turn off the main gas shut-off valve and disconnect electrical power to the dryer.

IT IS RECOMMENDED THAT THE INSTALLER TEST THE DRYER FOR OPERATION AND INSTRUCT THE USER BEFORE LEAVING THE INSTALLATION.

Section 3:

Dryer Operating & Programing Instructions

OPERATING INSTRUCTIONS

STARTING THE DRYER

1) Turn on power to the dryer.

2) Load the laundry.

Place laundry in tumbler and close the door securely. Be sure laundry does not get caught between the door gasket and front panel when closing the door. Maximum load is the dry weight capacity listed in the specification sheet. Do not exceed the listed capacity weight.

3) Select dry cycle.

Select the appropriate cycle for the type of load being washed. Use the "UP" and "DOWN" keys to change the cycle on the display to the desired cycle and press the enter button to select.

4) Start dry cycle.

Press enter to start the cycle. The display will show cycle information throughout the cycle.

5) Pause dry cycle / End dry cycle

Press the red pause button to pause the cycle. Select Start to restart the cycle or select Cancel Cycle to end the dry cycle.

END OF CYCLE

A tone will sound (if programmed) and the display will indicate that the cycle has ended. Immediately remove contents of dryer. Leave the door open when the machine is not in use.

PROGRAMMING / MANAGEMENT VIEW

ENTER PROGRAMMING MODE

1. In the cycle selection screen, scroll to Management View at the beginning of the cycle list and select enter.
2. Enter Passcode and confirm by pressing enter.
3. Select desired option.

EDIT CYCLES

Cycles may be edited in the Edit Cycles selection. Within Edit Cycles, cycles may be edited, copied, reordered or deleted. After making edits, select Back/Exit until out of the option. Confirm changes when prompted to do so. When finished, select Back/Exit until you have returned to the cycle selection screen.

AUTODRY CYCLES

Autodry cycles will dry the load to the programmed percent remaining moisture. Available moisture selections are: 25%, 20%, 15%, 10%, 7%, 5%, 3%, 1% and 0%. These can be changed by editing cycles within the Management View. When the desired moisture remaining target has been met, the dryer will advance to the next drying stage. The drying temperature for an Autodry cycle is determined by the programmed selection for Material.

- Cotton 190 degrees F
- Blend 160 degrees F
- Synthetic 140 degrees F
- Wool 140 degrees F
- Delicate 120 degrees F
- Ultra-delicate no heat

NOTE: Autodry cycles will perform best with loads of the same material. Performance will vary with mixed-material loads.

OVERHEAT SENSING

All O-Series dryers are equipped with an Overheat Sensing System that will detect abnormally rising temperatures. If rising temperatures are detected, the control screen will display OVERHEAT TEMPERATURE DETECTED and an alarm will sound. If the loading door is closed, dryer models with reversing tumblers will begin tumbling after 5 seconds. A 24 VAC output signal will also be sent to the auxiliary terminal block in the control box on the rear of the dryer. This signal is available for customers to use with a supplementary system of their choice. For dryer models with the optional water-based fire suppression system, water will also intermittently be sprayed into the tumbler. If the Overheat Sensing System has been activated, the dryer should be inspected safely and appropriately. After inspecting the dryer, it may be returned to service by resetting the controller by pressing the RESET button on the main control board.

O-SERIES DRYERS PROGRAMMING WITH DEXTERLIVE



Our O-Series dryers are simple and easy to program using DexterLive.com. This guide will provide an overview of some of the features DexterLive offers and how to create the cycles that fit your location's specific needs.

Set-Up an Account and Location

If you don't already have a DexterLive account, it is easy to register at DexterLive.com.

Once you have an account, you can create a new location and customize that location by a specific application. Simply select on-premise laundry as your location type and the application type option will be available.

Tip: If you have multiple applications, you can provide a generic name (e.g., Motel) and use the same custom programs across multiple locations.

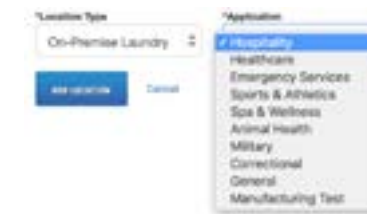

Add Equipment

Before programming cycles, you need to add equipment. Because functionality differs between model types, it is important to select the right model. You can name your machine, input the serial number, and add the DexterLive ID if you choose. However, this information is not required.

Tip: To create a generic program to be used in many locations, leave the serial number and DexterLive ID blank.

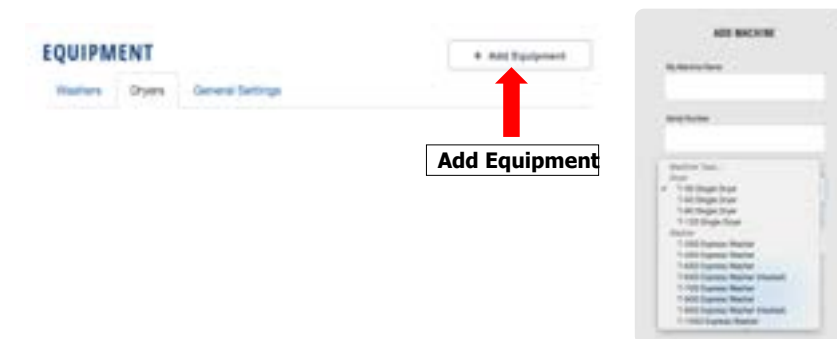

General Settings

General settings will set the global parameters for your location. These parameters will impact all washers and dryers added to that location.

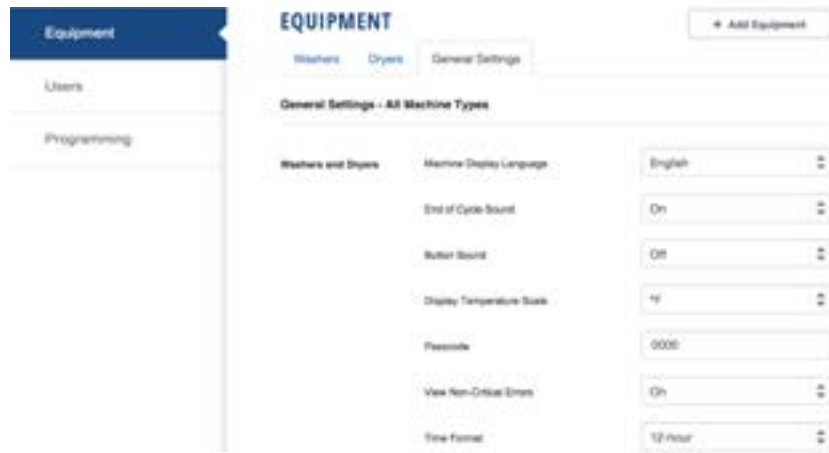

Setting	Options	Notes
Machine Display Language	Multiple	Changes the language of cycles, stages, and prompts that are displayed on the control. Individual cycles can still be set for different languages.
End of Cycle Sound	On / Off	Buzzer will sound when cycle is complete.
Button Sound	On / Off	Audible feedback when buttons are pressed.
Display Temperature	°F / °C	Choose between Fahrenheit or Celsius.
Passcode	0000 – 9999	Select a code for management screen access
View Non-Critical Errors	On / Off	Will display errors such as Slow Fill / Slow Drain during cycle. If OFF, these errors will still register in the cycle log, but will not be shown on the display.
Time Format	12 hr / 24 hr	Changes how time is displayed on the control.

Machine Settings

Most programming functions are available under the individual machine settings. Under this selection, you can review, edit, create, or delete cycles. There even is an option to enable or disable the ability to add time to a cycle.



Cycles

The cycle page allows you to add, edit, copy, delete, or reorder cycles.

	CYCLE NAME	TARGET TEMP	MATERIAL	TARGET			
Cycle 1	Towels	190°F	Cotton	Auto Dry - 1%	☰	🔄	🗑️
Cycle 2	Sheets - Cotton	190°F	Cotton	Auto Dry - 5%	☰	🔄	🗑️
Cycle 3	Sheets - Blend	160°F	Blend	Auto Dry - 5%	☰	🔄	🗑️
Cycle 4	Simple Cycle	-----	-----	-----	☰	🗑️	➕

Legend		
	Edit Cycle	Select anywhere on the cycle description (cycle name, target temp, material, or target) to open the cycle details for editing.
☰	Reorder Cycle	Select and hold to move a cycle up or down in the listing. This will change the order it is displayed on the control.
📄	Copy Cycle	This will duplicate the cycle. Tip: It is easiest to edit an existing cycle instead of creating a new cycle. Copy the cycle that is closest to the cycle you want to create and edit that cycle. If a default cycle doesn't meet your needs, select "Add Cycle" and choose a default cycle from another application. You can always change the cycle name in the edit section.
🗑️	Delete Cycle	This will delete an existing cycle.
➕	Add Cycle	This will allow you to add a preset cycle from another industry or another location.

Simple Cycle

Simple Cycle is a quick and easy way to set a time dry cycle on the control. Choosing Simple Cycle allows a user to set the time and temperature of a cycle. It is recommended to keep Simple Cycle as an option within the cycle list.

Cycle Settings

A cycle can be edited by selecting on the cycle name in the Cycles page. The name and language can be customized for that specific cycle.

Cycle 1 - Towels Settings

Setting	Options	Description
Cycle Name	User Entered	Preset cycles come loaded with a name, but the user can customize the name, including using other languages. See tip below for more information.
Language	Multiple	Sets the language prompts for a cycle. This does not change the language displayed in other sections nor does it change the language in DexterLive. See tip below for more information.
Anti-Wrinkle Protection	On / Off	When activated, anti-wrinkle will automatically tumble a load every 5 minutes from when a cycle is complete to when the door is open or for 12 hours after cycle completion. It is important to keep anti-wrinkle ON since it reduces instances of spontaneous combustion.
Cycle Type	Auto Dry / Time	Auto Dry cycles will utilize the moisture detection system to determine the moisture level in a load, reducing the risk of overdrying. Auto Dry cycles are programmed based on the type of material being dried. Time cycles can be programmed for time and temperature.
Material Type	Cotton Blend Wool Delicate Synthetic Ultra-Delicate	The type of material being dried is critical for Auto Dry cycles as it determines the temperature and suggested relative moisture remaining. See table below for temperatures by material type.

Temperature Recording	Off / Stages	Records the maximum temperature reached at the desired stage. This is important for certain applications where temperature is critical.
Reversing Delay	Off 30 secs 60 secs 90 secs 120 secs	For reversing dryers, this sets the time for which the tumbler will change directions. For instance, if set to 30 seconds, the tumbler will rotate clockwise for 30 seconds, then reverse and rotate counterclockwise for 30 seconds.

Tip: If a location has multi-lingual employees, the same cycle can be duplicated and programmed for different languages. For example, in a location with English and Spanish speaking employees, program White Sheets to the desired settings. Copy that cycle, set that cycle language to Spanish, and note the name change to Sabanas Blancas. This will allow all employees to read the necessary prompts and descriptions on the control.

Material Type Settings

Material Type	Temperature
Cotton	190 °F / 88 °C
Blend	160 °F / 71 °C
Wool	140 °F / 60 °C
Delicate	120 °F / 49 °C
Synthetic	140 °F / 60 °C
Ultra-Delicate	No heat

Stages – Auto Dry

Auto Dry cycles are comprised of two stages – a heating stage and a cooldown stage.

Stage	Parameters	Options	Notes
Heating	Temperature	Preset	Preset based on material type
	Auto Dry Level	100% - 75%	Auto Dry level and Moisture Remaining are correlating numbers, giving you the option to program towards a specific dryness level (i.e., 95% dry) or to a moisture remaining level (i.e., 5% moisture remaining). Both numbers are shown to accommodate different industry types.
	Moisture Remaining	0% - 25%	
Cooldown	Temperature	Not selectable	Auto Dry cycles are set for no heat on Cooldown. Any heat during cooldown could impact the moisture content of a load missing the desired target level.
	Time	2 – 120 minutes	Time in cooldown. Every cycle must include a minimum two-minute cooldown to reduce the risk of spontaneous combustion.

Stages – Time Dry

Time Dry cycles are typically encompassed of two stages – a heating stage and a cooldown stage. However, time dry cycles also allow you to have multiple heating stages with different temperatures. You can program up to 19 heating stages and 1 cooldown stage.

Stage	Parameters	Options	Notes
Heating	Temperature	No Heat 100 °F – 190 °F / 38 °C – 91 °C	Sets the desired temperature for the stage. Temperature is programmable in 5 °F / 3° C increments.
	Time	0 – 120 minutes	Maximum cycle time is 120 minutes,
Cooldown	Temperature	Not selectable	Time Dry cycles are set for no heat on Cooldown.
	Time	2 – 120 minutes	Every cycle must include a two-minute minimum cooldown to reduce the risk of spontaneous combustion.
Add Stage			Adds a heating stage. The stage that is added is a direct copy of the last heating stage and can be edited.

Optional Settings: Add Time

These settings will only apply to that specific model type. For instance, optional settings for the T-80 will not apply to a T-50. These will need to be set individually by model.



DexterLive can control time adjustment options for the end user. Turning Add Time off would restrict users from adding time once a cycle is complete or during a cycle.

Programming

Once all cycles are set, the programming file (called userconfig.xml) can be downloaded following the instructions on the programming tab DexterLive.com.



At the machine, you can enter management view by pressing up on the idle screen.



Simply insert the USB, scroll to Import User Data, and begin using your customized dryer cycles.

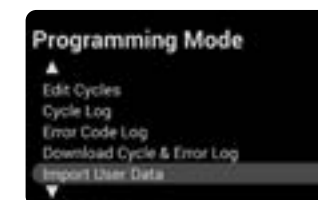

O-SERIES DRYER MANAGEMENT VIEW & MANUAL PROGRAMMING

Management View

To enter Management View, select the up button while on the Ready screen. Management view is currently only available in English.

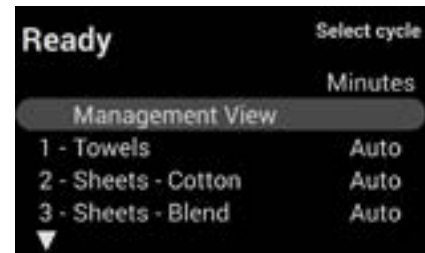

Passcode

Enter the passcode. The default passcode is 0000. It can be updated in DexterLive or in the management screens. Once changed, the passcode cannot be recovered without performing a factory reset.

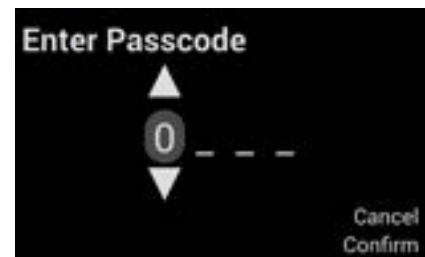

Programming Mode

This section controls machine settings and programming, and allows you to upload firmware or download cycle logs.

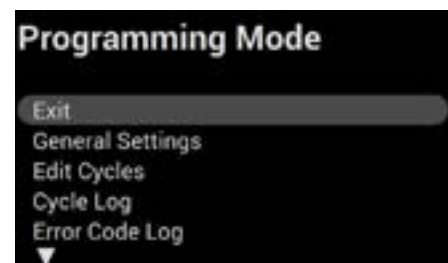

Programming Mode Selections

Selection	Description
General Settings	Provides basic machine information, time and date settings, and global machine settings
Edit Cycles	You can edit, copy, reorder, or delete cycles. Note: It is easier to program cycles on DexterLive.
Cycle Log	Displays detailed information from the last 300 cycles
Error Code Log	Displays the code and timestamp of the last 300 error codes
Download Cycle & Error Log	Provides data that can be used for management reporting, including idle time, lag time, cycles per shift, and error codes
Import User Data	Allows you to import a DexterLive.com programming file from a USB
Download User Data	Enables you to copy cycle information and upload to similar machine types
Sync Auto Dry	Syncs the stationary and rotating moisture detection boards.
System Upgrade	Upgrades firmware from a USB. Updated versions of the firmware can be found on DexterLive.com
Factory Reset	Resets all parameters, including cycle settings, to factory default.

General Settings

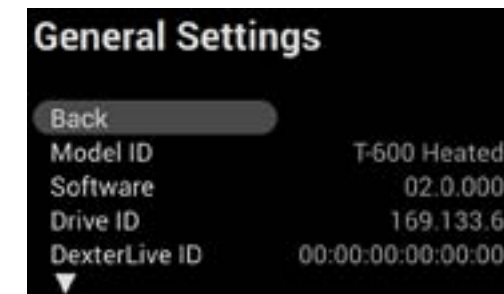

Selection	Description
Model ID	Model identifier – this is determined by the model jumper on the control board
Software	The version of firmware controller is using. Tip: Check on DexterLive.com or Go.Dexter for the latest firmware versions.
Drive ID	Variable frequency drive identification. Only on reversing models.

DexterLive ID	Unique DexterLive identification for the control
Language	Sets the global language for the machine
Passcode	Passcode for entry into the management screens. Default is 0000.
Temperature Units	Selects how the temperature will be displayed – Fahrenheit or Celsius
Time Format	Select between 12-hour or 24-hour time
Time Zone	Select the location's time zone. This will be updated for daylight savings time, depending on the time zone selected.
Date	Set the current date
Time	Set the correct time
Out of Service	Puts the machine out of service
Motor1 Hours	This tracks the hours the motor has been in use. If you change the motor, you can adjust this up or down as appropriate. 000000 – 999999
Motor2 Hours	This tracks the hours the motor has been in use and can be used to continue tracking total machine usage, even if Motor1 has been reset to 000000. Input is 000000 – 999999.
Non-Critical Error Codes	Turns off display of non-critical error codes such as no heat rise. These errors will still be recorded in the error log.
Simple Cycle	Sets where in the cycle list Simple Cycle is displayed. If set for "0", Simple Cycle will not be displayed.
Button Sound	Turns on / off audible feedback when button selections are made
Add Cycle Time	Turns on / off the ability to add time during or at the end of a cycle
End of Cycle Sound	Turns on / off end of cycle audible notification

Edit Cycles

Note: We recommend using DexterLive.com to edit, copy, reorder, or delete cycles.



Edit Cycle – Auto Dry

Note: You cannot change between auto and time dry on the control. That can only be done using DexterLive.com.

To edit a cycle on the control, simply select the cycle you want to edit. See the reference below for definitions and parameters. Note: Cycles or stages cannot be renamed on the control.

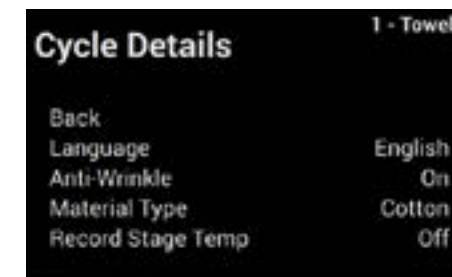

Definitions and parameters:

Parameters	Options	Description
Language	Various	Changes the language of the prompts and information displayed within the cycle. It does not change the global language of the machine.
Anti-Wrinkle	On / Off	Turns anti-wrinkle on or off at the end of that cycle. Note: It is strongly recommended that anti-wrinkle remains ON to avoid spontaneous combustion.
Material Type	Cotton Blend Synthetic Wool Delicate Ultra Delicate	Sets the material type (and subsequent temperature) for the load to improve the sensing capability of the wireless moisture detection system. See chart below for temperatures by material type.
Record Stage Temp	Off / Heating / Cooldown	The control will record the highest temperature reached in a stage. This is valuable for applications where temperature is critical.
Reversing Delay	Off 30 secs 60 secs 90 secs 120 secs	Only available on reversing dryers, this sets the time for which the tumbler will change directions. For instance, if set to 30 seconds, the tumbler will rotate clockwise for 30 seconds, then reverse and rotate counterclockwise for 30 seconds.

Material Type Settings

Material Type	Temperature
Cotton	190 °F / 88 °C
Blend	160 °F / 71 °C
Wool	140 °F / 60 °C
Delicate	120 °F / 49 °C
Synthetic	140 °F / 60 °C
Ultra-Delicate	No heat

Edit Stage – Auto Dry

Definitions and parameters:

Parameters	Options	Description
Temperature	None	Displays the set temperature for the cycle. Note: This is controlled by the material type selected.
Moisture	0%, 1%, 3%, 5%, 7%, 10%, 15%, 20%, 25%	Sets the target moisture remaining level for the cycle
Cooldown – Drying Time	2 – 120 minutes	Sets the cooldown time. Every cycle must have a 2 minute cooldown.

Edit Cycle – Time Dry

Note: You cannot change between auto and time dry on the control, use DexterLive.com

To edit a cycle on the control, simply select the cycle you want to edit. See the reference below for definitions and parameters. Note: Cycles or stages cannot be renamed on the control.

Definitions and parameters – Time Dry Cycles:

Parameters	Options	Notes
Language	Various	Changes the language of the prompts and information displayed within the cycle. It does not change the global language of the machine.
Anti-Wrinkle	On / Off	Turns anti-wrinkle on or off at the end of that cycle. Note: It is strongly recommended that anti-wrinkle remains ON to avoid spontaneous combustion.

Record Stage Temp	Off / Heating / Cooldown	The control will record the highest temperature reached in a stage. This is valuable for applications where temperature is critical.
Reversing Delay	Off 30 secs 60 secs 90 secs 120 secs	For reversing dryers, this sets the time for which the tumbler will change directions. For instance, if set to 30 seconds, the tumbler will rotate clockwise for 30 seconds, then reverse and rotate counterclockwise for 30 seconds.

Edit Stage – Time Dry

You can edit, copy, or reorder time dry stages.

Definitions and parameters:

Parameters	Options	Notes
Drying Time	1 – 120 minutes	Sets the drying time of that cycle. Note: The total cycle time cannot exceed 120 minutes, including cooldown.
Temperature	No Heat, 100 – 195F (in 5 degree increments)	Sets the temperature of that stage.

Copy Cycle

To copy a cycle, simply select the cycle you wish to copy, make any necessary edits to that cycle, and then save the changes. The cycle will then appear at the bottom of the cycle list named "Custom 1". The order in which the cycle is displayed can be adjusted following the steps to reorder a cycle. Note: Cycles or stages cannot be renamed on the control.

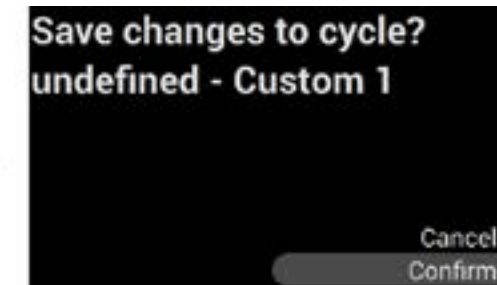

Reorder Cycle

To reorder a cycle, simply select the cycle you wish to move, and then proceed to move it up or down in the cycle list. Once it is in the right order, hit enter again to confirm the location.

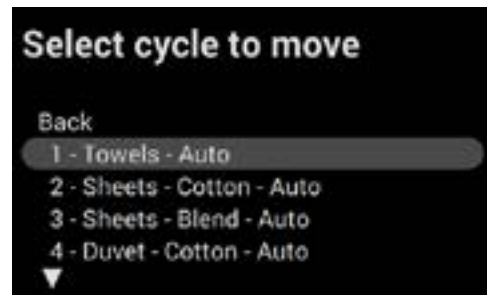

Delete Cycle

To delete a cycle, select the cycle you wish to delete and confirm your selection.

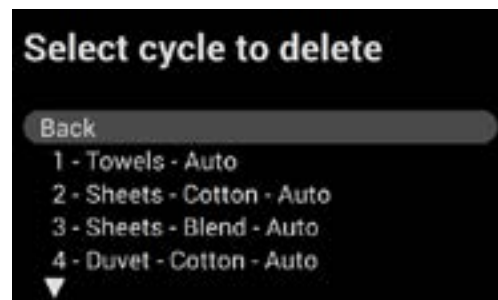

Cycle Log

The Cycle Log will display detailed information of the last 300 cycles. This includes:



Information	Description
Date / Time	Displays the day and time the cycle start. Cycles are listed with the most recent cycle first.
Actual Time	Time from when the cycle is started to when the cycle ends.
Idle Time	Time from when the door is opened to the start of the next cycle.
Target Time	Programmed cycle time. This is always set to 2:00 on auto dry cycles.
Max Temperature	The highest temperature reached during a cycle.

Error Code Log

The Error Code Log will display the code, date and time of the last 300 errors. It will display the most recent error first.

Download Cycle & Error Log

You can download detailed data on cycle and error codes. This will allow you to analyze the productivity of your laundry, including downtime and productivity by shift. The control will populate all data into one file. If you have multiple machines at a location, all data will be populated in one file. See reporting information for instructions on how to utilize this feature.

Import User Data

This setting enables you to import cycle settings configured on DexterLive.com. Simply insert a USB with the user file (userconfig.xml), select "Import User Data", select Confirm, and the user file will be uploaded to the machine. It will replace all other cycles previously programmed.

Download User Data

To copy cycles directly from one machine to another, insert a USB, select "Download User Data", and the user file will be copied. This file will only be applicable to similar model types.

Sync Auto Dry

If a moisture detection board is replaced or becomes unpaired with the control board, a sync is required. Simply align both the stationary and rotating boards on the back of the machine and select Sync Auto Dry. If the sync is successful, the board will display "Auto Dry Sync Successful". Please reference the service manual for troubleshooting guides if the sync is not successful.

System Upgrade

To upgrade firmware, select System Upgrade and confirm the upgrade. This will keep all programmed cycles and cycle and error code logs. Data, and the user file will be copied. This file will only be applicable to similar model types.

Factory Reset

Select Factory Reset to return all settings, including programmed cycles and settings to the factory default settings. This will clear all cycle and error code logs, but will retain the motor hours.



Section 4:

Service Procedures,
Trouble Shooting,
and Schematics

Service Procedures

Removing Top for Low Clearance Entrances

1. Remove front upper service panel by removing the four Phillips head screws.



2. Remove top cover by removing the sixteen 5/16 screws holding the top cover, five on each side and the center six holding the cover to the burner housing.
3. Top side removal, remove the two 5/16 screws holding each side.

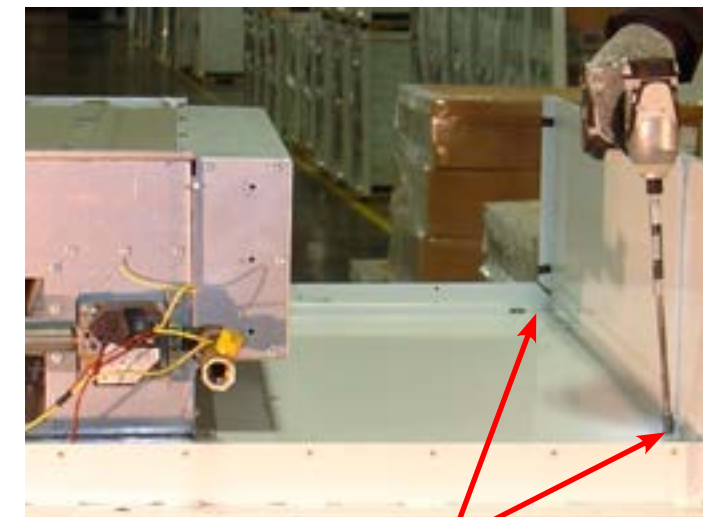

5/16 head screws

4. Remove Burner Assembly.
 - A. Disconnect wires from gas valve, brown and yellow wires and remove yellow ground wire bolted to the burner housing. Remove brown and orange wires from high limit thermostat. Remove igniter high voltage lead and the black heat sense probe wire.

Removing Top for Low Clearance Entrances Continued.

- B. Remove the three 5/16 screws holding left side of burner.

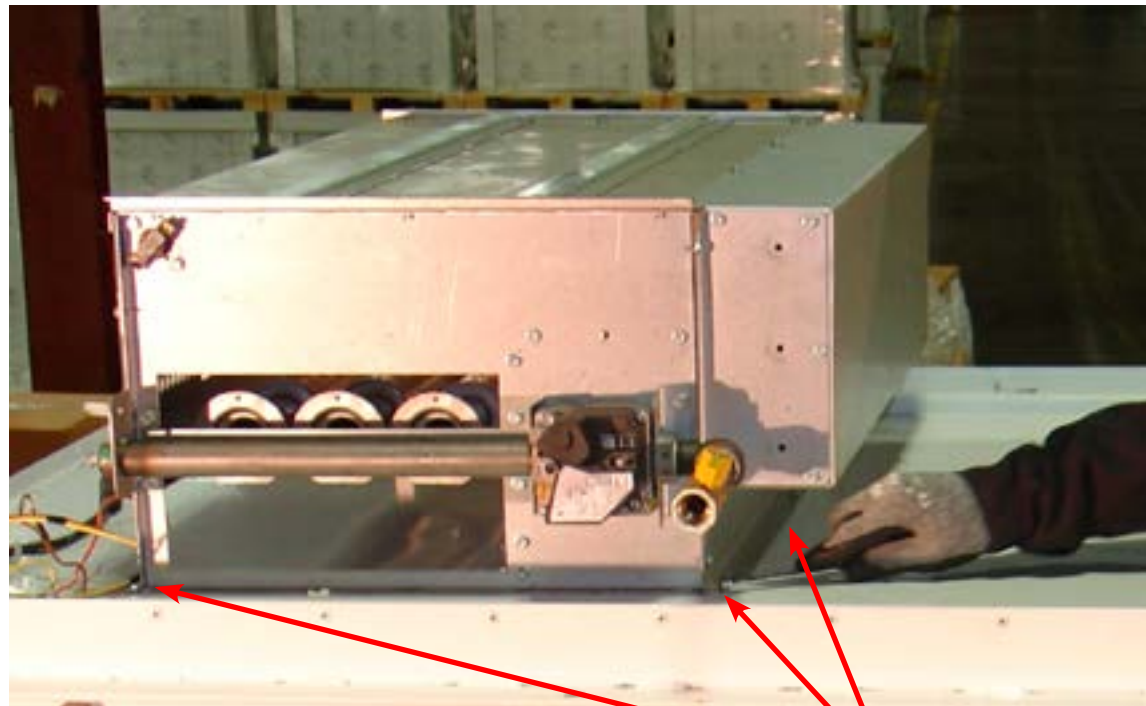

5/16 head screws

- C. Remove the two front 5/16 screws holding burner to top deck.
D. Remove one Right rear 5/16 screw holding burner to top deck.
5. Next lift left side of the burner 1/2" and slide to the left to free it from the right hold down bracket.
6. After freeing burner from hold down bracket slide burner assembly to the rear and with two people lift burner assembly from top deck.



7. Re-assemble in reverse order

Pressure Testing

The dryer and its individual shutoff valve must be disconnected from the gas supply piping system during any pressure testing of that system at test pressures in excess of 1/2 psig (14" water column). The dryer must be isolated from the gas supply piping system by closing its individual manual shutoff valve during any pressure testing of the gas supply piping system at test pressures equal to or less than 1/2 psig.

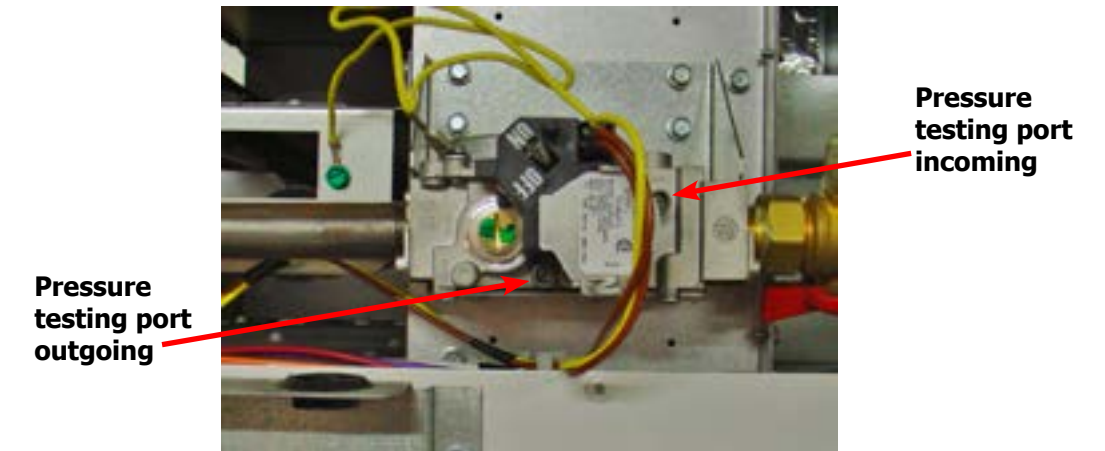

Clothes Door Removal

1. Open door and remove inner hinge plate cover by removing the two Phillips screws.
2. The clothes door may be removed from the hinge bracket by unscrewing and removing the top 3/16 allen head pivot screw located at the door upper hinge point, you will also need to use a 1/4 allen wrench in the lower fastener.
3. Next lean the door out of the top of the hinge bracket and lift the door from the bottom hinge pin.

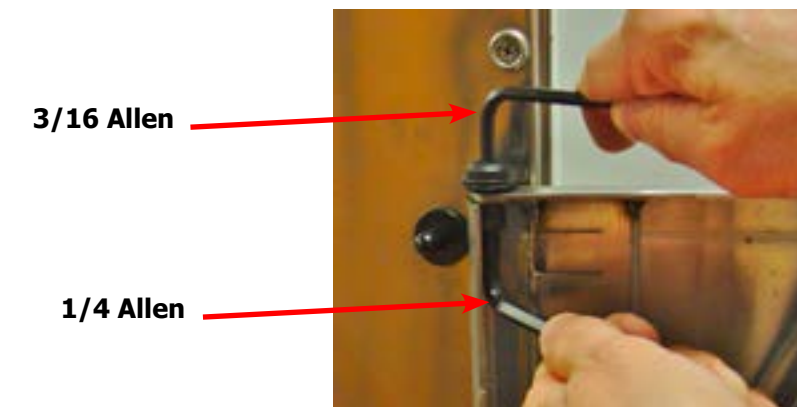

Front Panel Removal

1. Power down machine
2. Remove the two Torx "T10" screws and tilt down control & touch pad.



T-10 Torx
Screw

3. Disconnect main harness and USB harness from board and feed through 2" plug.

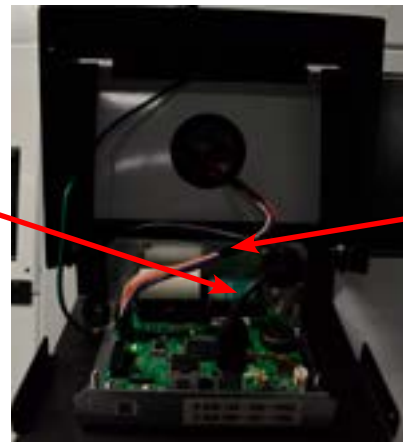

Main Harness
Plug

Main Harness
Plug

Front Panel Removal Continued.

4. Remove the eight white Torx "T-20" screws, Next remove the ten Phillips screws.



5. Disconnect red and black door switch wires from 1/4" connectors at main harness in upper right cavity.
6. Re-assemble in reverse order.

Door Switch Removal & Installation

1. Remove front panel (see Front Panel Removal).
2. Next disconnect door switch wires from back of loading door switch. Remove door switch by depressing the two tabs on switch and remove from the front of the panel.
3. Re-assemble in reverse order.

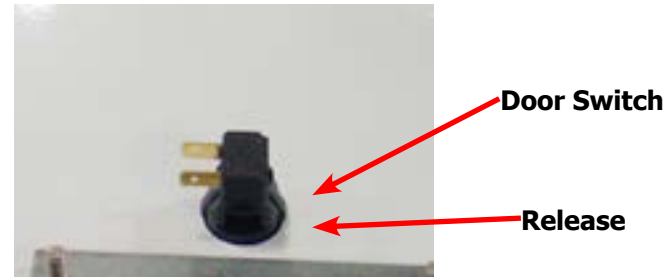

Door Switch Operation & Testing

The normally open door switch must be closed (0 ohms resistance) for the motor and heat circuit to operate. When the door is opened, the door switch opens the 24 volt control circuit.

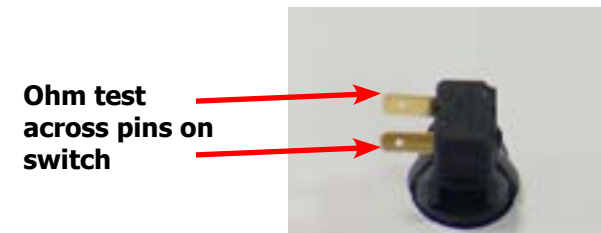

120Lb Loading Door Reversal

1. Remove upper service panel by removing the four Phillips screws.
2. Remove cloths door, (see Clothes Door Removal).
3. Remove front panel, (see Front Panel Removal).
4. Remove the hinge strap by removing the four hinge strap Phillips head screws.

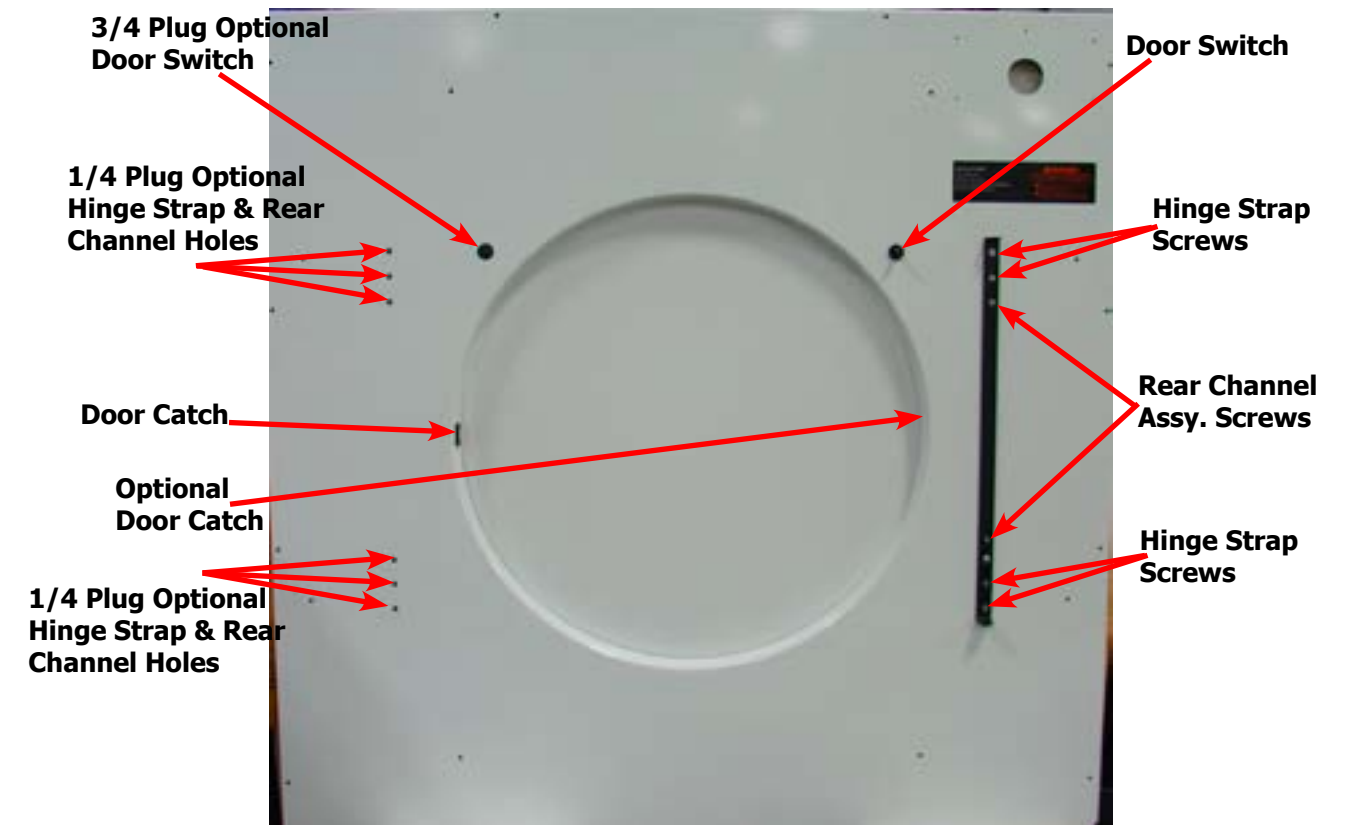

120Lb Loading Door Reversal (Continued)

- Remove the channel assembly. Remove the two channel assembly Phillips head screws from the front side of the panel.
- Remove door switch by depressing tab and removing through front.

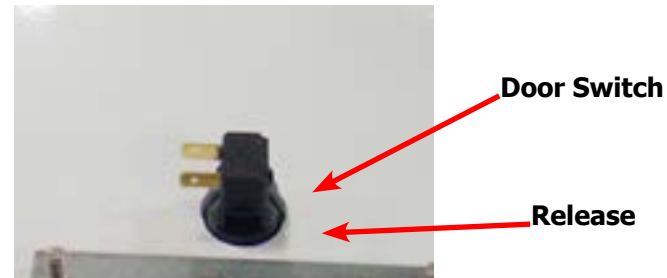

- Remove 1" plug on left side and insert into switch hole on the right side.

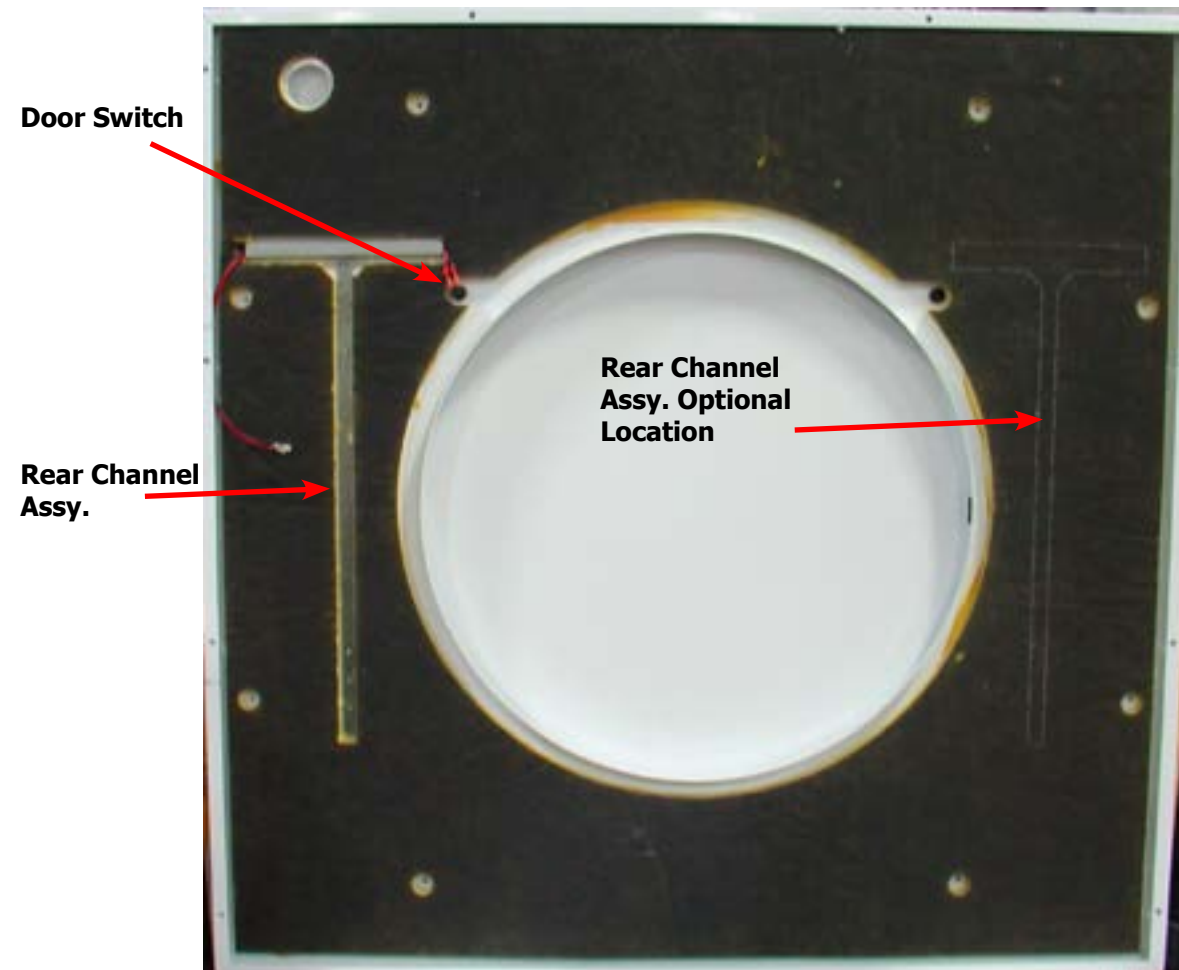

- Remove perforated insulation on left side for hinge channel assembly placement.
- Remove the six 1/4" hole plugs and transfer to the right side hinge strap and channel assembly holes.
- Reinstall door switch into left side.

120Lb Loading Door Reversal (Continued)

- Re-install channel assembly and two Phillips head screws, making sure door switch wires are routed to the outside of the machine.
- Re-install hinge strap by installing the four Phillips head screws.
- Install loading door catch (p/n 9086-015-002) by using two rivets (p/n 9491-009-004).
- Reattach loading door and hinge plate, (see Loading Door Removal).

Note: Next is routing door switch extension wires, wires are provided in Owner's manual bag.

- You will have to cut a slit in the 3/4" Plugs in the top deck to run the extension wires. The plugs are located at the front corners of the top deck. Connect extension wires on right side to main harness connections. Next connect red and black wires off of the door switch to the extension wires.



- Re-install front panel, (see Front Panel Removal).

Clothes Door Latch Adjustment

- Loosen the lock nut on the latching stud. It is located directly behind the door handle.
- Open the loading door.
- Screw the door catch stud in or out as necessary and then retighten the lock nut.



Installation of Clothes Door Window & Gasket

- 1: Remove the loading door.
- 2: Place the clothes door, with its face down, on a solid surface.
Note: Pre-warming the gasket under a heat lamp makes the installation much easier.
- 3: Put the door glass gasket on the loading door with the ridges in the wide side up.
Locate the seam at the door latching stud.
Note: The gasket has one narrow opening on one side and a wide opening on the other.
The narrow side mounts to the door. The wide side holds the glass. The wide side has ridges on one interior lip. This ridged side should go up with the door lying face down.
- 4: Coat the inside and outside of the gasket with rubber lubricant or liquid soap.
- 5: Slide the glass into the middle of the gasket with half of the glass above the door and half below the door.
- 6: While pressing on the glass, use a modified screwdriver (grind the end off so that it is round and put a slight bend in it) and run it around half of the glass.
- 7: With half of the glass installed, turn the door over and repeat step 6.
- 8: Insert the modified screwdriver at the 6 o'clock position and pry the glass up enough to install the door glass support spacer (small diameter rubber tube).



Glass inserted half way

Pressure Regulator Adjustment

Use the following procedure whenever it is necessary to check the pressure regulator setting.

NOTE: Any adjustment of the pressure regulator must be made with a manometer attached at the plug in the main burner manifold.

- 1: Shut off the gas supply to the dryer.
- 2: Remove the 1/8" pipe plug from the end of the main burner manifold.
- 3: Attach a manometer to the manifold end.
- 4: Remove the pressure regulator cover screw on the gas valve.
- 5: Open the shut-off valve, and operate the dryer.
- 6: Adjust the pressure for a manometer reading of 3.5" water column gas pressure.(11.0" for L.P.)
NOTE: The main burners must be operating when adjusting the pressure regulator.
- 7: Shut off the gas supply to the dryer. Remove the manometer and install the 1/8" pipe plug in the manifold.
- 8: Open the shut off valve, start the dryer and check for gas leaks while the burners are ignited.

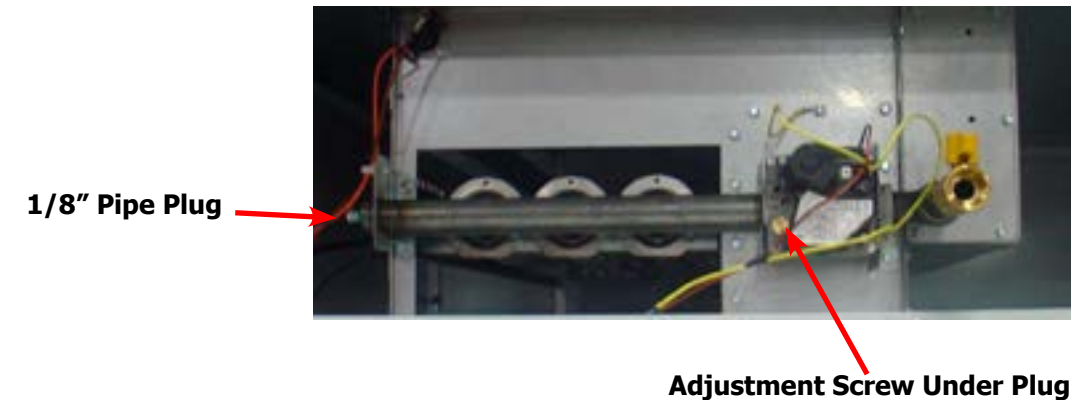

1/8" Pipe Plug

Adjustment Screw Under Plug

Gas Valve Removal

1. Disconnect gas Line from gas shut-off union.
2. Remove the six 5/16 screws from the gas valve bracket and remove valve, manifold and bracket assembly.

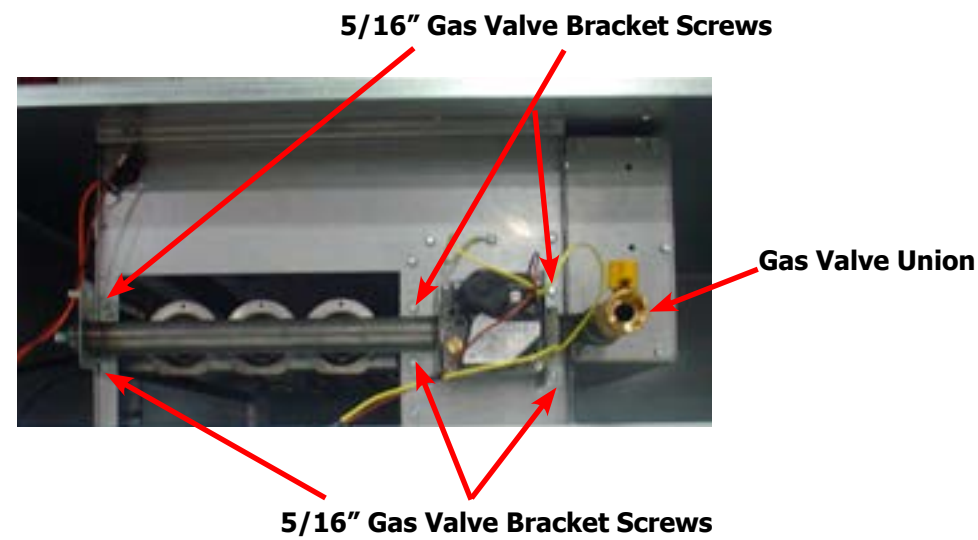

Main Burner Orifice Removal

1. Remove gas valve assembly, (See Gas Valve And Manifold Removal).
2. Using a 1/2 inch socket remove orifice.
3. When re-installing use reverse operation, (no sealer recommended on office).

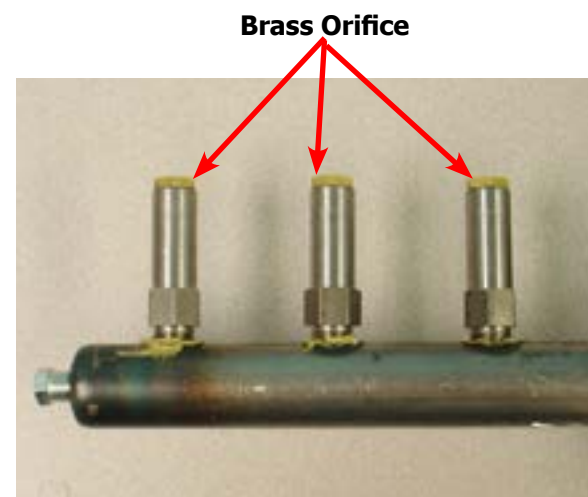

Burner Tube Removal

1. Remove gas valve assembly, (See Gas Valve And Manifold Removal).
2. Remove the six 5/16 screws, lift up tube and slide out rear of burner housing.
3. Re-assemble in reverse order, (Note: when reinstalling burner tubes make sure gas holes are on top).

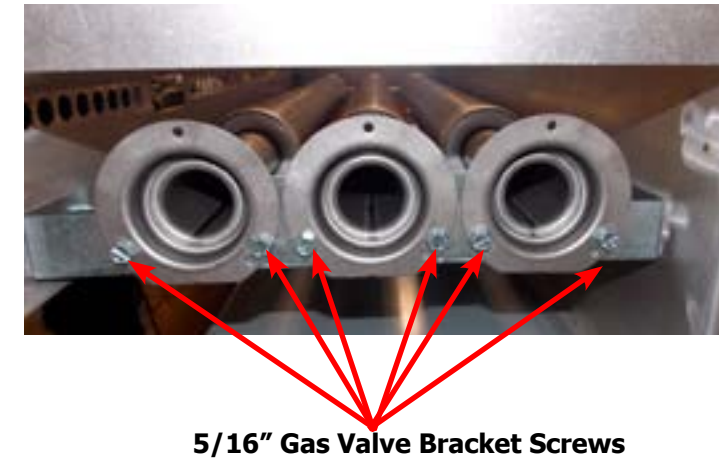

High Limit Thermostat Locations & Functions Burner Housing

This hi-limit is located on the rear of the burner housing.

- 1: The thermostat opens the circuit to the main burners in the event of malfunction in the gas control area or temperature control. This thermostat will open quickly if there is a significant loss of air flow over the burner area.
- 2: It is held in place by two screws. There are spacers between the thermostat and bracket which must be used to give proper operation.

Removal : To remove the hi-limit thermostat on the side of the burner housing, remove the terminal of each wires attached to the thermostat. Lastly, remove the mounting screws holding the thermostat to the burner housing.

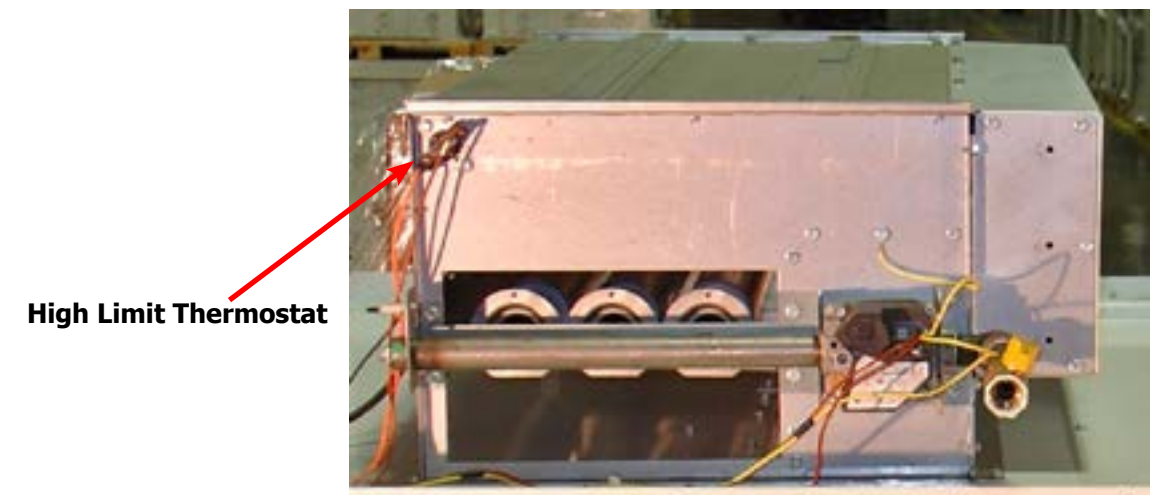

Manual Resettable Over Temperature Safety Thermostat

The second hi-limit thermostat is located outside the rear exhaust opening mounted on the left side of the exhaust duct at the rear outlet height.

- 1: The manually resettable thermostat limits the operating temperature a dryer can reach should some abnormal situation occur.
- 2: Should the thermostat be tripped, the dryer will cease to heat until the thermostat is reset. Once the dryer cools, the thermostat may be reset by pushing the button in.

REMOVAL: To remove the manual resettable over temperature safety thermostat next to the exhaust duct. First, remove the terminals of each wire attached to the thermostat. Next, remove mounting screws holding the thermostat to the dryer cabinet.

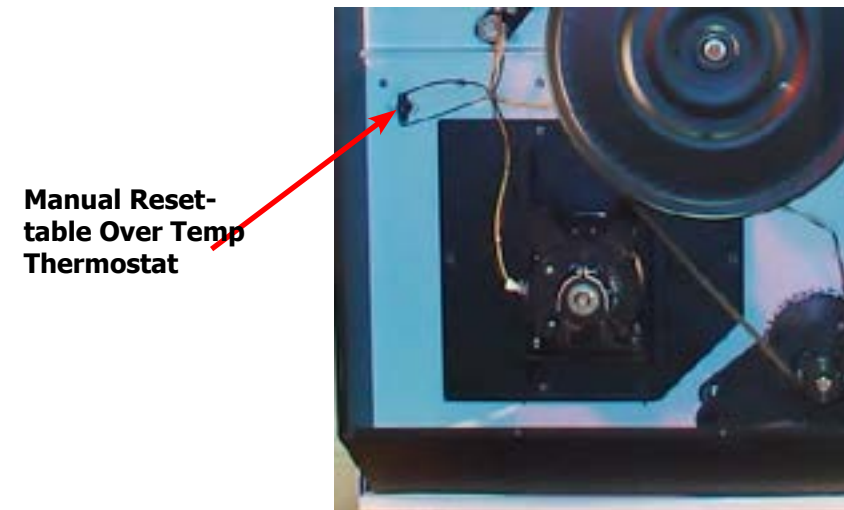

Airflow switch removal and adjustment

The air switch assembly is part of the ignition safety circuit and insures that the burner doesn't operate unless there is airflow. If this doesn't happen, ignition will not occur. The air switch assembly is located on the back of the dryer.

1. To adjust the switch, loosen the lower screw on the micro switch. Moving it forward will allow the switch to engage earlier.
2. To remove the switch assembly.
 - a. Disconnect wires.
 - b. Remove the five 5/16 screws.
3. Re-assemble in reverse order.

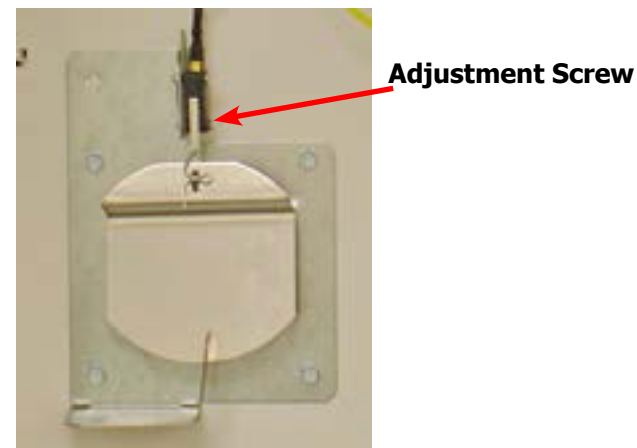

Electronic Ignition Module

This machine uses an electronic spark ignition system to directly light the burners.

- 1: The electronic ignition module (gray box) is located inside the rear control box.
- 2: The red wire from the transformer provides 24 VAC through the 1.5 amp fuse and into the module to operate the entire direct ignition system.
- 3: The black colored hi-voltage wire (spark plug type) plugs onto the post connector on the module, and the multi-wire plug fits into the side of the module.

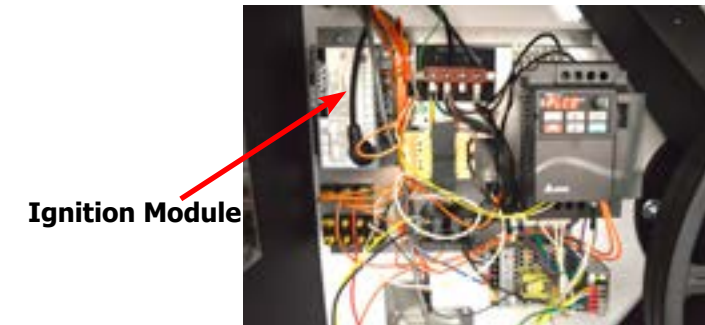

NOTE: Proper grounding of the ignition system (yellow wires) is very critical for proper ignition sequence. If there is no spark or intermittent spark, check black hi-voltage lead wire for damage or cracks in insulation. This lead wire must not be taped or connected to any metal edges along its length to prevent pinching and arcing. Also, do not bundle this wire with other wires.

Spark Electrode Assembly-Removal

- 1: Disconnect wires to electrodes.
- 2: Remove two screws to detach electrode assembly.



Note: Spark gap and electrode location are important. If the electrode is damaged or mounting is changed the spark gap may not be correct for ignition to occur. Check for cracks in the ceramic insulator. Replace electrode assembly if necessary. Also check for carbon or foreign material on the electrodes and clean if necessary.

Spark Electrode Assembly-Function

Step 1: The spark electrode and sensing electrodes are located directly at the side of the burner housing.

Step 2: The electrode with the black hi-voltage wire conducts the spark to the center grounding probe, directly over the burner.

Step 3: The electrode with the black sensing wire detects ignition and monitors flame by signaling the module.

NOTE: Proper grounding of the ignition system (yellow wires) is very critical for proper ignition sequence.

Ignition System-Function & Sequence

During normal dryer operation, the following occurs:

1. The dryer electronic control calls for heat.

2. From the 24VAC control transformer, voltage for the heat circuit is applied to the control through the door switch. If the control detects that the heat should be on, a circuit is closed providing power through the over-temp thermostat, the air damper switch, the high limit switch and the motor centrifugal switch to the ignition module.

3. Once the 24VAC reaches the ignition module on the red wire, sparking occurs at the ignition electrode and 24VAC is applied to open the gas valve.

3. Once the flame is established, the sensing electrode detects the presence of flame and the sparking stops.

4. If for any reason the flame is not established in a period of 10 seconds, the electronic control will try this sequence for 3 tries. Normally the 10 seconds "Trial For Ignition" period is ample to establish and prove flame.

5. If the flame is shutdown or blown out during operation, the ignitor will immediately go into "Trial. For Ignition" again for 10 seconds.

6. However, at the end of 3 separate retries of 10 seconds "Trial for Ignition", the flame is not established, the ignition system goes into "Safety Lock-Out" and will not reactivate the "Trial for Ignition" until there is a current interruption for a period of 15 seconds. This interruption can be provided by opening the dryer loading door and allowing the machine to come to a complete stop for 15 seconds.

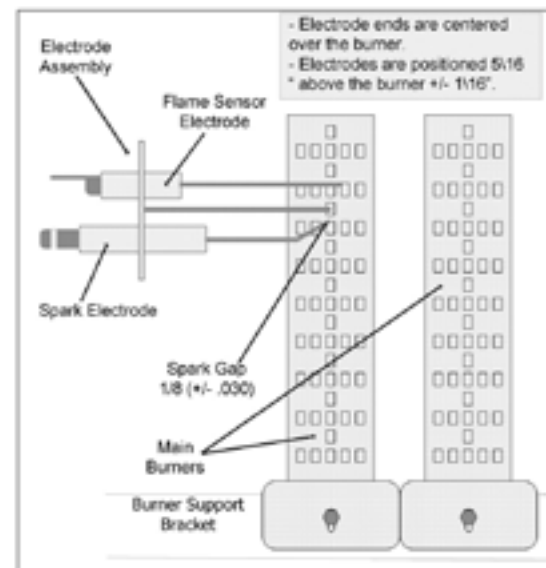

Motor Drive Belt Replacement

The motor drive belt has a spring tension provided by the motor tension spring.

1. To replace the motor drive belt the final drive belt should be removed by using a pry bar starting the belt over the edge of the pulley and rotating around until the belt works itself off

Final Drive Belt Replacement

1. To replace the final drive belts turn the cylinder slowly by hand and work the belt off of the large pulley.

Drive Motor Replace

1. Remove drive belt, (see Final Drive Belt Removal).
2. Disconnect spring and chain.
3. Using 1/4" Allen wrench remove motor rod locking collar.
4. Remove rod and motor.
5. Re-assemble in reverse order.



Idler Pulley removal

1. Remove drive and tumbler belts, (see Belt Removal).
2. Remove 15/16" nut and washer. **Note:** has loctite on nut may require heat.
3. To remove bearings from pulley.
 - a. Remove inside snap ring and drive out bearings, note: Make sure spacer is replaced when reassembling.
4. Re-assemble in reverse order.



Idler Arm Assembly Removal

1. Remove drive and tumbler belts, (see Belt Removal).
2. Remove idler pulley, (see Idler Pulley Removal).
3. Remove the two 3/4" tension adjustment bolts.
4. Remove Locking collar from idler arm pivot rod.
5. Remove rod and arm assembly.
6. Reassemble in reverse order.

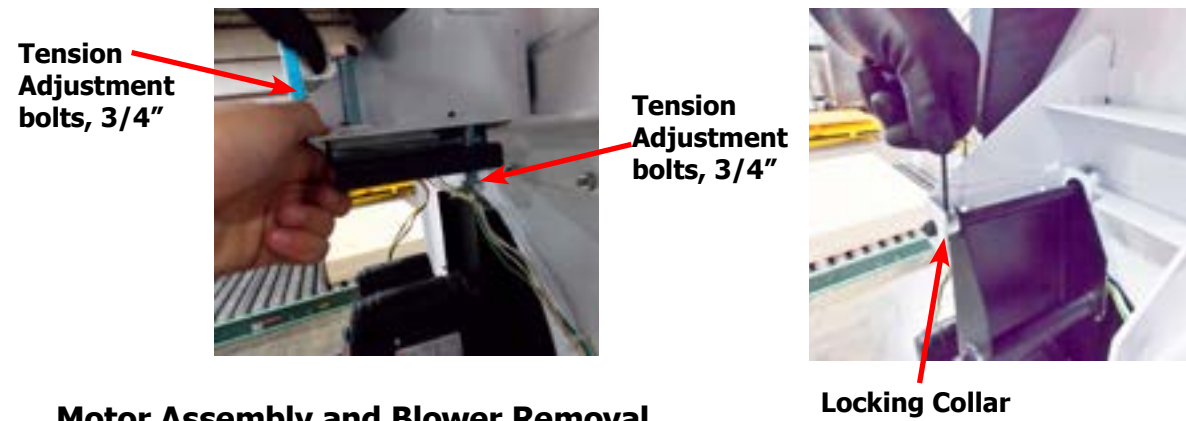

Motor Assembly and Blower Removal

1. Remove belts, (see Belt Removal).
2. Remove idler pulley, (see Idler Pulley Removal).
3. Disconnect harness to motor from rear electrical box.
4. Remove the six 1/2" Nuts and remove assembly.
5. To remove blower impeller, remove set screw. Make sure to note position of set screw for reassembly.
6. Re-assemble in reverse order.

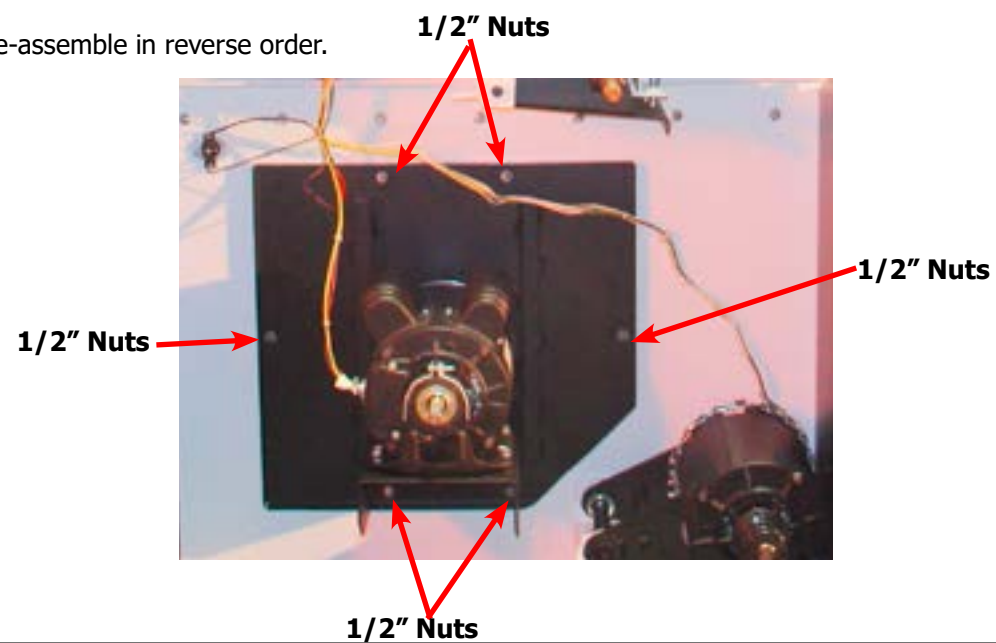

Tumbler Pulley Removal

1. Remove drive and tumbler belts, (see Belt Removal).
2. Remove idler pulley, (see Idler Pulley Removal).
3. Use 3/4" socket to remove retaining bolt, washer, and star washer.
4. Using three jaw puller remove pulley and tolerance ring.
5. Re-assemble in reverse order.

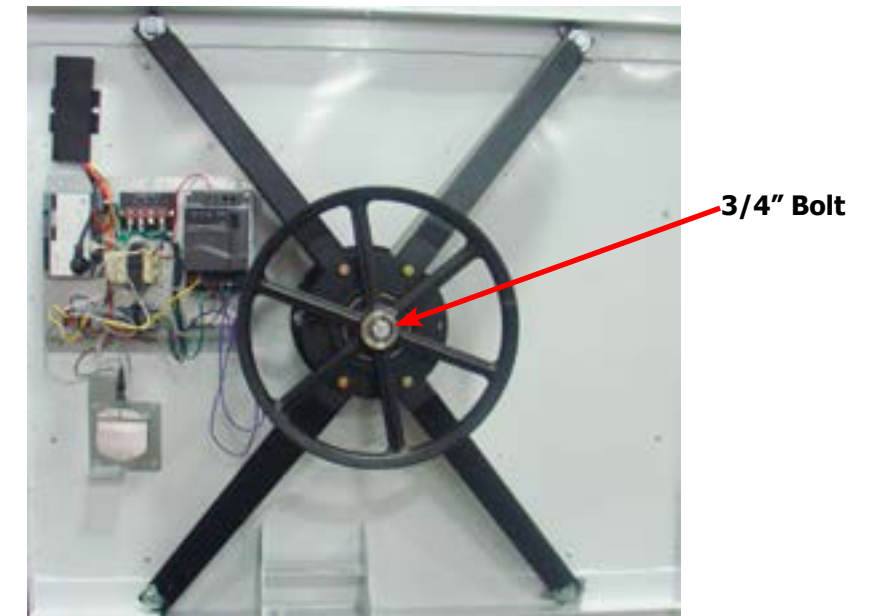

Tumbler Adjustment

You will need to first determine which direction the tumbler needs to be adjusted. The adjustment will be accomplished by installing or removing shims to the outer ends of the support arms.

1. Loosen outer support arm bolt.
2. Insert shim and retighten bolt, (you will need to check and may need to repeat process until desired movement is accomplished).



Tumbler Assembly Removal

1. Remove drive and tumbler belts, (see Belt Removal).
2. Remove idler pulley, (see Idler Pulley Removal).
3. Remove tumbler pulley, (see Tumbler Pulley Removal).
4. Remove front panel, (see Front Panel Removal).
5. Use three jaw puller to push out tumbler assembly.
 - a. First re-insert bolt to protect shaft end.
 - b. Secure jaws onto bearing housing and drive tumbler assembly forward until off of shaft journal.

Note: the tumbler assembly weighs 190 Lbs / 86 Kg.

6. Using more than one person slide the assembly forward and tilt up on end.
7. Re-assemble reverse operation.

Bearing Housing Removal

1. Remove drive and tumbler belts, (see Belt Removal).
2. Remove idler pulley, (see Idler Pulley Removal).
3. Remove tumbler pulley, (see Tumbler Pulley Removal).
4. Remove front panel, (see Front Panel Removal).
5. Remove tumbler assembly, (see Tumbler Removal).
6. Remove the four support arm outer 7/16" bolts and nuts.
7. Remove the four outer support arm 5/8" bolts.
8. Remove the six inner bearing housing bolts and remove support arms and bearing housing.
9. Re-assemble reverse operation.

RMC Replacement and Adjustment

The 3 main components are the Sensing strip mounted in the tumbler. The rotating sensor mounted on the trunnion, and the stationary sensor sending and receiving the signals from the sensing strip.

9558-034-001
Sensing Strip, Moisture



9857-248-001
Rotating PCB, RMC



9857-247-001
Stationary PCB, RMC



Removing RMC Stationary Board

To Remove the Stationary PCB, RMC

1. Disconnect Harness.
2. Remove the 2 5/16" side cover screws.
3. Remove the 4 5/16" to remove the Stationary board assembly.

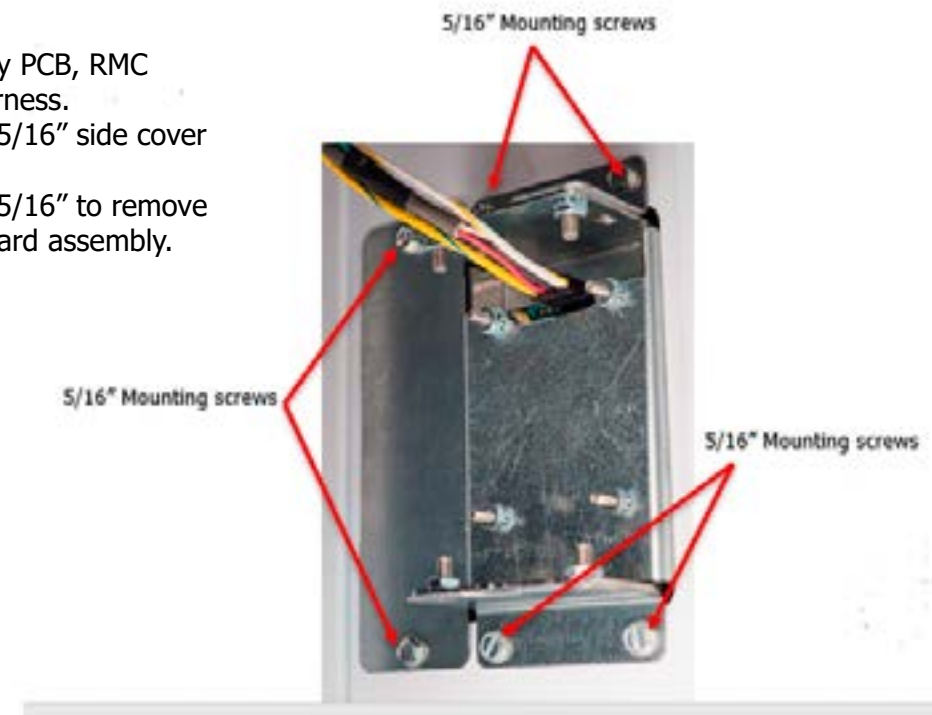

Removing RMC Rotating Board

To Remove the Rotating PCB, RMC

1. Disconnect Harness.
2. Remove the front and rear 5/16" screws.
3. Remove the Rotating module from machine.
4. Reinstall in reverse order.



Adjusting the RMC Stationary PCB

After replacing Stationary Board.

1. Loosen the 4, 3/8" adjustment nuts.

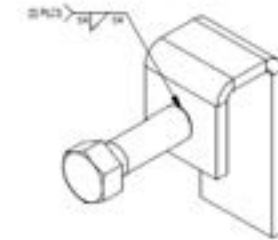

2. Install the adjustment gauge (8545-065-001) the gap is 3/16". (Make sure the stationary board cover is in place.)

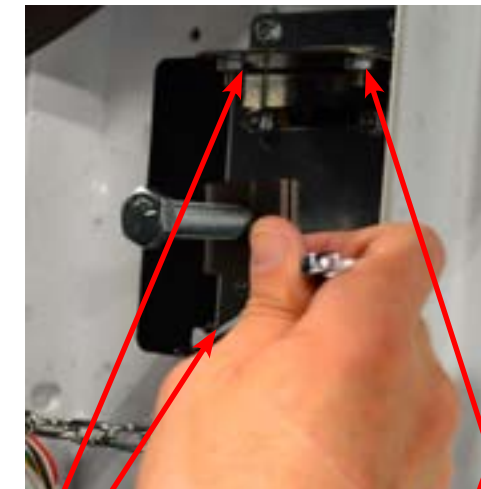

3. With gap tool installed push until the stationary board comes in contact with rotating board. This will set the spacing at 3/16 of a inch between the stationary and rotation PCB boards.

Right side adjustment nut tighten First.

4. Tighten the Right side first then the left side.

Left side upper and lower tighten after right side



5. Replace the left side cover. Reconnect the harness to the stationary board.

Sync Auto Dry

If a moisture detection board is replaced or becomes unpaired with the control board, a sync is required. Simply align both the stationary and rotating boards on the back of the machine and select Sync Auto Dry. If the sync is successful, the board will display "Auto Dry Sync Successful". Please reference the service manual for troubleshooting guides if the sync is not successful.

Notes

Dryer Trouble Shooting

DRYER ERROR MESSAGES

The O-Series dryer control reacts to various abnormal conditions by displaying an Error message. These messages usually contain the "Error" text, and then a general description of the message. Below is a listing of Error messages separated by each potential displayed message in bold face. Each is followed by:

- Condition that creates the displayed message on the control
- Action that the control takes responding to the condition
- Exit is the method the user (or the control) should use to bring the machine back to normal operation.

The actual displayed message on the control may contain the general description listed below and additional details (such as number or additional text). However, the condition, action or exit qualities of the error message should be the same for all variations.

OPERATION IN PROGRESS	
Condition	This error occurs when the user is attempting to start a machine operation while another operation is ending.
Control Action	When detected, the control does not respond to user input on the buttons. There is no delay in the action once the criteria are met. The control will finish the current operation while displaying "OPERATION IN PROGRESS". Once the operation is complete, the error will no longer be displayed and the control will respond to user input normally.
Exit	The error will be reset automatically once the current operation is complete.
Customer Action	Once cycle is ended and the Door is opened and closed you may select the next cycle.
POWER LOSS	
Condition	This error occurs when the Main Control Board detects a total loss of 24VAC power.
Control Action	When detected, the control turns off the motor and the heating relay. There is no delay in the action once the criteria are met.
Exit	The machine will not start and the Error Code will continue to be displayed until the condition is no longer present. Once the condition is removed, the machine still will not start and the Error Code will continue to be displayed until the prompt is followed to Reset the Error and return the machine to Idle Mode.
Customer Action	Test incoming Voltage. Make sure on correct Transformer tap. Test step down transformer make sure voltage within range.

BROWN OUT	
Condition	This error occurs when the Main Control Board detects less than 21VAC at the 24VAC input.
Control Action	When detected, the control turns off the motor and the heating relay. There is no delay in the action once the criteria are met.
Exit	The machine will not start and the Error Code will continue to be displayed until the condition is no longer present. Once the condition is removed, the machine still will not start and the Error Code will continue to be displayed until the prompt is followed to Reset the Error and return the machine to Idle Mode.
Customer Action	Test Incoming Power make sure Transformer is on the correct tap. The controls transformer is located inside the control trough and steps a range of 208 to 240 volts down to 115 volts. There are two terminals on the controls transformer for the primary (incoming) power. Use the terminal marked "208V" for power supplies between 200 and 219 volts. Use the terminal marked "230V" for power supplies between 220 and 240 volts. Inspect Control board, visually inspect Resistor R185, (located next to AC Input connector.) if this resistor appears burnt replace the control board after voltage issue to the machine is corrected.
TEMP SENSOR SHORT	
Condition	This error occurs when the control detects a short circuit from the temperature sensor.
Control Action	When detected, the control turns off the motor and the heating relay. There is no delay in the action once the criteria are met.
Exit	The machine will not start and the Error Code will continue to be displayed until the condition is no longer present. Once the condition is removed, the machine still will not start and the Error Code will continue to be displayed until the prompt is followed to Reset the Error and return the machine to Idle Mode.
Customer Action	Inspect temp probe wires. Ohm test temp probe 10K Ohms at room temp.
TEMP SENSOR OPEN	
Condition	This error occurs when the control detects an open circuit from the temperature sensor.
Control Action	When detected, the control turns off the motor and the heating relay. There is no delay in the action once the criteria are met.
Exit	The machine will not start and the Error Code will continue to be displayed until the condition is no longer present. Once the condition is removed, the machine still will not start and the Error Code will continue to be displayed until the prompt is followed to Reset the Error and return the machine to Idle Mode.
Customer Action	Inspect temp probe wires. Ohm test temp probe 10K Ohms at room temp.
Customer Action	Inspect temp probe wires. Ohm test temp probe 10K Ohms at room temp.

NO HEAT RISE	
Condition	This error occurs when the control detects that the temperature is not increasing.
Control Action	When detected there is a delay of 15 minutes before the error is active. Once active, the control will display the "NO HEAT RISE" prompt, alternating with the normal Cycle Progress screen at a rate of 5 seconds on, 5 seconds off. The heating relay will also be turned off. Otherwise the cycle will continue normally.
Exit	The Error Code will continue to be displayed until the in-progress cycle is stopped and the control is returned to Idle Mode. It will then reset automatically.
Customer Action	Test Safty's, High Limit, air flow switch, and overtemp thermostat.
HEAT RISE OUT OF RANGE	
Condition	This error occurs when the control detects that the operating temperature is greater than 220 degrees F (or 104 degrees C).
Control Action	When detected, the control will display the "HEAT RISE OUT OF RANGE" prompt, alternating with the normal Cycle Progress screen at a rate of 5 seconds on, 5 seconds off. The heating relay will also be turned off. Otherwise the cycle will continue normally. There is no delay in the action once the criteria are met.
Exit	The Error Code will continue to be displayed until the in-progress cycle is stopped and the control is returned to Idle Mode. It will then reset automatically.
Customer Action	Inspect temp probe and connections. Ohm test temp probe 10K Ohms at room temp.
NO PROX SENSOR OUTPUT	
Condition	This error occurs when the machine control does not detect output from the proximity sensor(s) when the cylinder has been commanded to turn.
Control Action	When detected, there is a short delay before the error is active. When active, the control turns off the motor and the heating relay.
Exit	The machine will not start and the Error Code will continue to be displayed until the prompt is followed to Reset the Error Code and return the Machine to Idle Mode.
Customer Action	Inspect gap on sensor. Update firmware to latest rev.
PROX SENSOR OUT OF RANGE	
Condition	This error occurs when the machine control sees output from the proximity sensor(s) that does not fall in the acceptable range for the particular washer or dryer model running at normal speeds. It also occurs when the machine control sees output from the proximity sensor that implies the tumbler is still turning when the control has commanded it to stop.
Control Action	When detected, there is a short delay before the error is active. When active, the control turns off the motor and the heating relay.
Exit	The machine will not start and the Error Code will continue to be displayed until the prompt is followed to Reset the Error Code and return the Machine to Idle Mode.
Customer Action	Inspect gap on sensor. Update firmware to latest rev.

CONTROL BOARD	
Condition	This error occurs when the Main Control Board cannot command the input and outputs of the control system as required by the cycle programming.
Control Action	When detected, the control turns off the motor and the heating relay. There is no delay in the action once the criteria are met.
Exit	The machine will not start and the Error Code will continue to be displayed until the prompt is followed to Reset the Error Code and return the Machine to Idle Mode. If the prompt to Reset is not available, power must be cycled to the machine to reset the error.
Customer Action	
GRAPHICS BOARD	
Condition	This error occurs when the Graphics Board cannot command the Main Control board as required by the cycle programming.
Control Action	When detected, the control turns off the motor and the heating relay. There is no delay in the action once the criteria are met.
Exit	The machine will not start and the Error Code will continue to be displayed until the prompt is followed to Reset the Error Code and return the Machine to Idle Mode. If the prompt to Reset is not available, power must be cycled to the machine to reset the error.
Customer Action	
MODEL JUMPER MISSING	
Condition	This error occurs when there is no connection to Ground (Pin 7) on the Model Jumper Header.
Control Action	When detected, the control turns off the motor and the heating relay. There is no delay in the action once the criteria are met. The machine control checks for this condition when power is cycled and before starting every machine cycle.
Exit	The machine will not start and the Error Code will continue to be displayed until the condition no longer exists and the prompt is followed to Reset the Error Code and return the Machine to Idle Mode.
Customer Action	Inspect and reseal Model Jumper harness at J6. Perform Soft reset holding down both Reset button and Button 1 on the control board. release reset button continue to hold button 1 until display appears.
MODEL JUMPER CHANGED	
Condition	This error occurs when the jumper connections to Ground (Pin 7) on the Model Jumper Header have changed since the last control check.
Control Action	When detected, the control turns off the motor and the heating relay. There is no delay in the action once the criteria are met. The machine control checks for this condition when power is cycled and before starting every machine cycle.
Exit	The machine will not start and the Error Code will continue to be displayed until the condition no longer exists and the prompt is followed to Reset the Error Code and return the Machine to Idle Mode.
Customer Action	If someone has been doing repairs on the washer, check for the correct size drive. Inspect and reseal Model Jumper harness at J6. Perform Soft reset holding down both Reset button and Button 1 on the control board. release reset button continue to hold button 1 until display appears.

MODEL JUMPER / DRIVE SIZE	
Condition	This error occurs when the jumper connections to Ground (Pin 7) on the Model Jumper Header do not match the VFD size code.
Control Action	When detected, the control turns off the motor and the heating relay. There is no delay in the action once the criteria are met. The machine control checks for this condition when power is cycled and before starting every machine cycle.
Exit	The machine will not start and the Error Code will continue to be displayed until the condition no longer exists and the prompt is followed to Reset the Error Code and return the Machine to Idle Mode.
Customer Action	If someone has been doing repairs on the washer, check for the correct size drive. Inspect and reseal Model Jumper harness at J6. Perform Soft reset holding down both Reset button and Button 1 on the control board. release reset button continue to hold button 1 until display appears.
MODEL JUMPER / DRIVE PARAMETER	
Condition	This error occurs when the jumper connections to Ground (Pin 7) on the Model Jumper Header do not match the VFD parameters being used.
Control Action	When detected, the control turns off the motor and the heating relay. There is no delay in the action once the criteria are met. The machine control checks for this condition when power is cycled and before starting every machine cycle.
Exit	The machine will not start and the Error Code will continue to be displayed until the condition no longer exists and the prompt is followed to Reset the Error Code and return the Machine to Idle Mode.
Customer Action	If VFD replaced verify correct P/N, if control board replaced, make sure Model Jumper on J6. Perform Soft reset holding down both Reset button and Button 1 on the control board. release reset button continue to hold button 1 until display appears.
NON-DEXTER DRIVE	
Condition	This error occurs when a non-Dexter VFD is installed in the machine.
Control Action	When detected, the control turns off the motor and the heating relay. There is no delay in the action once the criteria are met. The machine control checks for this condition when power is cycled and before starting every machine cycle.
Exit	The machine will not start and the Error Code will continue to be displayed until the condition no longer exists and the prompt is followed to Reset the Error Code and return the Machine to Idle Mode.
Customer Action	Install or replace OEM VFD.
DRIVE OVERLOAD	
Condition	This error occurs when the control receives a message that the drive has experienced an overload condition.
Control Action	When detected, the control turns off the motor and the heating relay. There is no delay in the action once the criteria are met.
Exit	The machine will not start and the Error Code will continue to be displayed until the condition no longer exists and the prompt is followed to Reset the Error Code and return the Machine to Idle Mode.
Customer Action	

DRIVE OVERCURRENT	
Condition	This error occurs when the control receives a message that the drive has experienced an over current condition.
Control Action	When detected, the control turns off the motor and the heating relay. There is no delay in the action once the criteria are met.
Exit	The machine will not start and the Error Code will continue to be displayed until the condition no longer exists and the prompt is followed to Reset the Error Code and return the Machine to Idle Mode.
Customer Action	Step 1: Check to make sure the Dryer cylinder turns freely by hand. If it turns freely, continue to step 2. If it does not, remove the belt and see if the motor turns freely by hand. If the motor turns freely, then check for obstructions in the cylinder or check the bearings. If the motor does not turn freely, replace the motor. Step 2: Check the motor wires for a short circuit between leads. If there are motor leads that have conductors touching, separate them and insulate them. If the wires are broken, splice them together or replace the motor. Step 3: Check braking resistors to see if they measure the correct resistance. If a resistor does not measure the proper value, replace it.
DRIVE GROUND FAULT	
Condition	This error occurs when the control receives a message that the drive has experienced a ground fault condition.
Control Action	When detected, the control turns off the motor and the heating relay. There is no delay in the action once the criteria are met.
Exit	The machine will not start and the Error Code will continue to be displayed until the condition no longer exists and the prompt is followed to Reset the Error Code and return the Machine to Idle Mode.
Customer Action	Inspect Door switch harnesses, replace loading door and lint door switches. Inspect motor harnesses for damage.
DRIVE LOW VOLTAGE	
Condition	This error occurs when the control receives a message that the drive has experienced a low voltage condition.
Control Action	When detected, the control turns off the motor and the heating relay. There is no delay in the action once the criteria are met.
Exit	The machine will not start and the Error Code will continue to be displayed until the condition no longer exists and the prompt is followed to Reset the Error Code and return the Machine to Idle Mode.
Customer Action	Measure incoming line voltage at VFD, . Turn the power off to the washer. Check the wiring connections to the drive and motor. If no problem is observed, turn on power to the washer and test. If voltage correct replace VFD

DRIVE INTERNAL	
Condition	This error occurs when the control receives a message that the drive has experienced an internal error.
Control Action	When detected, the control turns off the motor and the heating relay. There is no delay in the action once the criteria are met.
Exit	The machine will not start and the Error Code will continue to be displayed until the condition no longer exists and the prompt is followed to Reset the Error Code and return the Machine to Idle Mode.
Customer Action	Turn the power off to the washer. Wait one minute. Turn the power on to the washer. If problem reappears, contact your Dexter representative.
DRIVE EXCEPTION	
Condition	This error occurs when the control receives a message that the drive has logged an exception code.
Control Action	When detected, the control turns off the motor and the heating relay. There is no delay in the action once the criteria are met.
Exit	The machine will not start and the Error Code will continue to be displayed until the condition no longer exists and the prompt is followed to Reset the Error Code and return the Machine to Idle Mode.
Customer Action	
AUTODRY OOR LOW	
Condition	This error occurs when the machine control sees output from the RMC sensor (secondary) board that is out-of-range at 0V or lower.
Control Action	When detected there is a delay of 5 minutes before the error is active. Once active, the control will display the "AUTODRY OOR LOW" prompt and the current drying stage will end. The next stage will begin and the error will continue to be displayed alternating with the Cycle Progress screen during the remainder of the stage.
Exit	The Error Code will continue to be displayed until the cycle is stopped and the control is returned to Idle mode.
Customer Action	

DRIVE COMMUNICATION	
Condition	This error occurs the control cannot communicate with the VFD.
Control Action	When detected, the control turns off the motor and the heating relay. There is no delay in the action once the criteria are met
Exit	The machine will not start and the Error Code will continue to be displayed until the condition no longer exists and the prompt is followed to Reset the Error Code and return the Machine to Idle Mode.
Customer Action	Inspect Drive code before powering down. Inspect Data communication Cable between Drive and control board. replace Data cable.
DRIVE ENABLE	
Condition	This error occurs when the control sees a message that the VFD Enable circuit is not closed.
Control Action	When detected, the control turns off the motor and the heating relay. There is no delay in the action once the criteria are met.
Exit	The machine will not start and the Error Code will continue to be displayed until the condition no longer exists and the prompt is followed to Reset the Error Code and return the Machine to Idle Mode.
Customer Action	Inspect yellow wires to Drive DCM & MI6
OUT OF SERVICE	
Condition	This error occurs when the user has designated that the machine control should be made inoperable.
Control Action	When detected, the control turns off the motor and the heating relay. There is no delay in the action once the criteria are met.
Exit	The machine will not start and the Error Code will continue to be displayed the user changes the Out of Service state.
Customer Action	The User will have to go into management Settings to put back in service.
AUTODRY COMMUNICATION 1	
Condition	This error occurs when the machine control does not detect CAN communication from the RMC stationary (primary) board.
Control Action	When detected, there is a delay of 30 seconds before the error is active. When active, the control will display the "AUTODRY COMMUNICATION 1" prompt and the current drying stage will end. AutoDry Communication Error 1 will alternate on the display for 5 seconds on, then 5 seconds off continuously until the end of the drying cycle which continues as normal. The error occurs within 5 seconds of a CAN communication malfunction. Eventually, if CAN communications are missing for 5 minutes, AutoDry communication Error 2 will be displayed
Exit	The Error Code will continue to be displayed until the cycle is stopped and the control is returned to Idle mode.
Customer Action	Check harness between control and stationary board for damage, if yes replace. Check the distance between the RMC stationary and rotating boards to ensure a 3/16" gap between them. Re-synchronise RMC Boards. Next Test for Voltage on CAN connector, Green is ground, Red 12Vdc, Yellow 24Vdc.

AUTODRY COMMUNICATION 2	
Condition	AutoDry Communication Error 2 is caused when there is a fault in the wireless communication between the RMC stationary and rotating board. AutoDry Communication Error 2 can also be caused by a loss of sync between the RMC stationary and rotating boards. See RMC Sync slides for more information. A loss of sync is not typical unless a new RMC stationary or rotating board has been installed.
Control Action	When the RMC stationary board tries to send/receive communication to/from the rotating board and fails, it will reboot. After 5 minutes of failed attempts of communicating, AutoDry Communication Error 2 is displayed. If the CAN bus is not functioning to allow communication between the RMC stationary board and the control board, then AutoDry Communication Error 2 will appear after AutoDry Communication Error 1 has been displayed.
Exit	The Error Code will continue to be displayed until the cycle is stopped and the control is returned to Idle mode.
Customer Action	Inspect harness between control and stationary board for damage, if yes replace. Check the distance between the RMC stationary and rotating boards to ensure a 3/16" gap between them. Re-synchronise RMC Boards. Next Test for Voltage on CAN connector, Green is ground, Red 12Vdc, Yellow 24Vdc.
AUTODRY COMMUNICATION 3	
Condition	AutoDry Communication Error 3 is caused by 5 minutes of faulty data being transmitted between the RMC stationary and rotating boards. Data is being transmitted, but likely the charging coils in the RMC stationary and rotating boards are too far apart to sufficiently power the RMC rotating board and collect a voltage reading from the sensor strip.
Control Action	When detected, there is a delay of 30 seconds before the error is active. When active, the control will display the "AUTODRY COMMUNICATION 3" prompt and the current drying stage will end. The next stage will begin and the error will continue to be displayed alternating with the Cycle Progress screen during the remainder of the stage.
Exit	The Error Code will continue to be displayed until the cycle is stopped and the control is returned to Idle mode.
Customer Action	Check the distance between the RMC stationary and rotating boards to ensure a 3/16" gap between them. See Service Procedures

OVER TEMPERATURE DETECTED	
Condition	This error occurs when an overheat condition has been detected at the OHP sensor
Control Action	When detected there is a calculated delay before the error is active. Once active, the control turns off the heating relays, the control buzzer is turned on, and the alarm relay closes. After 5 seconds, tumbler rotation may occur. If the dryer is equipped with a Fire Suppression system, water may be injected into the dryer cylinder.
Exit	The Error Code will continue to be displayed until the condition is no longer present and the mechanical Reset button is pressed on the Main Control board.
Customer Action	If a true overheat has not occurred, Inspect for restricted exhaust Inspect Harness connection. Ohm Test Overheat temp probe 10K.
OVERHEAT SENSOR SHORT	
Condition	This error occurs when the control detects a short circuit from the overheat temperature sensor.
Control Action	When detected, the control turns off the motor and the heating relay. There is no delay in the action once the criteria are met.
Exit	The machine will not start and the Error Code will continue to be displayed until the condition is no longer present. Once the condition is removed, the machine still will not start and the Error Code will continue to be displayed until the prompt is followed to Reset the Error and return the machine to Idle Mode.
Customer Action	Inspect Harness connection. Ohm Test temp probe 10K
OVERHEAT SENSOR OPEN	
Condition	This error occurs when the control detects an open circuit from the overheat temperature sensor.
Control Action	When detected, the control turns off the motor and the heating relay. There is no delay in the action once the criteria are met.
Exit	The machine will not start and the Error Code will continue to be displayed until the condition is no longer present. Once the condition is removed, the machine still will not start and the Error Code will continue to be displayed until the prompt is followed to Reset the Error and return the machine to Idle Mode.
Customer Action	Inspect Harness connection. Ohm Test temp probe 10K

Close Door	
Condition	This Error occurs when the control detects that either the loading door or the Lint compartment door circuit is not closed
Control Action	When detected, the control will not allow the cycle to start. the display "Close Door" will stay present until the circuit is closed
Exit	When detected will not start until circuit is closed.
Customer Action	Inspect Door switched and wiring. Inspect lint door paddle make sure fully engaging lint door switch.
Control Board Error 11	
Condition	Model jumper not Selected or detected. Relay Board or control board.
Control Action	Error will display and cycle will stop.
Exit	The machine will not start and the Error Code will continue to be displayed until the condition no longer exists and the prompt is followed to Reset the Error Code and return the Machine to Idle Mode.
Customer Action	Inspect Model Jumper on Relay board (P3) make sure connected and present. Inspect I2C harness between control (Relay Exp.)and relay board (P1). Inspect for 12VO_SW LED make sure illuminated. If not test 12Vdc power supply, (must be 11.4 or above). Inspect harnesses if pinched or damaged (loading door and lint switch).
Control Board Error 66	
Condition	Model jumper not Selected or detected. Relay Board or control board.
Control Action	Error will display and cycle will stop.
Exit	The machine will not start and the Error Code will continue to be displayed until the condition no longer exists and the prompt is followed to Reset the Error Code and return the Machine to Idle Mode.
Customer Action	Inspect Model Jumper on Relay board (P3) make sure connected and present. Inspect I2C harness between control (Relay Exp.)and relay board (P1). Inspect for 12VO_SW LED make sure illuminated. If not test 12Vdc power supply, (must be 11.4 or above). Inspect harnesses if pinched or damaged (loading door and lint switch).
Control Board Error 68	
Condition	Model jumper not Selected or detected. Relay Board or control board.
Control Action	Error will display and cycle will stop.
Exit	The machine will not start and the Error Code will continue to be displayed until the condition no longer exists and the prompt is followed to Reset the Error Code and return the Machine to Idle Mode.
Customer Action	Inspect Model Jumper on Relay board (P3) make sure connected and present. Inspect I2C harness between control (Relay Exp.)and relay board (P1). Inspect for 12VO_SW LED make sure illuminated. If not test 12Vdc power supply, (must be 11.4 or above). Inspect harnesses if pinched or damaged (loading door and lint switch).

Control Board Error 82

Condition	Model jumper not Selected or detected. Relay Board or control board.
Control Action	Error will display and cycle will stop.
Exit	The machine will not start and the Error Code will continue to be displayed until the condition no longer exists and the prompt is followed to Reset the Error Code and return the Machine to Idle Mode.
Customer Action	Inspect Model Jumper on Relay board (P3) make sure connected and present. Inspect I2C harness between control (Relay Exp.) and relay board (P1). Inspect for 12VO_SW LED make sure illuminated. If not test 12Vdc power supply, (must be 11.4 or above). Inspect harnesses if pinched or damaged (loading door and lint switch).

Wiring Schematic -11

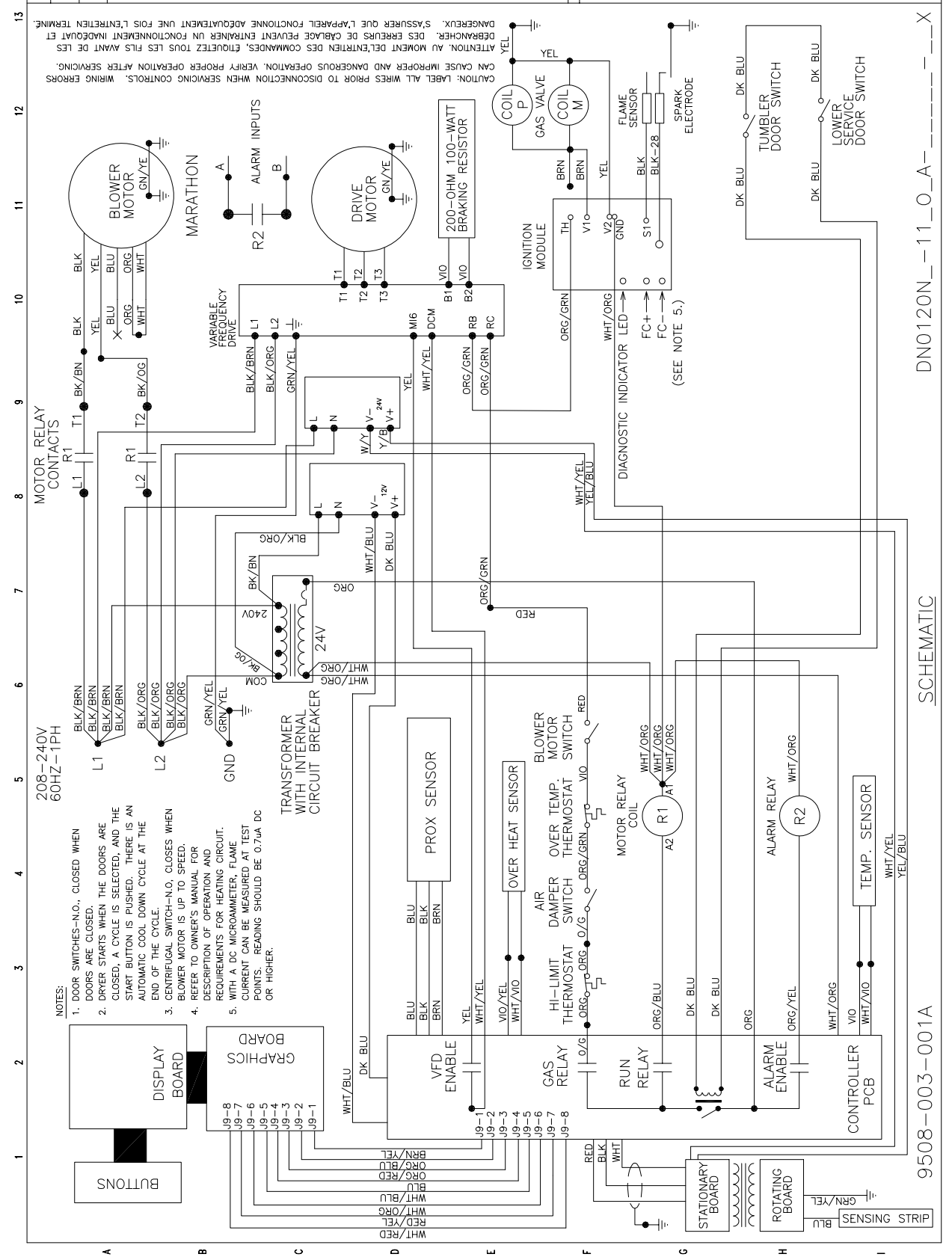

Kits, Assemblies, & Common Parts

Description	Part Number
Kit – Add Water Option	9732-358-004
Kit Replacement for 9376-317-005	9732-357-001
Kit, Optional Replacement for Round Switch 9539-492-001	9732-351-001
Temperature Probe	9501-004-004
Controls	9799-027-001
Overtemp Thermostat	9576-207-006
Lint Screen Assembly	9822-033-001
Door Switch (Round)	9539-492-001
Door Switch (Square)	9539-501-001
Ignition Control Assembly	9857-182-001
Electrode Assembly	9875-002-003
Hi-Limit Thermostat	9576-203-002
Relay	5192-285-004
Transformer	8711-007-002
Airflow Switch	9539-461-009
Door Handle	9244-093-001
Spider/Trunnion	9568-016-001
Motor Belt	9040-076-008
Tumbler Belt	9040-076-005
Gap Tool	8545-065-001



Section 5: Dryer Parts Data

DN0120ND-11E01A
DN0120ND-10E01A

Dryer Cabinet Front Panel

Key	Description	T-120	
*	Loading Door Complete Wht/SS/Blk	9960-311-003	1
1	Door Assy, Loading (Ring only) SS	9960-330-001	1
2	Plate Assy, Hinge (Wht)	9982-398-003	1
*	Cover-Hinge Back, Black	9074-340-002	1
*	Screw-10Bx3/8, Black	9545-008-010	2
*	Screw Hinge to Door	9545-018-018	4
*	Nut, Hinge to Door	8640-414-006	4
3	Glass, Door	9212-002-006	1
4	Gasket, Door Glass (Black)	9206-413-002	1
*	Support Door Glass	9545-117-000	2
5	Gasket, Door Outer Rim (Black)	9206-420-007	1
6	Handle, Loading Door	9244-093-001	1
*	Screw, Handle	9545-018-017	2
7	Stud Door Catch 7/8"	9531-033-002	1
8	Nut-Hex, #10-32	8640-413-001	1
9	Nut, Acorn	8640-413-003	1
*	Catch, Loading Door	9086-015-002	2
*	Rivet	9491-009-004	2
10	Strap, Hinge (Black)	9966-014-002	1
*	Channel Assy.-Front Panel	9947-024-001	1
*	Screw-Phillips, 10-32x1/2 Chrome	9545-012-028	4
*	Screw-Phillips-Counter sink, 10-32x1/2 Chrome	9545-012-003	2
11	Screw-Special, Hinge to Door	9545-052-001	1
*	Nut-Allen, 1/4-20	8640-439-001	1
12	Washer-Fiber/Plastic	8641-436-006	1
13	Front Panel Assy (Wht) Round	9989-688-008	1
13	Front Panel Assy (Wht) Square	9444-012-003	1
14	Screw-Phillips, 10Bx1 3/4	9545-008-014	10
15	Washer-Finish	8641-585-001	10
*	Nut-Spring	8640-399-001	10
16	Screw-Torx, 10AB x 3/4", White "T-20"	9545-008-035	8
*	Insulation-Front Panel	9277-065-001	1
*	Label-Warning	8502-758-001	1
18	Plug-Front Panel, Optional Door Switch Location (Round)	9456-050-001	1
18	Plug-Front Panel, Optional Door Switch Location (Square)	9456-055-001	1
*	Switch-Door Closed	9539-492-001	1
*	Wire-Assy-Blu, 23"	8220-063-049	1
19	Plug, 1/4", Locking	9456-051-001	6
*	Plug-2"	9456-041-009	1
21	Box-Control	9041-107-002	1
*	Cabinet Touch Up Paint (White)	9472-001-013	1

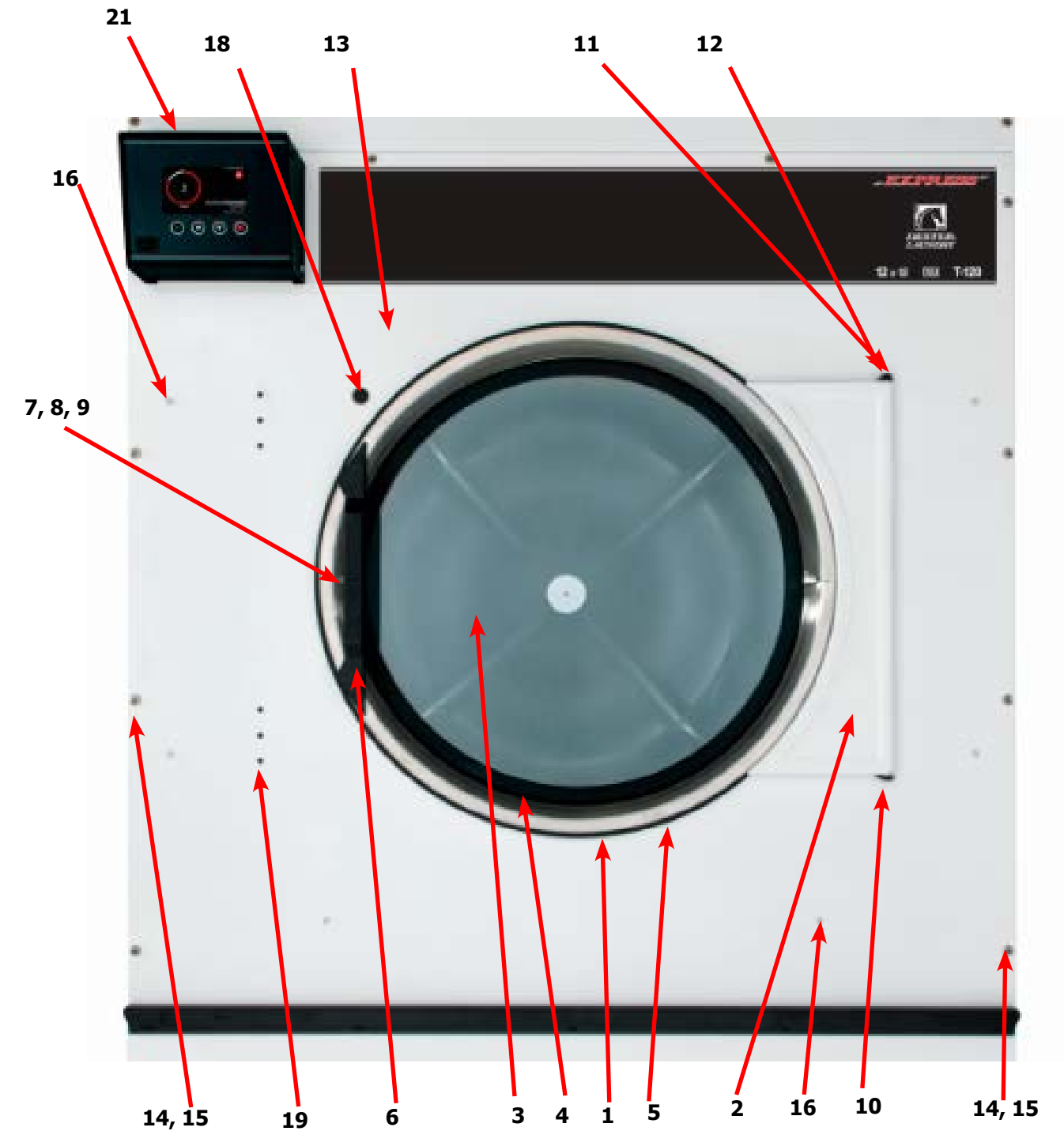

Dryer Cabinet Group Continued

Key	Description	T-120	QTY
*	Door Assy-Upper, OPL (Wht)	9960-328-004	1
*	Screw-Phillips, 10Bx1 3/4	9545-008-014	4
*	Washer-Finish	8641-585-001	4
*	Nut-Spring	8640-399-001	4
5	Box-Control Front, Black	9041-107-002	1
6	Screw-10ABx3/8	9545-008-024	4
*	Screw-10-32 x 1/2, Chrome	9545-012-003	2
8	Plate Assembly-Meter, Black	9982-394-002	1
9	Nut-Elastic Stop, #10-32	8640-413-004	2
11	Display Control	9857-230-002	1
12	Nut, #6-32	8640-411-003	3
14	Nut, #6-32	8641-411-003	1
15	Screw, #10-32 x1/2 Green	9545-008-027	1
16	Lock Washer #10	8641-582-006	1
19	Screw Torx-6BSD x 1/2, BLK, "T10"	9545-031-009	2
20	Harness-Display Control	9627-922-001	1
*	Harness-Temp Probe	9627-917-002	1
22	Plug-2"	9456-041-009	1
23	PCB Assy. Main Control	9799-027-001	1
24	Plate Assy. - Control Board	9982-395-001	1
25	PCB Assy. - Control Board (Only)	9474-003-001	1
26	Screw - panhdc, #6-32 x 1/2 (SS)	9545-044-010	6
27	Lockwasher - exttooth, #6	8641-582-005	6

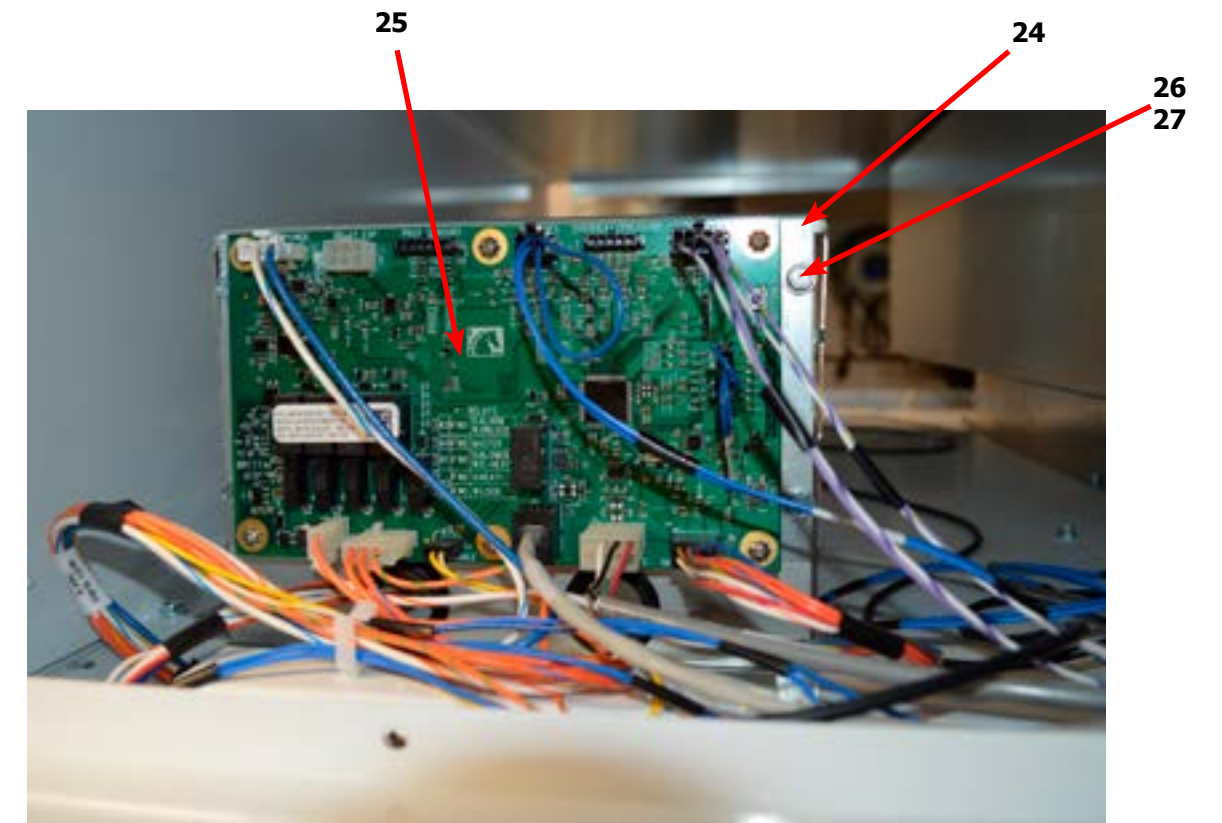
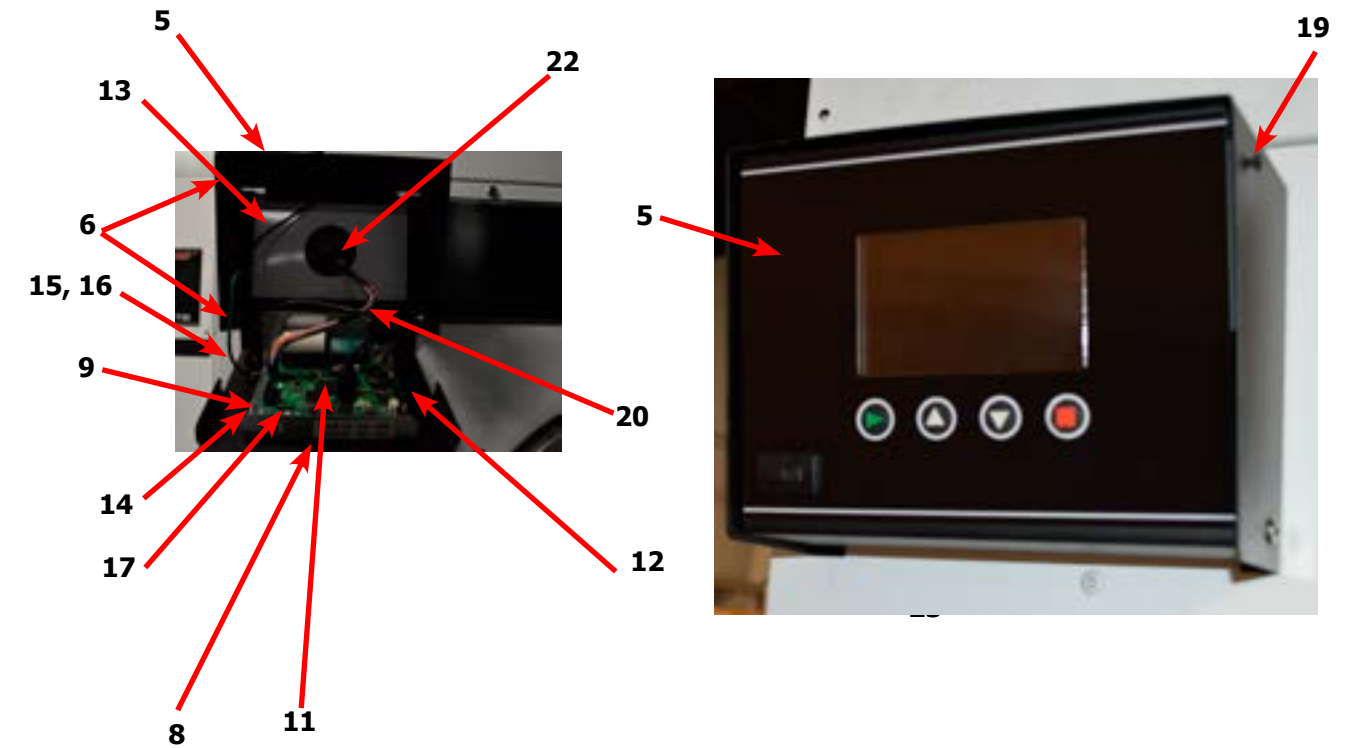

Dryer Cabinet Group Continued

Key	Description	T-120	QTY
*	Assembly-Door-Lower Service, OPL, Wht (Number 1 thru 14)	9960-307-001	1
1	Door-Lower Service, OPL, Wht	9960-324-006	1
2	Handle-Door, Lower Service, Black	9244-090-002	1
*	Screw-Phillips, 10Bx3/8, Black	9545-008-010	5
3	Handle,Turn-Door, Lower Service OPL	9244-084-002	2
4	Trim-Lower Kick, Black	9578-101-002	1
5	Screw-Phillips, 10Bx3/8, Black	9545-008-010	5
6	Bracket, Lower Service, (Hinge Bracket)	9029-233-001	2
7	Rivet, 1/8 Low Profile	9491-009-004	4
8	Nut, Elastic Stop, 10-32 UNF	8640-413-007	2
9	Arm, Lower Service, Right	9001-064-003	1
10	Screw. 10-32 x 1/2"	9545-012-003	1
11	Arm, Lower Service, Left	9001-064-004	1
*	Screw. 10-32 x 1/2"	9545-012-003	1
12	Insulation	9277-059-001	1
13	Bracket-Door Switch	9029-226-001	2
14	Rivet, 1/8 Low Profile	9491-009-004	4
15	Switch-Door Closure (Round)	9539-492-001	2
*	Switch-Door Closure (Square)	9539-501-001	2
*	Kit, Optional Replacement for Round Switch 9539-492-001	9732-351-001	1
16	Hinge-Door, Lower	9243-084-002	1
17	Screw- 10ABx3/8	9545-008-024	5
18	Screen Assy, Lint	9822-033-001	1
*	Footing Foot	9188-016-001	4

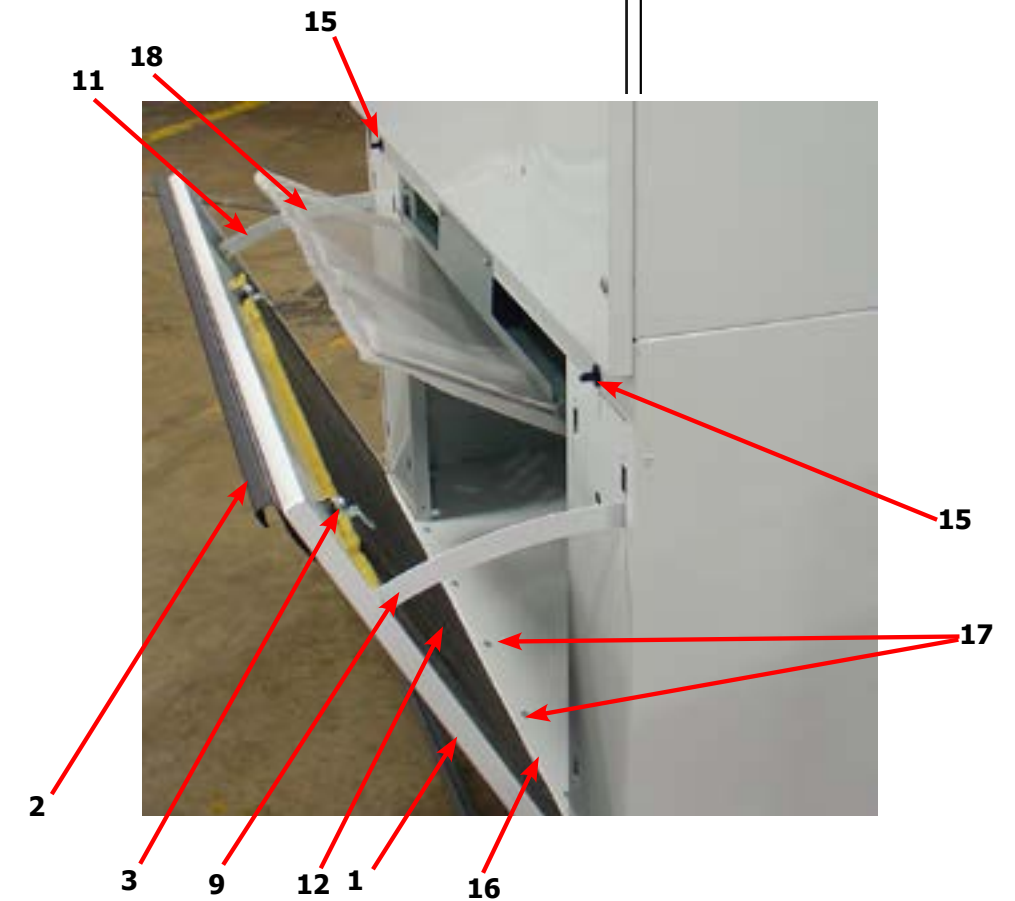
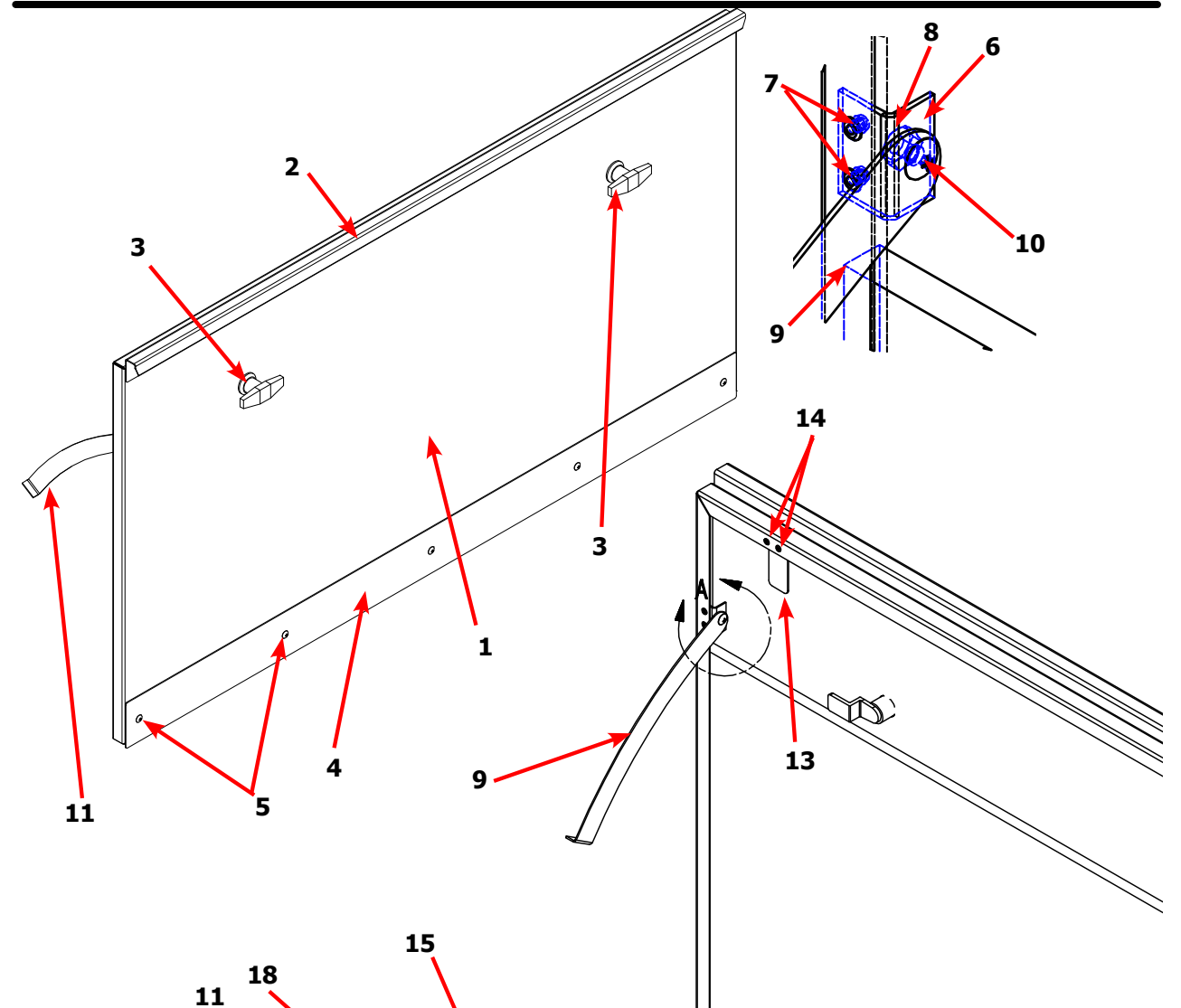

Dryer Cabinet Group Continued

Key	Description	T-120	QTY
1	Panel Assy.-Upper Right	9989-549-002	1
*	Screw, #10ABx1/2	9545-008-024	2
2	Insulation-Right Upper, Burner Area	9277-041-022	1
3	Panel Assy.-Upper Left	9989-550-002	1
*	Screw, #10ABx1/2	9545-008-024	2
4	Insulation Tumbler Area, Right (Front & Back)	9277-051-005	2
4	Insulation Tumbler Area, Right (Center)	9277-051-006	1
5	Insulation Tumbler Area, Left (Front & Back)	9277-051-005	2
5	Insulation Tumbler Area, Left (Center)	9277-051-006	1
6	Switch-Door Closure (Circular)	9539-492-001	2
*	Switch-Door Closure (Square)	9539-501-001	2
*	Screen Assy, Lint	9822-033-001	1
*	Lint Hood Assembly	9834-012-001	1
7	Lint Hood, Top & Sides	9240-048-001	1
8	Lint Hood, Bottom	9058-030-001	1
9	Lint Hood, Angle	9003-333-001	1
10	Screw,- 10ABx3/8	9545-008-024	21
11	Hinge-Door, Lower	9243-083-002	1
*	Screw-10ABx3/8	9545-008-024	5
12	Impeller, w/set screws	9278-041-001	1
13	Harness -Temp Probe	9627-917-002	1
14	Wire Nut, #71B	8640-276-005	2
15	Temp Probe	9501-004-004	1
16	Screw-Phillips, 8Bx1/4	9545-045-005	1
17	Bracket, Temp Probe	9029-111-001	1
18	Screw, 8AB x 3/8	9545-045-008	2
19	Trim-Edge, Lint Hood	9578-092-003	2

120Lb. Temp Probe

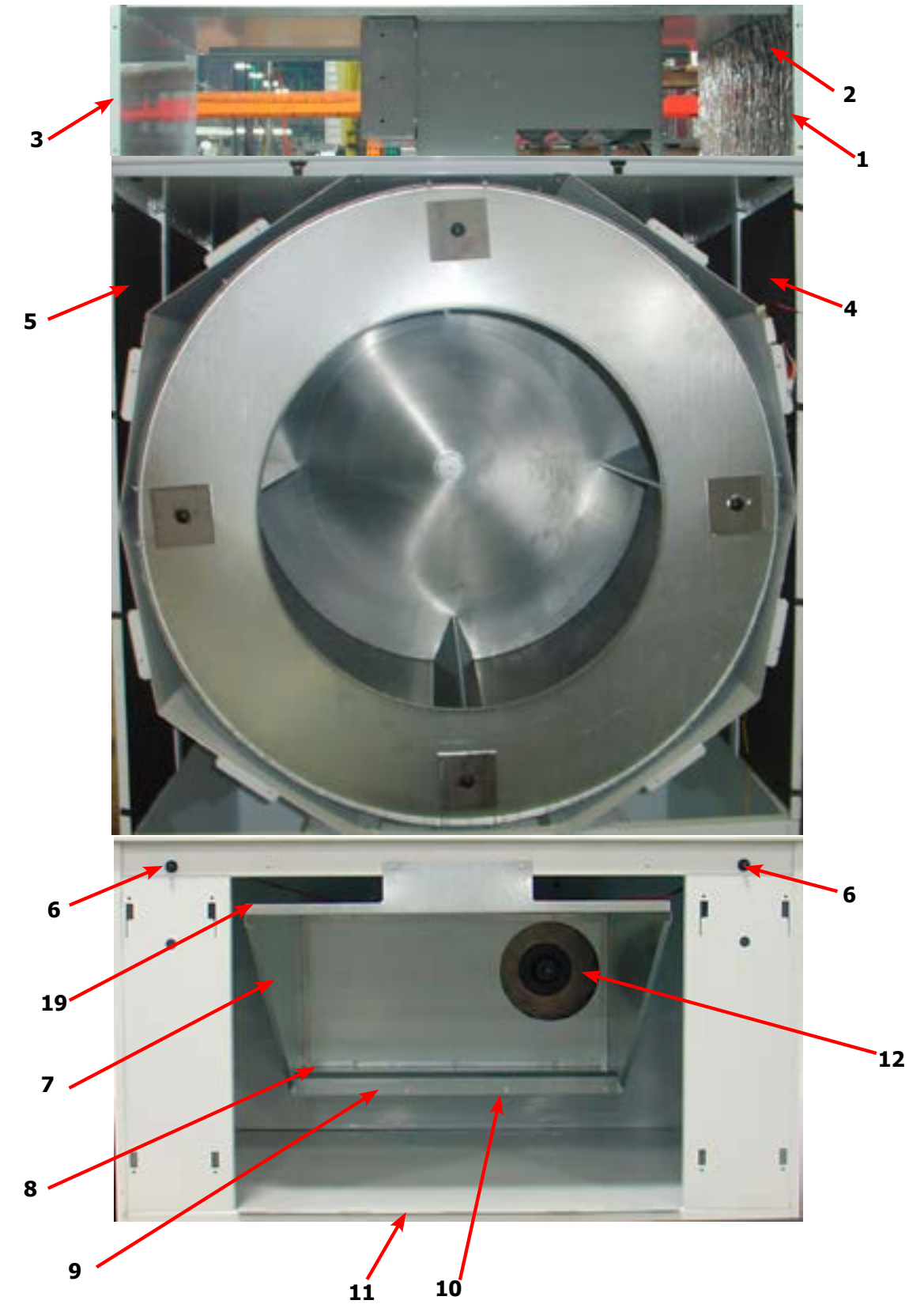
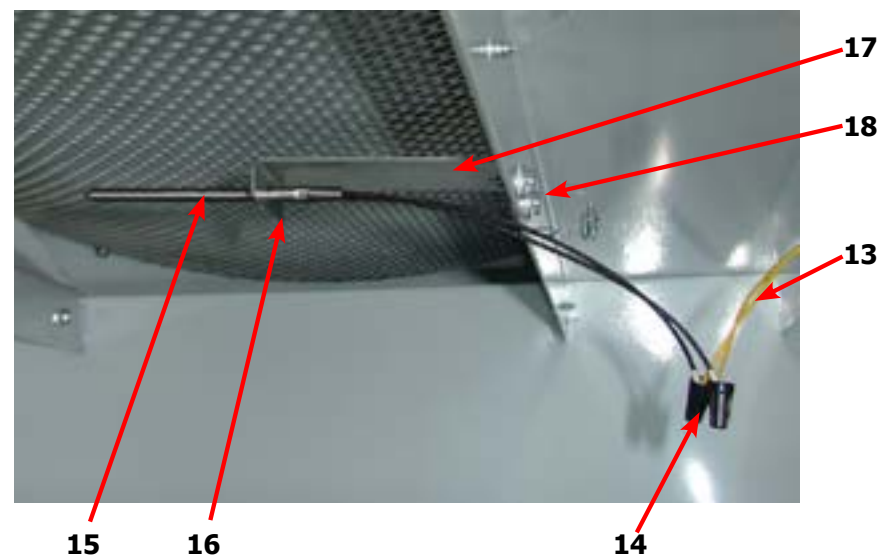

Dryer Modular Cabinet Group 120lb. (After Serial D1.23179.001)

Key	Description	T80	QTY
1	Cabinet Base Assembly	9945-172-001	1
*	Lower Back Panel Assembly	9989-754-002	1
2	Lower Cabinet RH Side Panel	9444-125-003	1
3	Lower Cabinet LH Side Panel	9444-125-004	1
4	Lower Cabinet Front Channel	9081-217-001	1
*	Upper Back Panel Assembly	9989-717-002	1
5	RH Middle Side Panel Assembly	9989-543-003	1
6	LH Middle Side Panel Assembly	9989-543-004	1
7	Cabinet Top Cover	9074-356-001	1
8	Baffle	9049-135-001	4
*	Baffle Stiffener Angle	9003-388-001	2
9	RH Upper Side Panel Assembly	9989-549-002	1
10	LH Upper Side Panel Assembly	9989-550-002	1
*	10abx3/8 Screw	9545-008-024	92
*	3/16 Blind Rivet	9491-009-001	131
*	Wht 3/16 Blind Rivet	9491-009-005	58
*	Hex kep Nut 1/4-20unc, 2b	8640-414-006	10

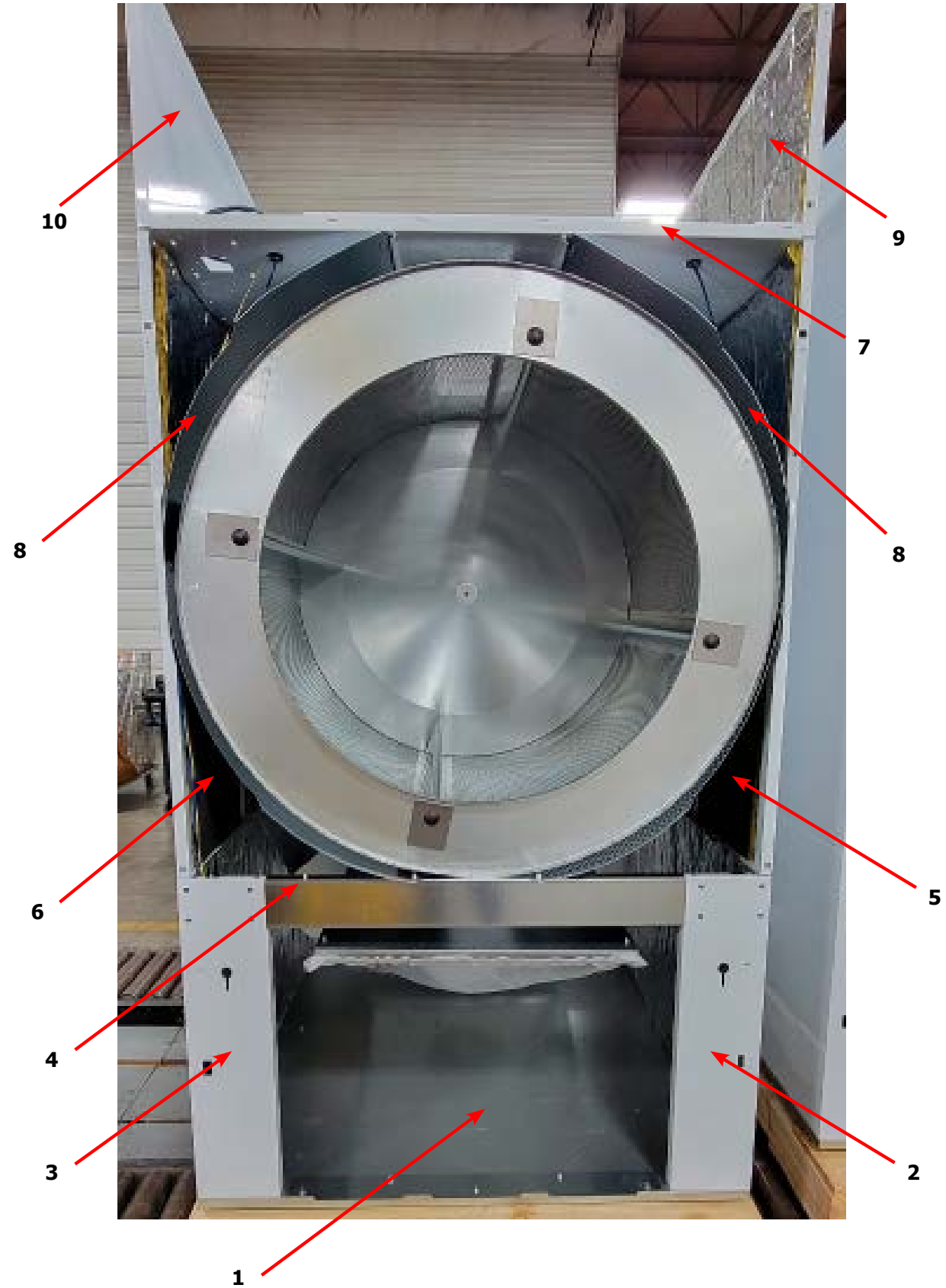

Dryer Rear View 120Lb Reversing

Key	Description	T-120	QTY
1	Pulley, Driven	9453-168-003	1
2	Tolerance Ring	9487-234-006	1
3	Washer -Flat	8641-581-032	1
4	LockWasher - IntTooth, 1"	8641-582-018	1
5	Screw, 5/8-11 x 1 1/2	9545-060-001	1
6	Belt-Driven	9040-076-005	2
*	Impeller, 5" x 16"	9278-041-001	1
7	Plate Assembly-Impeller	9982-375-002	1
8	Nut-Wiz Lock, 5/16-18	8640-400-003	6
*	Gasket-Impeller Housing	9206-428-002	1
9	Motor-Blower -10, Before Serial #D1.19254.036	9376-317-005	1
9	Motor-Blower -11, Before Serial #D1.19254.036	9376-334-001	1
9	Motor-Blower, -10 & -11, After Serial #D1.19254.036	9376-334-001	1
*	Run Capacitor	5191-108-005	1
*	Start Capacitor	5191-109-005	1
*	Screw, 5/16-18 x 5/8	9545-014-004	4
*	Nut-Wiz Lock, 5/16-18	8640-400-003	4
12	Thermostat-Overtemp	9576-207-006	1
*	Screw-10AB x 3/8	9545-008-006	2
14	Pulley, Intermediate, w/Bearings	9908-051-001	1
*	Bearings	9036-159-011	2
*	Spacer-Bearings	9538-186-001	1
*	Ring-Retaining, Internal	9487-238-006	1
15	Washer-Flat	8641-581-039	1
16	Nut, 5/8-11	8640-425-002	1
17	Belt, Motor	9040-076-008	1
18	Motor, Drive	9376-307-003	1
19	Pulley-Motor	9453-169-012	1
20	Bushing, Motor -Support	9053-074-002	2
21	Rod-Motor Mounting, Black	9497-222-008	1
22	Collar-Shaft, w/Set Screws	9076-052-002	1
23	Chain-Belt tension	9099-012-004	1
*	Hook-S Type	9248-022-002	1
24	Spring, Belt Tension	9534-151-000	1
*	Duct-Transition, 12" to 10"	9109-124-001	1

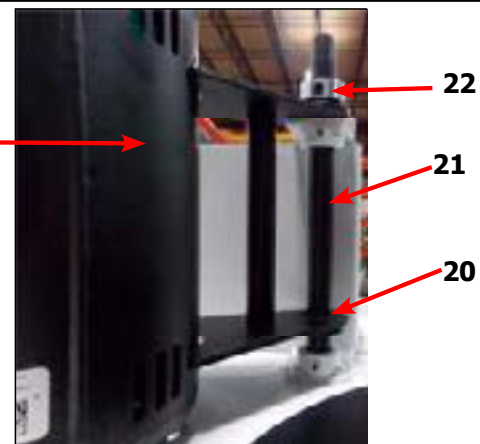
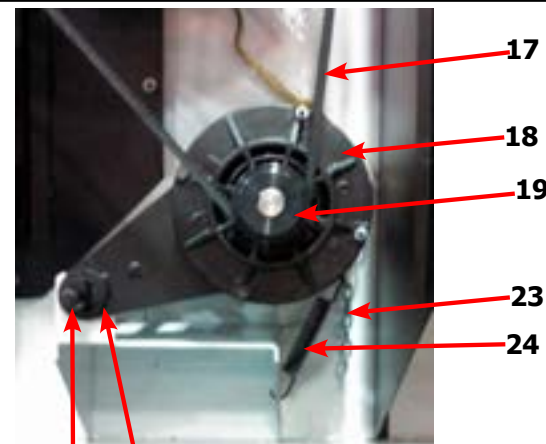

21 22

Dryer Rear View 120Lb Reversing

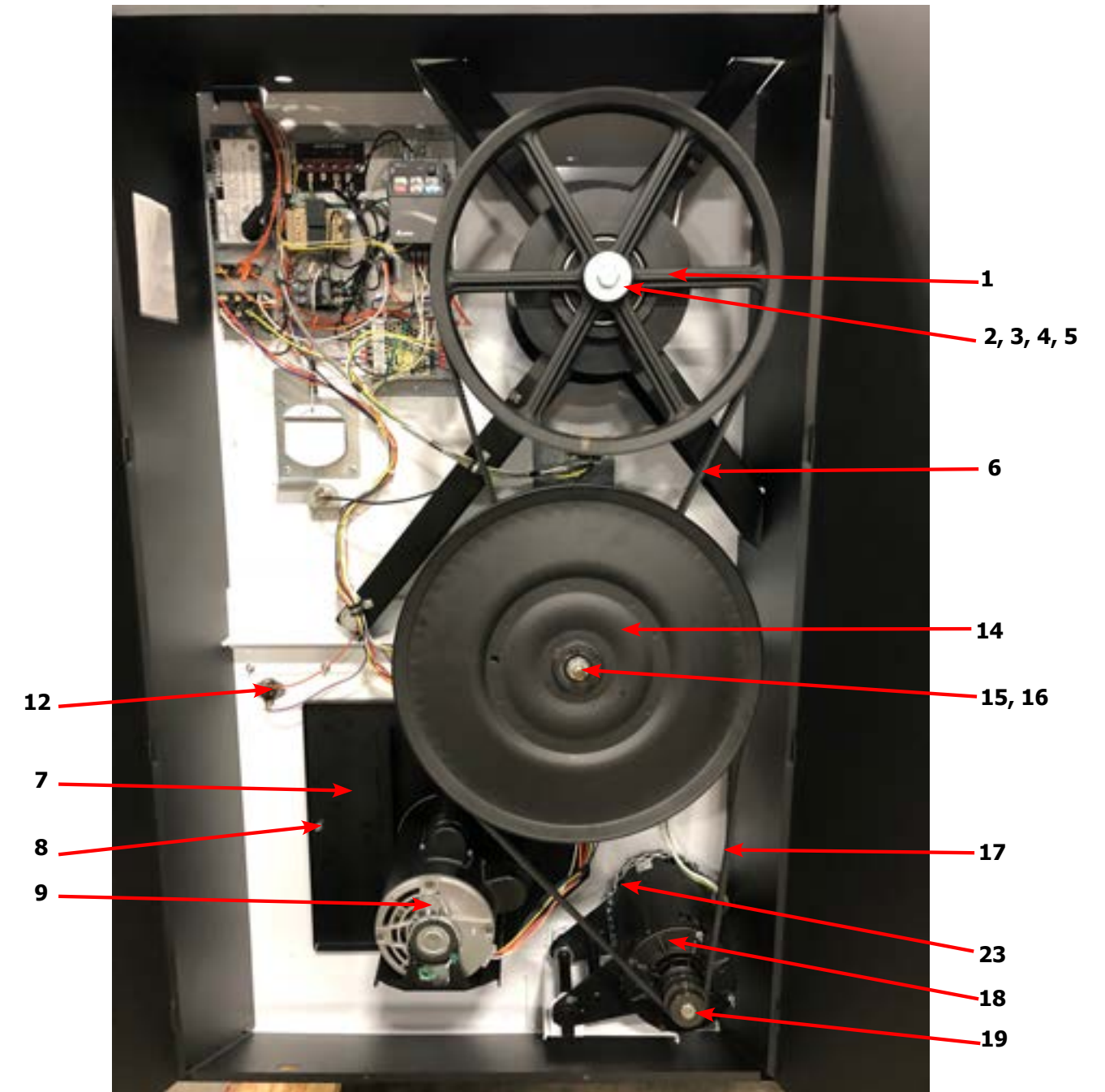

Dryer Rear View 120Lb Reversing Continued

Key	Description	T-120	QTY
6	Plate Assembly-Intermediate, Tension	9982-378-002	1
7	Rod-Intermediate, Pivot	9497-230-002	1
8	Collar, Locking	9076-060-001	1
9	Bolt, 1/2-13 x 1 1/2	9545-017-001	2
10	Thermostat-Overtemp	9576-207-006	1
11	Screw-10AB x 3/8	9545-008-006	2
*	Impeller, 5" x 16"	9278-041-001	1
12	Plate Assembly-Impeller	9982-375-002	1
13	Nut-Wiz Lock, 5/16-18	8640-400-003	6
*	Gasket-Impeller Housing	9206-428-002	1
14	Motor-Blower -10 Before Serial # D1.19254.036	9376-317-005	1
14	Motor-Blower -11 Before Serial # D1.19254.036	9376-334-001	1
14	Motor-Blower -11 & -10 After Serial # D1.19254.036	9376-334-001	1
*	Run Capicator	5191-108-005	1
*	Start Capicator	8191-109-005	1
15	Screw, 5/16-18 x 5/8	9545-014-004	4
16	Nut-Wiz Lock, 5/16-18	8640-400-003	4
17	Motor, Drive	9376-307-003	1
18	Pulley-Motor	9453-169-012	1
*	Bushing, Motor -Support	9053-074-002	2
19	Rod-Motor Mounting, Black	9497-222-008	1
20	Collar-Shaft, w/Set Screws	9076-052-002	1
21	Chain-Belt tension	9099-012-004	1
*	Hook-S Type	9248-022-002	1
*	Spring, Belt Tension	9534-151-000	1



7 8 6

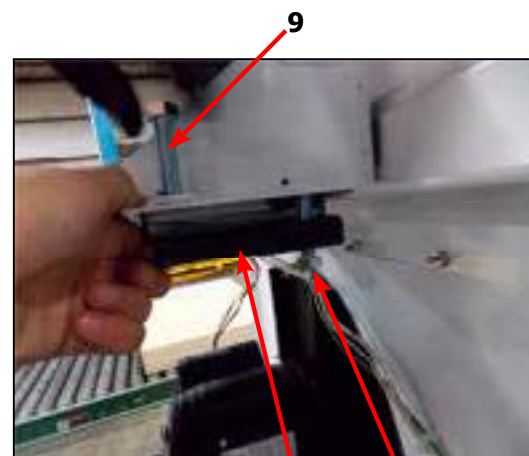

6 9

Dryer Rear View 120Lb Reversing Continued

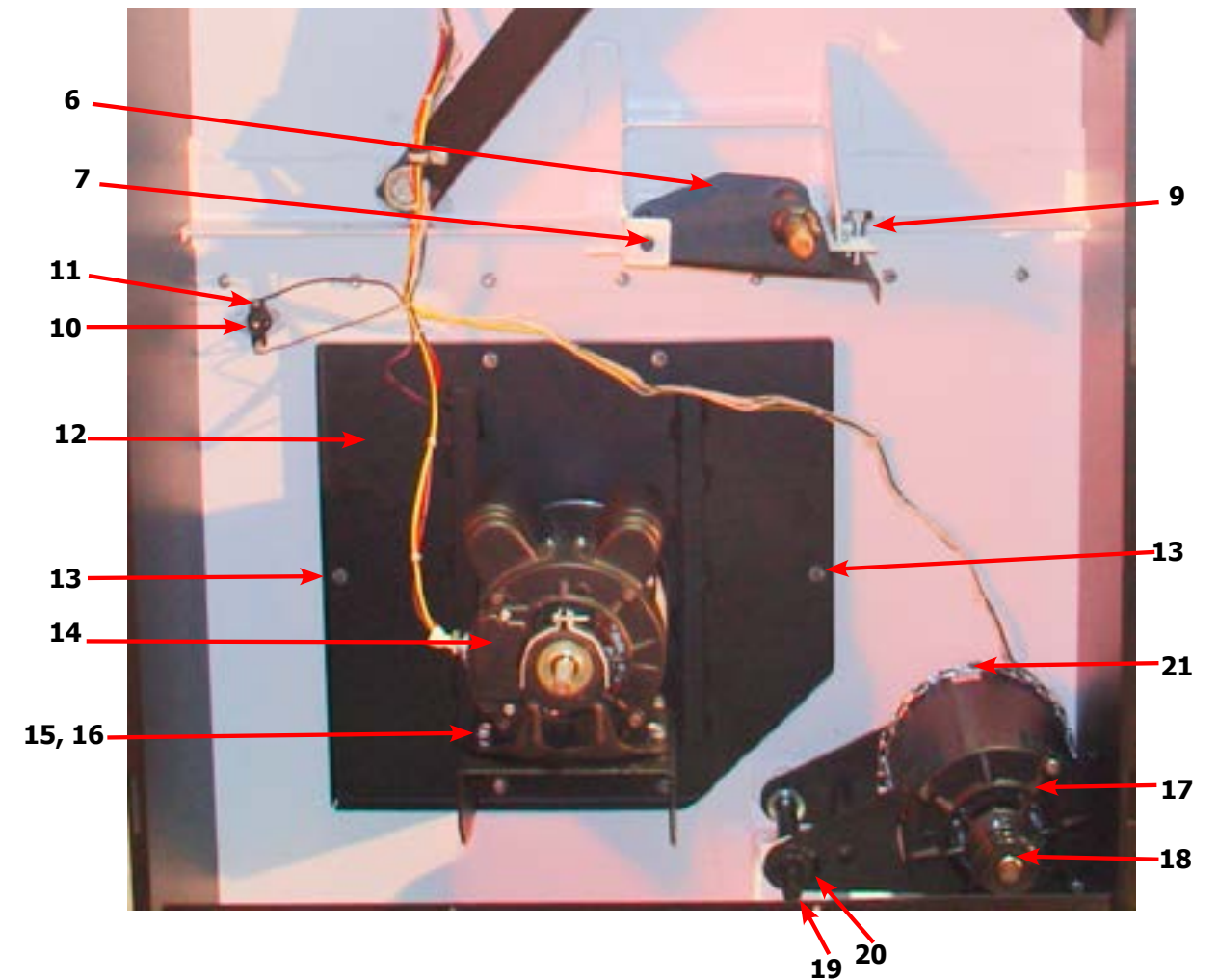

Dryer Rear View-Guard & Exhaust

Key	Description	T-120	QTY
1	Cover Cabinet	9074-356-001	1
*	Screw-5/16, 10ABx3/8	9545-008-024	16
2	Duct-Transition, 12" to 10"	9109-124-001	1
*	Screws-10-16 x 1/2	9545-008-003	3
*	Guard-Side, Right	9208-111-002	1
*	Screw-Torx T20, 10B x 3/8, BLK	9545-008-034	7
3	Guard-Side, Left	9208-110-002	1
*	Screw-Torx T20, 10B x 3/8, BLK	9545-008-034	8
4	Guard-Top	9208-112-002	1
*	Screw-Torx T20, 10B x 3/8, BLK	9545-008-034	11
5	Guard-Bottom	9208-113-002	1
*	Screw-Torx T20, 10B x 3/8, BLK	9545-008-034	6
6	Guard-Wires	9208-115-002	1
*	Screw-Torx T20, 10B x 3/8, BLK	9545-008-034	2
7	Guard-Door, Right	9208-114-004	1
*	Screw-Torx T20, 10B x 3/8, BLK	9545-008-034	6
8	Guard-Door, Left	9208-114-003	1
9	Screw-Torx T20, 10B x 3/8, BLK	9545-008-034	4
*	Nut-Spring, U-type	8640-399-001	4
*	Booklet-Owners	8514-291-001	1
10	Diagram -11	9507-003-001	1
10	Diagram -10	9507-048-001	
11	Label-Warning & Notice	8502-763-001	1
12	Label-Instructions	8502-645-001	1
13	Decal-Lighting & Clearance	8527-151-001	1
14	Label-High Voltage	8502-614-004	1

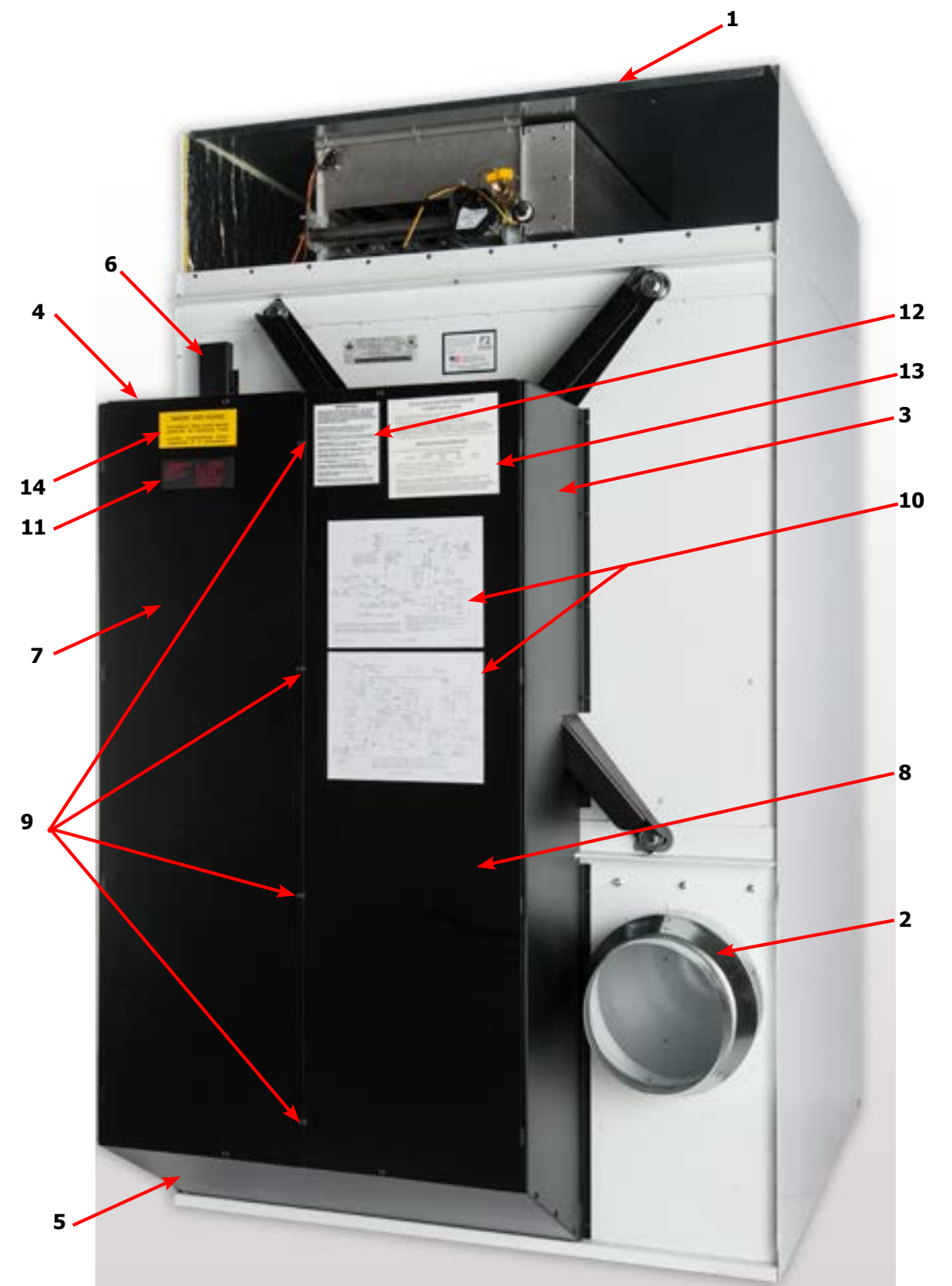

Dryer Rear View-Bearing Housing 120Lb

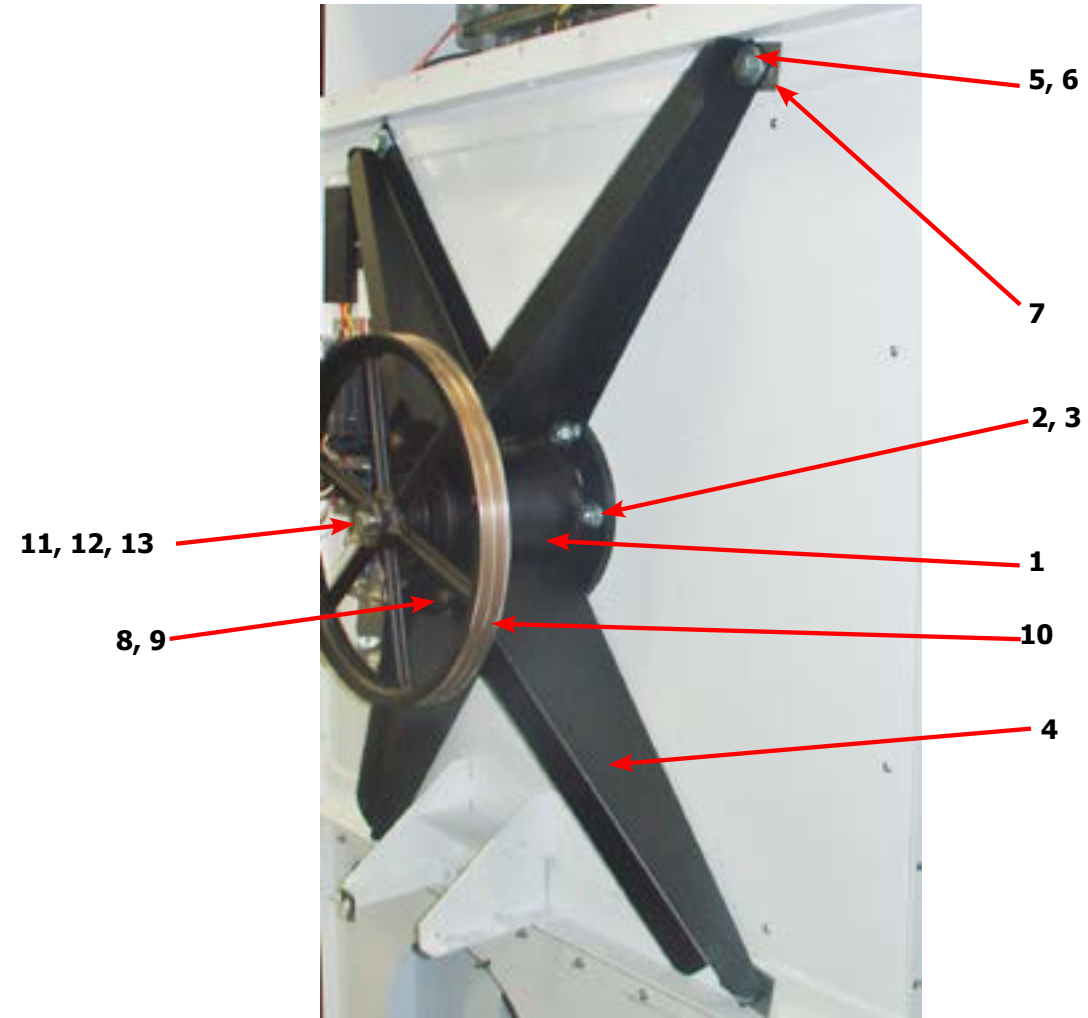

Key	Description	T-120	QTY
	Bearing Housing Complete Assy (Includes bearings & Spacer)	9803-186-001	1
1	Housing, Bearing	9241-180-002	1
*	Ring, Retaining-Internal	9487-238-003	1
*	Bearing, Ball, Front	9036-159-005	1
*	Spacer, Bearing	9538-167-001	1
*	Bearing, Ball, Rear	9036-159-004	1
*	Washer, Flat	8641-581-040	6
2	Screw-5/8"-11 x 1 1/2"	9545-060-001	6
3	Nut-Whizlock, 5/8" x 11	8640-425-001	6
4	Arm-Support Housing	9001-065-002	4
5	Screw-5/8-11 x 1 1/2	9545-060-001	4
6	Washer, Flat 5/8"	8641-581-038	4
7	Shim	9552-045-001	AR
8	Screw-7/16"-14 x 1 1/2"	9545-059-003	4
9	Nut-Whizlock, 7/16"	8640-416-005	4
*	Tolerance Ring	9487-234-006	1
10	Pulley Driven	9453-168-003	1
11	Washer, Flat 5/8" x 2 1/4"	8641-581-032	1
12	Lock Washer Spring, 1/2	8641-582-018	1
13	Screw, 5/8-11 x 1 1/2"	9545-060-001	1

Dryer Tumbler Group 120Lb

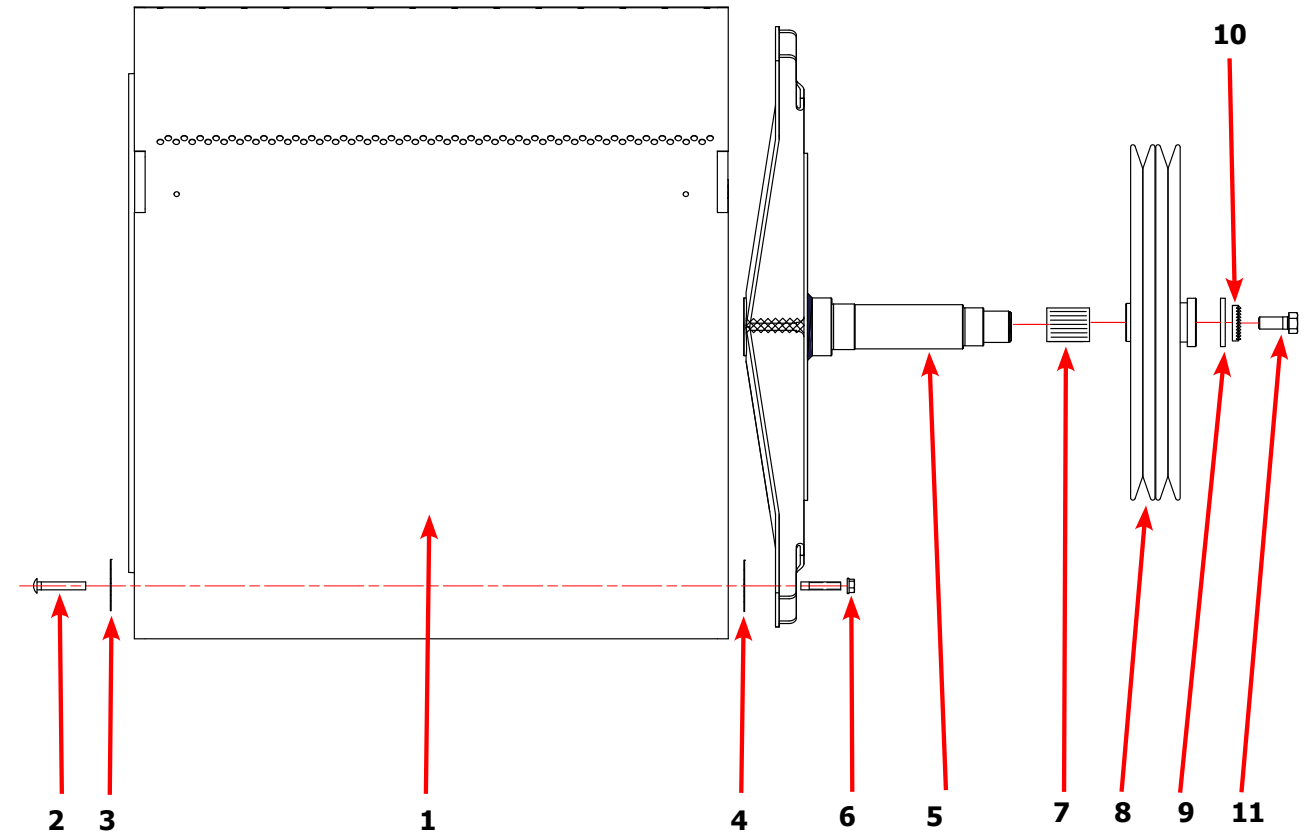

Key	Description	T-120	QTY
*	Tumbler Assy Complete W/Spider (GALV)	9848-153-002	1
1	Tumbler Assy (Galvanized)	9848-152-002	1
2	Rod, Tumbler	9497-226-003	4
3	Plate support, Tie Rod	9452-805-001	4
4	Shim	9552-013-003	AR
5	Spider Assy	9568-016-001	1
6	Nut, Wiz Lock	8640-417-005	4
7	Tolerance Ring	9487-234-006	1
8	Pulley, Driven	9453-168-003	1
9	Washer -Flat	8641-581-032	1
10	LockWasher - IntTooth, 1"	8641-582-018	1
11	Screw, 5/8-11 x 1 1/2	9545-060-001	1

RMC Parts

Key	Description	T-120	QTY
1	Strip-sensing,moisture	9558-034-001	1
*	Rivet-blind,3/16steel	9491-009-001	6
2	Controlsassy-rotatingpcb,rmc	9857-248-001	1
*	Screw-hxwshrundrcuthd,10abx3/8	9545-008-024	2
3	Wiringharness-rmc,sensor,	9627-941-003	1
4	Conduit-rmcwires,	6068-055-001	1
*	Screw-hxwshrundrcuthd,10abx3/8	9545-008-024	2
5	Grommet-3/16id	9209-037-002	1
6	Screw-hxwshrhdsl,10-32tx1/2grn	9545-008-027	1
*	Lockwasher-exttooth,#10	8641-582-006	1
7	Bracketassy-cabinet,RMC	9985-204-001	2
*	Screw-hxwshdsl,10bx1/4	9545-008-001	4
8	Controlsassy-stationarypcb,RMC	9857-247-001	1
*	Nut-hexkeps,#10-32unf,2b	8640-413-002	2
9	Wiringharn-RMC,can/pwr,	9627-940-003	1
10	Cover-service,RMC	9074-385-001	1
*	Screw-hxwshdsl,10bx1/4	9545-008-001	2

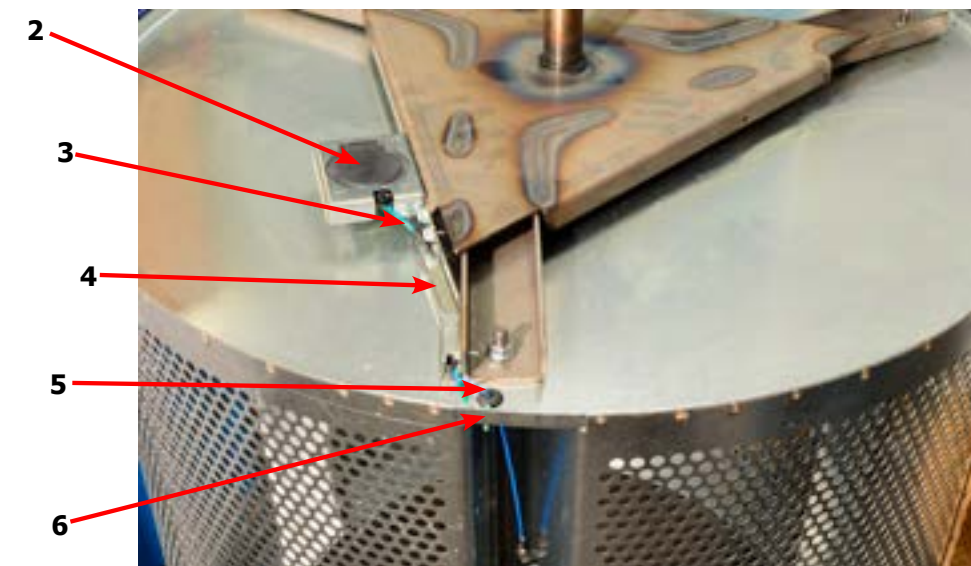
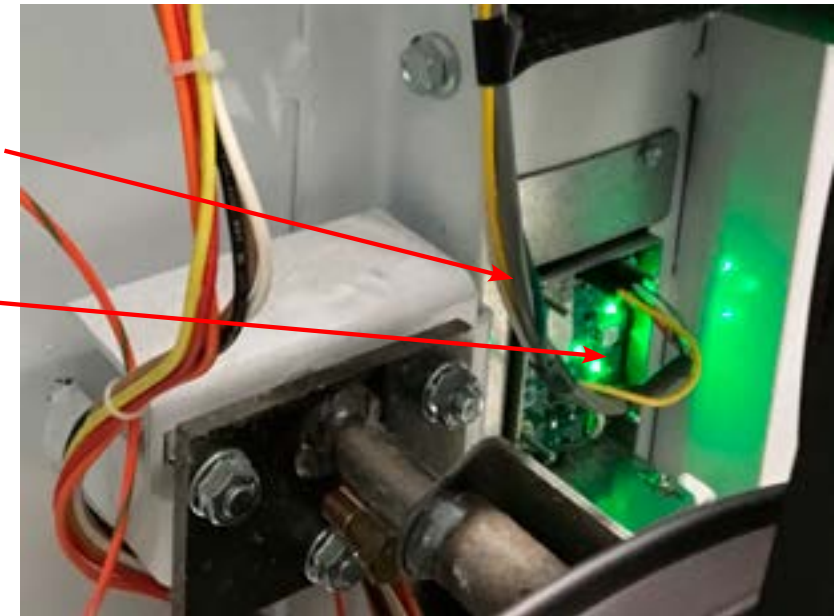
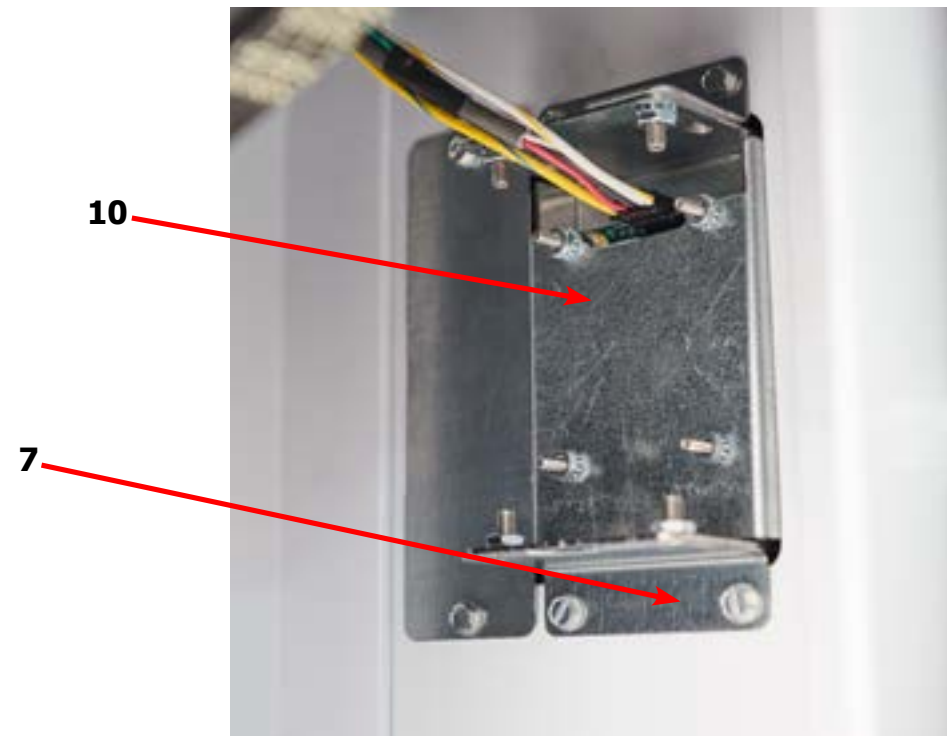

Water Suppression Parts

Key	Description	T-120	QTY
*	FSS Kit	9732-358-004	1
1	Nozzleassy-firesuppression	9872-004-001	1
*	Screw-hxwshrundrcuthd,10abx3/8	9545-008-024	3
2	Tube-nozzle,inlet	9574-262-001	1
3	Bushing-support	9053-083-001	1
*	Screw-hxwshrundrcuthd,10abx3/8	9545-008-024	1
4	Fitting-adapt,3/8nptto1/2hose	8615-115-001	1
5	Valve-water,24v,epdm(nsf)	9379-183-013	1
6	Wireasy-jumper,org/brn,120-6	8220-161-003	1
7	Wireasy-jumper,wht/org,60"-6"	8220-090-019	1
8	Screw-hxwshrhdunct,#10bx1/2	9545-008-026	2
9	Hose-water,3"	9242-453-031	2
10	Fitting-y,1/2	8615-119-001	1
11	Hose-water,"	9242-453-034	1
*	Clamp-hose,worm,1in	8654-117-015	6
*	Clamp-cable	8654-061-001	2
*	Screw-hxwshrundrcuthd,10abx3/8	9545-008-024	2
12	Guard-water valve	9208-145-001	1
*	Screw-hxwshrundrcuthd,10abx3/8	9545-008-024	2
13	Thermostat-fss	9576-212-001	1
*	Screw-hxwshdslt,8bx1/2	9545-045-002	2
	Wireasy-jumper,org,77"	8220-162-002	1
14	Pcbassy-relay	9799-028-001	1
*	Screw-hxwshrundrcuthd, #10Bx1/2	9545-008-026	2
15	Wireasy-jumper,v2.0,relay pcb	8220-159-006	1
16	Wiringharness-cntrl/relay,v2.0	9627-921-001	1
17	Switch-momentary,n.o.	9539-500-001	1
*	Wireasy-org, 75"	8220-108-016	1
18	Wiringharness-relaypowerboard	9628-006-002	1
*	Wireasy-jumper,wht/org,5"	8220-161-002	1
*	Wireasy-org,11"	8220-108-014	1
19	Bracket-mtg,ohp sensor	9029-315-001	
*	Screw-hxwshrundrcuthd,10abx3/8	9545-008-024	

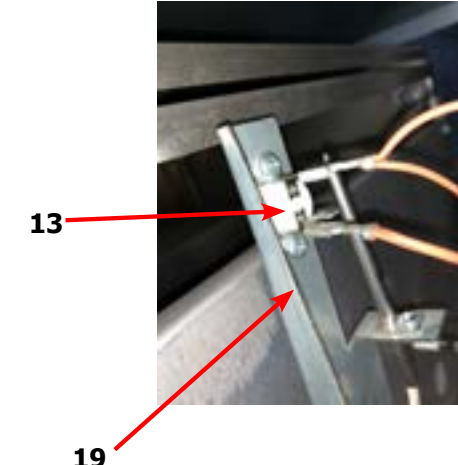
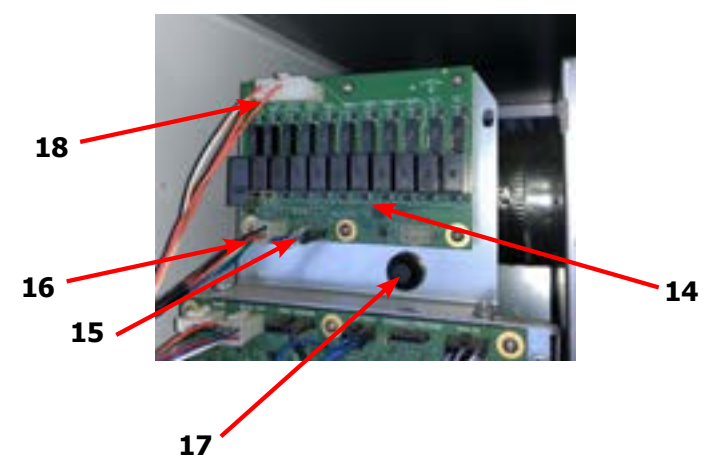
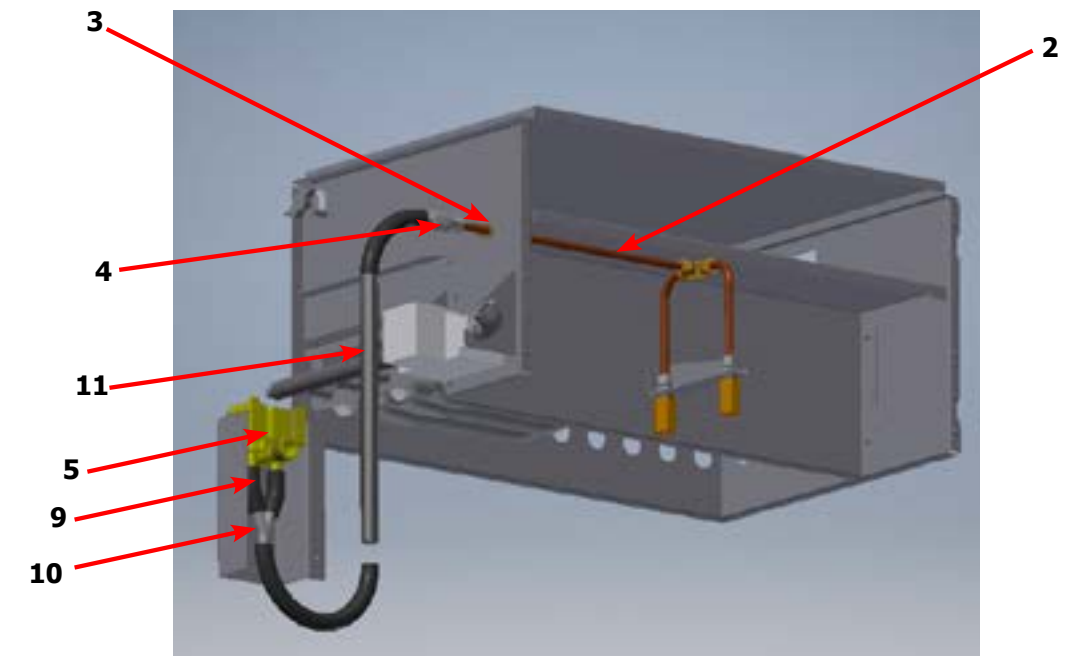
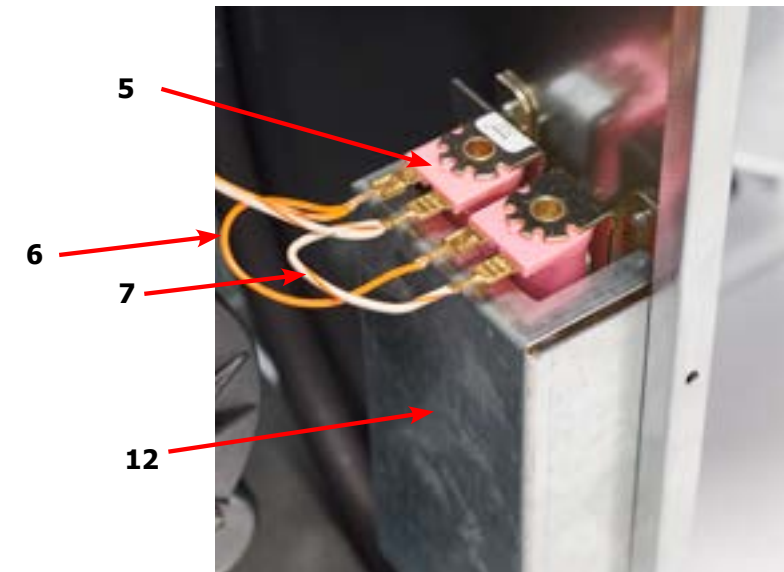

Dryer Burner Housing Group 120Lb

Key	Description	T-120	QTY
*	Housing Assembly, Burner	9803-213-001	1
1	Screw, 10ABx3/8	9545-008-024	55
2	Bracket-Support, Gas Valve	9029-240-001	1
3	Side-Extension Baffle, Burner Housing	9551-049-001	2
4	Burner, Main	9048-022-001	3
5	Baffle-Burner Housing, Extension	9049-105-001	1
6	Panel-Burner Housing, Front	9454-882-001	1
7	Panel-Burner Housing, Back	9454-883-001	1
8	Panel-Burner Housing, Side Left	9551-052-001	1
9	Baffle-Center, Burner	9049-106-001	1
10	Panel-Burner Housing, Side Right	9551-051-001	1
11	Channel-Burner Housing, Right	9081-164-001	1
12	Bracket-Manifold	9029-239-001	1
13	Bracket-Support, Burner, Front	9029-241-001	1
14	Bracket-Support, Burner, Rear	9029-242-001	1
15	Control Assy, Gas Valve, White Rodgers 36H	9857-193-001	1
16	Manifold Assy	9381-013-001	1
17	Top Assembly, Burner Housing	9961-161-001	1
18	Screw, 10Bx1/4	9545-008-001	18
*	Orifice-Natural, #10	9425-069-027	3
*	Orifice-LP, #32	9425-069-009	3
*	Kit, LP Conversion, White Rodgers	9732-102-025	1
19	Thermostat-HI-Limit	9576-203-002	1
20	Electrode-Ignition	9875-002-003	1
21	Bracket-Igniter	9029-243-001	1
22	Elbow-3/4 Street, Black	8615-104-042	1

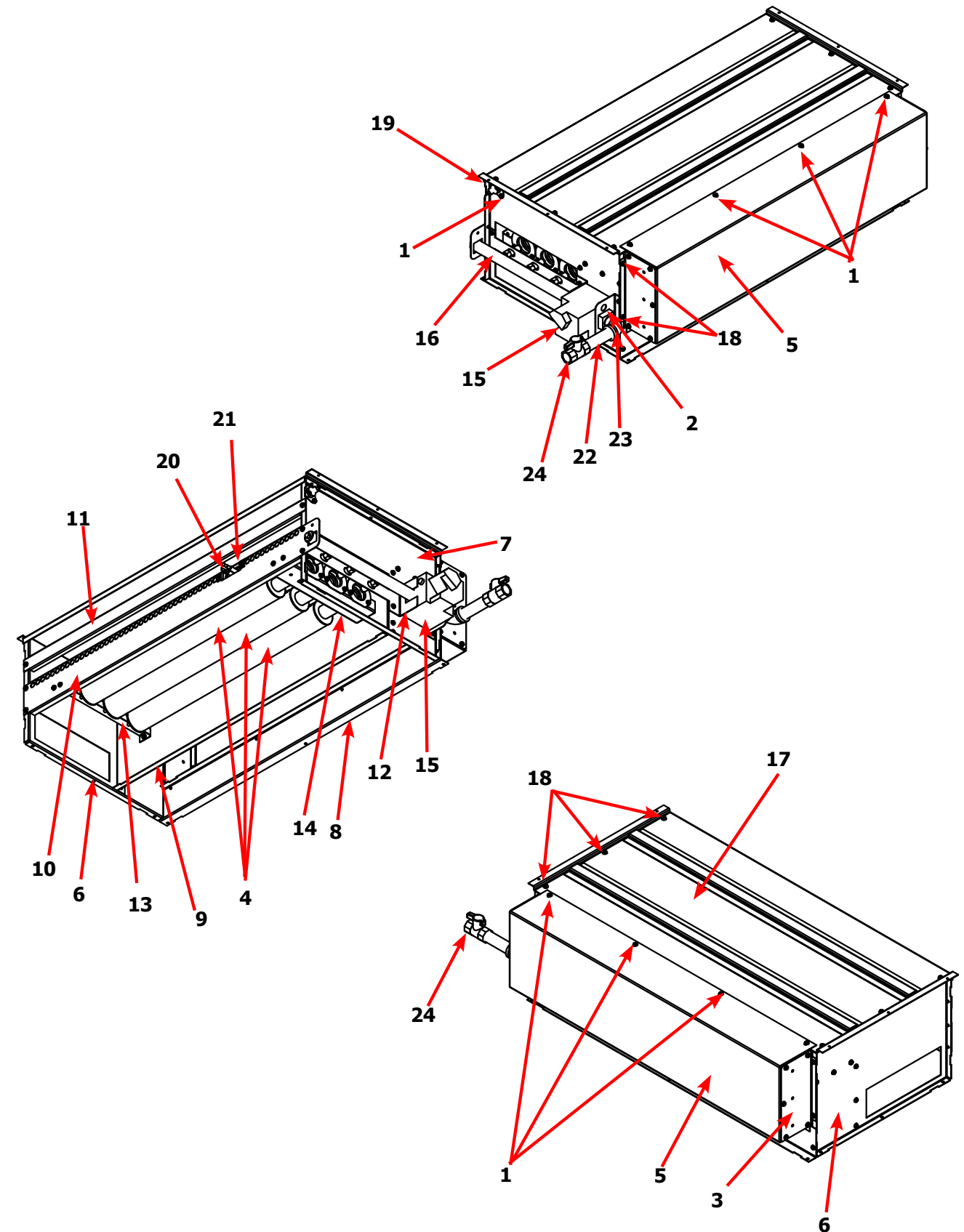

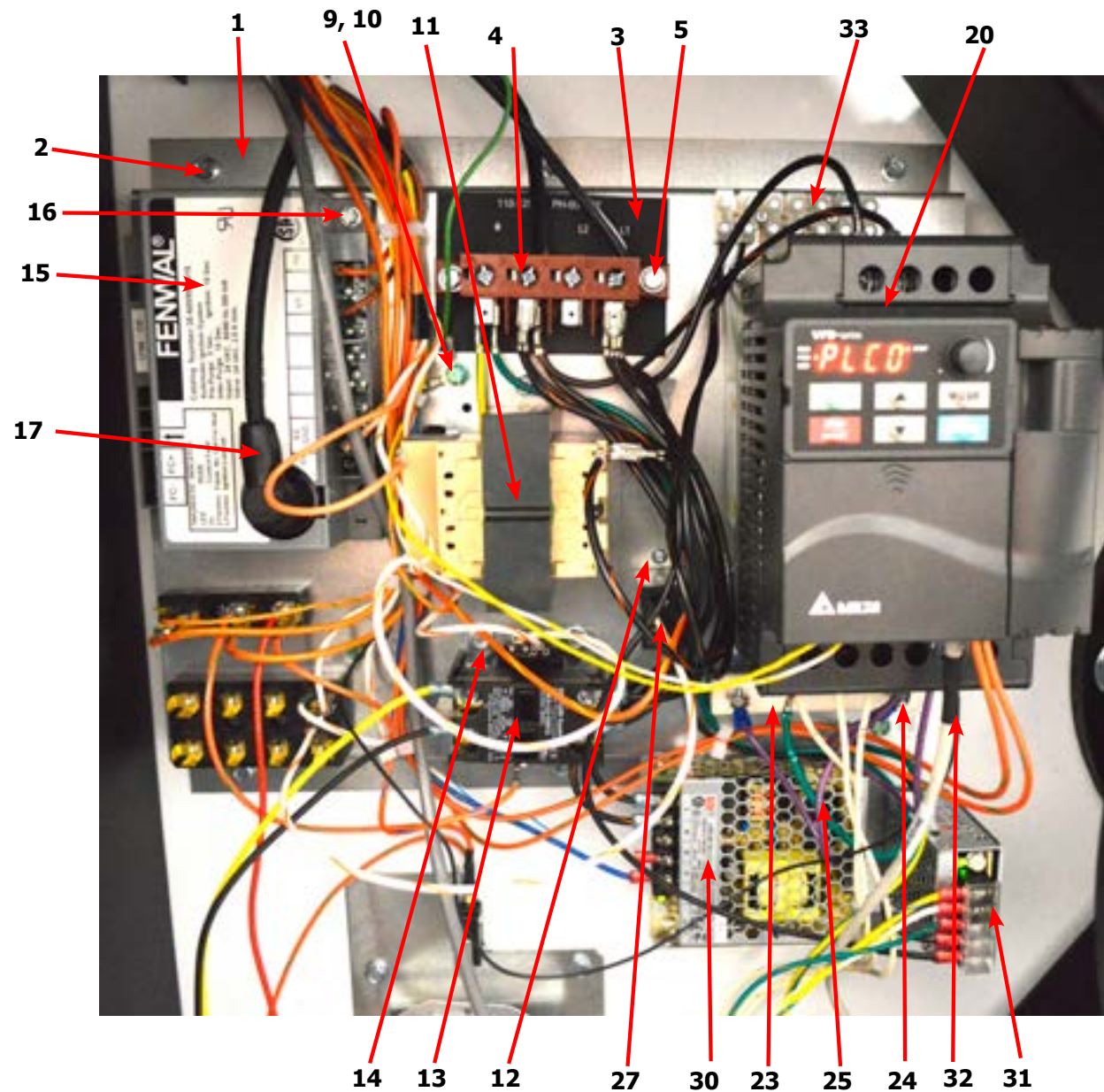

Dryer Rear View-Control Box

Key	Description	T-120	QTY
*	Control Assembly, (1 thru 28) -11	9857-237-001	
*	Control Assembly, (1 thru 28) -10	9857-237-003	
1	Channel-Controls	9081-191-001	1
2	Screw, 5/16-10B-3/8	9545-008-026	6
3	Strip-Marker, Terminal -11	9558-029-006	1
3	Strip-Marker, Terminal -10	9558-029-005	1
4	Terminal Block Assy-Power, 4Pole	9897-035-001	1
5	Screw, 5/16-10AB-3/8	9545-008-024	2
11	Transformer, Control	8711-007-002	1
12	Screw, 5/16-10AB-3/8	9545-008-024	2
13	Relay-Motor, 30Amp, 24VAC	5192-299-002	1
14	Screw, 5/16-10AB-3/8	9545-008-024	2
15	Control Assy, Ignition (Module)	9857-182-001	1
16	Screw-8Bx3/4"	9545-045-007	2
*	Harness, Ignition Module	9627-867-013	1
17	Wire Assy- High Voltage Lead	9631-403-005	1
20	Drive-VD Inverter, 1HP, 208-240VAC -11	9375-032-018	1
20	Drive-VD Inverter, 1HP, 120VAC -10	9375-031-007	1
PS	Key Pad, Delta E-Drive	9150-044-001	1
21	Screw-#10B x 1/2	9545-008-026	4
22	Wire Assy-Green, 18"	8220-092-006	1
23	Resistor-Dynamic Breaking, 200OHM	9483-004-002	1
24	Screw-5/16, 10ABx3/8	9545-008-024	2
25	Wire Assy, Violet 24"	8220-118-003	2
27	Relay, 24VAC	5192-285-004	1
28	Screw, 6B x 3/8	9545-031-003	4
*	Stand off	9527-007-001	7
30	Eleceperiph - Power Supply, 12V	9150-054-001	1
*	Screw - pnhdcr, 6AB x 3/4	9150-054-001	2
31	Eleceperiph - Power Supply, 24VDC	9150-057-001	1
*	Screw - pnhdcrsems, #4-40 x 3/16	9545-020-009	2
32	Data Cable	9806-023-002	1
33	Terminal Block	9897-032-002	1
*	Screw - pnhdcr, 6AB x 3/4	9545-031-010	2

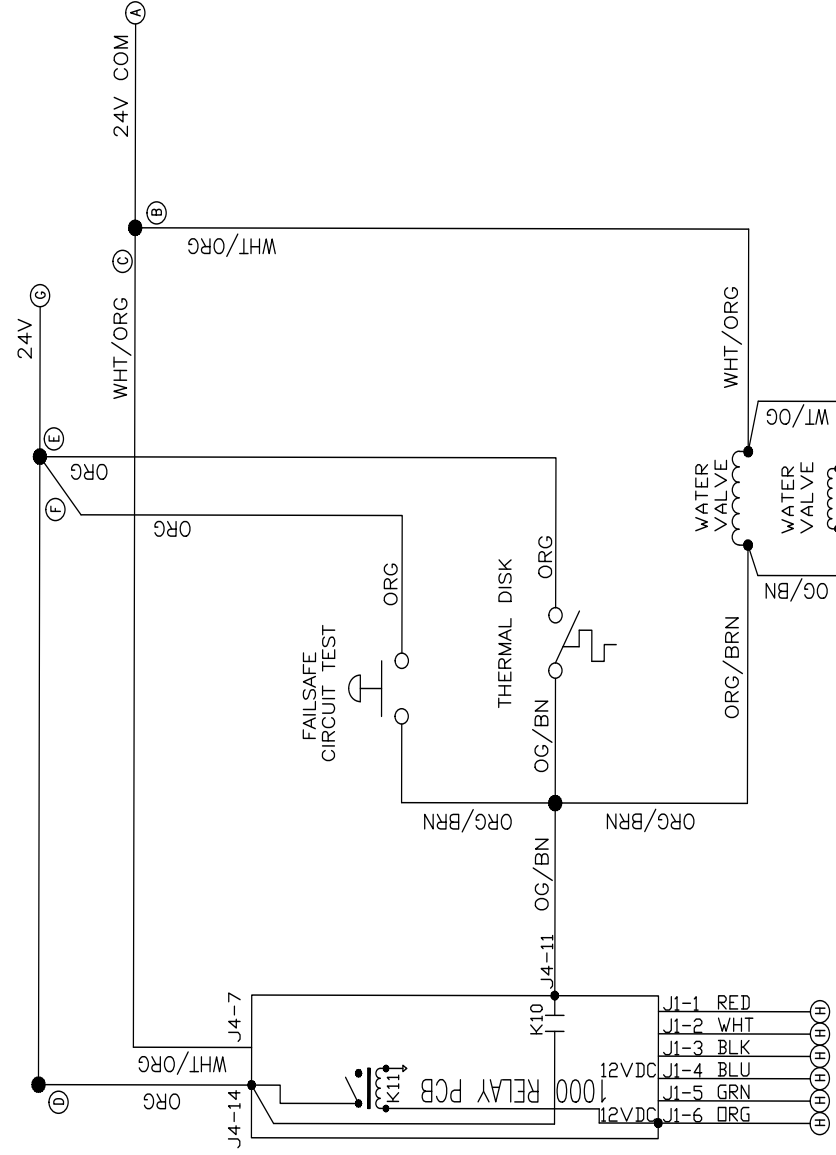

9508-020-001PR

SCHEMATIC

DN0120N_11_0_B- - - - - X

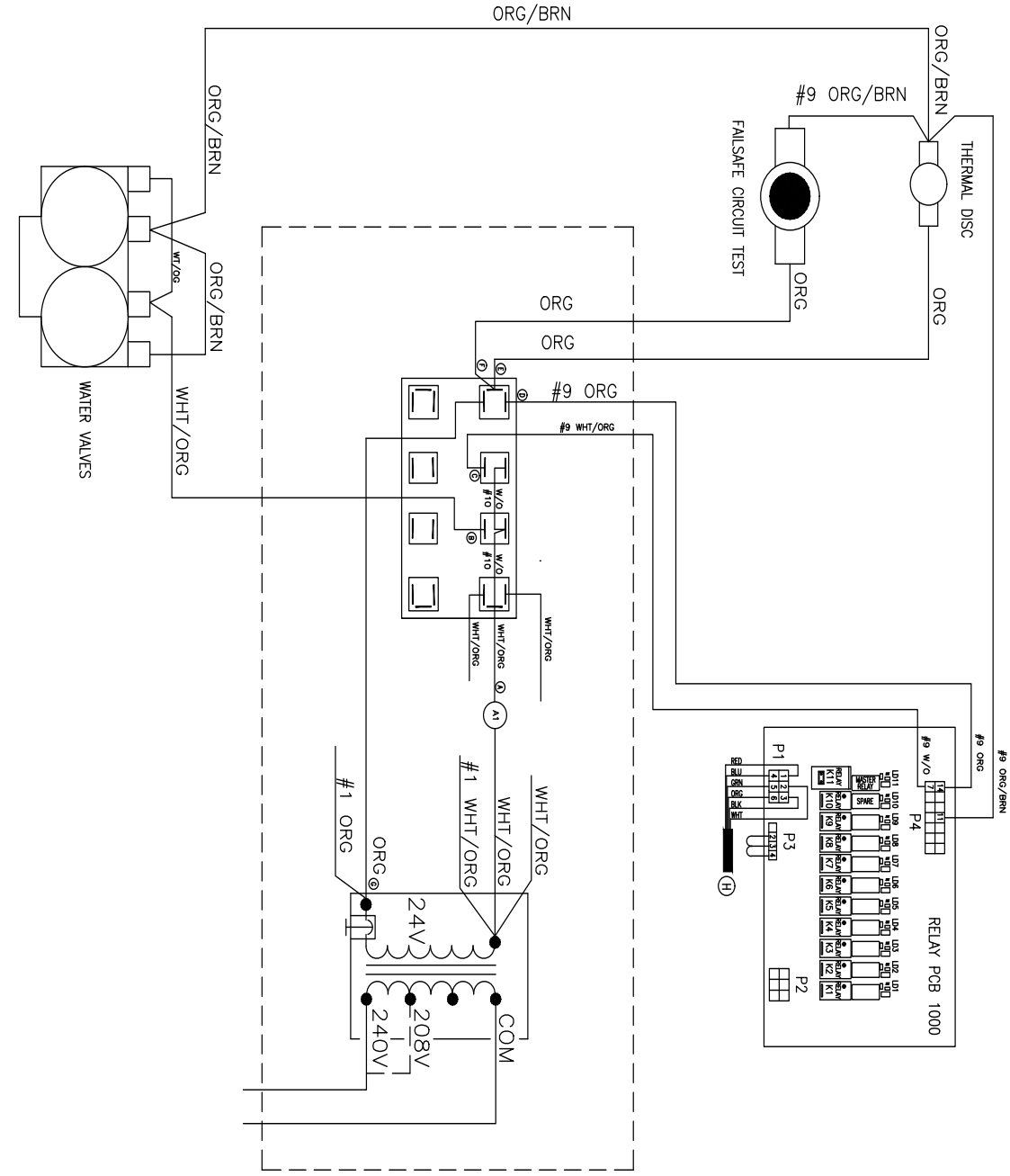

9507-020-001PR

WIRING DIAGRAM

DN0120N_11_0_B- - - - - X

Wiring Schematic -11

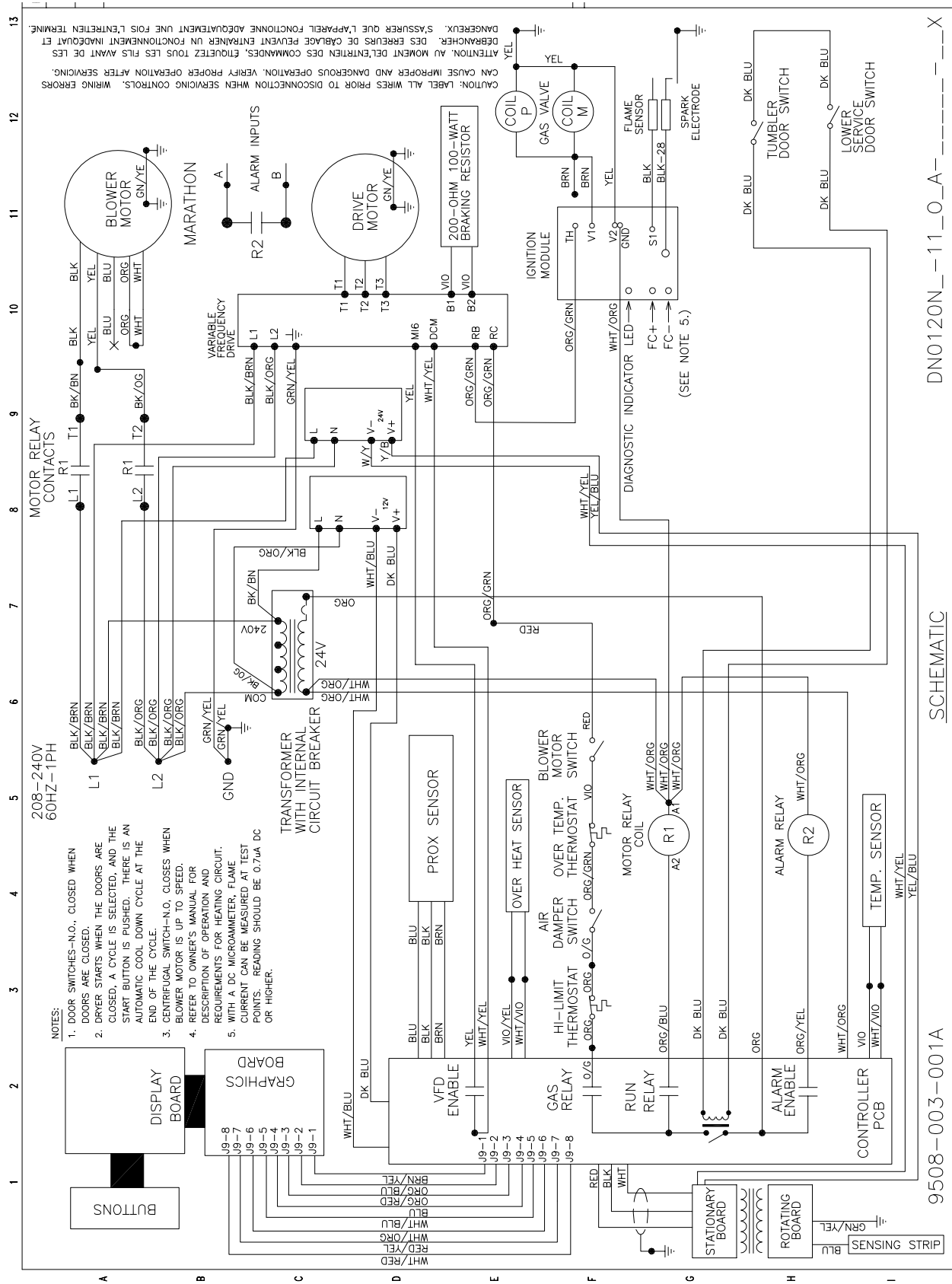

Wiring Diagram -11

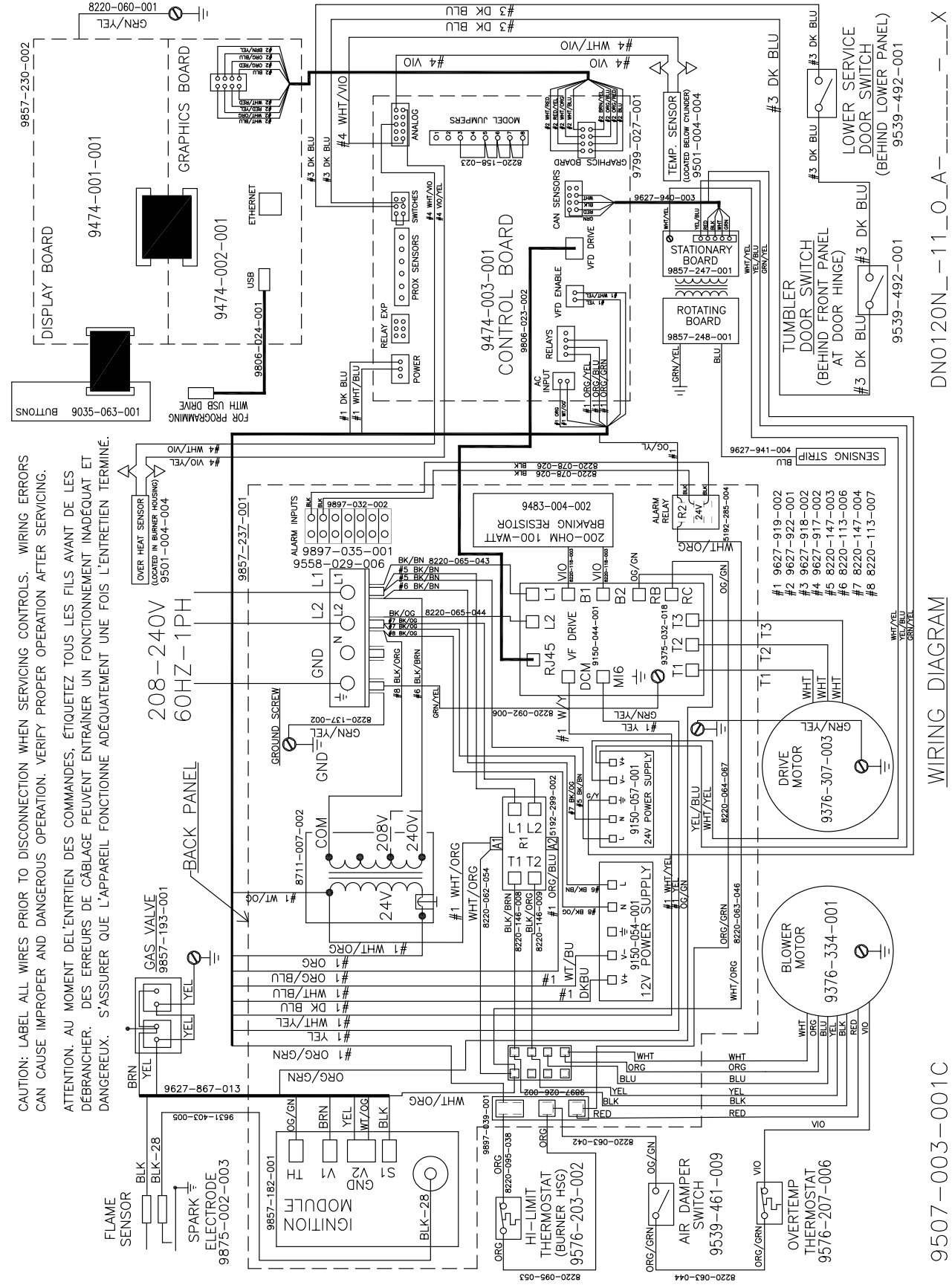

Wiring Schematic -10

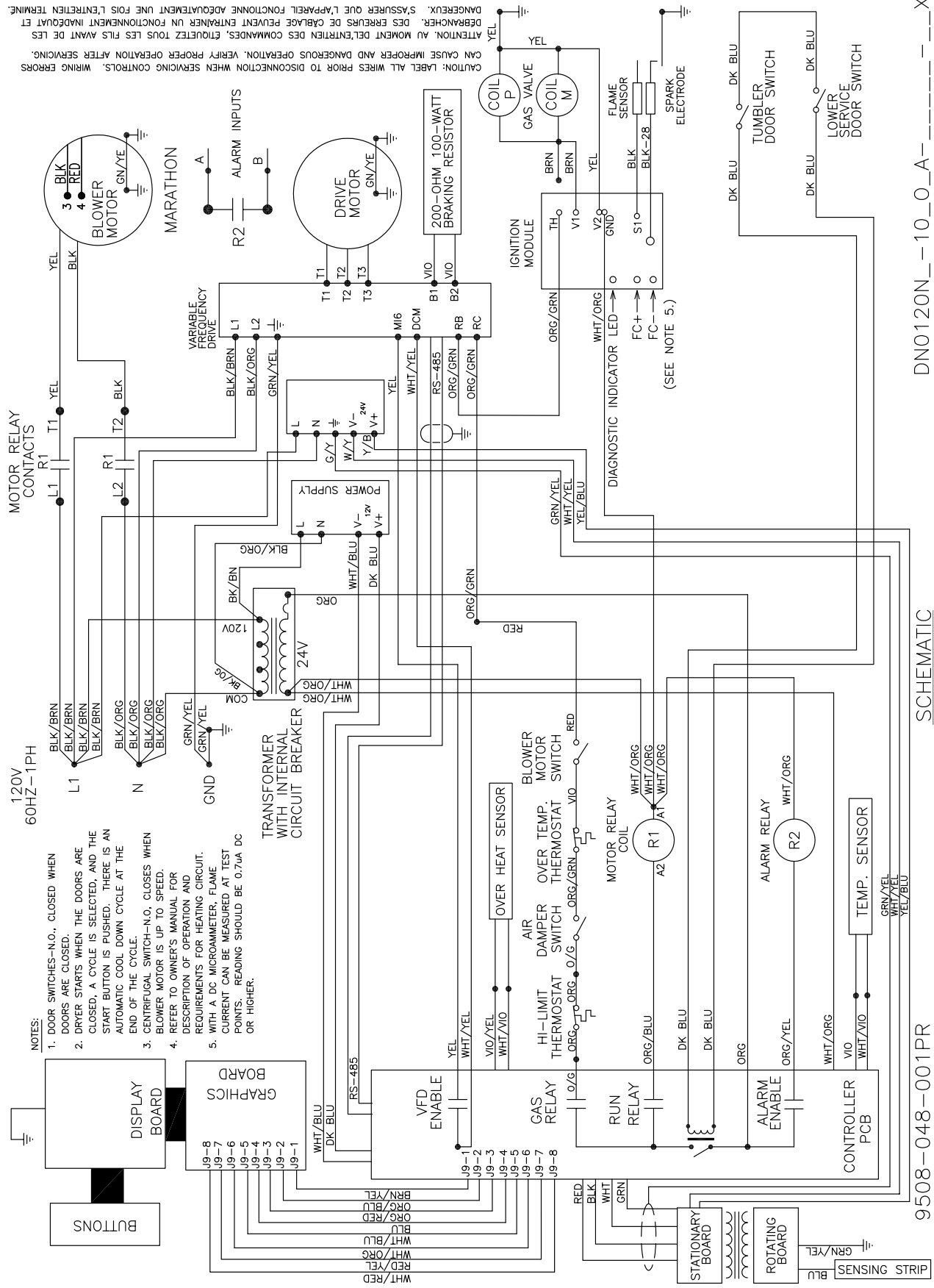

SCHEMATIC

9508-048-001PR

DN0120N_10_0_A

ATTENTION: LABEL ALL WIRES PRIOR TO DISCONNECTION WHEN SERVICING CONTROLS. WIRING ERRORS CAN CAUSE IMPROPER AND DANGEROUS OPERATION. VERIFY PROPER OPERATION AFTER SERVICING. DANGERUEX: S'ASSURER QUE L'APPAREIL FONCTIONNE ADEQUATEMENT UNE FOIS L'ENTRETIEN TERMINE. DERANCHER. DES ERREURS DE CABLAGE PEUVENT ENTRAINER UN FONCTIONNEMENT INADEQUAT ET DANGERUEX.

Wiring Diagram -10

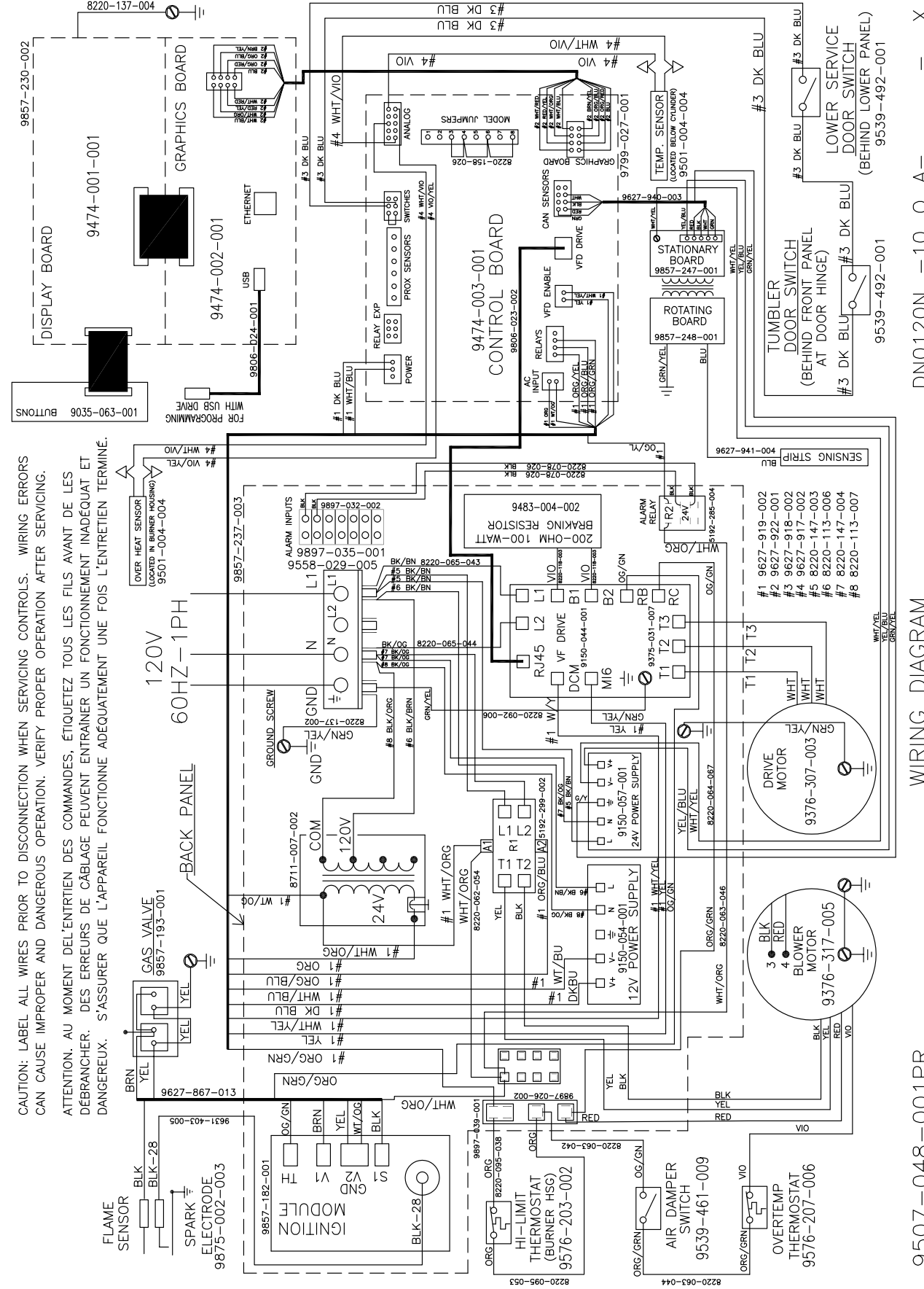

WIRING DIAGRAM

9507-048-001PR

DN0120N_10_0_A

CAUTION: LABEL ALL WIRES PRIOR TO DISCONNECTION WHEN SERVICING CONTROLS. WIRING ERRORS CAN CAUSE IMPROPER AND DANGEROUS OPERATION. VERIFY PROPER OPERATION AFTER SERVICING. ATTENTION: AU MOMENT DEL'ENTRIEN DES COMMANDES, ETIQUETEZ TOUTS LES FILS AVANT DE LES DERANCHER. DES ERREURS DE CABLAGE PEUVENT ENTRAINER UN FONCTIONNEMENT INADEQUAT ET DANGERUEX. S'ASSURER QUE L'APPAREIL FONCTIONNE ADEQUATEMENT UNE FOIS L'ENTRETIEN TERMINE.

Wiring Schematic -39

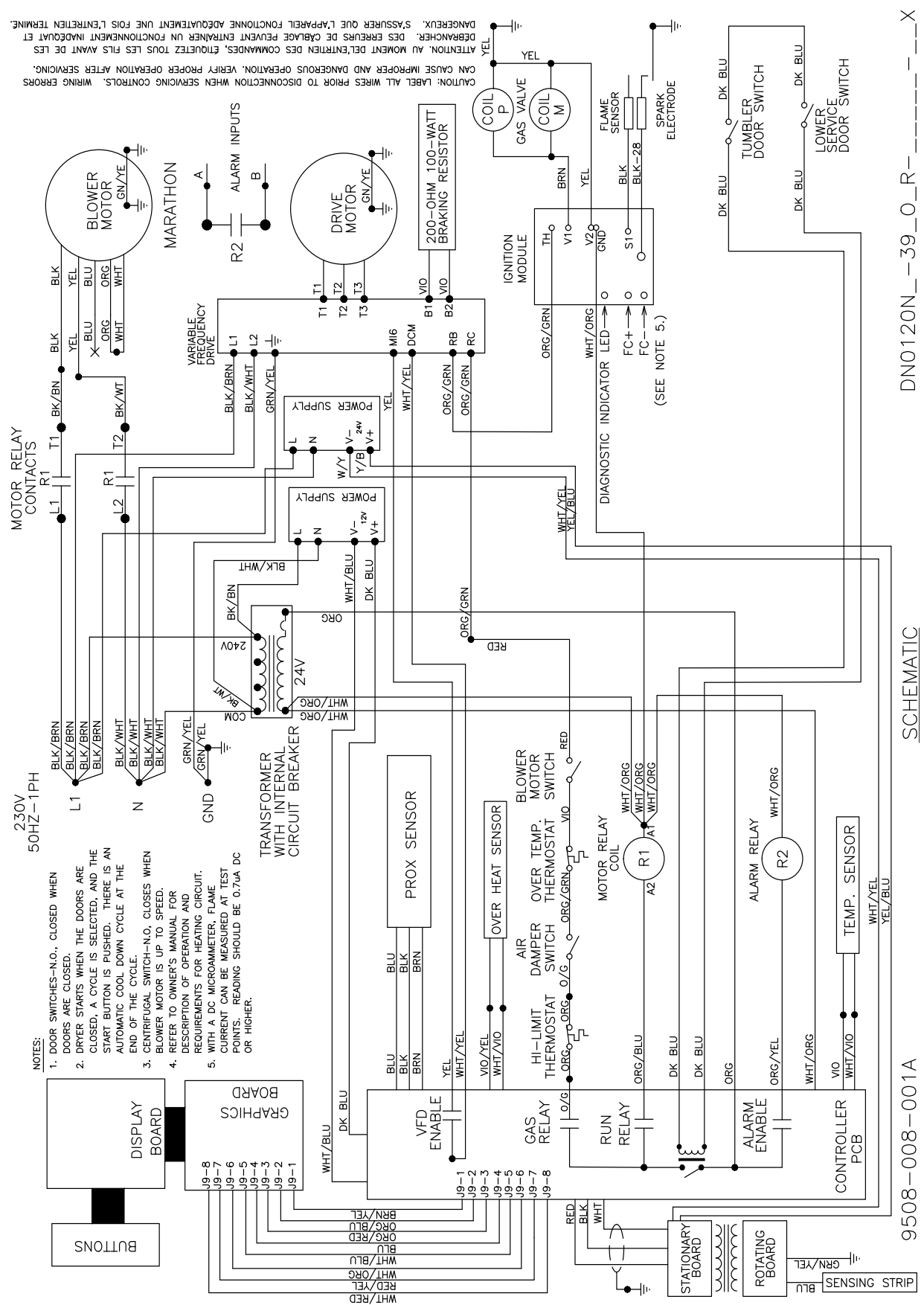

9508-008-001A SCHEMATIC DNO120N_-39_O_R-_-X

Wiring Diagram -39

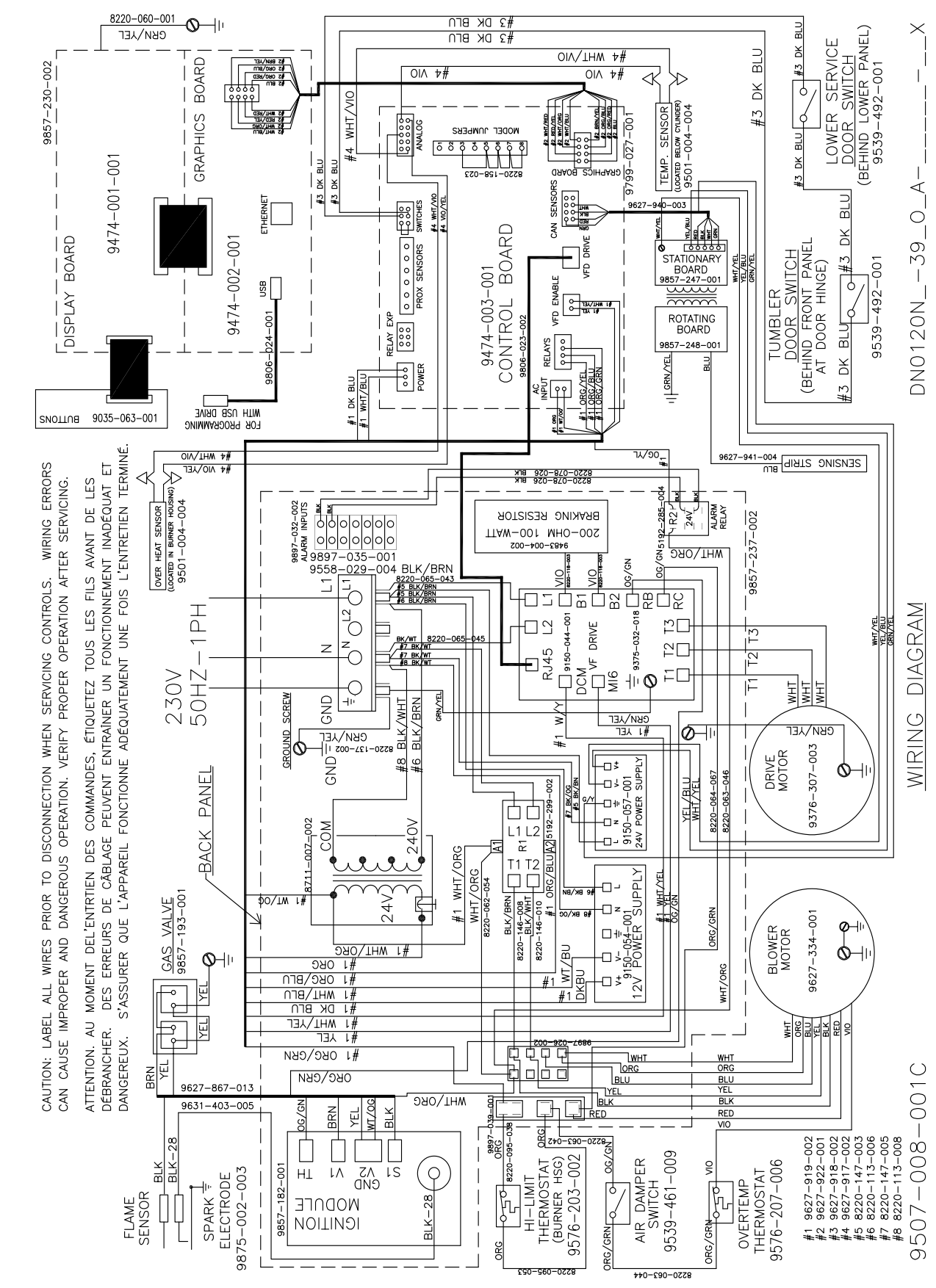

9507-008-001C WIRING DIAGRAM DNO120N_-39_O_A-_-X

Preventative Maintenance

Daily

- Step 1:** Clean the lint screen free of lint and other debris. Use a soft brush and Hot water if necessary.
- Step 2:** Check the lint screen for tears. Replace if necessary.
- Step 3:** Clean lint from the lint screen compartment.
- Step 4:** Inspect felt seal on lint screen assembly, replace if needed.

Monthly

- Step 1:** Remove lint accumulation from the end bells of the motor.
- Step 2:** Remove lint accumulation from front control area.
- Step 3:** Remove lint and dirt accumulation from the top of the dryer and all areas above, below, and around the burners and burner housing. Failure to keep this portion of the dryer clean can lead to a build-up of lint creating a fire hazard.
- Step 4:** Remove and clean coin acceptors. (Vended Models Only)

Quarterly

- Step 1:** Check the belts for looseness, wear, or fraying.
- Step 2:** Inspect the gasket of the door glass for excessive wear.
- Step 3:** Check tightness of all fasteners holding parts to support channel.
- Step 4:** Check tightness of all set screws.
- Step 5:** Remove the air flow switch assembly and check the tumbler thru-bolts for tightness.
- Step 6:** Apply a few drops of oil to pivot pins and the tension arms where in contact with each other.

Semi-Annually

- Step 1:** Remove and clean the main burners.
- Step 2:** Remove all orifices and examine for dirt and hole obstruction.
- Step 3:** Remove all lint accumulation. Remove the front panel and the lint screen housing and remove lint accumulation.

Annually

- Step 1:** Check the intermediate pulley bearings for wear.
- Step 2:** Check and remove any lint accumulation from the exhaust system including recirculation chambers if applicable.
- Step 3:** Grease the bearings and the shaft of the intermediate pulley. Use an Alemite grease gun and Molykote BR2-S grease. (Where applicable)