





***DEXTER***  
***LAUNDRY***









# Dexter Industrial On Premise Stack Washer Dryer

## Parts & Service Manual

# Equipment Safety Warnings

## Symbols and Terminology Used in this Equipment

 <b>DANGER</b>	Indicates an imminently hazardous situation, which if not avoided, will result in death or serious injury.
 <b>WARNING</b>	Indicates a potentially hazardous situation, which if not avoided could result in death or serious injury.
 <b>CAUTION</b>	Indicates a potentially hazardous situation which, if not avoided, may result in minor or moderate injury. It may also be used to alert against unsafe practices. Minor burns, pinch points that result in bruises and minor chemical irritation.
<b>NOTICE</b>	Indicates information or a company policy that relates directly or indirectly to the safety of personnel or protection of property.
	This is the user caution symbol. It indicates a condition where damage to the equipment resulting in injury to the operator could occur if operational procedures are not followed. <b>TO REDUCE THE RISK OF DAMAGE OR INJURY, refer to accompanying documents; follow all steps or procedures as instructed.</b>
	This is the electrical hazard symbol. It indicates that there are <b>DANGEROUS HIGH VOLTAGES PRESENT</b> inside the enclosure of this product. <b>TO REDUCE THE RISK OF FIRE OR ELECTRIC SHOCK, do not attempt to open the enclosure or gain access to areas where you are not instructed to do so. REFER SERVICING TO QUALIFIED SERVICE PERSONEL ONLY</b>
	<b>Caution!</b> There are sharp edges on various sheet metal parts internal to the enclosure. Use safety consciousness when placing or moving your hands while working in the interior of this equipment.
	<b>Caution!</b> To reduce the risk of damage to the Water Inlet Valve, do not supply inlet water with a temperature that exceeds 70° C.  <b>Caution!</b> To reduce the risk of fire or explosion, do not operate this equipment in any hazardous classified (ATEX) environment.

---

# Equipment Safety Warnings

## Symbols and Terminology Used in this Equipment



**Warning! Do not operate equipment if door glass is damaged in any way.**



**Warning! Keep clear of rotating parts.**



**Prohibited! Do not enter this equipment or space.**



**Prohibited! Do not step or stand on this equipment.**









**Prohibited! Do not operate without all guards and covers in place.**



**Prohibited! Do not wash clothing impregnated with flammable liquids (petrochemical).**



**Prohibited! Do not allow children to play in or around equipment.**

	<p>Indicates an imminently hazardous situation, which if not avoided, <u>will result</u> in death or serious injury.</p>
	<p>Indicates a potentially hazardous situation, which if not avoided <u>could result</u> in death or serious injury.</p>
	<p>Indicates a potentially hazardous situation which, if not avoided, <u>may result</u> in minor or moderate injury. It may also be used to alert against unsafe practices. Minor burns, pinch points that result in bruises and minor chemical irritation.</p>
<p>NOTICE</p>	<p>Indicates information or a company policy that relates directly or indirectly to the safety of personnel or protection of property.</p>
	<p>This is the user caution symbol. It indicates a condition where damage to the equipment resulting in injury to the operator could occur if operational procedures are not followed. <b>TO REDUCE THE RISK OF DAMAGE OR INJURY, refer to accompanying documents; follow all steps or procedures as instructed.</b></p>
	<p>This is the electrical hazard symbol. It indicates that there are <b>DANGEROUS HIGH VOLTAGES PRESENT</b> inside the enclosure of this product. <b>TO REDUCE THE RISK OF FIRE OR ELECTRIC SHOCK, do not attempt to open the enclosure or gain access to areas where you are not instructed to do so. REFER SERVICING TO QUALIFIED SERVICE PERSONEL ONLY</b></p>
	<p>Caution! To reduce the risk of fire or explosion, do not operate this equipment in any hazardous classified (ATEX) environment.</p>



## WARNING



●All washers must be installed in accordance to all applicable electrical, plumbing and all other local codes.

●These installation and operation instructions are for use by qualified personnel only. To avoid injury and electrical shock, do not perform any servicing other than that contained in the installation and operation instructions, unless qualified.



Do not install washers in an explosive atmosphere.



●Care must be stressed with all foundation work to ensure a stable unit installation, eliminating possibilities of excessive vibration.

●Foundation must be level within 13 mm to ensure proper washer operation.



Do not operate washer if door glass is damaged in any way.



Do not wash clothing impregnated with flammable liquids (petrochemical).



## WARNING



**Children should be supervised to ensure they do not operate or play in or around equipment.**







**Keep all panels in place to protect against electrical shock and injury and add rigidity to washer.**

**This appliance is not intended for use by persons (including children) with reduced physical, sensory or mental capabilities, or lack of experience and knowledge, unless they have been given supervision or instruction concerning use of the appliance by a person responsible for their safety.**

**A washer should not be allowed to operate if any of the following occur:**

- **Excessive high water level.**
- **Machine is not connected to a properly earthed circuit.**
- **Door does not remain securely locked during the entire cycle.**
- **Vibration or shaking from an inadequate mounting or foundation**

	<p><b>Warning! Do not operate equipment if door glass is damaged in any way.</b></p>
	<p><b>Warning! Keep clear of rotating parts.</b></p>
	<p><b>Prohibited! Do not enter this equipment or space.</b></p>
	<p><b>Prohibited! Do not step or stand on this equipment.</b></p>
	<p><b>Prohibited! Do not operate without all guards and covers in place.</b></p>
	<p><b>Prohibited! Do not operate without all guards and covers in place.</b></p>
	<p><b>Prohibited! Do not wash clothing impregnated with flammable liquids (petrochemical).</b></p>
	<p><b>Prohibited! Do not allow children to play in or around equipment.</b></p>

	<p><b>Prohibited! Do not attempt to open, touch, or proceed before referring to the manual or unless qualified.</b></p>
	<p><b>Mandatory! Read all supporting documentation before operating or maintaining equipment.</b></p>
	<p><b>Mandatory! Disconnect power before servicing equipment.</b></p>
	<p><b>Mandatory! Lock out and tag out before servicing this equipment.</b></p>
	<p><b>Mandatory! Disconnect water supply before servicing equipment.</b></p>
	<p><b>Mandatory! Children should be supervised to ensure they do not operate equipment.</b></p>

# Dexter Safety Guidelines



**These washers are equipped with devices and features relating to their safe operation. To avoid injury or electrical shock, do not perform and service, unless qualified to do so.**

## FOR SAFETY

1. Always shut off power and water supply and also discharge capacitors before servicing.
2. Do not overload the washer.
3. Do not attempt to open door if cylinder is in motion or contains water.
4. Do not mechanically force or override door lock in any way.
5. Do not bypass any safety devices of this washer.
6. Do not use volatile or flammable substances in or near this washer.
7. Keep all panels in place. They protect against shock and injury and add rigidity to the washer.

### **A machine should not be allowed to operated if any of the following occur:**

- Excessively high water level.
- Machine is not connected to a properly grounded circuit.
- Loading door does not remain securely locked during the entire cycle.
- Vibration or shaking from an inadequate mounting or foundation.

To activate your warranty, be sure to return your red warranty form to the factory. Please have serial number and model ready when calling for assistance.

# Table of Contents

## **Section 1:**

Specifications, Mounting Dimensions	
Specifications.....	12-14
Dimensions.....	15 & 16

## **Section 2:**

Installation & Operating Instructions	
Washer Installation .....	18
Electrical Connections & Fusing Requirements .	19
Washer Liquid Chemical Connection.....	20
Dryer Installation.....	21
Dryer Electric, Gas and Venting.....	22 & 23
Washer Operating Instructions.....	24
Dryer Operating Instructions.....	25 & 26

## **Section 3:**

Washer Programming Instructions	
Wash Cycle Programming.....	28-31
Rapid Advance Mode.....	32

## **Section 4:**

Dryer Service, Troubleshooting and Schematics	
Dryer Service Procedures.....	38-39
Dryer Troubleshooting Tips.....	40 & 41
Dryer Schematics 60hz.....	42 & 43

## **Section 5:**

Dryer Parts Data.....	46-69
-----------------------	-------

## **Section 6:**

Electric Heated Dryer & Steam	
Dryer Schematics Electric Heated.....	72-83
Electric Dryer Parts.....	74-89
Steam Parts.....	90-93

## **Section 7:**

50hz Gas Dryers	
50hz Dryer Parts.....	96
50hz Dryer Schematics.....	97-99

## **Section 8:**

50hz Electric Dryers	
50hz Electric Dryer Parts.....	102-111

---

**Section 9:**

## Washer Service and Troubleshooting

Mechanical Coin Drop Acceptor.....	114
Front Panel Removal.....	114
Back Panel Removal.....	114
Drain Valve Access.....	114
Drain Valve Cleaning.....	114
Masking Ring Removal.....	114
Detergent Dispenser.....	114
Vacuum Breaker/Air Gap.....	114
Water Valves.....	115
Door Locking Solinoid.....	115
Thermoactuators.....	115
Lock Thermoacustors.....	115
Unlock Thermoacuators.....	115
Drive Belt Removal.....	115
Door Lock Assembly Operation.....	116
Adjustment for Door Lock Assembly.....	116-117
Adjusting the Loading Door.....	118
Loading Door Removal.....	118
Loading Door Hinge Removal.....	118
Loading Door Disassembly.....	118
Loading Door Reassembly.....	119
Control Panel Name Plate Decal.....	119
Name Plate Removal.....	119
Re-Installation of Name Plate.....	119
Removal of the Washer Tub Assembly From the Washer Frame.....	119
Tub Back, Bearing and Cylinder Assembly.....	120
Basket Pulley, Bearing Housing, Water Seals & Tub Back.....	120
Bolt Torque Chart.....	122
Control Mounting Trough.....	123
Main Data Communication Cable.....	123
Circuit Breaker/Fuse.....	123
Main Control Printed Circuit Board.....	123
PCB Transformer Step Down.....	123
Controls Transformer.....	123
Main Relay Printed Circuit Board.....	123
LED Printed Circuit Board Temperature & Start Display Push Button.....	123
Add Bleach LED.....	124

Pressure Switch.....	124
Power Connection Terminal Block.....	124
Delta Variable Frequency Drive.....	124
Delta VFD Motor Leads.....	124
Delta VFD Dynamic Braking Resistors.....	124
Delta VFD Cooling Fan.....	125
Washer Trouble Shooting and F - Codes...	126-133

**Section 10:**

## Washer Electrical &amp; Wiring Schematics

Start Circuit.....	136
Fill Circuit.....	136
Wash Circuit.....	137
Drain, Rinse 1 & 2 & Final Rinse Circuit.....	137
Extract Circuit.....	137
Thermoactuator and Shake Out Circuit.....	137
End of Cycle Circuit.....	137
Motor Winding Resistances.....	137
Washer Electrical & Wiring Schematics 60hz .....	138 & 139

**Section 11:**

## Washer Parts Data

V-Series Accessories.....	142
Electrical Components.....	144-145
Front Control Group.....	146
Labels & Diagrams.....	147
Cabinet and Front Panel Group.....	148-151
Door Lock Parts.....	152
Loading Door Parts.....	153
Loading Door Hinge Parts.....	154-157
Drain Valve Group Parts.....	158
Water Inlet Parts.....	159
Rear View Access Parts.....	160 & 161
Chasis and Drain Parts.....	162 & 163
Cylinder, Seals & Bearings Parts.....	164 & 165

**Section 12:**

50hz Washer.....	168
Schematics & diagrams.....	169 & 170

**Section 13:**

Maintenance Dryer.....	172-173
Maintenance Washer.....	151

---

# **Section 1:**

Washer and Dryer

Specifications and  
Mounting

# Stacked Washer Dryer Models

Stacked Model Designation	Washer \ Dryer Model #	Electrical Spec: Circuit Breaker / Running Amps / Wire Size/ Option
<b>SCVD60HMB-14</b>	<b>DSTD30HTB-10</b>	120/60/1 - 2 wire + ground 15amp / 9.8 amp / #12
	<b>WSVD30HCB-12</b>	208-240/60/1or3, Single 2 Wire + Ground, 3 Phase 3 Wire plus Ground
<b>SCVD60HMB-14FS</b>	<b>DSTD30HTB-10FS</b>	120/60/1 - 2 wire + ground 15amp / 9.8 amp / #12 / FS=Steam Coil Heated
	<b>WSVD30HCB-12</b>	208-240/60/1or3, Single 2 Wire + Ground, 3 Phase 3 Wire plus Ground
<b>SCVD60HMB-14ST</b>	<b>DSTD30HTB-10</b>	120/60/1 - 2 wire + ground 15amp / 9.8 amp / #12
	<b>WSVD30HCB-12ST</b>	208-240/60/1or3, Single 2 Wire + Ground, 3 Phase 3 Wire plus Ground ST=100G Extract Drive
<b>SCVD60HMB-14TS</b>	<b>DSTD30HTB-10TS</b>	120/60/1 - 2 wire + ground 15amp / 9.8 amp / #12 TS= Stainless Tumbler
	<b>WSVD30HCB-12</b>	208-240/60/1or3, Single 2 Wire + Ground, 3 Phase 3 Wire plus Ground
<b>SCVD60HMB-16FC</b>	<b>DSTD30HTB-16FC</b>	208/60/3 - 3 wire + ground / 24kW 90 amp / 85amp / #2
	<b>WSVD30HCB-12</b>	208-240/60/1or3, Single 2 Wire + Ground, 3 Phase 3 Wire plus Ground
<b>SCVD60HMB-16FCST</b>	<b>DSTD30HTB-16FC</b>	208/60/3 - 3 wire + ground / 24kW 90 amp / 85amp / #2
	<b>WSVD30HCB-12ST</b>	208-240/60/1or3, Single 2 Wire + Ground, 3 Phase 3 Wire plus Ground ST=100G Extract Drive
<b>SCVD60HMB-18FD</b>	<b>DSTD30HTB-18FD</b>	240/60/3 - 3 wire + ground / 24kW 80 amp / 75amp / #3
	<b>WSVD30HCB-12ST</b>	208-240/60/1or3, Single 2 Wire + Ground, 3 Phase 3 Wire plus Ground ST=100G Extract Drive
<b>SCVD60HMB-21</b>	<b>DSTD30HTB-21</b>	230/50/1 - 2 wire + ground 15amp / 5.0amp / #12
	<b>WSVD30HCB-21</b>	230/50/1 - 2 wire + ground 15amp / 5.0amp / #12
<b>SCVD60HCB-21FS</b>	<b>DSTD30KCB-21CNFS</b>	KCB=Coin Control 230/50/1 - 2 wire + ground 15amp / 5.0amp / #12 / CN=No Coin Mech / FS=Steam Coil Heated
	<b>WSVD30HCB-21</b>	230/50/1 - 2 wire + ground 15amp / 5.0amp / #12
<b>SCVD60HMB-27FL</b>	<b>DSTD30HTB-27FL</b>	220/50/1 - 2 wire + ground / 20kW 110 amp / 105 amp / #1
	<b>WSVD30HCB-21</b>	230/50/1 - 2 wire + ground 15amp / 5.0amp / #12
<b>SCVD60HMB-29FN</b>	<b>DSTD30HTB-29FN</b>	380/50/3 - 4 wire + ground / 22kW 50 amp / 45 amp / # 6
	<b>WSVD30HCB-21</b>	230/50/1 - 2 wire + ground 15amp / 5.0amp / #12
<b>SCVD60HMB-60FA</b>	<b>DSTD30HTB-60FA</b>	208/60/1 - 2 wire + ground / 20kW 125 amp /120 amp / #1
	<b>WSVD30HCB-12</b>	208-240/60/1or3, Single 2 Wire + Ground, 3 Phase 3 Wire plus Ground
<b>SCVD60HMB-61FB</b>	<b>DSTD30HTB-61FB</b>	240/60/1 - 2 wire + ground / 20kW 110 amp /105 amp / #1
	<b>WSVD30HCB-12</b>	208-240/60/1or3, Single 2 Wire + Ground, 3 Phase 3 Wire plus Ground

---

## Washer Specifications:

Dry Weight Capacity	30 lbs	(13.6 kg)
Cylinder Diameter	25"	(63.5 cm)
Cylinder Depth	14.13"	(35.9 cm)
Cylinder Volume	4 cu ft	(113.4 l)
Floor to Door Bottom	16"	(40.61 cm)
Door Opening	15.25"	(38.71 cm)

### Speeds G-Force (RPM)

High Extract Speed	200 G	750 RPM
Intermed. Extract Speed	60 G	411 RPM
Washing Speed	.96	50 RPM
Motor Size	2 HP	1.5 kw

### Electrical

Electrical Phase	Single or Three
Electrical Voltage (60 Hz)	208-240
Electrical Running (Amps)	6.2
Circuit Protection (Amps)	15 amp
Electrical Wire Size	12 gauge
Electrical Service (Single)	2 wire + ground
Electrical Service (Three)	3 wire + ground

### Water

Water Inlet Size	3/4"	(19mm)
Flow Rate (per min)	9 gal	(34.1 L)
Pressure (min/max)	30-120 psi	(207-827 Kpa)
Drain Diameter (O.D.)	3"	(7.61 cm)
Floor to Center of Drain	4.5"	(11.23 cm)

### Installation Recommendations

Clearance Between Machines	1/2 (min)	(1.31 cm)
Clearance Behind Machines	24" (min)	(61.0 cm)
Concrete Thickness	6" (min)	(15.24 cm)
Net Weight	1039 lbs	(471.3 kg)
Shipping Weight	1090 lbs	(494.4 kg)

### Approvals\*\* UL/CSA

### Cabinet Dimensions

Height - in (cm)	78.75"	(200.0cm)
Width - in (cm)	31.5"	(80.0cm)
Depth - in (cm)	48"	(115.2 cm)

---

## Dryer Specifications:

Dry Weight Capacity	30 lbs	(13.6 kg)
Cylinder Diameter	30"	(76.21cm)
Cylinder Depth	27.5"	(69.95 cm)
Cylinder Volume	11.25 cu ft	(318 l)
Floor to Door Bottom	48"	(115.2 cm)
Door Opening	22.6875"	(57.63 cm)

### Energy Data

Gas Models	60Hz - 80,000 BTU/hr	(26.4kW)/pocket)
	50Hz- 80,000 BTU/hr	(26.4kW)/pocket)

### Electric Models See Below

Electrical Spec: Circuit Breaker / Running Amps / Wire Size

### Gas

- 21 (230/50/1 - 2 wire + ground) 15amp / 5.0amp / #12
- 10 (120/60/1 - 2 wire + ground) 15amp / 9.8 amp / #12

### Electric

- 16FC (208/60/3 - 4 wire + ground) - 24kW 90 amp / 85amp / #2
- 18FD (240/60/3 - 4 wire + ground) - 24kW 80 amp / 75amp / #3
- 60FA (208/60/1 - 3 wire + ground)) - 20kW 125 amp /120 amp /#1/0
- 61FB (240/60/1 - 3 wire + ground) - 20kW 110 amp /105 amp /#1/0

Tumble Speed	47 RPM	
Air flow - cfm (M3/min)	60HZ-500	14.16 m3/min
Gas Supply Connection	0.5"	(12.7mm)
Natural Gas (water column)	5-8"	(12.7 - 20.3cm)
L.P. Gas Supply (water column)	11.5 - 14"	(29.2 - 35.5cm)
Operating (water column)	3.5" inches	
Make-Up Air	1.0 sq ft	(1394 sq cm)
Exhaust Size - in (cm)	6"	(20.3cm)
	Maximum Length with (2 elbows) 14ft.	

### Shipping Dimensions

Height - in (cm)	83.25"	(211.5cm)
Width - in (cm)	33.0"	(83.2cm)
Depth - in (cm)	54.0"	(137.2cm)

# Machine Dimensions:

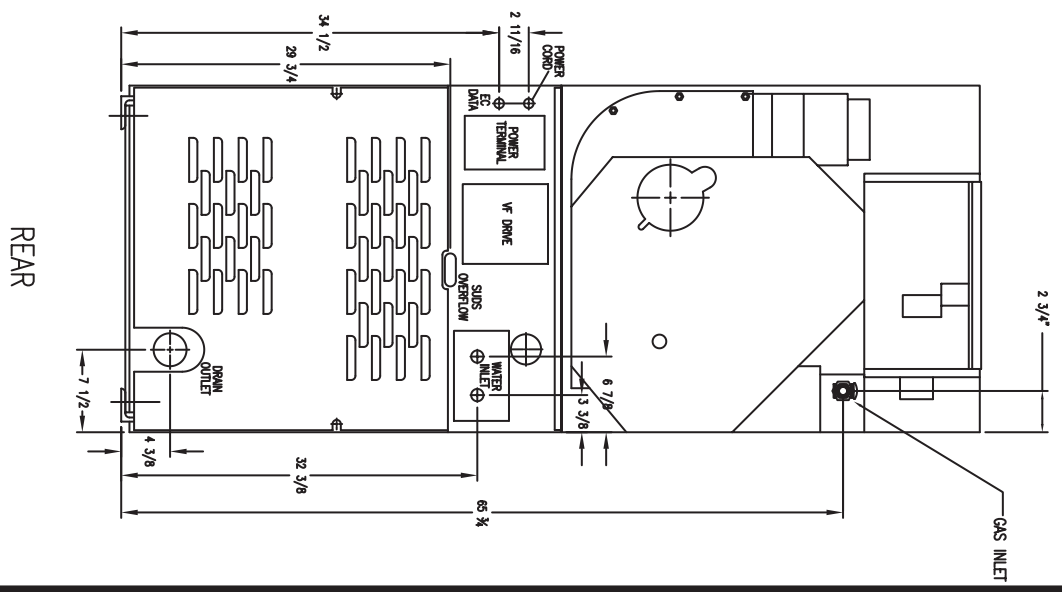
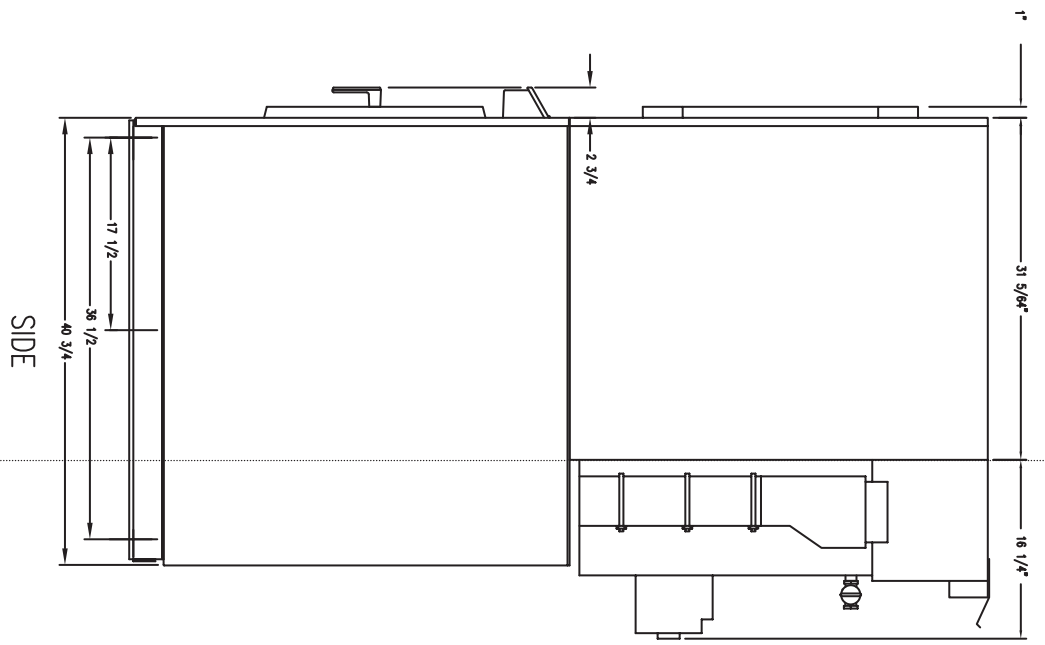
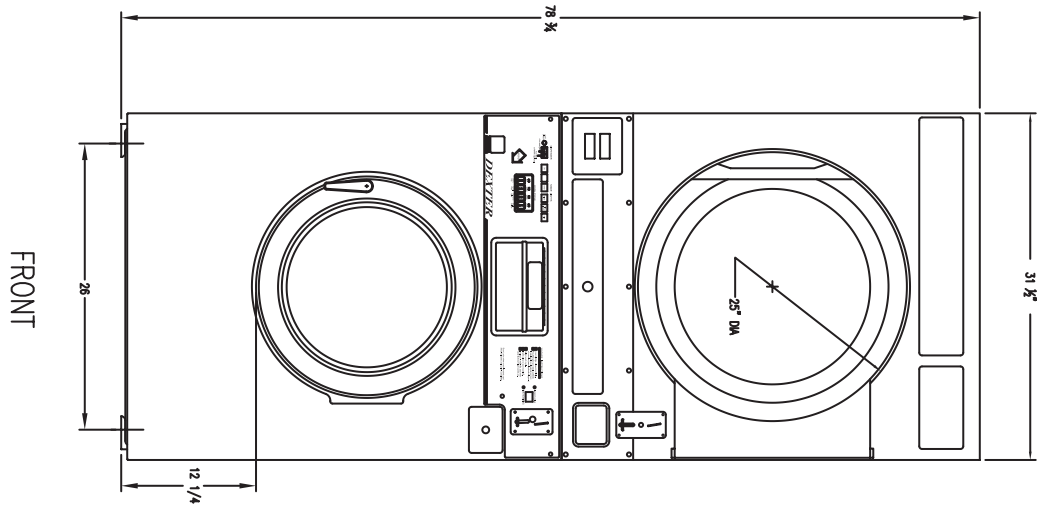

STACK WASHER/DRYER  
MOUNTING DIMENSIONS



---

## **Section 2:**

Washer and Dryer  
Installation  
& Operating  
Instructions

---

# Washer Installation

**All washers must be installed in accordance with all local, state and national building, electrical, and plumbing codes in effect in the area.**

## Foundation Requirements

The washer must be securely bolted to a substantial concrete floor, or mounted upon a suitable base which is securely bolted and machine grouted to a substantial concrete floor. Care must be stressed with all foundation work to insure a stable unit, eliminating vibration. All installations must be made on sound concrete floors 6" or thicker. Anchor bolts must be of a quality grade and at least imbedded at minimum of 5" in length and minimum 5/8" diameter.

## Mounting

A concrete pad or steel base which elevates the machine 4 to 6 inches above the floor level. To provide easy access to the loading door, it is recommended to allow a minimum of 18" of clearance behind the rear of the machine for service as is shown. SIX (6) bolts are required to mount the washer to the steel base or concrete pad. Grouting where base or machine makes contact with concrete is REQUIRED to achieve 100% surface contact and for warranty to be honored.

**Note: Premanufactured bases are available from DEXTER factory (see sales dept.)**

## Mounting Bolts

The following pages illustrate the mounting dimensions for the machine and also show a typical concrete pad arrangement.

**Note: Mounting bolts should be checked frequently to insure that they remain tight. The machine should be checked with a spinning load to be sure there is no unusual vibration or movement between the machine and the base or floor.**

## Proper Machine Grout Required Installation

Machine grout must be installed between base (if used) and concrete floor on all side rails and crossmembers. If using a base you must grout between base top and machine frame and all side rails and crossmembers.

## Plumbing

Water supply hoses are furnished with each machine. The threaded connections on the hoses are standard garden hose type thread. Separate hot and cold water lines with shut off valves or faucets for inlet hose connections must be provided, maintaining 30 to 120 p.s.i. water flow pressure. Maximum water temperature is 180 degrees.

## Drain

The drain outlet tube at the rear of the machine is 3" in outside diameter on models. Adequate fall for this gravity drain must be maintained for proper drainage.

## Protective Film

The machine may have protective adhesive film on the front escutcheon area and the front and side stainless steel panels. The film may be peeled off before putting the machine into service.

## Electrical

Dexter single/three-phase 208-240VAC 60 Hz washing machines are intended to be permanently installed appliances. No power cord is provided. The machine should be connected to an individual branch circuit not shared by lighting or other equipment. The connection should be sheathed in liquid tight flexible conduit, or equivalent, with conductors of the proper size and insulation. A qualified technician should make such connections in accordance with the wiring diagram.

Each unit should be connected to an individual branch circuit not shared by lighting or other equipment. Conductors of the proper size and insulation (suggested size below) should be used.

## To Make Electrical Connections

Disconnect all power to the washer. Remove screw and lift out the cover located in the upper left corner of the machine (as viewed from the back).

- If power is 208-240-3PH-60Hz, connect L1, L2, L3 and ground. If there is a high leg it must be connected to L3. It is highly recommended to use a TVSS. (see Informative inside Washer)
- If power is 208-240-1PH-60Hz, connect L1, L2 and Ground.

NOTE: It is important that the grounding screw next to the power terminal block TB-1 be connected to a good external ground.

## Controls Transformer

The controls transformer is located inside the control trough and steps a range of 208 to 240 volts down to 115 volts. There are two terminals on the controls transformer for the primary (incoming) power. Use the terminal marked "208V" for power supplies between 200 and 215 volts. Use the terminal marked "230V" for power supplies between 216 and 240 volts.

NOTE: transformer must be set at proper tap for proper operation.

## Electrical Connections

Electrical power connections are made to the small terminal block located in the rear of the control trough. The terminal block is accessed by opening the top panel of the machine.

- 1 Phase or 3 Phase connections
- 208-240 volts, 60 Hz.
- 3 wire plus ground
- Suggested Minimum Wire Size -- 12 Ga.

## Fusing Requirements:

Dual element time delay fuse or equivalent breaker of amperage specified below.

- 1 Phase or 3 Phase 15 amp
- WSVD-30

Rotation in extract as viewed through glass door at front of washer models WSVD-30 will be counter-clockwise.

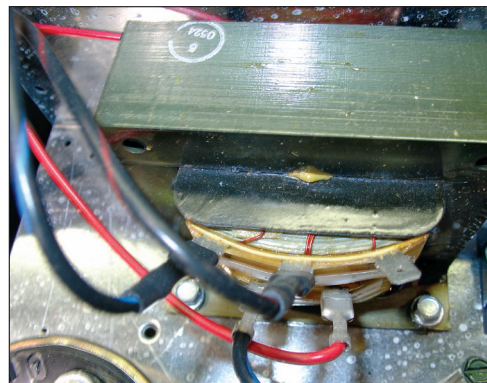
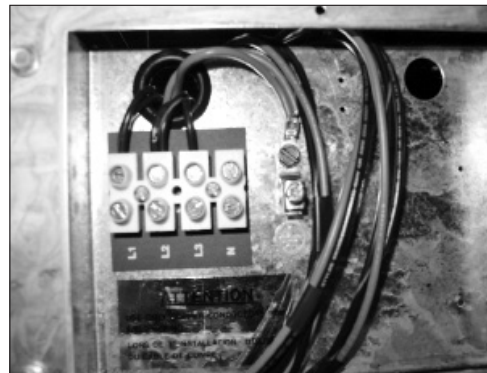

# WARNING

**Always disconnect electrical power to the machine before performing any adjustments or service.**

# Liquid Chemical Connection

In the left rear corner of the washer is the chemical injection assembly. This is where all chemical hose connections are made. The chemical hoses should be inserted into the round pvc pipe a minimum of 14" and a maximum of 18" to eliminate chemical buildup in the pipe and/or restrict water flow to the tub.



## Injection Source Details

The washer control may be programmed to send output signals for a chemical injection system. There is a separate terminal block for connection of the external injection signals. For the injection sources, program codes 0 through 6 are as shown in the table below. Injection signal will trigger a 120 volt reading at rear terminal block for approximately 5-10 seconds and will start to trigger at about 10-15 seconds after start of fill bath. (Chemical Injection Signals are shown in the programming section.)

**208/240 VAC  
Power Connections**

**Ground  
Connection**

**120VAC Injector  
Supply Connections  
Power Connections**

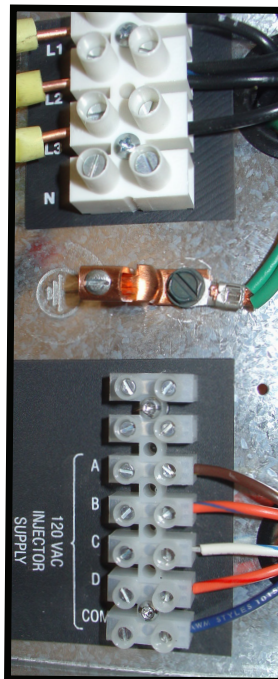

**L1  
L2  
L3  
N (not needed)**

**A  
B  
C  
D  
Common**

### Dexter Recommended Connections

Detergent  
Bleach  
Starch  
Sour/Softener

### Controller Programmed Signals

1  
2  
3  
4  
5  
6  
0

### Injection Terminal Block Connection

A  
B  
C  
D  
A and B  
C and D  
None

**Note :** The Wash Cycle programming mode will automatically exit and return to the Idle mode if no buttons are pushed for one minute.

# Dryer Installation

All commercial dryer installations must conform with local applicable local codes or in the absence of local codes, with the National Fuel Gas Code ANSI Z223.1A-1988. Canadian installations must comply with current standard CAN/CGA-B149(.1 or .2) Installation Code for Gas Burning Appliances or Equipment, and local codes if applicable. The appliance, when installed, must be electrically grounded in accordance with the National Electric Code, ANSI/NFPA No. 70-1990, or when installed in Canada, with Standard CSA C22.1 Canadian Electrical Code Part 1.

## Installation Clearances:

This unit may be installed at the following alcove clearances.

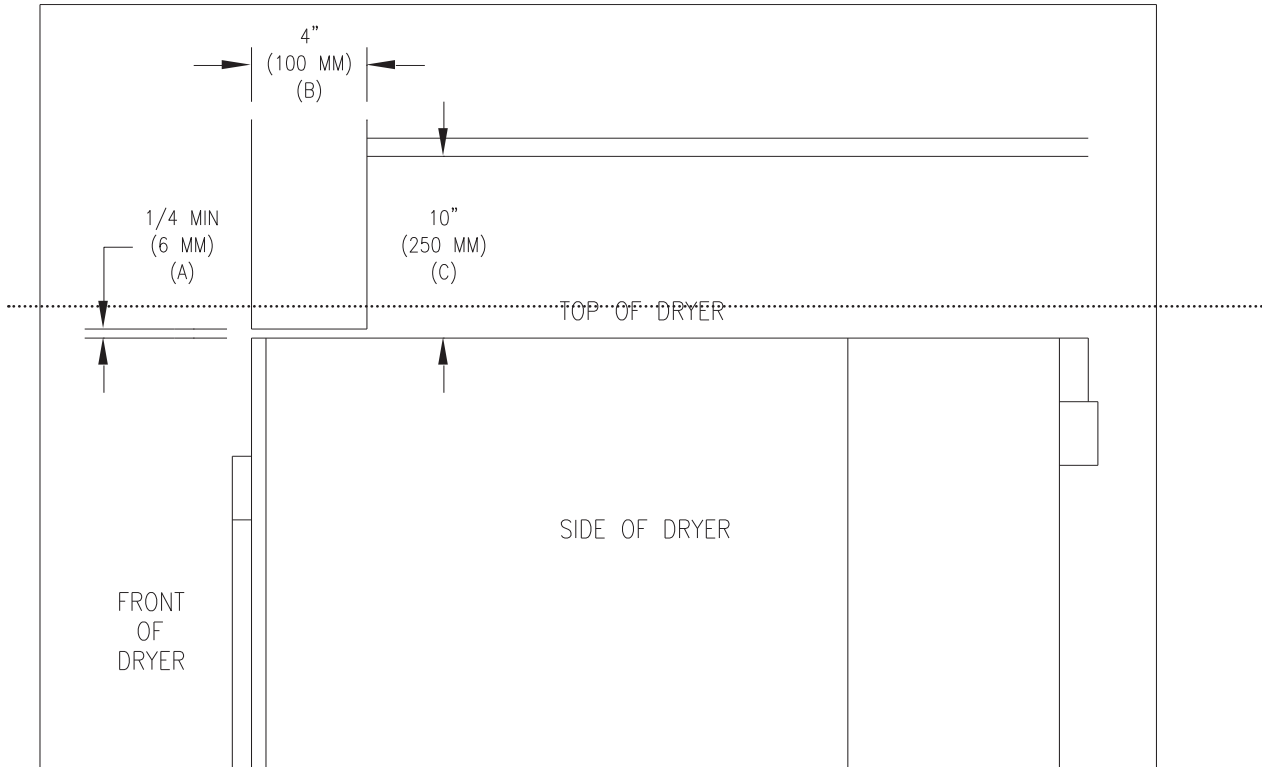

- |                |  |
|----------------|--|
| 1. Left side-  | 0"   |
| 2. Right side- | 0"   |
| 3. Back-       | 18" (Certified for 6" clearance: however 18" is required to clean, service, and maintain the dryer). |
| 4. Front-      | 48" to allow use of dryer.   |
| 5. Top-        | Refer to figure labelled "Vertical Clearance Dimensions".  |
| 6. Floor-      | This unit may be installed upon a combustible floor.   |

## Makeup Air

Adequate makeup air must be supplied to replace air exhausted by dryers on all types of installations. Provide a minimum of 1 square foot of makeup air opening to the outside for each dryer. This is a net requirement of effective area. Screens, grills or louvers which will restrict the flow of air must be considered. Consult the supplier to determine the free area equivalent for the grill being used.

The source of makeup air should be located sufficiently away from the dryers to allow an even air flow to the air intakes of all dryers. Multiple openings should be provided.

---

**NOTE:** The following considerations must be observed for gas dryer installations where dry cleaners are installed. The sources of all makeup air and room ventilation air movement to all dryers must be located away from any dry cleaners. This is necessary so that solvent vapors will not be drawn into the dryer inlet ducts. Dry cleaner solvent vapors will decompose in contact with an open flame such as the gas flame present in clothes dryers. The decomposition products are highly corrosive and will cause damage to the dryer ducts and clothes loads.

## Electrical Requirements

The electrical power requirements necessary to operate the unit satisfactorily are listed on the serial plate located on the back panel of each dryer. The electrical connection should be made to the terminal board on the rear of the unit using #10 AWG.

It is absolutely necessary that the dryer be grounded to a known ground. Individual circuit breakers for each dryer and washer are required. Use 15A circuit breakers for the 120V dryer. (See Dryer Specification Page for Electric Heated Models)

## Gas Requirements

The complete gas requirements necessary to operate the dryer satisfactorily are listed on the serial plate located on the back panel of the dryer. The inlet gas connection to the unit is 1/2 inch pipe thread. However, the size of the piping to supply the dryer should be determined by reference to the Fuel Gas Code and consulting the local gas supplier.

A joint compound resistant to the action of liquefied petroleum gases should be employed in making pipe connections. A 1/8 inch NPT plugged tapping, accessible for test gage connection, must be installed immediately upstream of the gas supply connection to the dryer.

All pipe connections should be checked for leakage with soap solution or leak detector. Never check with an open flame.

**CAUTION:** The dryer and its individual shutoff valve must be disconnected from the gas supply piping system during any pressure testing of that system at test pressures in excess of 1/2 psig. The dryer must be isolated from the gas supply piping system by closing its individual manual shutoff valve during any pressure testing of the gas supply piping system at test pressures equal to or less than 1/2 psig.

## Burner Set-Up

All gas burner manifolds should be checked for proper gas pressure while burning. Dryer burners should be set at 3.5 W.C. for Natural Gas while burner operating.

## Exhaust Installation

Exhausting of the dryer should always be planned and constructed so that minimum air restrictions occur. (Refer to Figure on dryer exhausting). Maximum static back pressure allowed at rear exit of dryer is .3 SBP.

Any restriction due to pipe size or type of installation can cause slow drying time, excessive heat, and lint build up in system and the room.

From an operational standpoint, incorrect or inadequate exhausting can cause cycling of the high limit thermostat which shuts off the main burners and results in inefficient drying.

Individual exhausting of the dryer is recommended. All heat, moisture, and lint should be exhausted outside by attaching a pipe of the proper diameter to the dryer adapter collars and extending it out through an outside wall. This pipe must be very smooth on the inside, as rough surfaces tend to collect lint which will eventually clog the ducts and prevent the dryer from exhausting properly. All elbows must be smooth on the inside. All joints must be made so the exhaust end of one pipe is inside the next one

downstream. The addition of an exhaust pipe tends to reduce the amount of air the blower can exhaust. This does not affect the dryer operation if held within practical limits. For the most efficient operation, it is recommended that no more than 14 feet of straight 6" diameter pipe with two right angle elbows be used for each cylinder. When more than two elbows are used, two feet of straight pipe should be removed for each additional elbow. No more than two right angle elbows should be used to exhaust each cylinder.

If the exhaust pipe passes through a wall, a metal sleeve of slightly larger diameter should be set in the wall and the exhaust pipe passed through this sleeve. This practice is required by some local codes and is recommended in all cases to protect the wall. This type of installation should have a means provided to prevent rain and high winds from entering the exhaust when the dryer is not in use. A hood with a hinged damper can be used for this purpose. Another method would be to point the outlet end of the pipe downward to prevent entrance of wind and rain. In either case, the outlet should be kept clear by at least 24" of any objects which would cause air restrictions.

Never install a protective screen over the exhaust outlet.

When exhausting a dryer straight up through a roof, the overall length of the duct has the same limits as exhausting through a wall. A rain cap must be placed on top of the exhaust and must be of such a type as to be free from clogging. The type using a cone shaped "roof" over the pipe is suitable for this application. Exhausting the dryer into a chimney or under a building is not permitted. In either case there is a danger of lint buildup which can be highly combustible.

Installation of several dryers where a main discharge duct is necessary, will need the following considerations for installation. Whether using the 8" exhaust kit or individual 6" ducts, entrance into the main discharge duct should be at a 45 degree angle in the direction of discharge air flow.

**NOTE:** A small diameter duct will restrict air flow, a large diameter duct will reduce air velocity, both contributing to lint build up, An inspection door should be provided for periodic clean-out of the main duct.

**NOTE:** STATIC BACK PRESSURE should be a maximum of 0.3 in. w.c (7.6 mm w.c) at the rear exhaust outlet of the dryer. If multiple dryers are connected to the common duct, ensure the back draft damper is installed properly.

**NOTE:** The following illustration shows the various round main duct diameters to use with the individual dryer ducts. The main duct can be rectangular or round, provided adequate air flow is maintained. For each individual cylinder the total exhausting (main discharge duct plus duct outlet from the dryer) should not exceed the equivalent of 14 feet and two elbows. The diameter of the main discharge duct at the last dryer must be maintained to exhaust end.

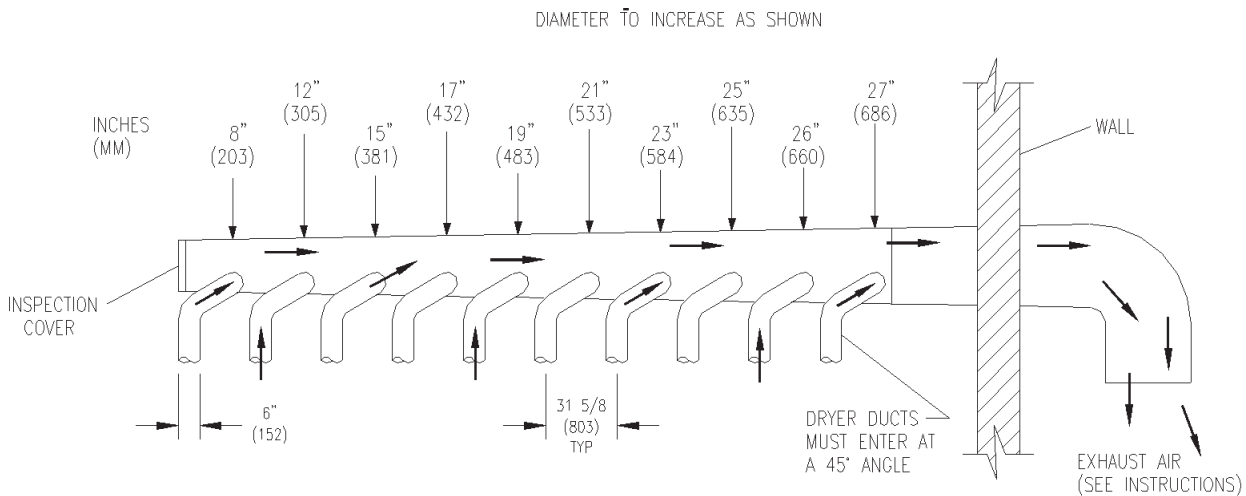

---

# Washer Operating Instructions

## Safety Door Lock

This machine is equipped with a Safety Door Lock that locks the door closed from when the cycle is started until the cycle is complete. The door lock prevents opening the door for up to 3 minutes if the power is interrupted during the cycle.

## Microprocessor

Prior to operation, the micro computer should be set to display the amount of vend price being offered and the cycle to be given to the user. NOTE: Should a power loss occur during cycle and when power returns, P U S H will be displayed in window and customer must push the START button to continue the cycle.

## Starting the Washer

- A. Load the items to be washed in the cylinder and latch the door securely. Be sure clothing does not get caught between the door gasket and tub front when closing the door.

NOTE: To close the door the handle must be in the horizontal position and then moved to the vertical position. After moving the door to the closed position, the handle must be turned down to the vertical position to latch the door for machine operation.

- B. Make the appropriate cycle selection for the wash load by pushing the up and down arrows on the touch pad. Preprogrammed Cycles 1,2,3,4,5, or 6. Each cycle is completely programmable and for instructions see next section in this manual.
- C. To manually add wash compounds, pour low-sudsing powdered detergent into the detergent dispenser on front of the machine. Rinse conditioners may also be added to the dispenser. The correct location of each is shown on the dispenser lid.
- D. To manually add bleach in Rinse, pour bleach in opening. Bleach light will come on during the wash bath only (location shown on dispenser lid) in top or front of washer.
- E. To start the washer, push the green "Start" button
- F. To pause for an extended soak, push the red Stop button for 1 second. To continue the cycle, push the green Start button. enough to reach down to water trap.
- G. To stop and clear the wash cycle, hold the red Stop button for 8 to 10 seconds.
- H. If automatic chemical injection systems are being used, make sure that chemical hoses are inserted correctly in the injection port located at rear corner at red cover. Hoses must be inserted long enough to reach down to water trap.

### Detergent Measurements



Triple Load SWD Washer

---

### **Safety Door Lock**

If power is interrupted the Safety Door Lock delays opening the door until it is safe to do so. If power failure occurs or if power is interrupted during maintenance, it will be necessary to wait 2 to 3 minutes before the door can be opened.

### **End of Cycle**

When the cycle is completed, the washer will stop, the End of Cycle Light will come on, the Buzzer sounds and the loading door will unlock. It can be opened by turning the door handle to the indicated position and pulling. Leave the clothes door open when the machine is not in use helps to eliminate odors that might build up during the wash process.

## **Dryer Operating Instructions**

1. Load clothes into the tumbler and close the door. The clothes should be well separated. Untangling following washing may be necessary for best drying.
2. Set the temperature selector to the desired setting for the type of clothes to be dried.

### **LOAD**

Delicate  
Perma-Press/ Personal  
100% Cottons

### **TEMPERATURE**

Warm  
Medium  
Hot

3. Set the drying timer for the time estimated to dry the load of clothing.
4. Set the cool-down timer for the desired cool-down time.
5. Press the start switch and hold momentarily until dryer reaches operating speed.

**IMPORTANT:** Normally, dryer operation will continue uninterrupted through the complete cycle determined by number of minutes set on timer. However, opening the loading door will interrupt the circuits and the drive motor and main burners will cease to function. The signal light will remain on and the time cycle will continue independent of the interruption until expiration of the time on the timers or until drying cycle is resumed by closing the door and restarting the dryer to continue drying the clothes. Either the drying timer or the cool-down timer may be canceled at any time by turning the knob counterclockwise to "off".

### **Characteristics of running dryer:**

Temperature selection may be changed at any time with the dryer running.

Running time may be extended any time that while the dryer is running if desired.

---

# Dryer Timer Control / Operation

## Dry Time Timer

The dry time timer sets the drying time only and does not include the cool-down time. However, for safety there is an automatic cool down of 2 minutes minimum built into the cycle even when none is called for by the cool down timer.

## Cool Down Timer

The cool down timer sets the cool down time for the cycle. This time is added to the time placed on the main cycle timer.

## Adjustable Thermostat

The thermostat knob allows you to set the desired temperature range for the particular load being dried.

## Push to Start Switch

The push-to-start switch must always be pushed to start a stopped tumbler. (At least one of the timers must have time placed on it and the loading door must be closed for tumbler motion to occur).

## On Light

The ON light is built in to the push-to-start button. It indicates that time has been added to at least one of the timers.

## TRANSIENT VOLTAGE SURGE SUPPRESSORS

Like most electrical equipment your new machine can be damaged or have its life shortened by voltage surges due to lightning strikes which are not covered by factory warranty. Local power distribution problems also can be detrimental to the life of electrical components. We recommend the installation of transient voltage surge suppressors for your new equipment. These devices may be placed at the power supply panel for the complete installation and don't require an individual device for each machine.

These surge protectors help to protect equipment from large spikes and also from small ongoing spikes in the power that occur on a day to day basis. These smaller surges can shorten overall life of electrical components of all types and cause their failure at a later date. Although they can't protect against all events, these protective devices have a good reputation for significantly lengthening the useful life of electronic components.

Electronic Components are helped to have a longer useful life when they are supplied with the clean stable electrical power they like.

We are including the following names and links to a few suppliers of these devices for those who don't currently have a source.

MANUFACTURER	LINK
MCG Surge Protection	<a href="http://mcgsurge.com">mcgsurge.com</a>
Eaton Corporation	<a href="http://eaton.com/us/en-us">eaton.com/us/en-us</a>
Schneider Electric	<a href="http://se.com/us/en">se.com/us/en</a>
Asco Power Technologies	<a href="http://ascopower.com/us/en">ascopower.com/us/en</a>
Emerson Electric Co.	<a href="http://emerson.com/en-us">emerson.com/en-us</a>

---

# **Section 3:**

Washer  
Programming  
Instructions

---

# Washer Programming Instructions

## THERE ARE TWO WAYS TO MODIFY PROGRAMMING OF THE V-SERIES OPL SIX (6) PREPROGRAMMED FORMULAS

**Option 1:** Programming can be accomplished manually using the machine controls or by connecting to the machine control using a PDA (personal digital assistant). For instructions on using a PDA with this washer control and software, please contact your local Dexter distributor. Please read below for manual programming instructions.

The keypad layout for the washer control is shown below.

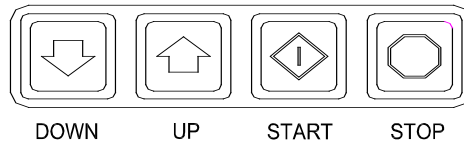

### Option 2: Wash Cycle Manually Programming

1. Turn on the power to the washer.
2. Turn the Run/Program key to the Program position. Display will show "CO" and the "ADD BLEACH" will blink and will continue to blink during the programming mode.
3. Press the "DOWN" or "UP" buttons to select which cycle to alter. When the desired cycle number is displayed, press "START".
4. The display should now show a "b". The "b" and the cycle indicator lights indicate which bath is being selected to alter. Press the "UP" and "DOWN" buttons to select a bath to change and then press "START".



The indicator lights are shown above:

When "RINSE" is selected, "b r1" through "b r4" may be selected.

**There may be multiple rinses that are indicated by br 1, br 2, br 3, and br 4**

5. Each bath can be programmed with the following options. Use the "DOWN" and "UP" keys to select the desired setting and the "START" key to move to the next option.

To exit the programming of a bath, press the "STOP" button once and use the "UP" and "DOWN" keys select another bath. Press the "STOP" button again to select a different cycle to change. To end programming, turn the key to "RUN" position.

---

## Washer Cycle Parameter Ranges

The range of each cycle parameter is shown below:

<b>Bath Cycle Time "ct"</b>
0 to 15 minutes for Prewash, Rinse1 and Rinse 3 to 15 minutes for Wash and Final Rinse. For the baths that can, if the time is set to zero, then that bath will be eliminated from the cycle.
<b>Bath Water Temperature "t"</b>
HH – hot, CH – warm, CC – cold, EE – no water. The owner can set the bath default. For the wash bath, the default is over ridden for that cycle by the customer when the temperature is selected.
<b>Bath Water Level "L"</b>
LO – low The owner can change the displayed value, but for a coinwasher only LO will be put into the cycle.
<b>Bath Delay Fill "dF"</b>
The selections are "d" for delay the bath time until water level is reached or "t" for decrement bath time during the fill.
<b>Bath Spin Time "S"</b>
0 to 10 minutes for Prewash, Wash, Rinse1 and Rinse2 1 to 10 minutes for Final Spin.
<b>Bath "IS"</b>
The owner can change the displayed value, but for a coin washer only 0 will be put into the cycle.

## Washer 6 Default Cycles (Preset at Factory)

There are 6 pre programmed baths on the control which are set up at the factory. The formulas for each are shown on the following pages. Each of these 6 programs can be adjusted and saved as the owner needs.

**Cycle 1: Sheets and Pillowcases (Health Care)**

<b>Bath</b>	<b>Bath Cycle Time (min.)</b>	<b>Water Temp.</b>	<b>Water Level</b>	<b>Delay Fill</b>	<b>Spin Time (min.)</b>	<b>Injection Source</b>
Flush	3	CH	HI	d		
Prewash	2	CH	HI	d		
Wash	7	HH	LO	d	1	#1(Detergent)
Rinse 1	7	HH	LO	d	2	#2 (Bleach)
Rinse 2	2	CH	HI	d	1	
Rinse 3	2	CH	HI	d		
Rinse 4						
Final Rinse	4	CH	LO	d	4	#4 (Sour/Soft)

**Cycle 2: Towels / Pads / Diapers (Health Care)**

<b>Bath</b>	<b>Bath Cycle Time (min.)</b>	<b>Water Temp.</b>	<b>Water Level</b>	<b>Delay Fill</b>	<b>Spin Time (min.)</b>	<b>Injection Source</b>
Flush	3	CH	HI	d		
Prewash	2	CH	HI	d		
Wash	7	HH	LO	d	1	#1 (Detergent)
Rinse 1	1	HH	HI	d		
Rinse 2	7	HH	LO	d	2	#2 (Bleach)
Rinse 3	2	CH	HI	d	1	
Rinse 4	2	CH	HI	d		
Final Rinse	4	CH	LO	d	5	#4 (Sour/Soft)

**Cycle 3: White Towels (Hotel / Motel)**

<b>Bath</b>	<b>Bath Cycle Time (min.)</b>	<b>Water Temp.</b>	<b>Water Level</b>	<b>Delay Fill</b>	<b>Spin Time (min.)</b>	<b>Injection Source</b>
Flush						
Prewash						
Wash	7	HH	LO	d	1	#1(Detergent)
Rinse 1	1	HH	HI	d		
Rinse 2	7	HH	LO	d	2	#2 (Bleach)
Rinse 3	2	CH	HI	d	1	
Rinse 4	2	CH	HI	d		
Final Rinse	4	CH	LO	d	5	#4 (Sour/Soft)

Cycle 4: Guest Laundry (Hotel / Motel / Healthcare)						
Bath	Bath Cycle Time (min)	Water Temp.	Water Level	Delay Fill	Spin Time (min)	Injection Source
Flush	3	CH	HI	d		
Prewash						
Wash	7	HH	LO	d	5	#6(Detergent/Bleach)
Rinse 1	2	HH	HI	d		
Rinse 2	2	CH	HI	d		
Rinse 3	2	CH	HI	d		
Rinse 4						
Final Rinse	4	CH	LO	d	4	#4 (Sour/Soft)

Cycle 5: Rags and Mops (Hotel / Motel)						
Bath	Bath Cycle Time (min)	Water Temp.	Water Level	Delay Fill	Spin Time (min)	Injection Source
Flush	3	CH	HI	d		
Prewash	2	CH	HI	d		
Wash	2	CH	HI	d		
Rinse 1	7	HH	LO	d	1	#1 (Detergent)
Rinse 2	2	HH	HI	d		
Rinse 3	7	HH	LO	d	2	#2 (Bleach)
Rinse 4	2	CH	HI	d	1	
Final Rinse	2	CH	LO	d	5	

Cycle 6: Colored Cotton Linen (Hotel & Food Service)						
Bath	Bath Cycle Time (min)	Water Temp.	Water Level	Delay Fill	Spin Time (min)	Injection Source
Flush	3	CH	HI	d		
Prewash	2	CH	HI	d		
Wash	2	CH	HI	d		
Rinse 1	7	HH	LO	d	1	#1(Detergent)
Rinse 2	2	HH	HI	d		
Rinse 3	7	HH	LO	d	2	#2 (Bleach)
Rinse 4	2	CH	HI	d	1	
Final Rinse	2	CH	LO	d	5	

## Rapid Advance Mode

To enter the Rapid Advance mode, turn the key CCW. The Rapid Advance setting is not marked next to the key, but turning the CCW until it stops selects this mode. The Rapid Advance mode can be entered from either the Idle mode or during the cycle. If the cycle has not yet started, press the "START" button. To rapid advance to the next step in the wash cycle, push both the "UP" and "START" buttons at the same time. The display will show an "Ad" (advance) in the display. The washer will advance to the next bath segment. The water will drain before the advance will occur and the time displayed may not be accurate.

- Notes:**
- The indicator lights will show to which segment the cycle has been advanced.
  - The cycle will continue in rapid advance mode even if the key is turned to "RUN" and/or removed.
  - Rapid advance cannot skip the final 1- minute tumble of the cycle, and the door lock may remain activated for up to 3 minutes after the cycle has been completed.
  - Chemical 120 volt signals will be lost after Rapid advance Mode has been activated until cycle resets. To exit the Rapid Advance mode, push and hold the STOP button.

## Injection Source Details

The washer control may be programmed to send output signals for a chemical injection system. There is a separate terminal block for connection of the external injection signals. For the injection sources, program codes 0 through 6 are as shown in the table below. Injection signal will trigger a 120 volt reading at rear terminal block for approximately 5-10 seconds and will start to trigger at about 10-15 seconds after start of fill bath.

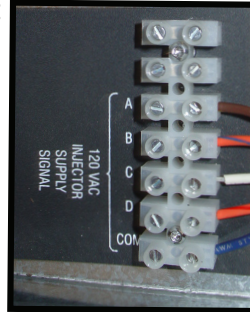

### Dexter Recommended Connections Circuits

### Controller Programmed Signals

### Injection Terminal Block

Detergent	1	A
Bleach	2	B
Starch	3	C
Sour/Softener	4	D
	5	A and B
	6	C and D
	0	None

**NOTE: The Wash Cycle programming mode will automatically exit and return to the Idle mode if no buttons are pushed for one minute.**

### 2.11.3 CONTROLS TRANSFORMER (208-240V 60 Hz models only)

The controls transformer is located inside the control trough and steps a range of 208 to 240 volts down to 115 volts. There are two terminals on the controls transformer for the primary (incoming) power. Use the terminal marked "208V" for power supplies between 208 and 219 volts. Use the terminal marked "240V" for power supplies between 220 and 240 volts. Refer to the following for control transformer connections.

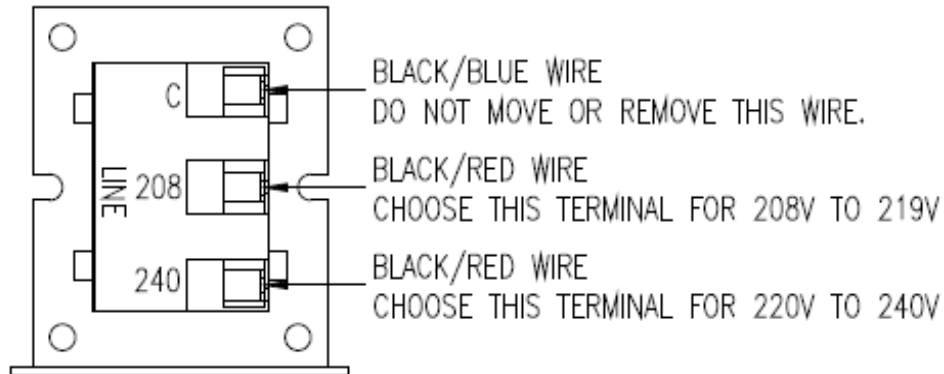

#### 60 Hz Control Transformer Connections

### 2.11.4 CONTROLS TRANSFORMER (230V 50 Hz models only)

The controls transformer is located inside the control trough and steps a range of 180 to 255 volts down to 24 volts. There are two terminals on the controls transformer for the primary (incoming) power. Use the terminal marked "L1 200V" for power supplies between 180 and 229 volts. Use the terminal marked "L1 230V" for power supplies between 230 and 255 volts.

#### CONTROL TRANSFORMER CONNECTIONS

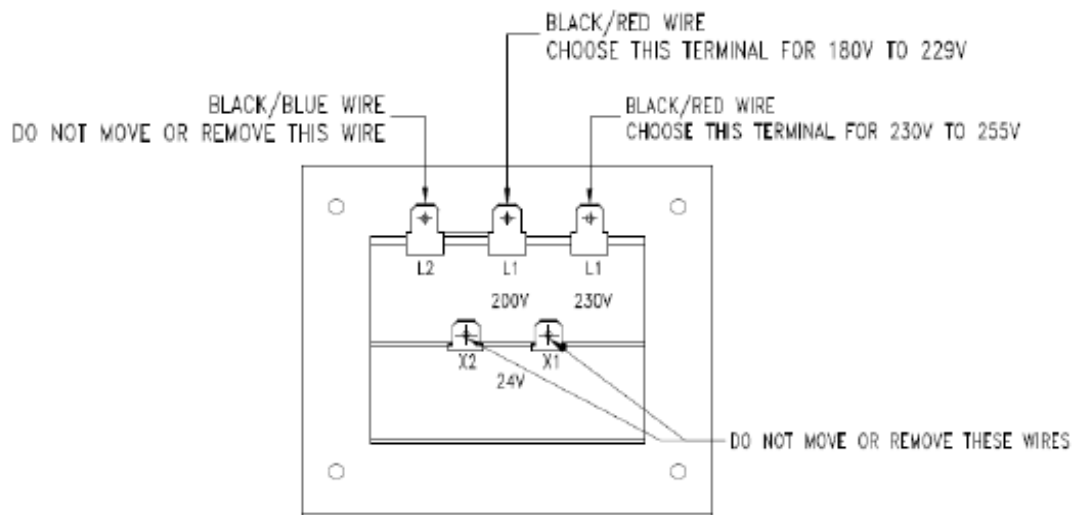

#### 50 Hz Control Transformer Connections

### 2.11.5 MAXIMUM SPIN SPEED ADJUSTMENT (All washers except T-950)

If desired, the washer can be adjusted to limit the maximum extract spin speed for all wash cycles.

To make this adjustment, a jumper wire must either be installed or removed on the Variable Frequency Drive (VFD), depending on the washer model and desired speed. This Dexter jumper part number 8220-057-036 (qty 1) is factory supplied on terminal points "10V" and "RC". Remove this jumper to make new jumper connections if necessary. Refer to figure below for the approximate location of the control terminations on the Variable Frequency Drive (VFD) and for appropriate jumper connection points indicated with an "X" for the desired maximum spin speed setting. If no adjustment to the default spin speed is desired, do not remove or add any wires on VFD.

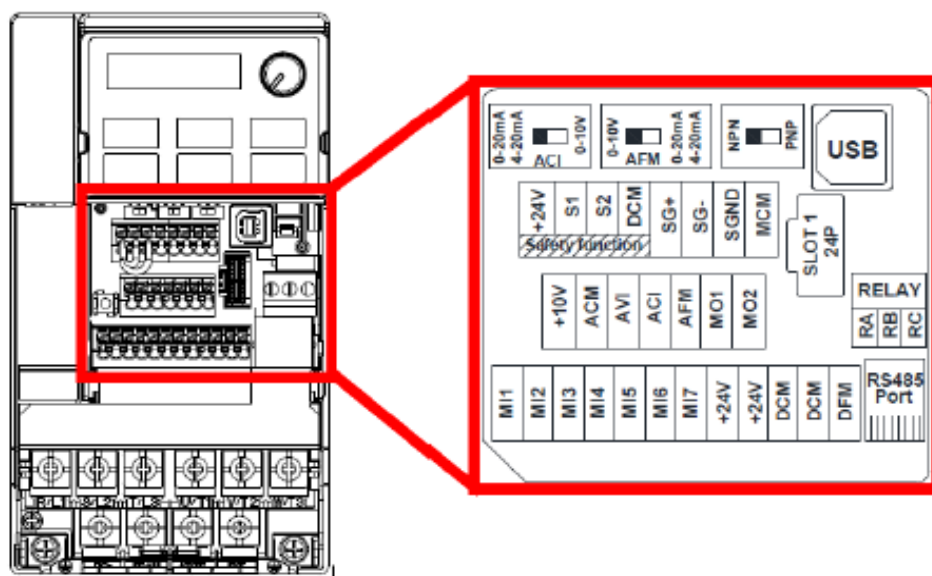

**Control Terminations on Variable Frequency Drive**

V Series Washer Model	Max Spin Speed	Jumper Terminal Locations on Variable Frequency Drive (VFD)													
		MI1	MI2	MI3	MI4	MI5	MI6	DCM (Left)	DCM (Right)	24V	ACM	AVI	ACI	10V	MO1
T-300, T-400,	60 G											X		X	
T-600, T-900,	80 G				X			X							
T-1200	100 G	Default Setting (No Jumper Required)													
T-350, T-450, T-750	60 G											X		X	
	100 G				X			X							
	140 G					X		X							
	200 G	Default Setting (No Jumper Required)													
T-650, T-1450	100 G											X		X	
	140 G	REMOVE Brown Jumper Between MI5/MO1													
	200 G	Default Setting (No Jumper Required)													

**Spin Speed Adjustment Jumper Locations**

**MAXIMUM SPIN SPEED ADJUSTMENT (T-950 Only)**

The variable frequency drive allows for varying acceleration during Final Spin on T-950 models. It is important to utilize a decreased acceleration rate when the application power is low. This acceleration rate is determined by a white wire jumper installed on the drive terminal block from +10V to AVI.

Remove the wire jumper when input power is between 208 and 219 volts. Keep the jumper installed when input power is between 220 and 240 volts. Reference the drawing below for the jumper location.

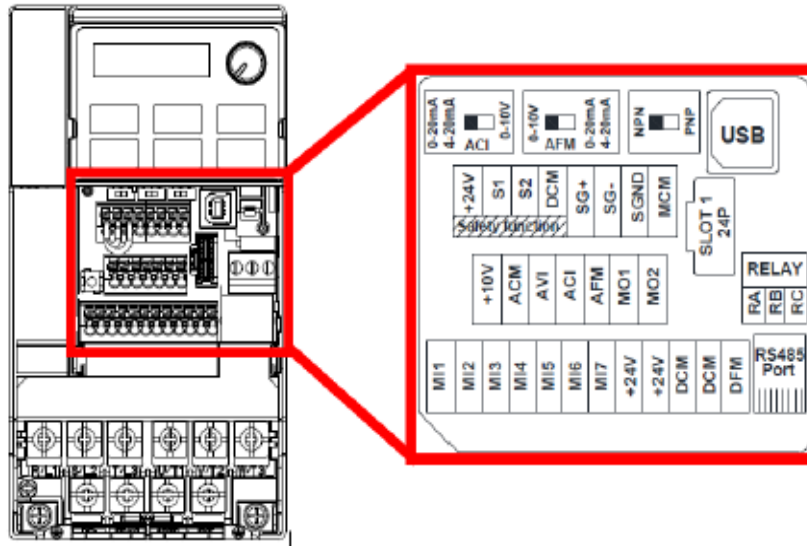

**Control Terminations on Variable Frequency Drive**

V Series Washer Model	Input Voltage	Max Spin Speed	Jumper Terminal Locations on Variable Frequency Drive (VFD)													
			MI1	MI2	MI3	MI4	MI5	MI6	DCM (Left)	DCM (Right)	24V	ACM	AVI	ACI	10V	M01
T-950	240V	140 G	REMOVE Brown Jumper Between MI5/M01													
		200G												X		X
	208V	140 G	REMOVE Brown Jumper Between MI5/M01													
		200G	No Jumper required													

**T-950 Spin Speed Adjustment Jumper Locations**



---

# **Section 4:**

Dryer Service,  
Trouble Shooting  
and Schematics

---

# Service Procedures

## Clothes Door Removal

1. The clothes door may be removed from the hinge bracket by unscrewing and removing the allen-head pivot screw located at the door upper hinge point.
2. Next lean the door out of the top of the hinge bracket and lift the door from the bottom hinge pin.

NOTE: the spacer between the bottom of the door and the hinge.

## Clothes Door Latch Adjustment

1. Loosen the lock nut on the latching stud. It is located directly behind the door handle.
2. Open the loading door.
3. Screw the door catch stud in or out as necessary and then retighten the lock nut.

## Door Switch Removal And Installation

1. Each door switch is located directly behind the hinge plate of the loading door assembly.
2. The entire switch can now be pulled from the front panel opening.
3. The switch has two clips that hold it in place on the rear of the switch.
4. With the panel removed, you can now squeeze the two clips and allow switch to be pushed back through panel and grasped from the front and switch removed.

## Installation Of Clothes Door Window And Gasket

1. Place the clothes door, with its face down, on a solid surface.

NOTE: Prewarming the gasket makes the installation much easier.

2. Install the window gasket on the clothes door flange. The wider lip of the gasket should be on the bottom side or front face of the clothes door and the ridges should be up.
3. Locate the seam at the latching stud.
4. Apply a soapy water solution or rubber lubricant to the gasket.
5. Slide the glass into the middle of the door ring and gasket with half of the glass above the door and half below.
6. While pressing down on the glass, stand the door up and use a modified screw driver with the end rounded off to install half of the glass. Lay the door down and install the other half.
7. At the six o'clock position, pry the glass up enough to install the black spacer. (reuse from old door gasket)

## High Limit Thermostat Locations And Functions

**A. Burner Housing-** This hi-limit is located on the back side of each burner housing.

1. The thermostat opens the circuit to the main burners in the event of malfunction in the gas control area or temperature control. This thermostat will open quickly if there is a significant loss of air flow over the burner area.
2. It is covered by a guard and is held in place by two screws. There are spacers between the thermostat and bracket which must be used to give proper operation.

**B. Manual Reset Over temperature Safety Thermostats-** The manual over temp thermostat is located on the right side of each burner housing as you view from the back of the machine. It is just above the gas valve and covered by a guard with a small access hole.

1. The manually resettable thermostat limits the operating temperature a dryer can reach should some abnormal situation occur.

- 
2. Should one of the thermostats be tripped, the tumbler will cease to heat until the thermostat is reset. Once the dryer cools, the thermostat may be reset by inserting a pencil or stick through the opening in the thermostat cover.

**REMOVAL:** To remove either the hi-limit thermostat on the rear of the burner housing or the over-temperature thermostat on the right side of the burner housing, remove the mounting screws holding its respective guard. Next, remove the terminal of each wires attached to the thermostat. Lastly, remove the mounting screws holding the thermostat to the burner.

### **Pressure Regulator Adjustment**

Use the following procedure whenever it is necessary to check the pressure regulator setting.

NOTE: Any adjustment of the pressure regulator must be made with a manometer attached at the plug in the main burner manifold.

1. Shut off the gas supply to the dryer.
2. Remove the 1/8" pipe plug from the end of the main burner manifold.
3. Attach a manometer to the manifold end.
4. Remove the pressure regulator cover screw on the gas valve.
5. Open the shutoff valve, and operate the dryer.
6. Adjust the pressure for a manometer reading of 3.5" water column gas pressure. (11.0" for L.P.)

NOTE: The main burners must be operating when adjusting the pressure regulator.

7. Shut off the gas supply to the dryer. Remove the manometer and install the 1/8" pipe plug in the manifold.
8. Open the shut off valve, start the dryer and check for gas leaks while the burners are ignited.

### **Temperature Sensor**

This unit is the regulating thermostat on the mechanical timer dryer. The function of the Heat Sensor is fairly simple. As the temperature goes up, the resistance in the thermistor (heat sensor) goes down. As the temperature drops, the resistance in the thermistor (heat sensor) goes up.

### **Upper Front Panel Removal**

The loading door does not have to be removed to remove the front panel on this model.

1. Remove the left two screws with finish washers.
2. Remove the right two screws with finish washers, at this time the front panel is loose but connected by the harness to the door switch.

**NOTE:** Always remove power from the machine before changing drive belts or working with the drive system.

### **Final Drive Belt Replacement**

To replace the final drive belt turn the cylinder slowly by hand and work the belt off of the large pulley.

### **Motor Drive Belt Replacement**

To replace the motor drive belt the final drive belt should be removed as above. Cut the old motor belt and remove. The new motor drive belt fits inside of three of the four motor mounting bolts. To achieve this,

---

remove these three bolts one at a time and slide the belt in past each in turn. In this way the motor is always supported by 3 bolts at any time.

NOTE: All drive belts are self adjusting.

### **Tumbler Pulley Removal And Installation**

Remove the 1 1/2" nut and lock washer. Pull the pulley off the shaft. Watch for the locking key on the tumbler shaft. Upon installation, the tumbler nut should be torqued to 150 ft./lbs.

### **Intermediate Pulley And Tension Arm Removal**

1. The intermediate pulley is retained with a snap ring. Remove the snap ring and the pulley slides off the shaft.
2. With the pulley off, there is access to the self adjusting tension arm assembly. The tension arm assembly may be removed by removing the snap ring that holds it to the tension arm support assembly pin. The arm assembly is replaced as a complete unit.
3. The grease fitting for the intermediate shaft should be greased monthly.

### **Tension Arm Support Assembly Adjustment**

The tension arm support assembly may be adjusted for alignment of the intermediate pulley and also to align the belts. The three outer nuts allow the alignment of the pin to be adjusted by pivoting the assembly on the center bolt. The center bolt can be screwed in to allow bringing the complete assembly farther back if necessary for belt alignment.

### **Motor Blower Assembly Removal And Installation**

1. Remove the motor wiring cover and take the 3 motor wires off.
2. Remove the 9 nuts and lock washers that retain the blower cover and set assembly out of dryer.
3. The blower is held in place with 2 square headed set screws. Upon reassembly, one blower set screw should fit in the counter sink in the shaft and the other set screw should go against the flat side of the shaft. Use red Loctite on the set screws and torque to 165 in./lbs.
4. The motor is mounted with 4 bolts to the motor mounting bracket on rear of dryer.

### **Air Flow Switch Operation And Adjustment**

The air flow switch assembly is part of the ignition safety circuit and insures that the burners don't operate unless there is air flow. When the drive motor and blower are running the flat actuator is pulled in against the back of the dryer closing the switch. If this doesn't happen ignition will not occur. The air flow switch assembly is mounted by two screws through the bracket. It can be adjusted by loosening these mounting screws and moving the switch forward or backward.

### **Ignition Transformer Fuse**

The 1 1/2 amp fuse protects the ignition transformer. To remove it just twist and pull it out.

---

## Ignition Control Transformer

When heat is called for, the ignition control transformer steps 120VAC down to 24VAC to power the ignition control.

## Electronic Ignition Module

This machine uses an electronic spark ignition system to directly light the burners in each tumbler.

1. The electronic ignition module for the tumbler is located inside the electrical box. This is the metal box on the back of the tumbler area directly to the right of the final drive pulley.
2. The red wire from the transformer traveling thru the 1.5 amp fuse and into the module supplies the 24VAC required to operate the entire direct ignition system.
3. The black colored hi-voltage wire (spark plug type) plugs onto the post connector on the module, and the multi-wire plug fits into the side of the module.

## Spark Ignition Module Removal

If the ignition modules are mounted on a bracket, see section A. Otherwise, see section B.

### A: With mounting bracket

Remove the connector housing of the wiring harness attached to the ignition module. Then, remove the terminal of the hi-voltage cable attached to the ignition module. Next, remove the mounting screws holding the ignition module mounting bracket in the rear control box. Lastly, remove the nuts holding the ignition module on its mounting bracket.

### B: Without mounting bracket

Remove all of the terminals of the wiring harness attached to the ignition module. Then, remove the terminal of the hi-voltage cable attached to the ignition module. Lastly, remove the mounting screws holding the ignition module in the control box. If there is no spark or intermittent spark, check black hi-voltage lead wire for damage

NOTE: Proper grounding of the ignition system (yellow wires) is very critical for proper ignition sequence.

## Ignition System-Function & Sequence

During normal dryer operation, the following occurs:

1. The dryer thermostat calls for heat.
2. If the drive motor is running, the motor safety circuit provides power to the electronic control. If the control senses that the heat should be on, a circuit is closed allowing power through the high limit thermostat and air flow switch to the ignition transformer. The transformer provides 24VAC to the ignition module and sparking occurs at the ignition electrode. At the same time 24VAC is applied to the gas valve.
3. Once the flame is established, the sensing electrode detects the presence of flame and the sparking stops.
4. If for any reason the flame is not established in a period of 10 seconds, the electronic control will try this sequence for 3 tries. Normally the 10 seconds "Trial For Ignition" period is ample to establish and prove flame.



- If the flame is shutdown or blown out during operation, the ignitor will immediately go into "Trial For Ignition" again for 10 seconds.
- However, at the end of 3 separate retries of 10 seconds "Trial for Ignition", the flame is not established, the ignition system goes into "Safety Lock-Out" and will not reactivate the "Trial for Ignition" until there is a current interruption for a period of 15 seconds. This interruption can be provided by opening the dryer loading door and allowing the machine to come to a complete stop for 15 seconds.

### Ignition System-Checkout

- If flame is present during "Trial For Ignition" period but the system shuts down, there may be an improper ground. The entire ignition system is grounded together including the electrode assembly, the electrode mounting bracket, the burners and the burner bracket. Shutdown can also occur if for some reason the system isn't sensing the flame. Check the sensor for damage and check the connections of the sensor lead.
- If there is no spark or intermittent spark, check black hi-voltage lead wire for damage or cracks in insulation. (This lead wire must not be taped or connected to any metal edges along its length to prevent pinching and arcing. Also, do not bundle this wire with other wires.)

NOTE: Spark gap and electrode location are important. If the electrode is damaged or mounting is changed the spark gap may not be correct for ignition to occur. Check for cracks in the ceramic insulator. Replace electrode assembly if necessary. Also check for carbon or foreign material on the electrodes and clean if necessary.

### Spark Electrode Assembly-Removal

- Remove electrode cover and disconnect wires to electrodes.
- Remove two screws to detach electrode assembly.

### Gas Valve Removal (shut off manual gas valve to stop gas flow before removing gas control valve)

- Disconnect union at gas valve and disconnect wires from gas valve operator coils.
- Remove right manifold mounting bracket screws and slide manifold to remove from left bracket.

### Main Burner Orifice Removal

- Remove manifold and gas valve assembly as above.
- Using an open end wrench, remove orifices from manifold.

### Main Burner Removal

- Remove the 4 screws securing the cover for the burner housing and the one screw mounting the high limit cover. With the burner housing cover removed, there is complete access to the burner assemblies.

### Recirculation Chamber Inspection

- Remove Resettable manual overtemp sensor and remove inspection plate in burner chamber between main burners and rear back panel of

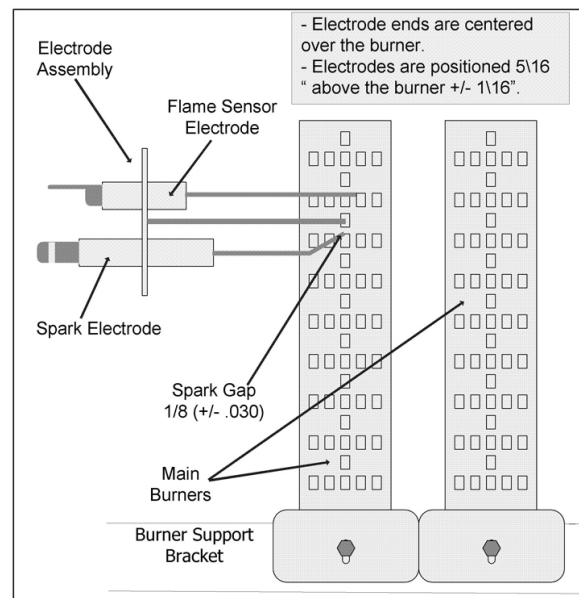

---

dryer.

### **Cylinder Removal**

1. Remove the front panel in front of the cylinder.
2. Remove drive belt, pulley, and key from cylinder shaft.
3. Pull the cylinder from the front of the machine.

### **Adjustment Of Cylinder Assembly With Front Panel Removed**

1. Loosen the two top adjusting bolts and two bottom adjusting nuts and lock nuts holding the bearing housing to the drive plate.
2. Loosen the four mounting bolts on the side channels.
3. Open the clothes door and insert a 1/4" thick shim at the 3 and 9 o'clock positions and a 1/8" thick shim at the 6 o'clock position.
4. Tighten the two bottom adjusting nuts and tighten locking nuts.
5. Tighten the bottom right mounting bolt, then the top left mounting bolt. Tighten the remaining two bolts. (Shim where and if necessary.)
6. Tighten the two top adjusting bolts.
7. Remove all the shims from between the front panel flange and cylinder (3, 6, and 9 o'clock).8. Spin the cylinder to check for rubbing baffles, pressing down hard while rotating. If rubbing is detected, repeat procedure paying particular attention to placement of shims between bearing housing and side channels.

### **Tumbler Through Bolt Access Cover**

Remove 4 screws that mount the air flow switch to the back of the dryer. Remove 2 screws that retain access cover. With access cover removed, tightness on the tumbler through bolts can be checked and tumbler alignment can be adjusted.

### **Bearing Housing Removal**

After removing cylinder as previously outlined, simply unbolt the bearing housing and remove.

# Dryer Trouble Shooting

Symptom	Probable Cause	Suggested Remedy
Tumbler does not turn	Drive belts	Check both drive belts. Replace if failed.
	Tumbler does not turn	Check capacitor and motor. Replace if failed
	Door switch	Check door switch contacts and adjustment. Adjust or replace door switch.
	Timer Tumbler does not turn	Check to see if heat timer is turned on
Tumbler turns but no spark at burner	Glass fuse	Check small glass control fuse in back of dryer. Replace if failed.
	Thermostat	Check if voltage is passing through the two wires attached to the temperature thermostat
	Ignition	Check for 24VAC output from transformer.
	Transformer	Replace if have 120V between black & white and no 24V between red and yellow.
	Over temperature	Check to see if manually resettable thermostat. Thermostat is kicked out. Reset by pushing red reset button.
	Ignition control	Check for 24VAC coming into the control on the at burner red wire. If voltage, then check for 24VAC out on the brown wire. Also check for spark at the ignitor. If no 24VAC output or no spark to the ignitor, replace ignition control.
	Air Flow Switch	Check air flow switch to be sure it closes when dryer is running. If not, adjust or replace switch.
	Hi-limit	Check for continuity. Should be 0 ohms resistance when cold. If not, replace thermostat.
Gas supply	No gas can cause system lockout	

# Dryer Trouble Shooting

Symptom	Probable Cause	Suggested Remedy
Tumbler turns, ignition sparks, no flame	Gas supply	Make sure gas supply is working.
	Gas pressure	Make manometer check of gas pressure. Adjust if necessary.
	Spark Electrode Sensor	Check for damage to electrode or mounting. Replace if necessary.
	Gas valve	Check coil continuity, replace valve if failed.
	Ignition Control	Check for 24VAC to gas valve coils. If no voltage replace ignition control.
Burner Lights, but goes on and off	Electrodes	Check low voltage harness for possible wire break or cuts to allow no signal back to ignition control
Slow drying	Temperature Setting	Check thermostat for correct high temperature setting. Adjust if necessary.
	Air flow restrictions necessary	<ol style="list-style-type: none"> <li>1. Check lint screen and clean if necessary.</li> <li>2. Check exhaust for correct length and clean if necessary.</li> <li>3. Check exhaust damper to insure that it opens when dryer is running and closes when dryer is not in use.</li> <li>4. Check makeup air to insure that it is adequate. Increase makeup air if necessary.</li> <li>5. Check static Back pressure no more than .3</li> </ol>
Manual overtemp Tripping Frequently	Recirculating chamber Lint Accumulation	Remove manual overtemp thermostat and inspect in chamber for excessive lint build up. Access also gained to this chamber by removing recirculation duct mounted at bottom of chamber, or the panel inside burner chamber between burners and rear back panel
	Exhaust ducting Excessive lint buildup	Remove exhaust duct at rear of dryer and inspect for excessive lint build up in complete duct from dryer to where duct exits building.
	Clean lint from top heat air chamber above tumbler	Remove front panel completely. Be careful of any wiring attached. Remove heated air chamber cover and clean above tumbler back to burner housing.

# Wiring Schematic for 60hz Dryer -10

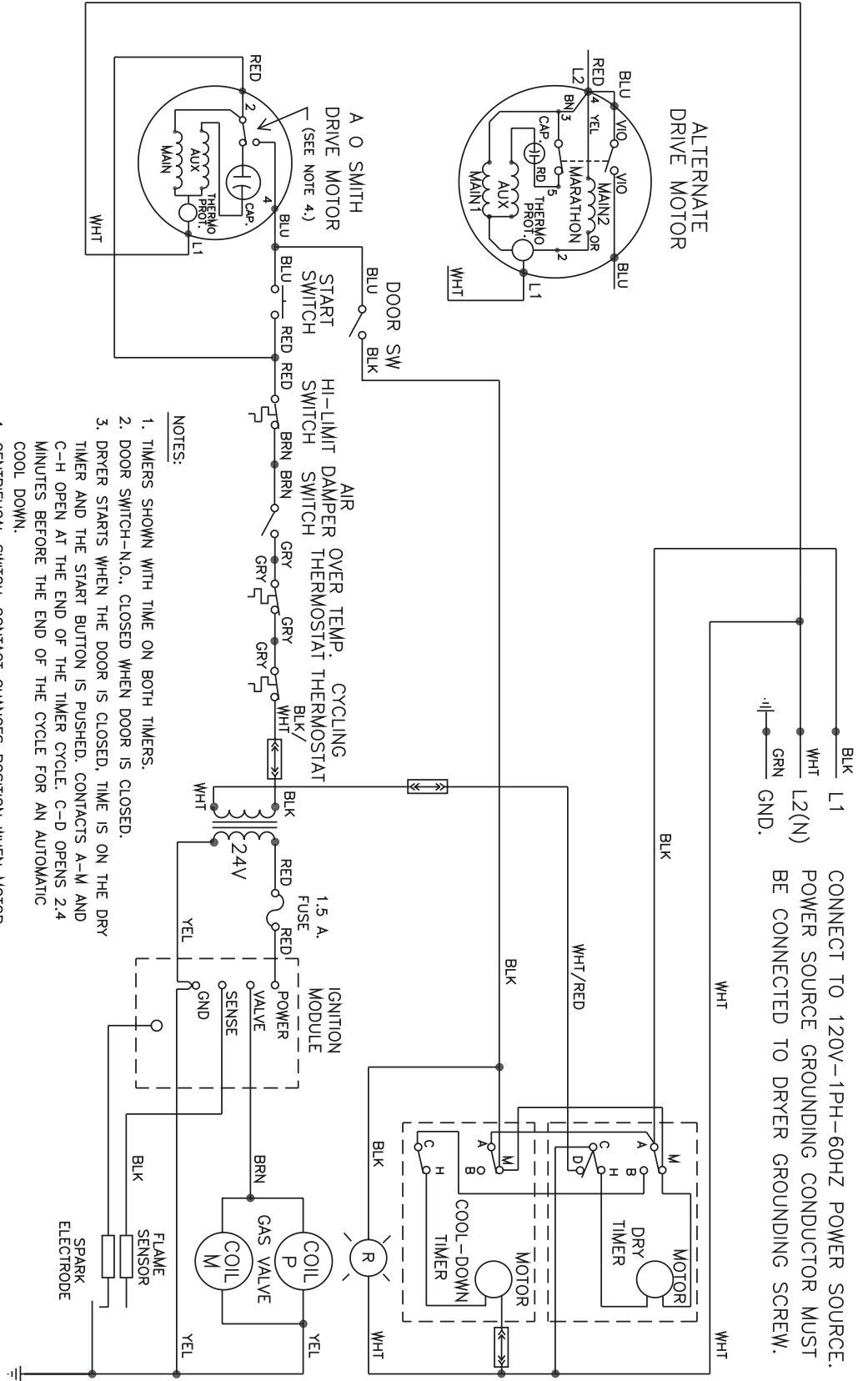

- NOTES:**
1. TIMERS SHOWN WITH TIME ON BOTH TIMERS.
  2. DOOR SWITCH-N.O., CLOSED WHEN DOOR IS CLOSED.
  3. DRYER STARTS WHEN THE DOOR IS CLOSED, TIME IS ON THE DRY TIMER AND THE START BUTTON IS PUSHED. CONTACTS A-M AND C-H OPEN AT THE END OF THE TIMER CYCLE. C-D OPENS 2.4 MINUTES BEFORE THE END OF THE CYCLE FOR AN AUTOMATIC COOL DOWN.
  4. CENTRIFUGAL SWITCH-CONTACT CHANGES POSITION WHEN MOTOR IS UP TO SPEED.
  5. REFER TO OWNER'S MANUAL FOR DESCRIPTION OF OPERATION AND REQUIREMENTS FOR HEATING CIRCUIT.

9345-900-001D

SCHEMATIC

DSTD30HT-10, DATD30HT-10, SCTD55HT-14  
 DSTC30HT-10, DATC30HT-10, SCTC55HT-14  
 DSTG30HT-10, DATG30HT-10, SCTG55HT-14







---

# **Section 5:**

## Dryer Parts Data

---

## Kits, Assemblies, & Common Parts

Description	Part Number
SWD Makeup Air Kit	9732-333-001
Cleanout Duct Assembly 8"	9973-034-001
Temperature Probe	9501-004-003
Controls 120VAC Black	9857-199-003
Controls 120VAC Blue	9857-199-001
Ignition Control Box	9807-109-001
Electrode Assembly, Ignition	9875-002-003
Thermostat, Hi-Limit	9576-203-002
Thermostat, Overtemp	9576-207-008
Fuseholder	9200-001-002
Fuse	8636-018-001
Relay	5192-288-002
Transformer, Ignition (120/24VAC)	8711-011-001
Lint Screen Assembly without Front	9805-029-002
Air Flow Switch	9539-461-009
Door Switch	9539-487-001
Tumbler Belt	9040-077-001
Motor Belt	9040-073-009
Tension Arm Complete	9861-022-001
Spider/Trunnion	9568-015-001
Door Handle	9244-082-001

# Dryer Cabinet Group Before Serial #232998

	Description	Part Number	Qty
1	Loading Door Complete SS/Brushed SS/Gray	9960-256-030	1
1	Loading Door Complete SS/Chrome/Blk	9960-256-037	1
2	Door Assy, Loading (Ring only) Brushed SS	9960-255-008	1
2	Door Assy, Loading (Ring only) Chrome	9960-255-016	1
3	Plate Assy, Hinge (SS)	9982-280-011	1
4	Screw Hinge to Door	9545-012-015	4
*	Nut, Hinge to Door	8640-413-002	4
5	Glass, Door	9212-002-003	1
6	Gasket, Door Glass (Gray)	9206-164-009	1
6	Gasket, Door Glass (Black)	9206-413-001	1
*	Support Door Glass	9548-117-000	1
7	Gasket, Door Outer Rim (Gray)	9206-420-002	1
7	Gasket, Door Outer Rim (Black)	9206-420-003	1
8	Handle, Loading Door	9244-082-001	1
*	Screw, Handle	9545-018-017	2
*	Stud Door Catch	9531-033-001	1
*	Nut-Hex, #10-32	8640-413-001	1
*	Nut, Acorn	8640-413-003	1
*	Catch, Loading Door	9086-015-002	1
9	Strap, Hinge (Gray)	9544-047-007	1
9	Strap, Hinge (Black)	9544-047-011	1
10	Screw, Hinge to Door	9545-052-001	1
11	Washer-Fiber/Plastic	8641-436-003	1
12	Front Panel Assy	9989-468-001	1
*	Insulation-Front Panel, Top Half	9277-053-001	1
*	Insulation-Front Panel, Bottom Half	9277-053-002	1
13	Nameplate - Dexter Washer/Dryer	9412-102-001	1
14	Overlay on Escutcheon OPL W/D	9435-010-001	1
14	Escutcheon-Dryer OPL	9141-155-001	1
*	Screw-TRHD Torx, 6BSDx1/2,BLK	9545-031-009	10
15	Plate Controls OPL Lefthand side	9452-686-001	1
*	Screw 8-32x5/16	9545-010-010	4
16	Timer Dry	9571-350-002	1
17	Timer Cooldown	9571-350-002	1
18	Knob Black Control	9307-176-001	2
19	Plate Control OPL Righthand side	9452-687-001	1
*	Screw, 6BSDx1/2 Blk	9545-031-009	4
20	Decal Temp Start OPL W/D	8527-117-001	1
21	Knob Temp Control	9307-176-001	1
22	Thermostat	9576-209-003	1
*	Screw 6-32x5/16	9545-044-006	2
*	Bushing for wire	9053-067-002	1
23	Start Push Type	9539-460-001	1
*	Cabinet Touch Up Paint (White)	9472-001-013	1



15

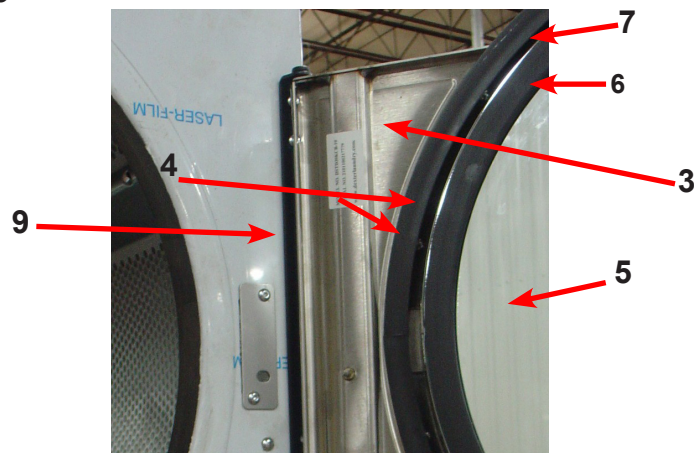
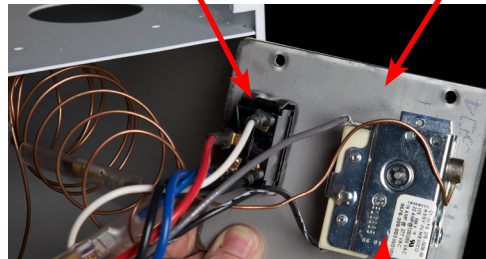
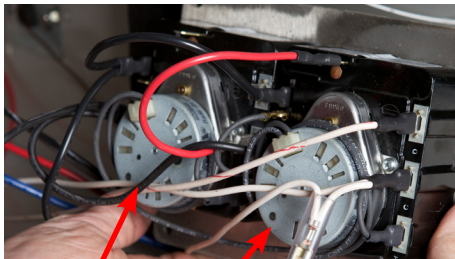

# Dryer Cabinet Group After Serial #232998

	Description	Part Number	Qty
1	Loading Door Complete SS/Brushed SS/Gray	9960-256-030	1
1	Loading Door Complete SS/Chrome/Blk	9960-256-035	1
2	Door Assy, Loading (Ring only) Brushed SS	9960-255-008	1
2	Door Assy, Loading (Ring only) Chrome	9960-255-016	1
3	Plate Assy, Hinge (SS)	9982-280-011	1
4	Screw Hinge to Door	9545-012-015	4
*	Nut, Hinge to Door	8640-413-002	4
5	Glass, Door	9212-002-003	1
6	Gasket, Door Glass (Gray)	9206-164-009	1
6	Gasket, Door Glass (Black)	9206-413-001	1
*	Support Door Glass	9548-117-000	1
7	Gasket, Door Outer Rim (Gray)	9206-420-002	1
7	Gasket, Door Outer Rim (Black)	9206-420-003	1
8	Handle, Loading Door	9244-082-001	1
*	Screw, Handle	9545-018-017	2
*	Stud Door Catch	9531-033-001	1
*	Nut-Hex, #10-32	8640-413-001	1
*	Nut, Acorn	8640-413-003	1
*	Catch, Loading Door	9086-015-002	1
9	Strap, Hinge (Gray)	9544-047-007	1
9	Strap, Hinge (Black)	9544-047-011	1
10	Screw, Hinge to Door	9545-052-001	1
11	Washer-Fiber/Plastic	8641-436-003	1
12	Front Panel Assy	9989-468-001	1
*	Insulation-Front Panel, Top Half	9277-053-001	1
*	Insulation-Front Panel, Bottom Half	9277-053-002	1
13	Nameplate - Dexter Washer/Dryer Black	9412-202-001	1
14	Overlay on Escutcheon OPL W/D Black	9435-036-001	1
14	Escutcheon-Dryer OPL	9141-155-001	1
*	Screw-TRHD Torx, 6BSDx1/2,BLK	9545-031-009	10
15	Plate Controls OPL Lefthand side	9452-686-001	1
15	Decal Manual Timer OPL W/D Black	8527-153-001	1
*	Screw 8-32x5/16	9545-010-010	4
16	Timer Dry	9571-350-002	1
17	Timer Cooldown	9571-350-002	1
18	Knob Black Control	9307-176-001	2
19	Plate Control OPL Righthand side	9452-687-001	1
*	Screw, 6BSDx1/2 Blk	9545-031-009	4
20	Decal Temp Start OPL W/D Black	8527-154-001	1
21	Knob Temp Control	9307-176-001	1
22	Thermostat	9576-209-003	1
*	Screw 6-32x5/16	9545-044-006	2
*	Bushing for wire	9053-067-002	1
23	Start Push Type	9539-460-001	1
24	Cover-Hinge, Black	9074-341-002	1
25	Screws-TRHDCR, 10B x 3/8, Black	8636-018-001	2

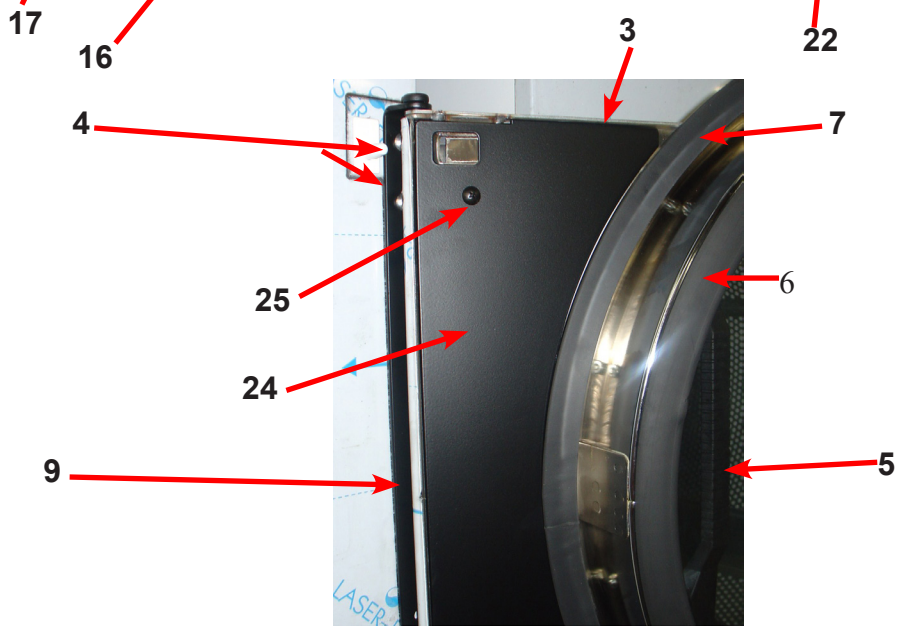
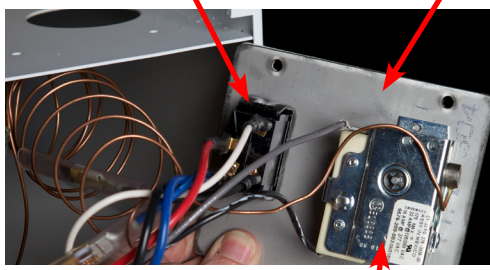
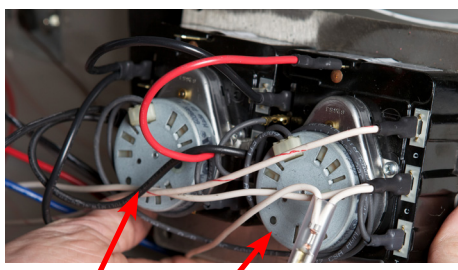

# Dryer Cabinet Group Continued

Key	Description	Part Number	Qty
1	Nameplate - Dexter Washer/Dryer	9412-133-001	1
2	Lint Drawer Assy Complete W/Front	9866-004-010	1
*	Lint Screen Assy w/o Front	9805-029-002	1
*	Lint Drawer Front (Aluminum)	9974-010-001	1
3	Overlay, Lint Drawer	9435-003-011	1
*	Screen (Course)	9555-057-002	1
*	Screen (Fine Mesh)	9555-057-003	1
*	Felt-Seal (back of lint screen)	9532-074-003	1
*	Screw-Lint screen strap hold down	9545-008-001	14
4	Thumbturn locking assembly for Lint Screen	8650-026-002	1
5	Door Switch	9539-461-001	1
*	Cabinet Cover	9074-261-001	1
*	Insulation, Cabinet Cover	9277-041-011	1



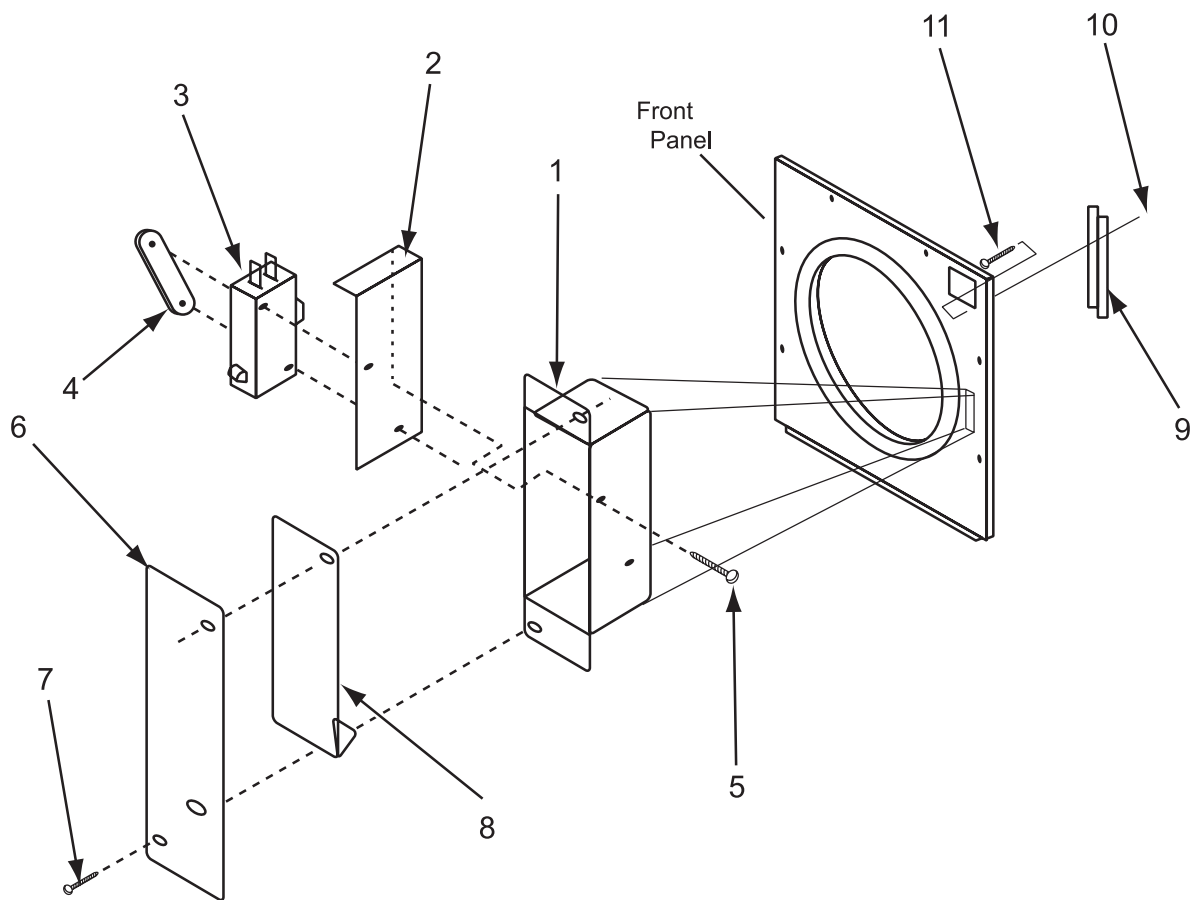

Key	Description	Part Number	Qty
1	Box-Door Switch	9041-076-002	1
2	Shield-Door Switch	9550-159-001	1
3	Door Switch	9539-461-001	1
4	Twin Nut Special	8640-401-001	1
5	Screw- 4-40x5/8	9545-020-001	2
6	Cover-Switch Box	9074-255-001	1
7	Screw-TRHDTORX, 10ABx3/4	9545-008-020	2
8	Acuator-Door Switch	9008-004-002	1
9	Conduit - Special	6068-043-001	1
10	Screw, 10-32x1/2	9545-012-003	2
11	Nut, Elatic Stop 10-32	8640-413-004	2
*	Gromet, 1/4	9029-037-001	1
*	Wire-BLK, 45"	8220-001-221	1
*	Wire-BLU, 45"	8220-001-222	1

# Dryer Cabinet Group Continued After Serial #232998

Key	Description	Part Number	Qty
1	Nameplate - Dexter Washer/Dryer	9412-202-001	1
2	Lint Drawer Assy Complete W/Front	9866-004-013	1
*	Lint Screen Assy w/o Front	9805-029-002	1
*	Lint Drawer Front (Aluminum)	9974-010-001	1
3	Overlay, Lint Drawer	9435-029-002	1
*	Screen (Course)	9555-057-002	1
*	Screen (Fine Mesh)	9555-057-003	1
*	Felt-Seal (back of lint screen)	9532-074-003	1
*	Screw-Lint screen strap hold down	9545-008-001	14
4	Thumbturn locking assembly for Lint Screen	8650-026-002	1
5	Overlay on Escutcheon OPL W/D Black	9435-036-001	1
6	Door Switch	9539-487-001	1

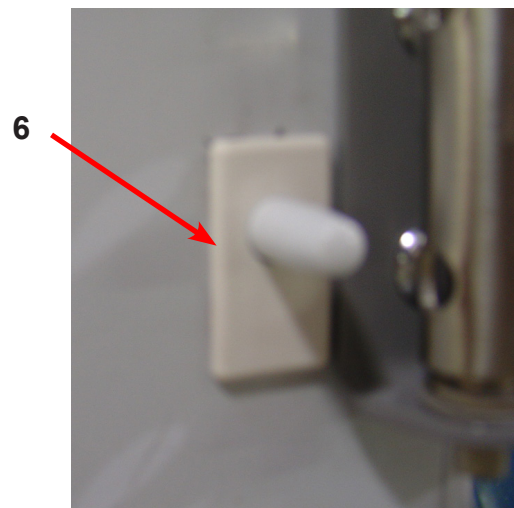

# Dryer Burner Housing Group Before Serial #232998

Key	Description	Part Number	Qty
*	Housing Assembly, Burner	9803-199-001	1
1	Panel-Burner Housing Front & Back	9454-831-001	1
*	Panel-Burner Housing, Side Left	9454-789-001	1
2	Panel-Burner Housing, Side Right	9454-790-001	1
*	Baffle-Burner Housing	9049-080-001	1
*	Connector Assembly- Burner	9828-015-001	1
3	Panel-Burner Housing, Top	9454-791-001	1
4	Cover Burner Housing, Top	9074-307-001	1
*	Screw, 10Bx1/4	9545-008-001	4
*	Screw, 10ABx3/8	9545-008-006	23
*	Plate, Recirculation Cover	9452-729-001	1
*	Screw, 10Bx1/4	9545-008-001	6
*	Shield, Burner Inlet	9550-173-001	1
*	Screw, 10ABx3/8	9545-008-024	3
5	Burner, Main	9048-020-001	2
*	Panel- Burner Housing, Back	9454-816-001	1
*	Screw, 10Bx1/4	9545-008-001	4
6	Electrode-Ignition	9875-002-003	1
*	Screw, 8Bx1/4	9545-045-001	2
7	Thermostat-HI-Limit	9576-203-002	1
*	Bracket-Hi-Limit	9029-192-001	1
*	Spacer-Hi-Limit	9538-142-001	2
*	Screw, 8Bx3/4	9545-045-007	2
*	Wire Assy-BRN, 31"	8220-001-415	1
*	Wire Assy-RED, 31"	8220-095-025	1
*	Thermostat-Over Temp, Manual Reset	9576-207-008	1
*	Screw, 10ABx3/8	9545-008-006	2
*	Bushing, Anti-short,conduit	2114-008-000	2
8	Cover Assembly, OverTemp Thermostat	9825-057-002	1
*	Screw, 10ABx3/8	9545-008-006	2
9	Control Assy,Gas Valve	9857-134-001	1
10	Manifold Assy	9381-009-001	1
*	Orfice-Natural, #32	9425-069-009	2
*	Orfice-LP, #50	9425-069-008	2
11	Bracket-Manifold, Gas	9029-047-001	1
12	Bracket-Control	9039-915-001	1
12	Bracket-Support, Gas Valve	9029-116-001	1
*	Elbow- 1/2x90, Black Iron	8615-104-037	1
*	Nipple- 1/2x2, Black Iron	8655-073-040	3
*	Nipple- 15xClose, Back Iron	8655-073-041	1
*	Union- 1/2, Black Iron	8615-104-035	1
*	Valve-Gas Shutoff, (Optional)	9379-196-001	1
13	Duct Assy, Recirculation	9973-033-001	1

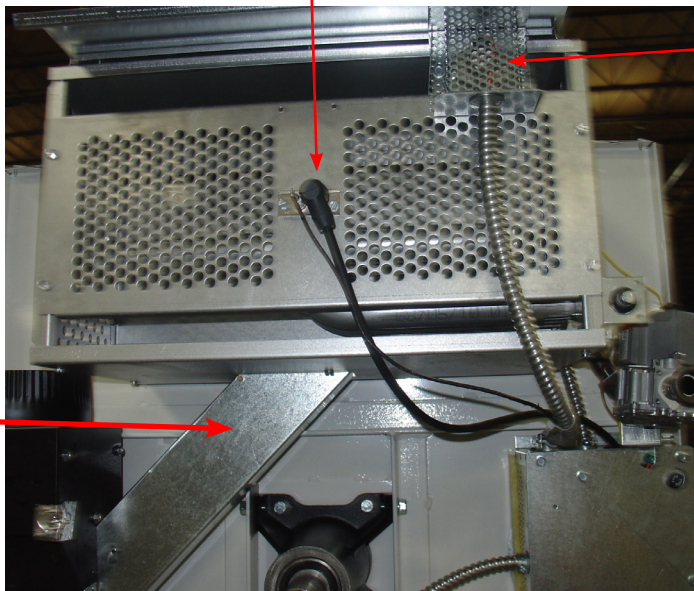
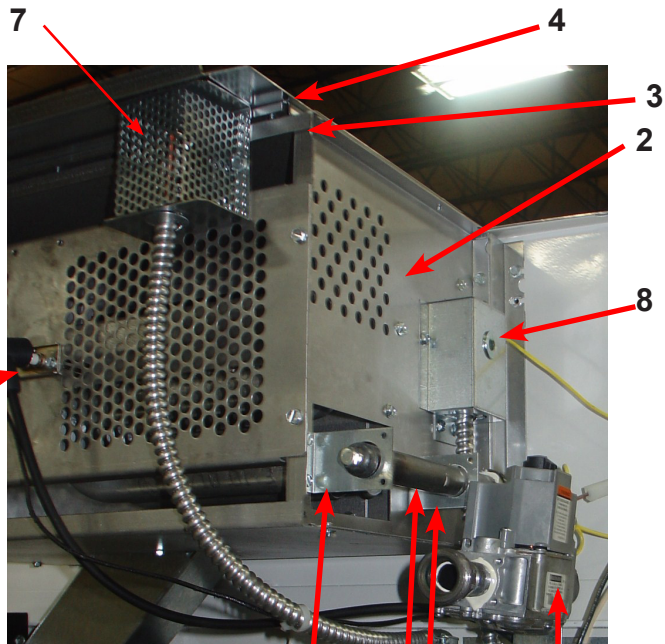
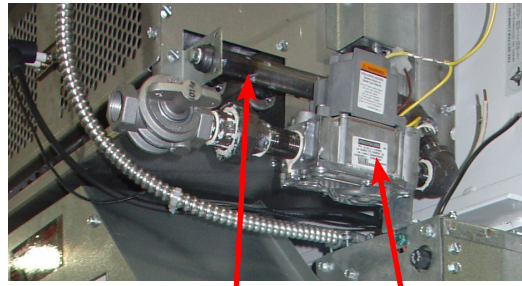
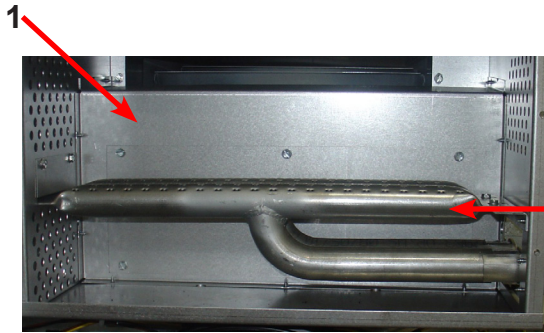

# Dryer Burner Housing Group After Serial #232998

Key	Description	Part Number	Qty
*	Housing Assembly, Burner	9803-199-001	1
1	Panel-Burner Housing Front & Back	9454-831-001	1
*	Panel-Burner Housing, Side Left	9454-789-001	1
2	Panel-Burner Housing, Side Right	9454-790-001	1
*	Baffle-Burner Housing	9049-080-001	1
*	Connector Assembly- Burner	9828-015-001	1
3	Panel-Burner Housing, Top	9454-791-001	1
4	Cover Burner Housing, Top	9074-307-001	1
*	Screw, 10Bx1/4	9545-008-001	4
*	Screw, 10ABx3/8	9545-008-006	23
*	Plate, Recirculation Cover	9452-729-001	1
*	Screw, 10Bx1/4	9545-008-001	6
*	Shield, Burner Inlet	9550-173-001	1
*	Screw, 10ABx3/8	9545-008-024	3
5	Burner, Main	9048-020-001	2
*	Panel- Burner Housing, Back	9454-816-001	1
*	Screw, 10Bx1/4	9545-008-001	4
6	Electrode-Ignition	9875-002-003	1
*	Screw, 8Bx1/4	9545-045-001	2
7	Thermostat-HI-Limit	9576-203-002	1
*	Bracket-Hi-Limit	9029-192-001	1
*	Spacer-Hi-Limit	9538-142-001	2
*	Screw, 8Bx3/4	9545-045-007	2
*	Wire Assy-BRN, 31"	8220-001-415	1
*	Wire Assy-ORG, 31"	8220-095-018	1
*	Thermostat-Over Temp, Manual Reset	9576-207-008	1
*	Screw, 10ABx3/8	9545-008-006	2
*	Bushing, Over Temp	2114-008-000	2
8	Cover Assembly, OverTemp Thermostat	9825-057-002	1
*	Screw, 10ABx3/8	9545-008-006	2
9	Control Assy,Gas Valve	9857-134-001	1
10	Manifold Assy	9381-012-001	1
*	Orfice-Natural, #32	9425-069-009	2
*	Orfice-LP, #50	9425-069-008	2
11	Bracket-Manifold, Gas	9029-257-001	1
12	Bracket-Manifold, Gas	9029-258-001	1
*	Screws,	9545-008-006	4
13	Duct Assy, Recirculation	9973-033-001	1
13	Valve-Gas Shutoff, (Optional)	9379-196-001	1
14	Plug, Manifold		1

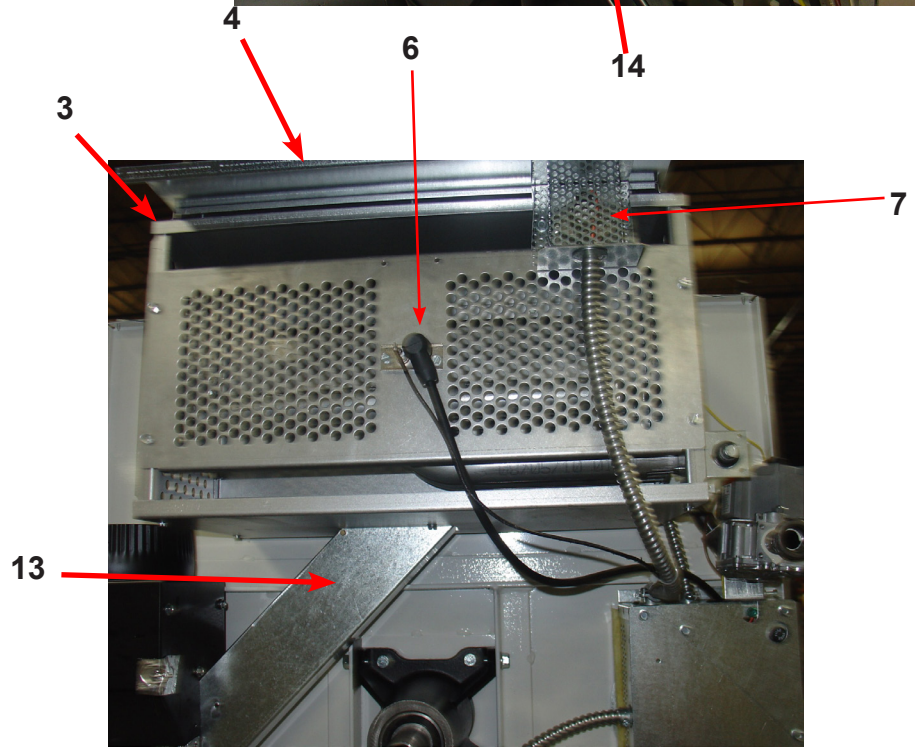
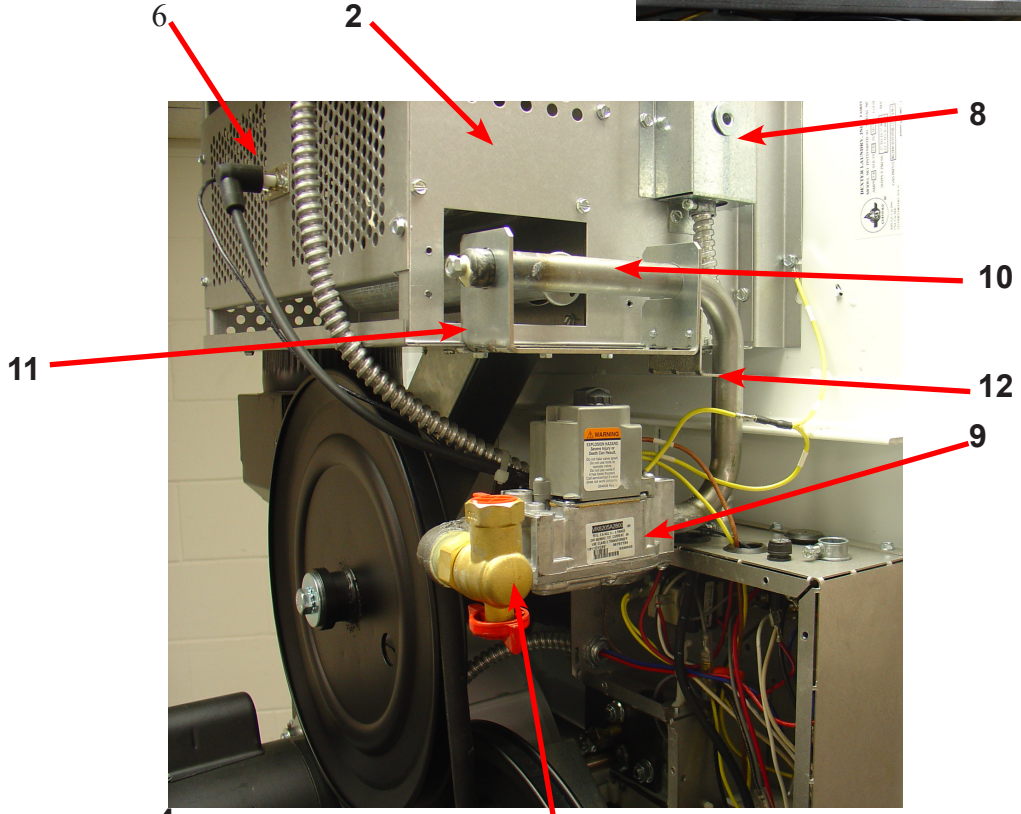
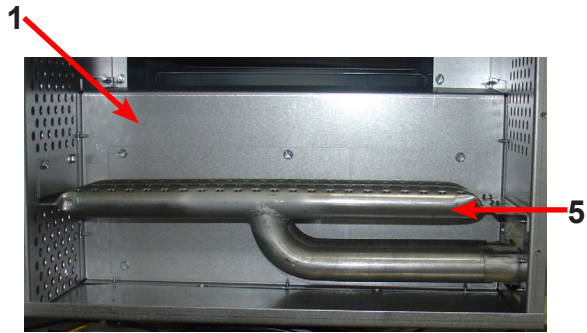

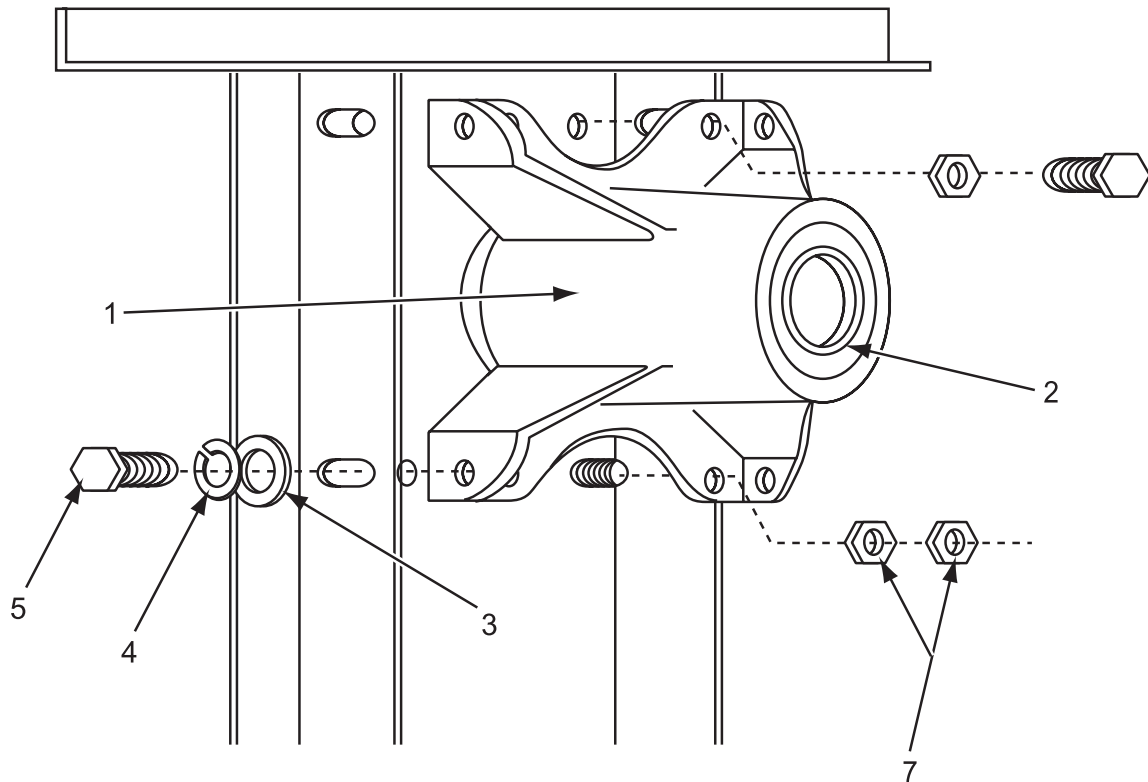

## Bearing Housing Assembly

Key	Description	Part Number	Qty
1	Housing, Bearing	9241-161-002	1
2	Bearing, Ball (Front & Rear)	9036-130-001	2
3	Washer, Flat 3/8	8641-581-009	4
4	Lock Washer Spring, 3/8	8641-582-003	4
5	Screw, 3/8-24x3/4	9545-049-002	4
6	Nut, 3/8-24	8640-415-002	2
7	Screw, 3/8-24x1	9545-049-001	2
8	Nut, 5/16-24	8640-400-002	4
*	Spacer, Bearing	9538-139-002	1
*	Shim, Tumbler	9552-013-003	4
*	Bearing Housing Complete Assy (Includes bearings & Spacer)	9803-160-003	1

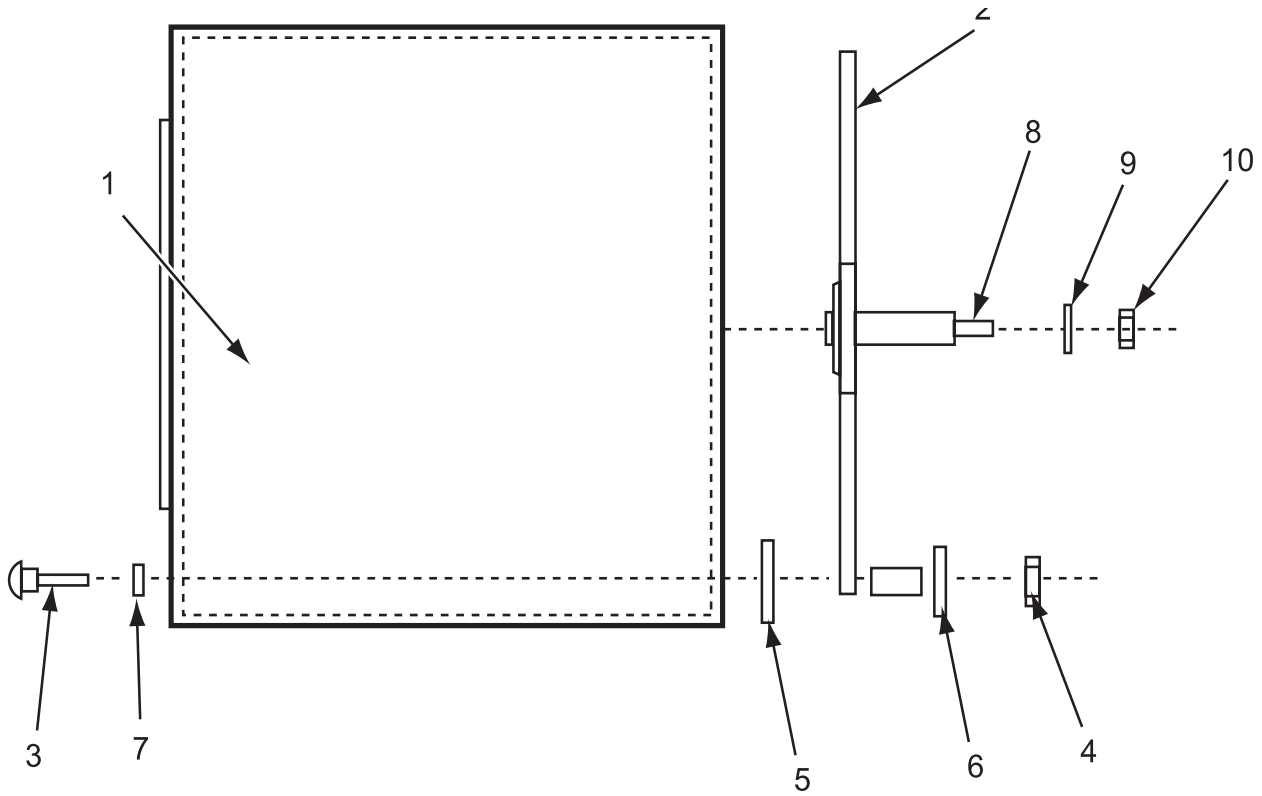

## Spyder Trunion & Cylinder

Key	Description	Part Number	Qty
*	Tumbler Assy Complete W/Spider (GALV)	9848-127-001	1
1	Tumbler Assy (Galvanized)	9848-146-001	1
1	Tumbler Assy Complete W/Spider (SS)	9848-127-002	1
1	Tumbler Assy (Stainless)	9848-146-002	1
2	Spider Assy	9568-011-001	1
3	Rod, Tumbler	9497-019-003	3
4	Nut, Wiz Lock	8640-415-004	3
6	Shim	9552-013-000	AR
7	Washer, Special	8641-554-001	3
8	Key- Woodruff	9306-006-000	1
9	LockWasher - IntTooth, 1"	8641-582-015	1
10	Washer -Flat	8641-581-035	1
11	Nut-Hex, 1" -14	8640-222-000	1

# Dryer Rear View-Bearing Housing 30Lb

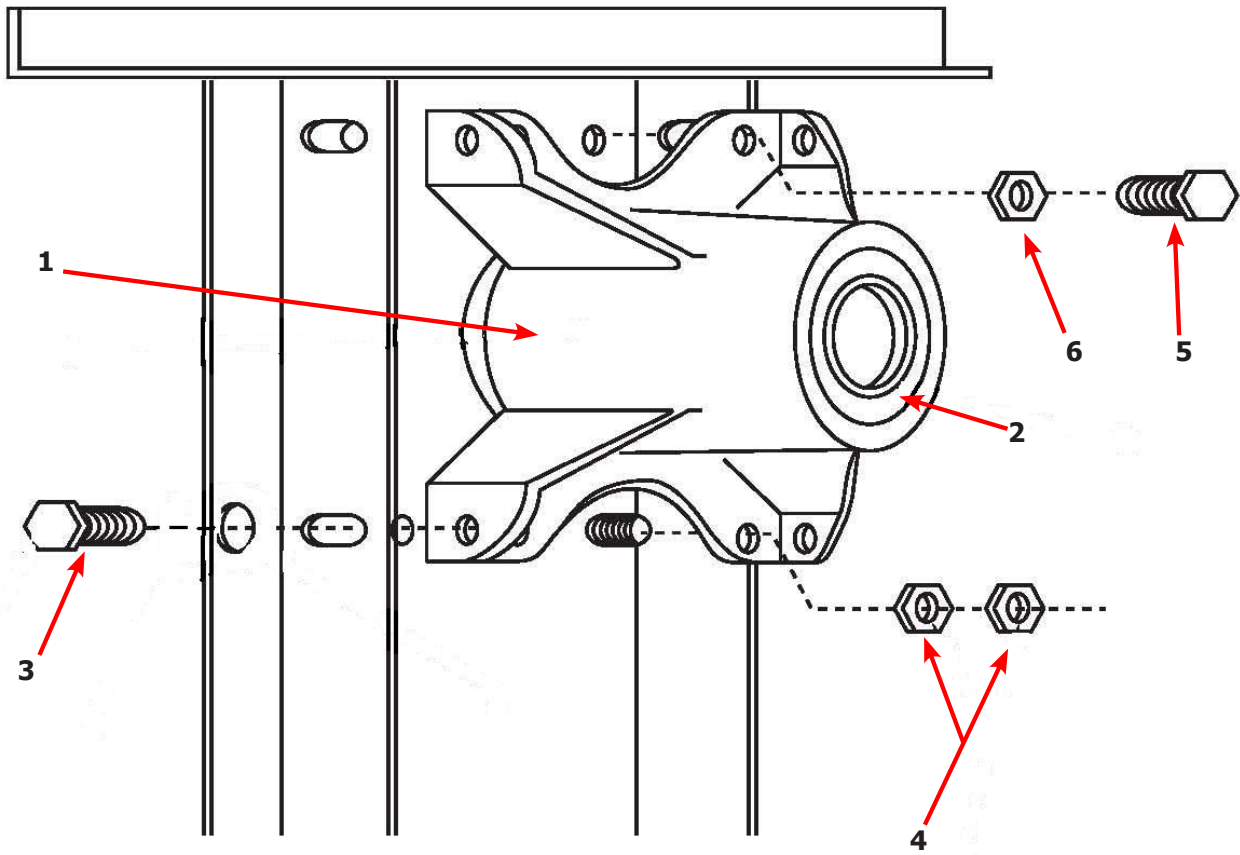

Key	Description	T-30	QTY
*	Bearing Housing Complete Assy (Includes bearings & Spacer)	9803-160-003	1
1	Housing, Bearing	9241-161-002	1
*	Bearing, Ball, Front	9036-130-001	1
*	Spacer, Bearing	9538-139-002	1
2	Bearing, Ball, Rear	9036-130-001	1
3	Screw-Wizlock, 3/8-24x3/4	9545-049-002	4
4	Nut, 5/16-18	8640-400-002	4
5	Screw, 3/8-24x1	9545-049-001	2
6	Nut, 3/8-24	8640-415-002	2
*	Shim, Tumbler	9538-139-002	AR

# Dryer Tumbler Group 30Lb

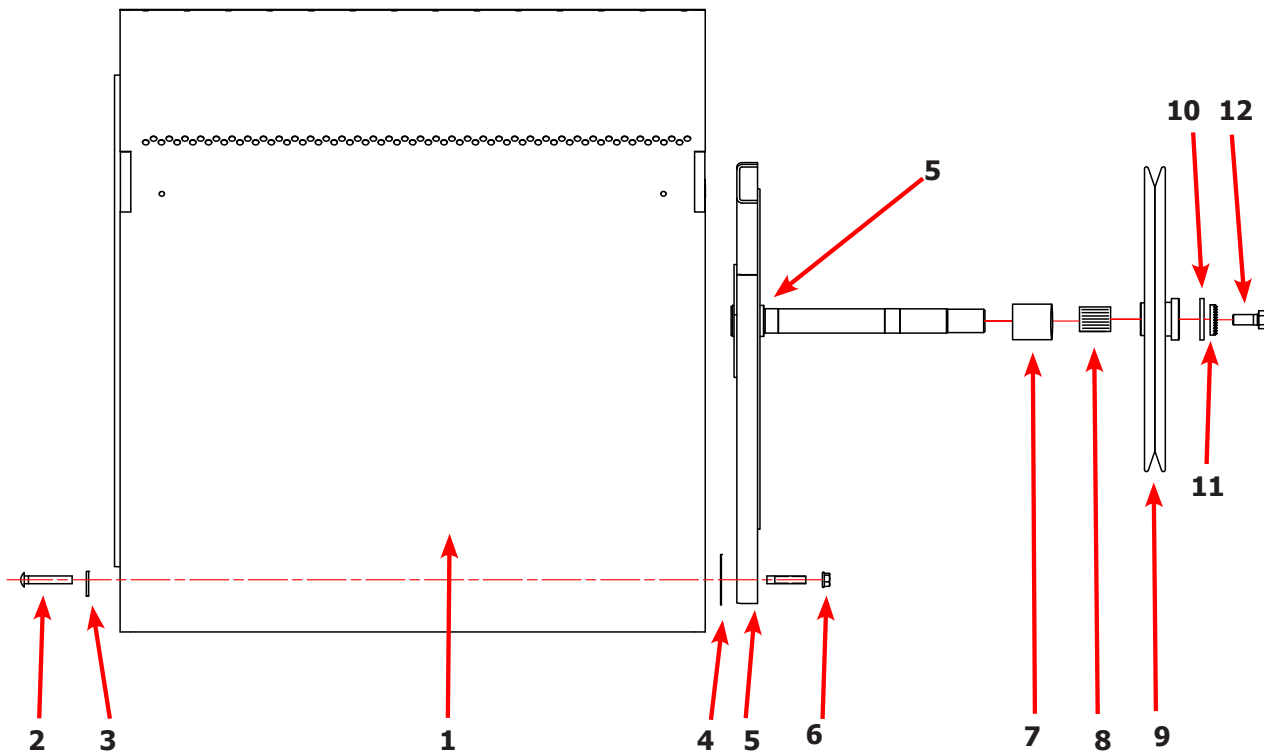

Key	Description	T-30	QTY
*	Tumbler Assy Complete W/Spider (GALV)	9848-142-001	1
1	Tumbler Assy (Galvanized)	9848-142-001	1
1	Tumbler Assy Complete W/Spider (SS & Galv front)	9848-147-002	1
1	Tumbler Assy (Stainless Galvanized front)	9848-147-002	1
2	Rod, Tumbler	9497-019-003	4
3	Washer, Special	8641-554-001	4
4	Shim	9552-013-003	AR
5	Spider Assy	9568-015-001	1
6	Nut, Wiz Lock	8640-415-004	3
7	Spacer-Shaft	9538-164-001	1
8	Tolerance Ring	9487-234-005	1
9	Pulley, Driven	9908-049-002	1
10	Washer -Flat	8641-581-026	1
11	LockWasher - IntTooth, 1"	8641-582-016	1
12	Screw, 1/2-13x1 1/4	9545-017-009	1

# Dryer Rear View

Key	Description	Part Number	Qty
1	Motor, Drive	9376-309-001	1
2	Plate, Motor Mounting	9452-766-001	1
*	Screw-Hex, 3/8-16x3/4	9545-029-008	4
*	Screw, Motor to Plate to Housing Back	9545-018-019	5
*	Lock Washer	8641-582-007	5
*	Spacer	9538-163-006	5
*	Flat Washer	8641-581-017	15
*	Rubber Grommet	9209-086-002	5
*	Grommet Spacers, Metal	9538-166-006	5
*	Pulley, Motor	9453-157-001	1
*	Screw, Set Motor Pulley	9545-028-013	2
3	Back Assy, Blower Housing	9962-015-002	1
*	Impeller, W/Set Screws	9278-039-001	2
4	Belt, Drive Motor	9040-073-009	1
5	Belt, Driven-Tumbler	9040-077-001	1
6	Pulley, Driven	9908-040-001	1
*	Key- Woodruff	9306-006-000	1

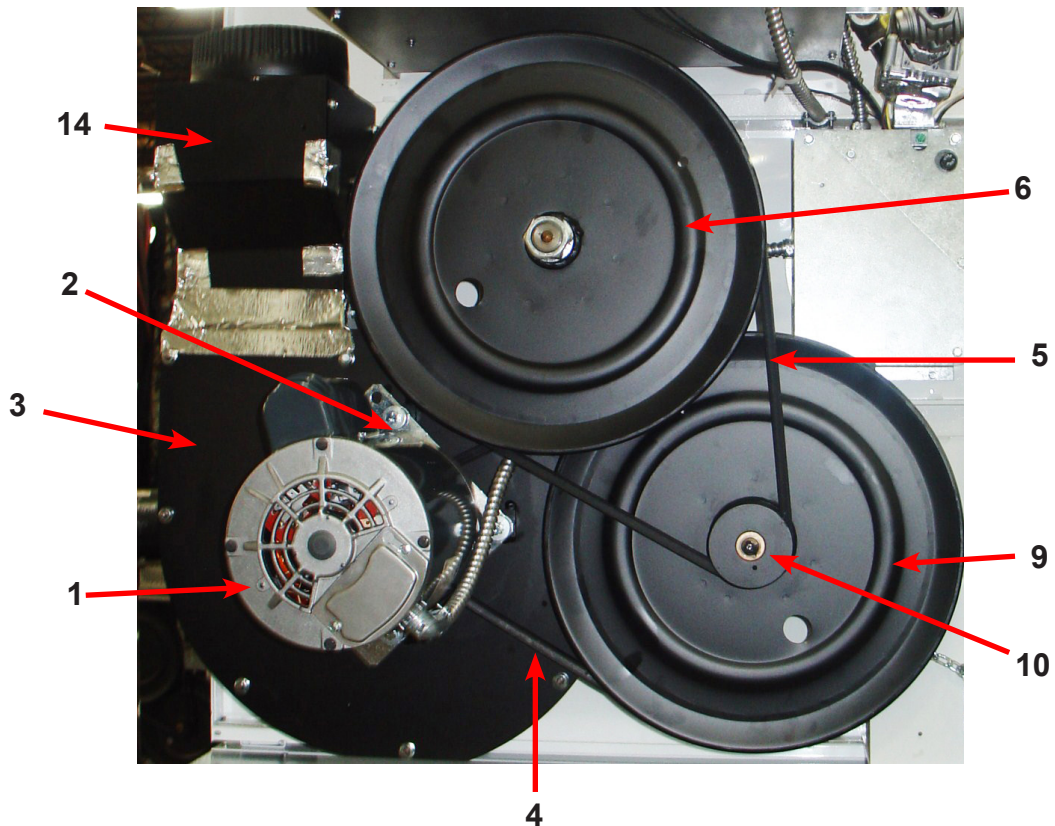

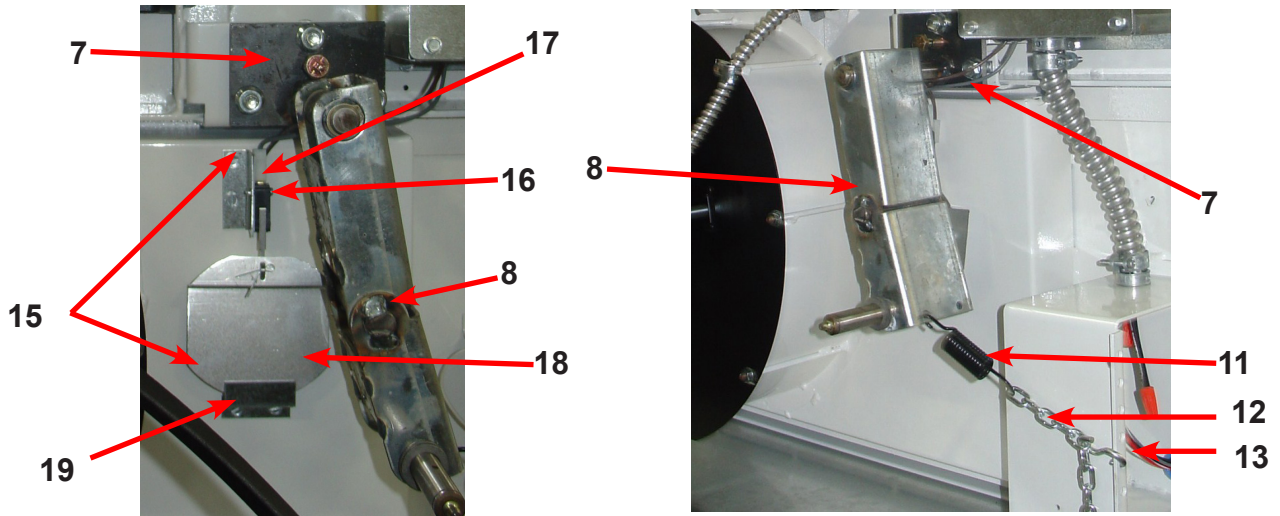

Key	Description	Part Number	Qty
7	Support Assy, Intermediate Pulley	9991-053-001	1
*	Bolt, Rd Hd 3/8-16x1 1/4	9545-029-010	3
*	Bolt 3/8-16x 1 1/2	9545-029-003	1
*	Nut	8640-415-004	3
*	Washer Flat	8641-581-035	4
8	Arm Assy-Tension, Complete	9861-022-001	1
*	Washer Flat	8641-581-035	3
*	Ring-Retaining	9487-200-003	1
9	Pulley Assy, Intermediate	9908-039-004	1
10	Bushing, Bronze	9036-145-002	2
*	Spacer, Shaft	9538-164-001	1
*	LockWasher - IntTooth, 1"	8641-582-015	1
*	Washer -Flat	8641-581-035	1
*	Nut-Hex, 1" -14	8640-222-000	1
11	Spring, Tension	9534-319-002	1
12	Chain, Tension	9099-012-002	1
13	Hook, Tension	9248-022-002	1
14	Housing-Assy, Damper	9803-184-002	1
*	Damper	9125-003-001	2
*	Pin, Hinge Damper	9451-146-004	2
*	Nut, Spring	8520-141-000	4
15	Switch Assembly, Air Flow	9801-060-001	1
16	Switch, Air Flow	9539-461-009	1
17	Bracket, Switch-Air Flow	9029-044-001	1
18	Acuator, Switch	9008-007-001	1
*	Pin, Cotter	9451-169-002	1
*	Screw	9545-020-001	1
*	Nut, Special Twin	8640-401-001	1
*	Shield, Switch	9550-169-003	1
19	Bracket, Actuator Stop	9029-046-001	1
*	Screw	9545-008-024	4

# Dryer Back Panels and Guards

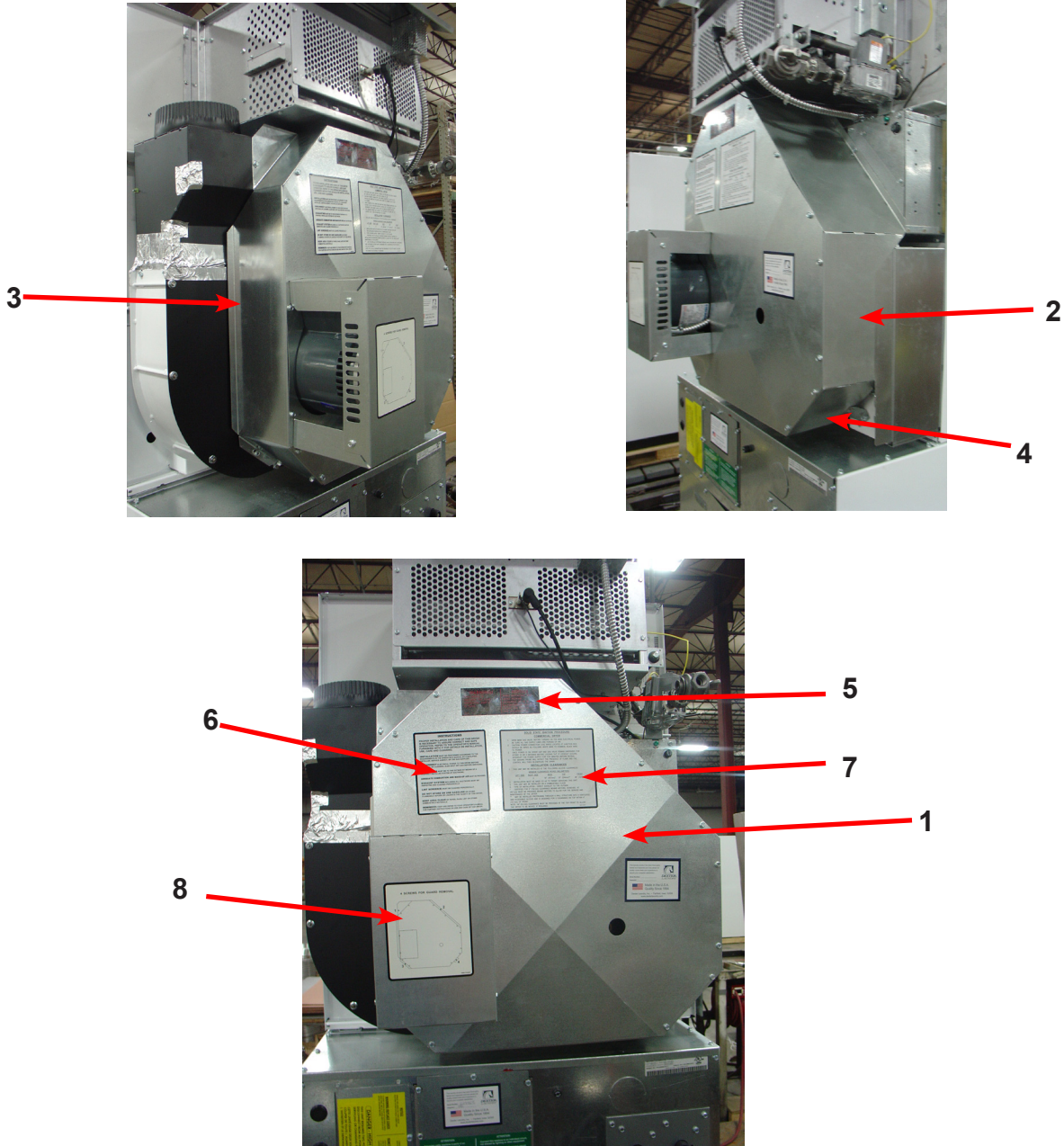

Key	Description	Part Number	Qty
1	Guard, Drive	9208-064-001	1
2	Pannel, Drive Guard, LH Before Serial #232998	9454-649-001	1
	Pannel, Drive Guard, LH After Serial #232998		
3	Pannel, Drive Guard, RH	9989-481-001	1
4	Panel, Drive Guard Bottom	9454-739-001	1
*	Screw, Guards	9545-008-024	8
5	Warning, Lable	8502-600-001	1
6	Lable, Instructions	8502-645-001	1
7	Lighting and Clearence, Lable	8527-112-001	1
8	Lable, Guard Removal	8502-710-001	1



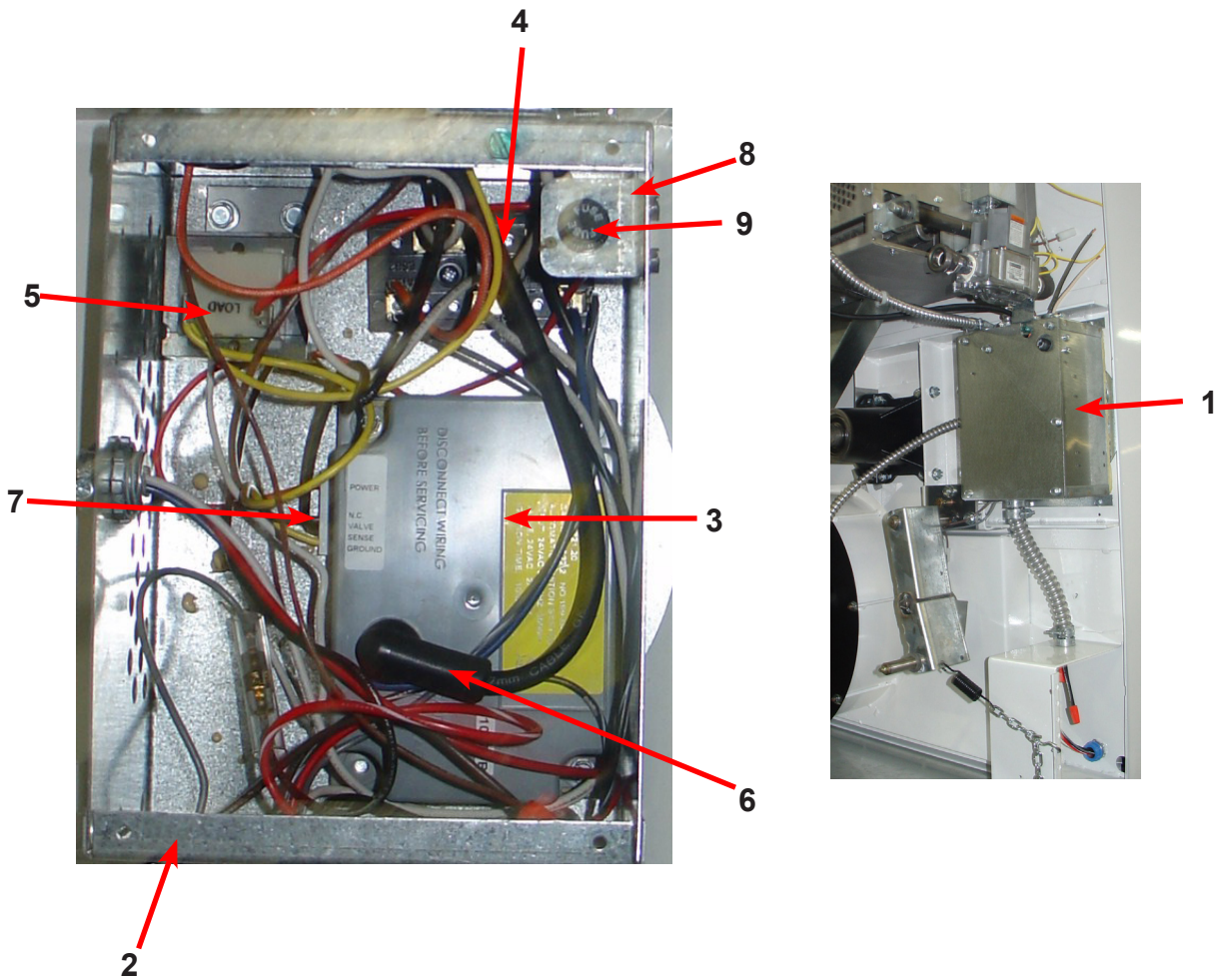

## Electrical Box / Ignition Control Before Serial # 232998

Key	Description	Part Number	Qty
1	Electical Box Assy, Complete (2-9 included)	9857-128-001	1
2	Box Assy. (Box Only)	9807-079-001	1
3	Control, Ignition (Grey Box)	9857-116-003	1
4	Terminal Block-Power	9897-026-001	1
5	Transformer 120/24VAC	8711-011-001	1
6	Wire Assy- Hi Voltage	9631-403-002	1
7	Harness- Low Voltage	9627-678-001	1
*	Wire Assy-Red, 9"	8220-001-225	1
8	Bracket Fuse Holder	9029-048-001	1
9	Fuse Holder	9200-001-002	1
*	Fuse, 1.5 Amp	8636-018-001	1
*	Insulation, Electrical Box (back)	9277-041-013	1

# Wiring Informative for 60hz Dryer -10

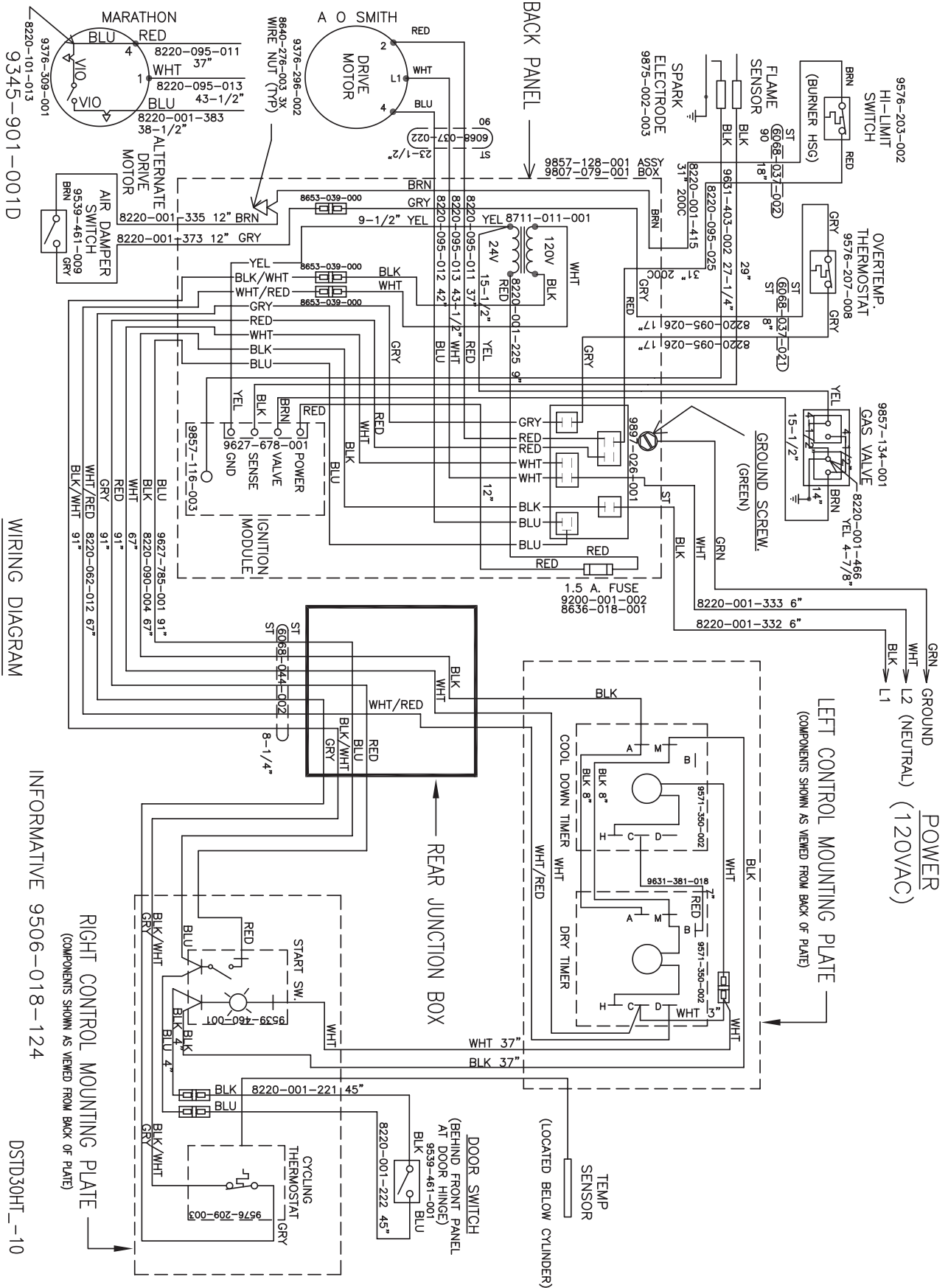

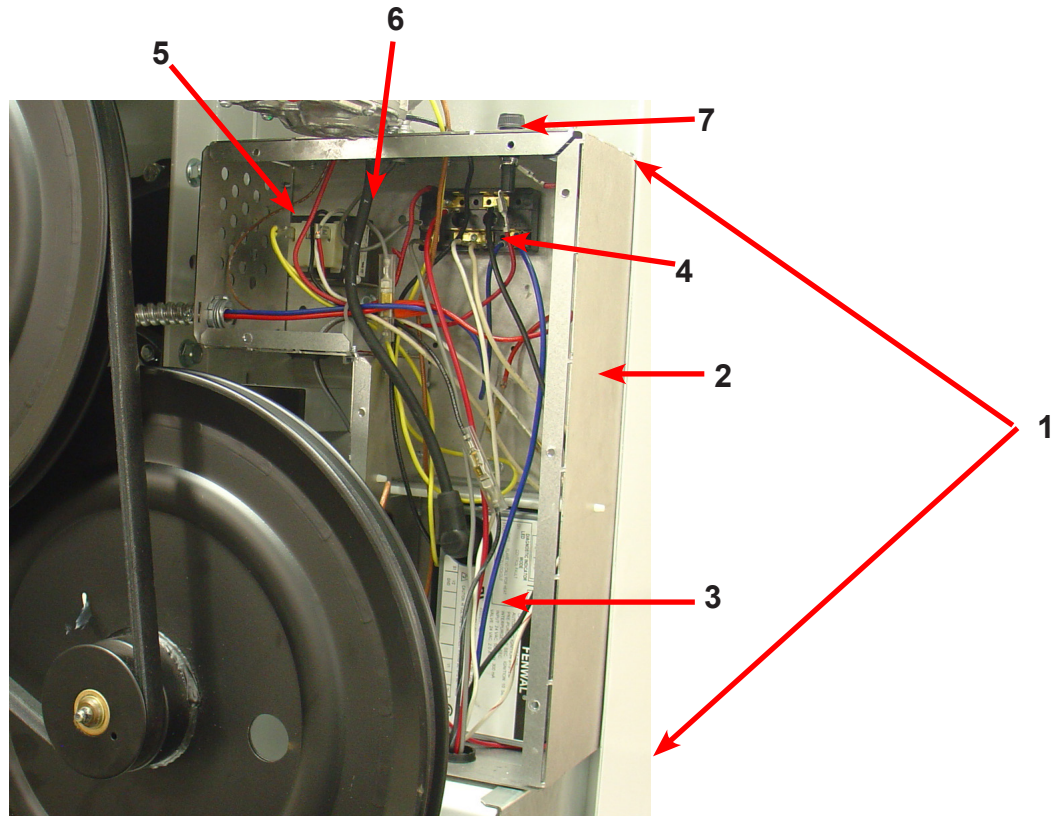

## Electrical Box / Ignition Control After S/N 232998

Key	Description	Part Number	Qty
1	Electrical Box Assy, Complete (2-9 included)	9857-128-021	1
2	Box Assy, (Box Only)	9807-100-001	1
3	Control, Ignition (Grey Box)	9857-182-001	1
4	Terminal Block-Power	9897-026-003	1
5	Transformer 120/24VAC	8711-011-001	1
*	Wire Assy-Red, 9"	8220-001-225	1
6	Wire Assy- Hi Voltage	9631-403-009	1
7	Fuse Holder	9200-001-002	1
*	Fuse, 1.5 Amp	8636-018-001	1
*	Insulation, Electrical Box (back)	9277-041-013	1

# Electrical Box / Ignition Control After S/N 232998

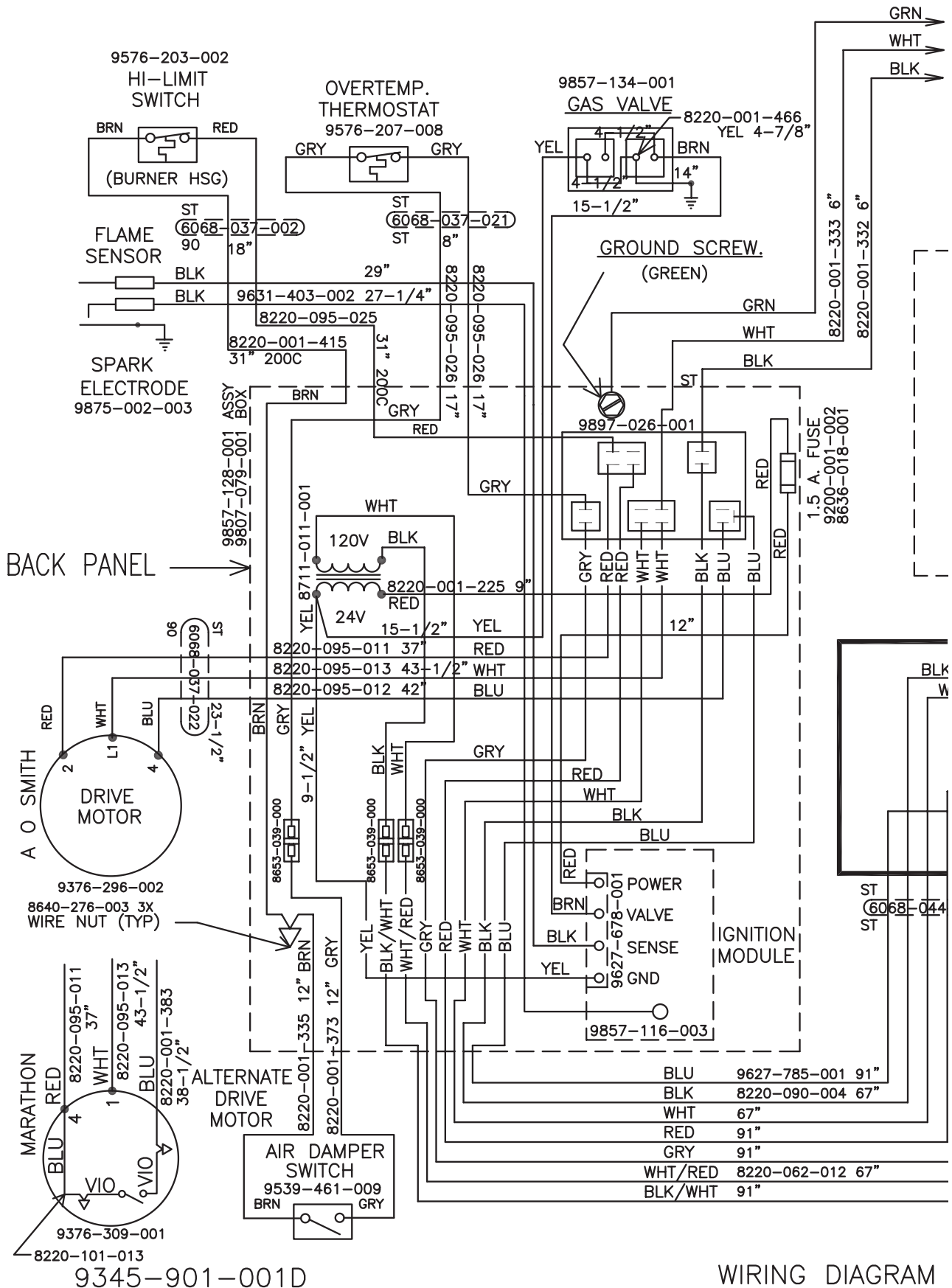

WIRING DIAGRAM



---

# **Section 6:**

Steam and  
Electric Heated  
Dryer: Parts and  
Wiring Diagrams

# Wiring Schematic for 60hz Steam Dryer -10FS

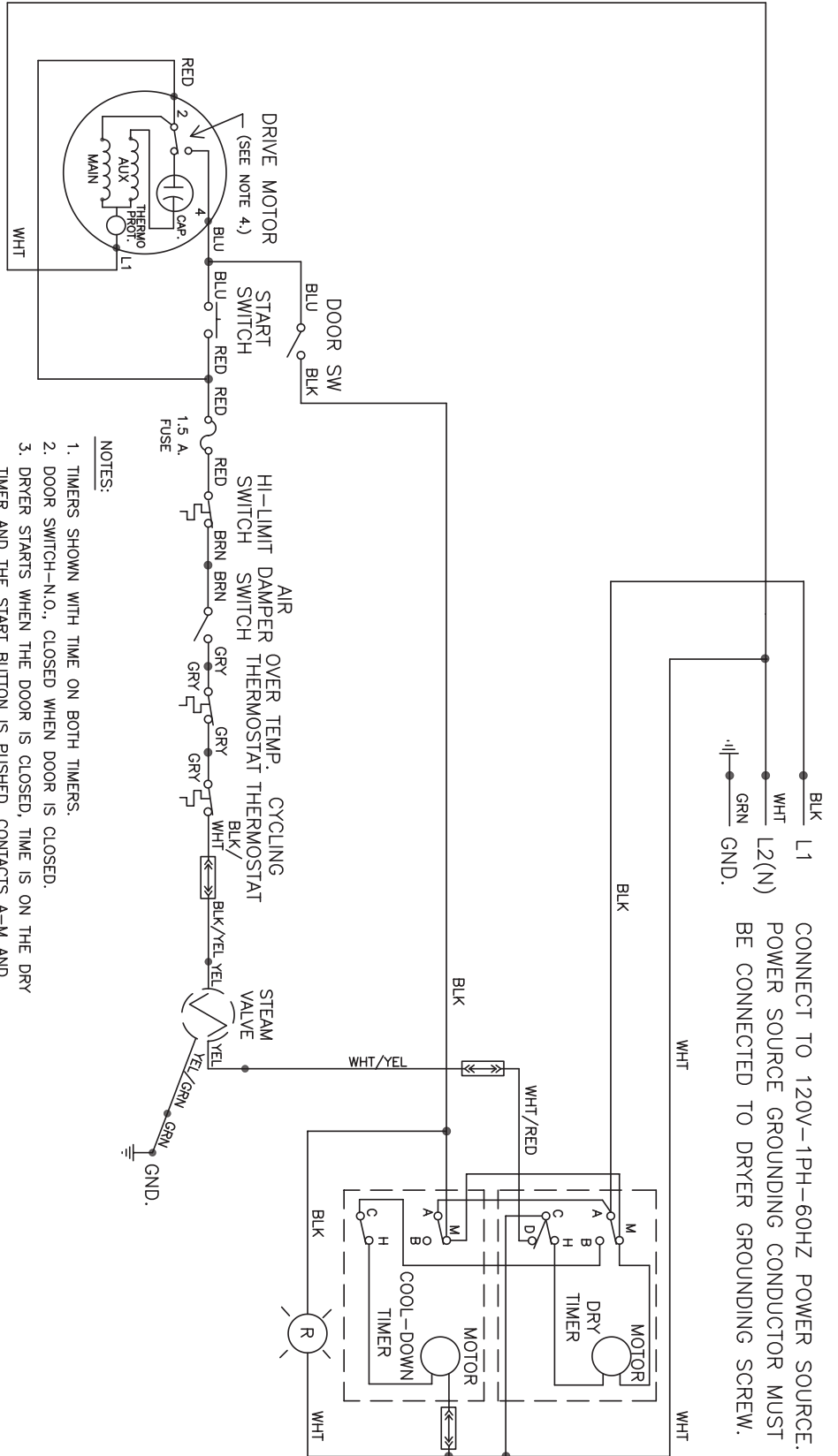

- NOTES:
1. TIMERS SHOWN WITH TIME ON BOTH TIMERS.
  2. DOOR SWITCH-N.O., CLOSED WHEN DOOR IS CLOSED.
  3. DRYER STARTS WHEN THE DOOR IS CLOSED, TIME IS ON THE DRY TIMER AND THE START BUTTON IS PUSHED. CONTACTS A-M AND C-H OPEN AT THE END OF THE TIMER CYCLE. C-D OPENS 2.4 MINUTES BEFORE THE END OF THE CYCLE FOR AN AUTOMATIC COOL DOWN.
  4. CENTRIFUGAL SWITCH-CONTACT CHANGES POSITION WHEN MOTOR IS UP TO SPEED.
  5. REFER TO OWNER'S MANUAL FOR DESCRIPTION OF OPERATION AND REQUIREMENTS FOR HEATING CIRCUIT.

9345-997-002PR

SCHEMATIC

D\_T\_30HT--10FS

# Wiring Diagram for 60hz Steam Dryer -10FS

9345-998-002PR

WIRING DIAGRAM

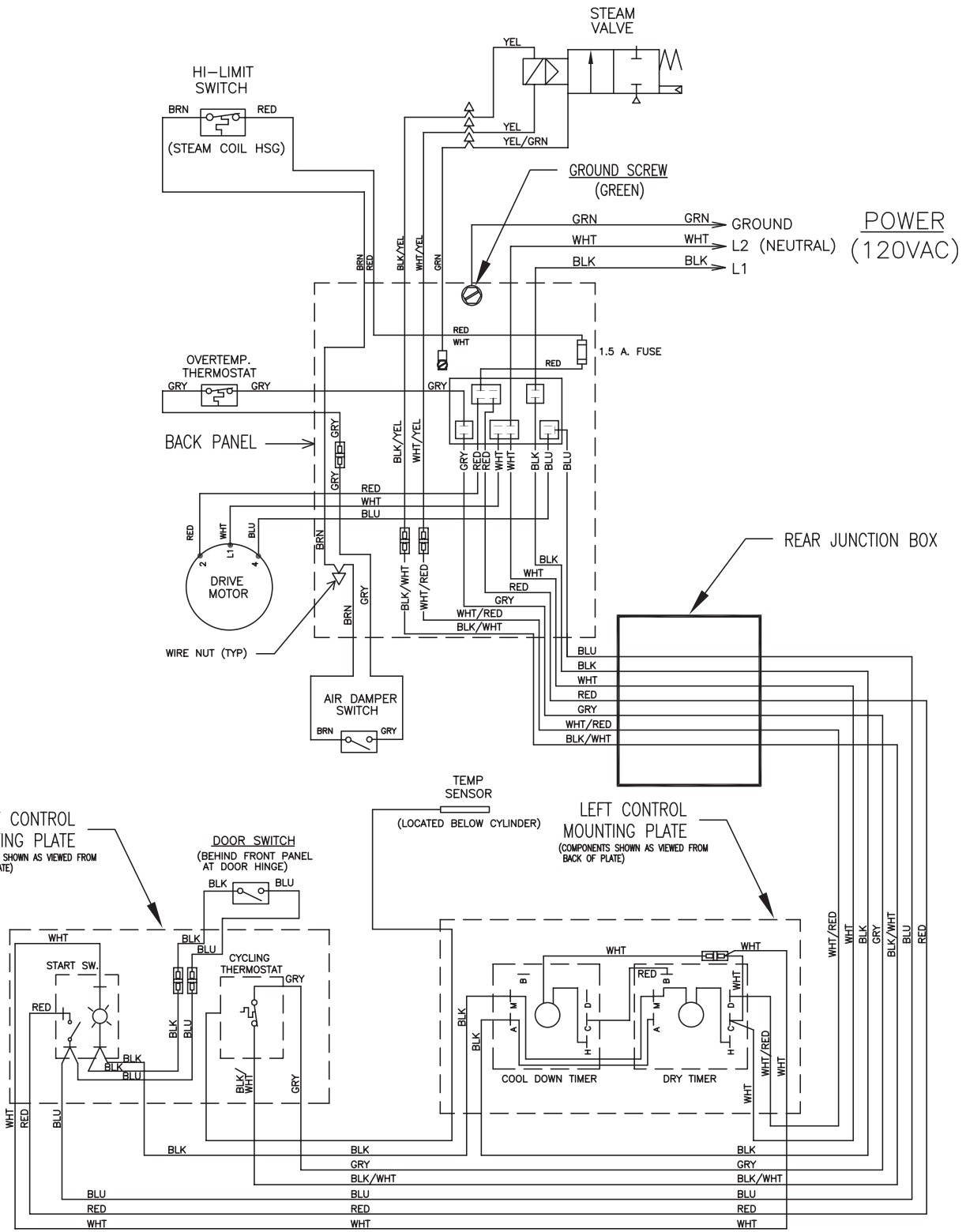

D\_T\_30HT\_16FC

# Wiring Schematic for Electric Dryer -16FC

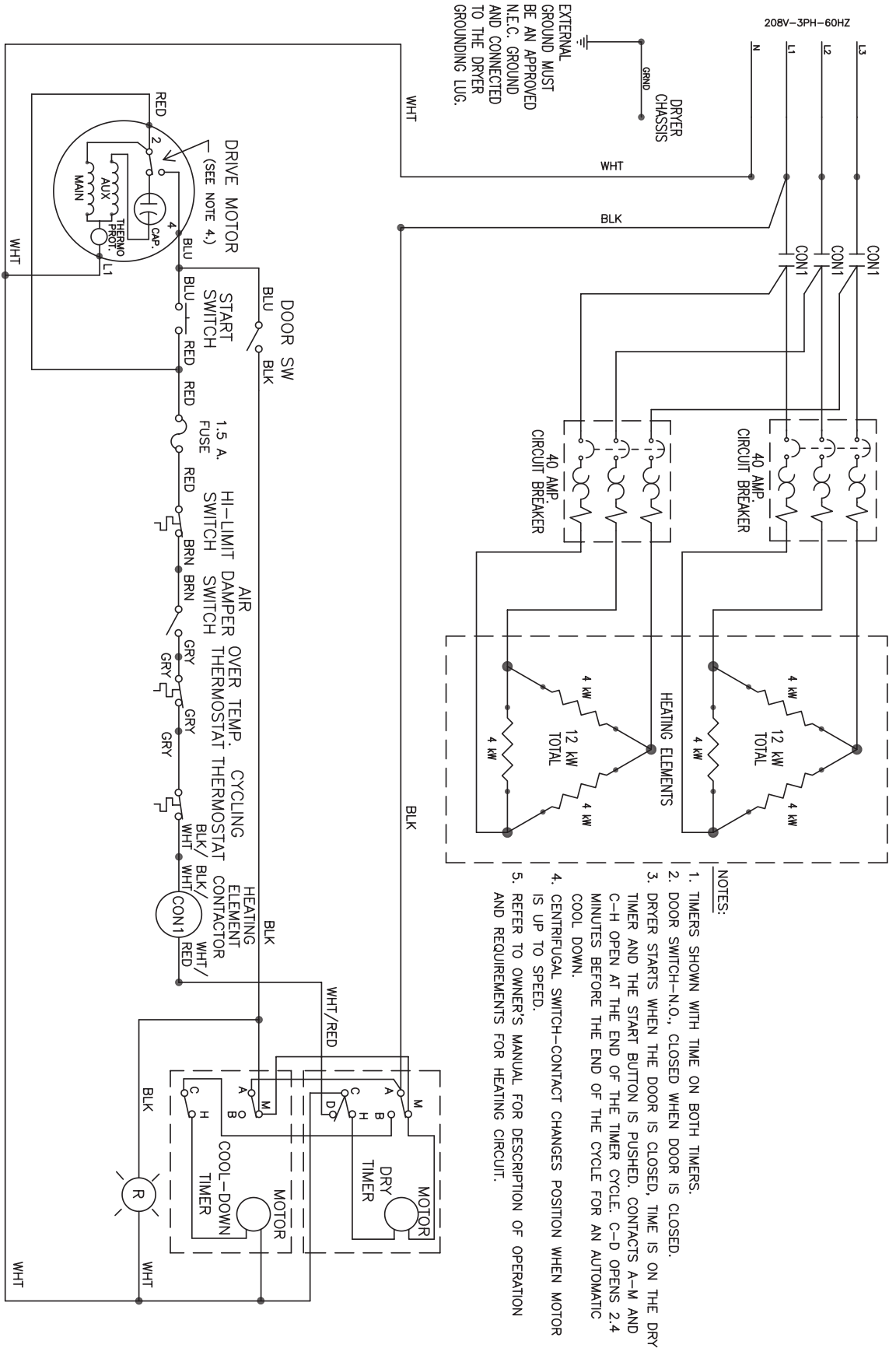

9345-989-002PR

SCHEMATIC

D\_T\_30HT\_-16FC

# Wiring Diagram for Electric Dryer -16FC

9345-990-002PR

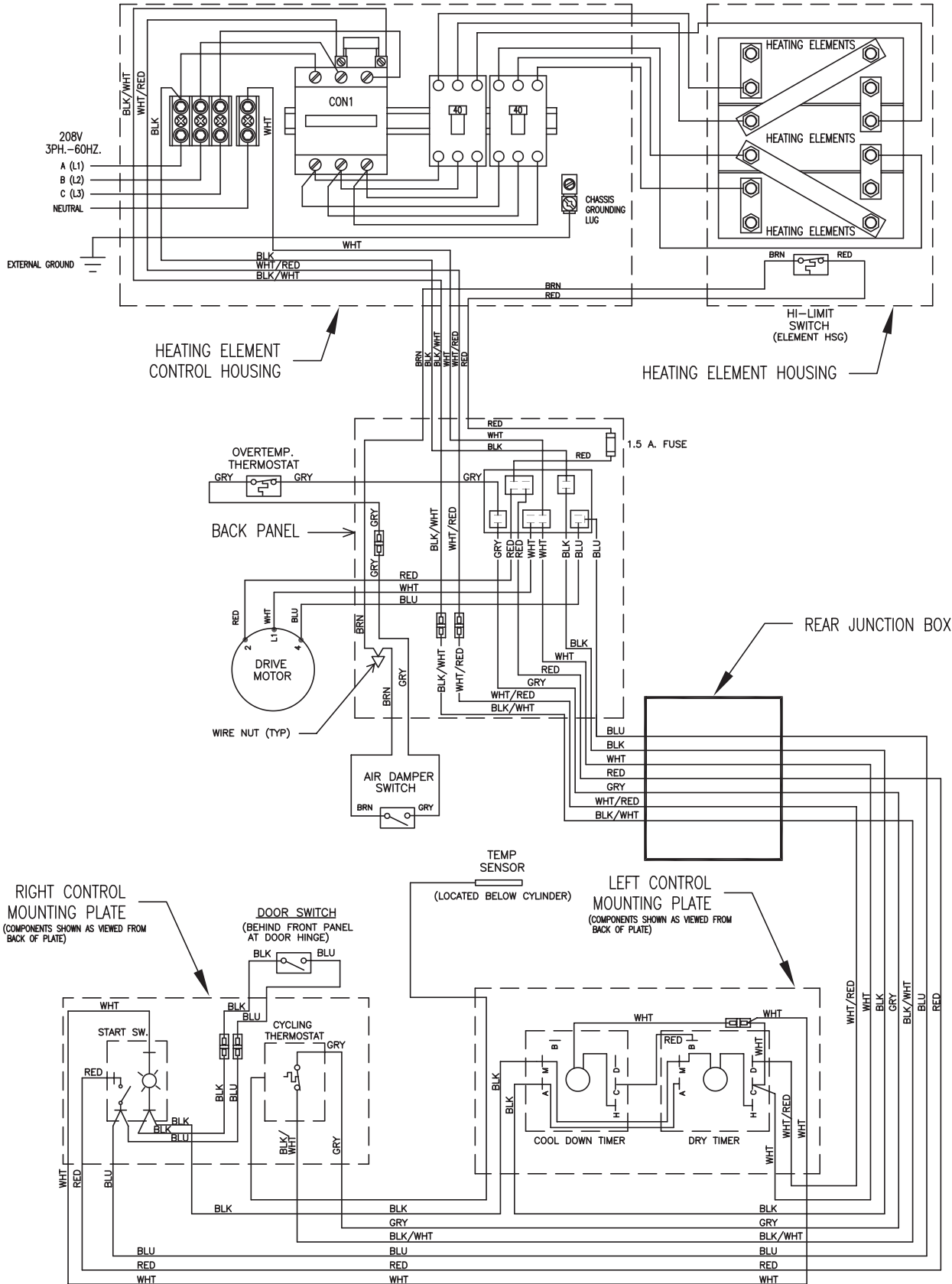

WIRING DIAGRAM

D\_T\_30HT\_16FC

# Wiring Schematic for Electric Dryer -18FD

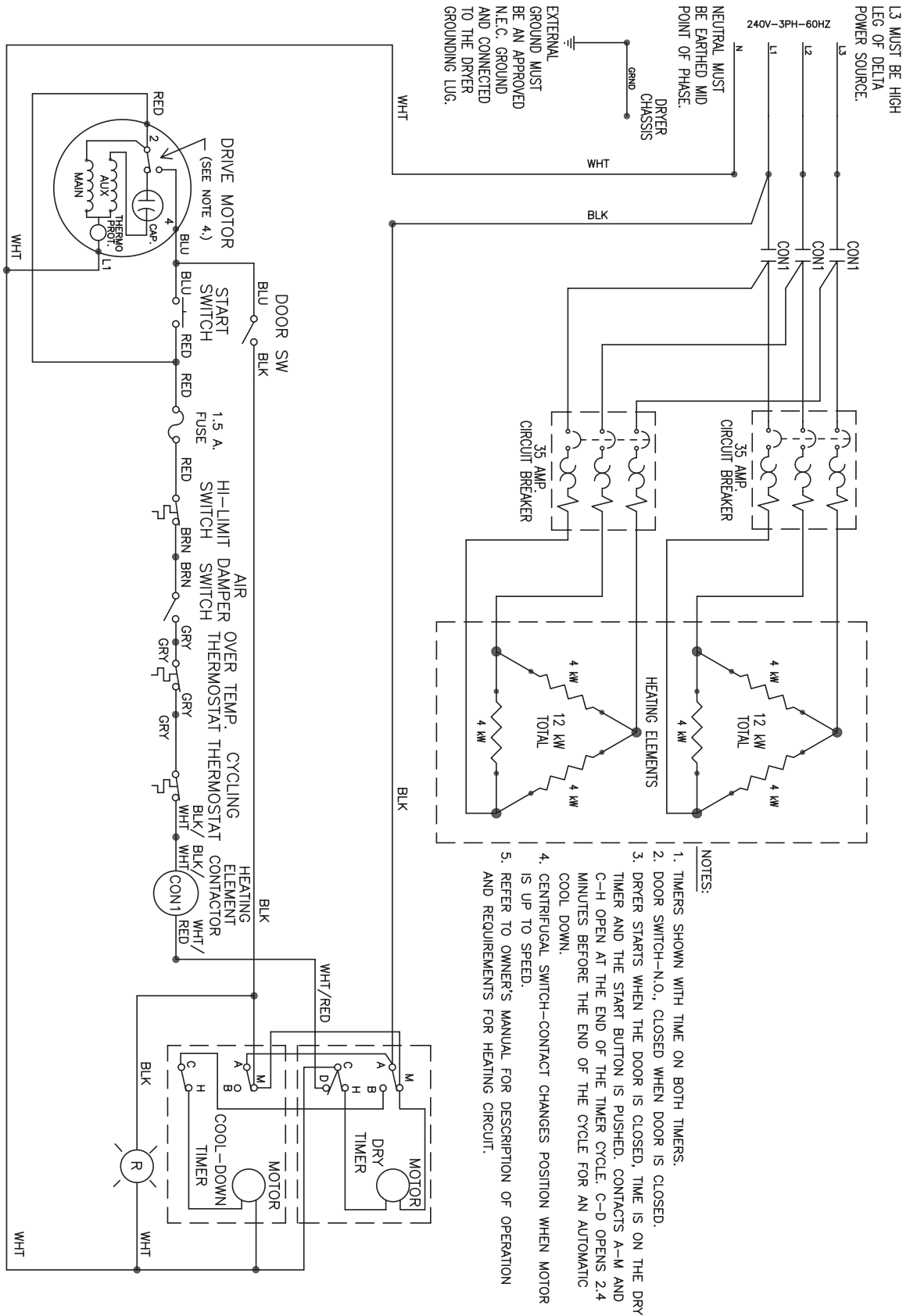

9345-977-002A

SCHEMATIC

D\_T\_30HT\_-18FD

# Wiring Diagram for Electric Dryer -18FD

9345-978-002A

WIRING DIAGRAM

D\_T\_30HT\_-18FD

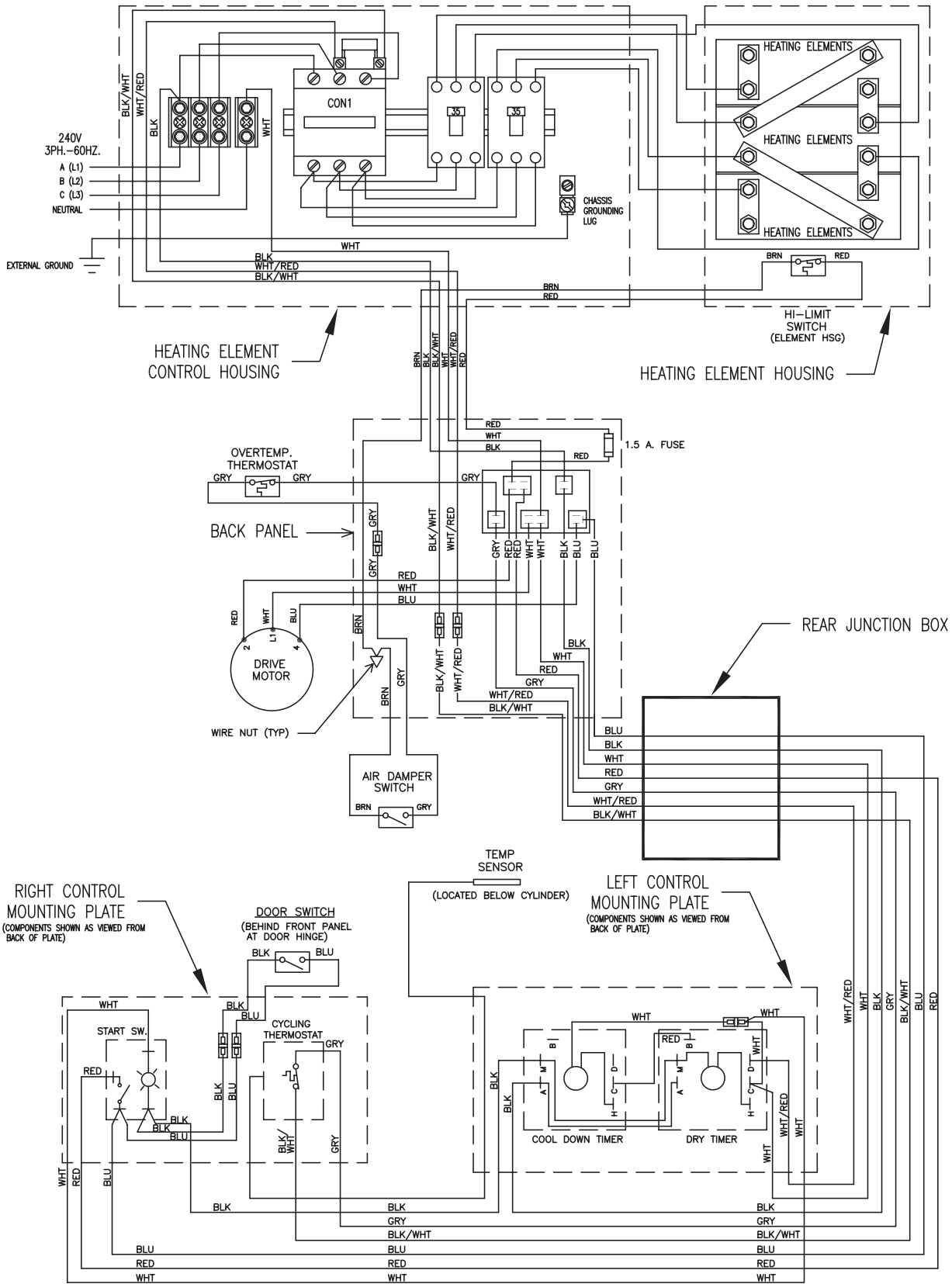

# Wiring Schematic for Electric Dryer -61FB

240V-60HZ.

EXTERNAL GROUND MUST BE AN APPROVED N.E.C. GROUND AND CONNECTED TO THE DRYER GROUNDING LUG.

L1  
L2  
N (NEUTRAL)  
NEUTRAL MUST BE EARTHED MID POINT OF PHASE.  
DRYER CHASSIS

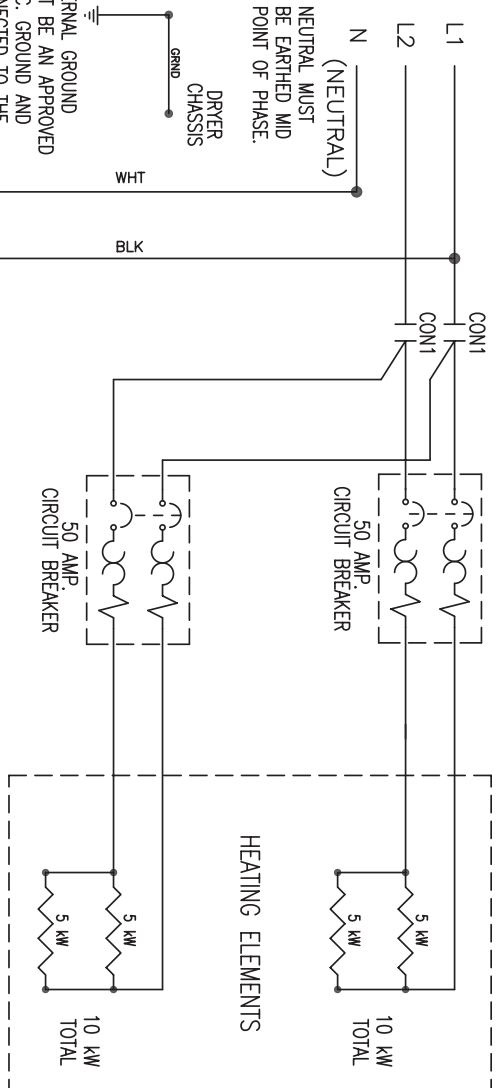

HEATING ELEMENTS

NOTES:

1. TIMERS SHOWN WITH TIME ON BOTH TIMERS.
2. DOOR SWITCH-N.O., CLOSED WHEN DOOR IS CLOSED.
3. DRYER STARTS WHEN THE DOOR IS CLOSED, TIME IS ON THE DRY TIMER AND THE START BUTTON IS PUSHED. CONTACTS A-M AND C-H OPEN AT THE END OF THE TIMER CYCLE. C-D OPENS 2.4 MINUTES BEFORE THE END OF THE CYCLE FOR AN AUTOMATIC COOL DOWN.
4. CENTRIFUGAL SWITCH-CONTACT CHANGES POSITION WHEN MOTOR IS UP TO SPEED.
5. REFER TO OWNER'S MANUAL FOR DESCRIPTION OF OPERATION AND REQUIREMENTS FOR HEATING CIRCUIT.

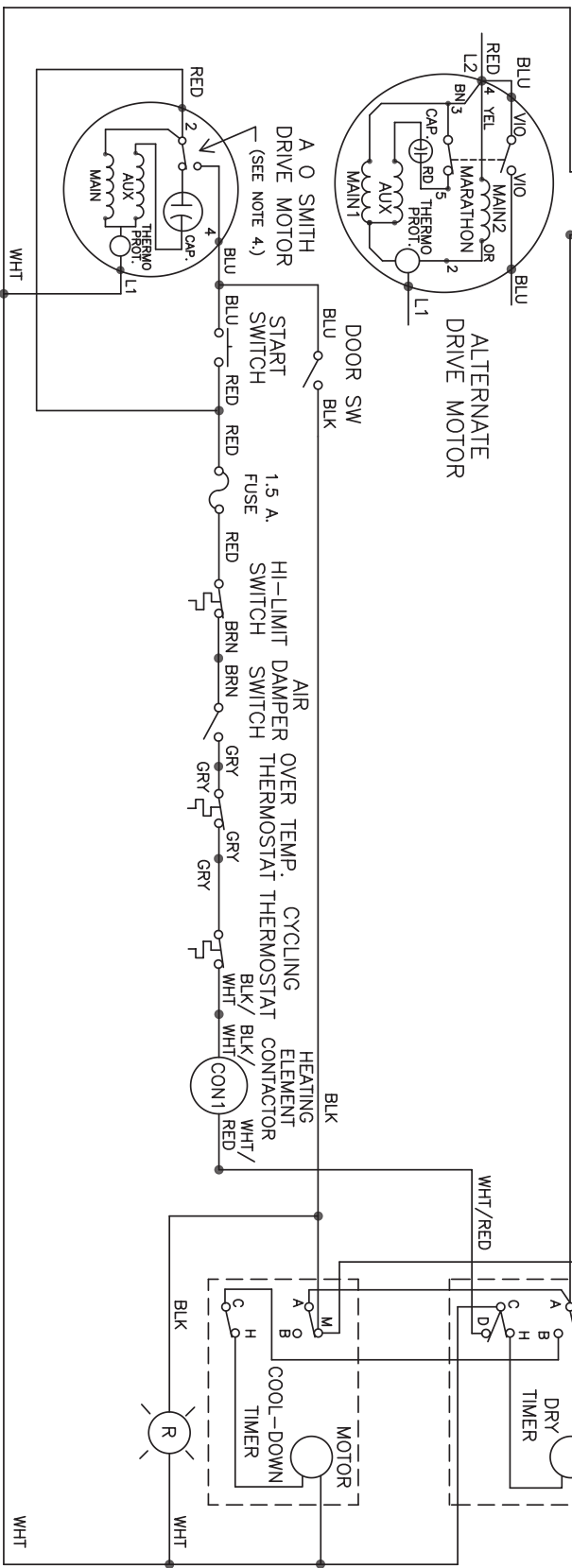

9506-094-001A

SCHEMATIC

D\_I\_30HT--61FB

# Wiring Diagram for Electric Dryer -61FB

9506-095-001A

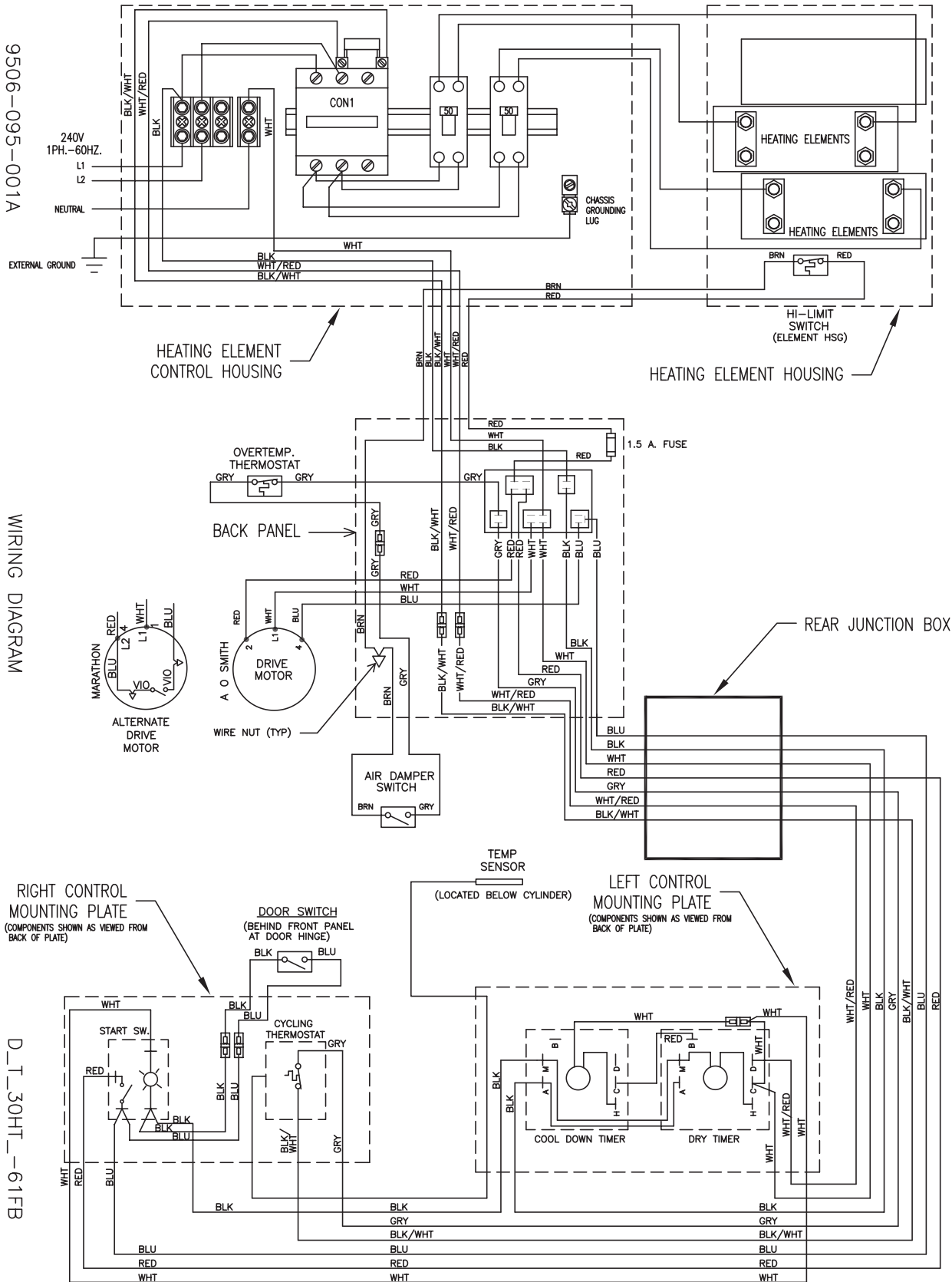

WIRING DIAGRAM

D\_T\_30HT\_61FB



# Wiring Diagram for Electric Dryer -60FA

9506-313-001A

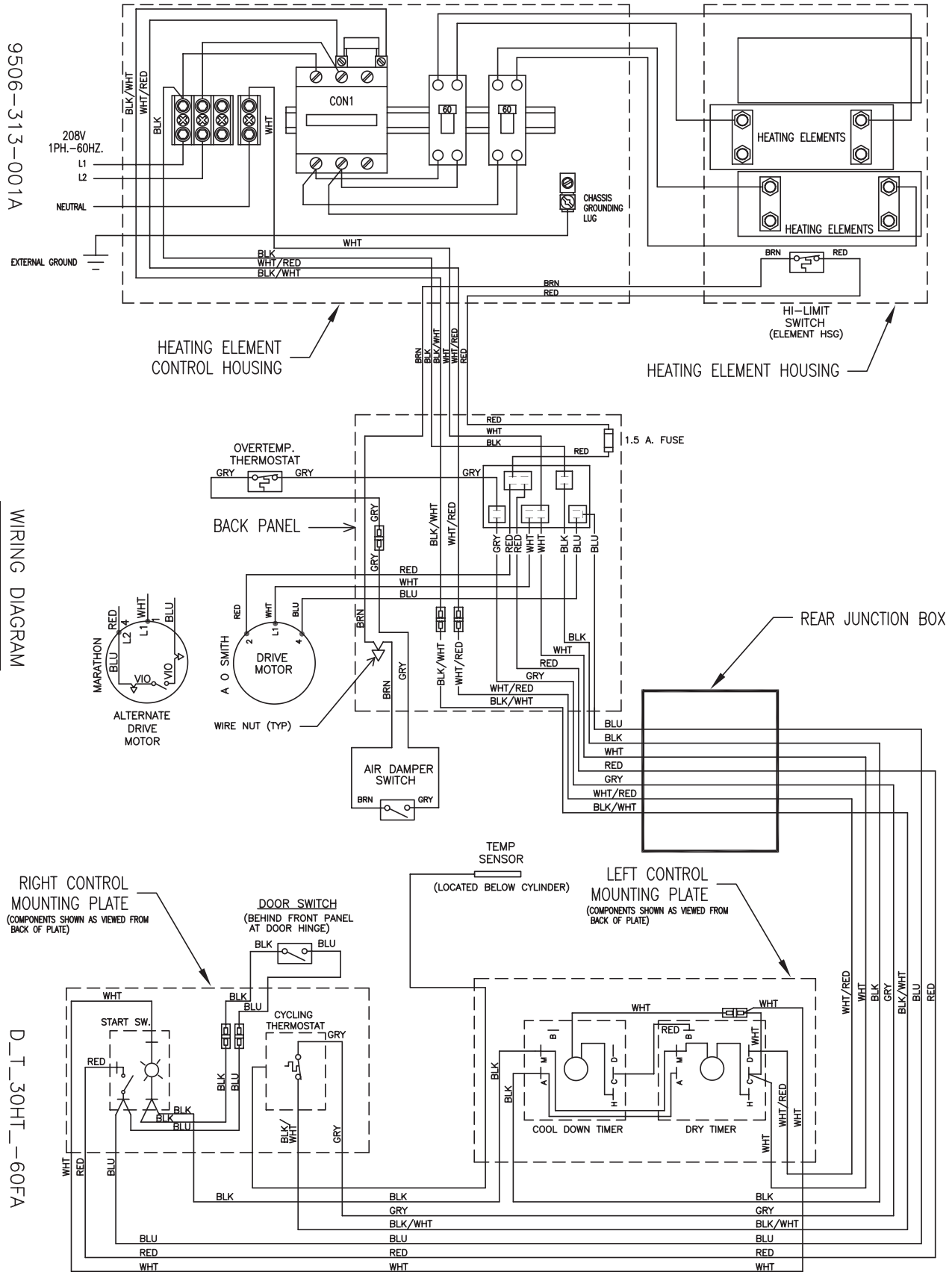

WIRING DIAGRAM

D\_T\_30HT\_60FA





## SWD Dryer Electric Heated DSTD30HT\_-16FC

Key	Description	Part Number	Qty
1	Relay-Con 1	5192-296-001	1
2	Circuit Breaker 40 Amp	5198-213-002	2
3	RAIL-DIN,35X15MM	9488-011-002	1
4	VARISTOR-COILSUPPRESSOR	9377-003-001	
5	BLOCK-POWER,3POLE	9897-037-001	1
6	BLOCK-POWER,1POLE	9897-038-001	1
7	HEATER-ELECTRICELEMENT	9870-093-004	3
*	LABEL-WARNING,HIGHVOLTAGE	8502-614-005	1
*	LABEL-WARNING	8502-639-001	1
*	LABEL-WARN,FIREHAZARD(FRENCH)	8502-702-001	1
*	LABEL-EXHAUSTWARNING	8502-708-001	2
*	LABEL-WARNINGFOR208V	8502-711-001	1
*	BOOKLET-OWNERS,SWD	8514-046-002	1
*	WIRINGLABEL-SCHEMATIC	9345-989-001	1
*	WIRINGLABEL-DIAGRAM	9345-990-001	1
*	JUMPER-FORMED (see Drawing Page 74)	9295-004-002	2
*	JUMPER-STRAIGHT (see Drawing Page 74)	9295-005-002	4
8	High Limit Thermostat (see Drawing Page 74 for mounting)	9576-203-002	1

## SWD Dryer Electric Heated DSTD30HT\_-18FC

Key	Description	Part Number	Qty
1	Relay-Con 1	5192-296-001	1
2	Circuit Breaker 40 Amp	5198-213-001	2
3	RAIL-DIN,35X15MM	9488-011-002	1
4	VARISTOR-COILSUPPRESSOR	9377-003-001	1
5	BLOCK-POWER,3POLE	9897-037-001	1
6	BLOCK-POWER,1POLE	9897-038-001	1
7	HEATER-ELECTRICELEMENT	9870-093-003	3
*	LABEL-WARNING,HIGHVOLTAGE	8502-614-005	1
*	LABEL-WARNING	8502-639-001	1
*	LABEL-WARN,FIREHAZARD(FRENCH)	8502-702-001	1
*	LABEL-EXHAUSTWARNING	8502-708-001	2
*	LABEL-WARNINGFOR208V	8502-711-001	1
*	BOOKLET-OWNERS,SWD	8514-046-002	1
*	WIRINGLABEL-SCHEMATIC	9345-976-001	1
*	WIRINGLABEL-DIAGRAM	9345-977-001	1
*	JUMPER-FORMED (see Drawing Page 74)	9295-004-002	2
*	JUMPER-STRAIGHT (see Drawing Page 74)	9295-005-002	4
8	High Limit Thermostat (see Drawing Page 74 for mounting)	9576-203-002	1

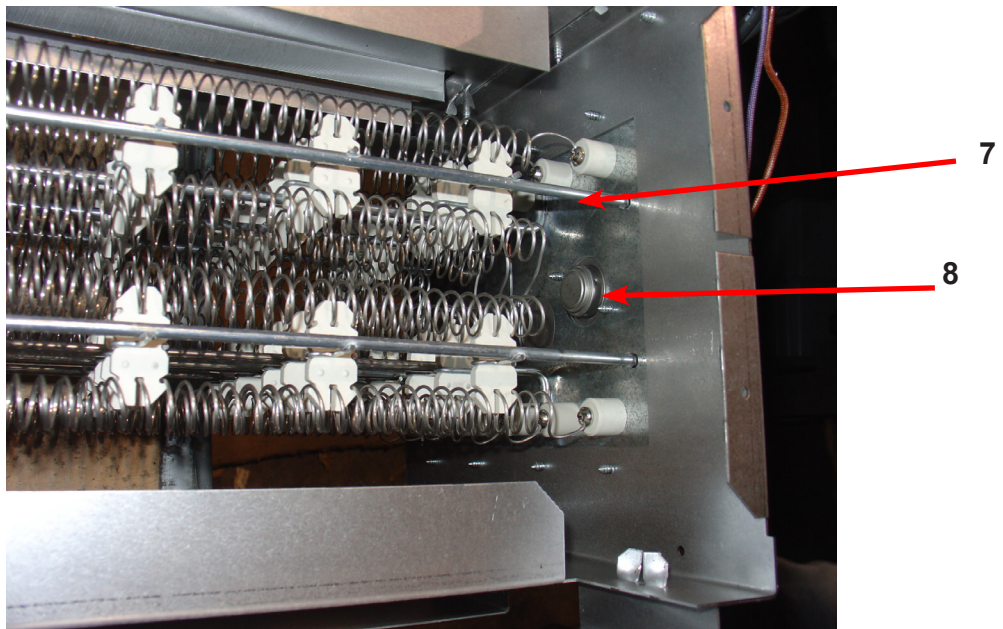
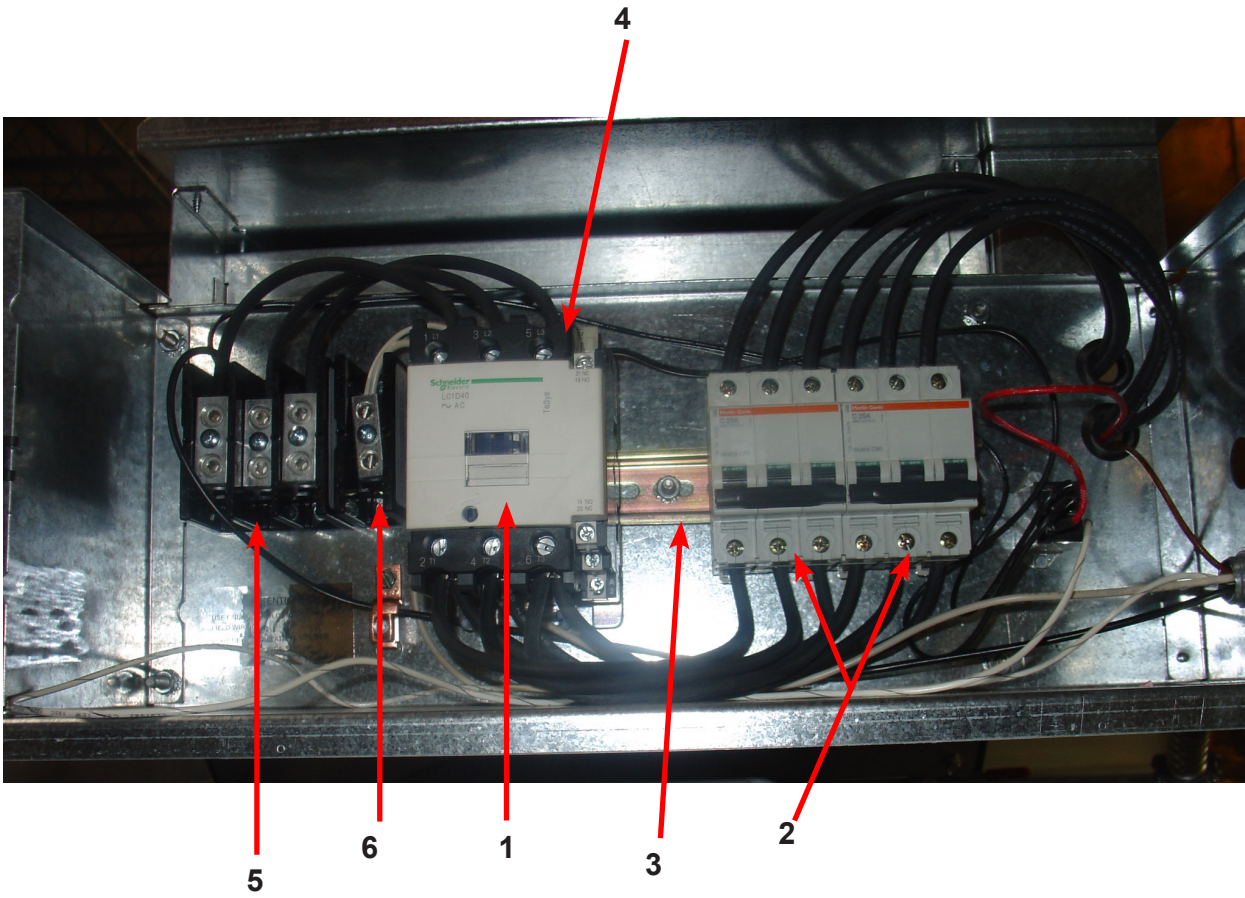

7

THREAD THERMOSTAT & FRONT HEATER WIRES THROUGH BUSHING IN SUPPORT.  
TOP HEATER REPLACED WITH 9452-711-001 PLATE WHEN REQUIRED

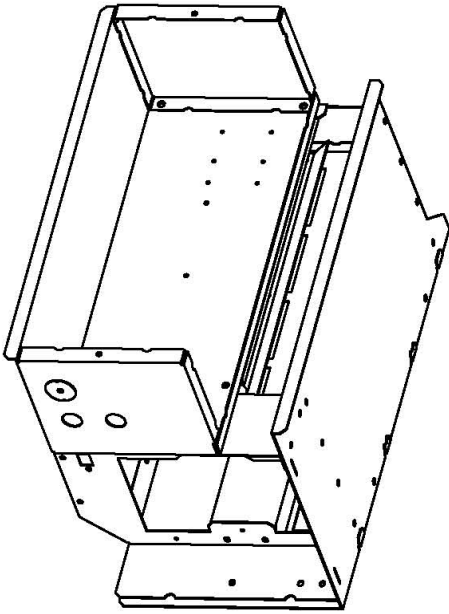

HEATER  
AS REQUIRED

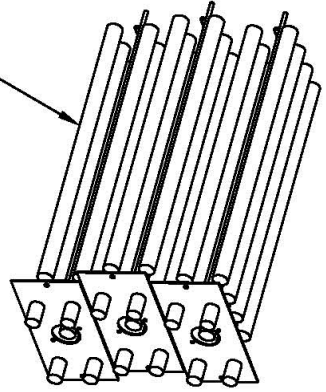

9074-293-001  
COVER-PLATE - AS REQUIRED

9548-283-001  
SUPPORT-WIRE

9576-203-002  
THERMOSTAT-HIGH LIMIT

9295-004-002 & 9295-005-002  
JUMPERS - AS REQUIRED

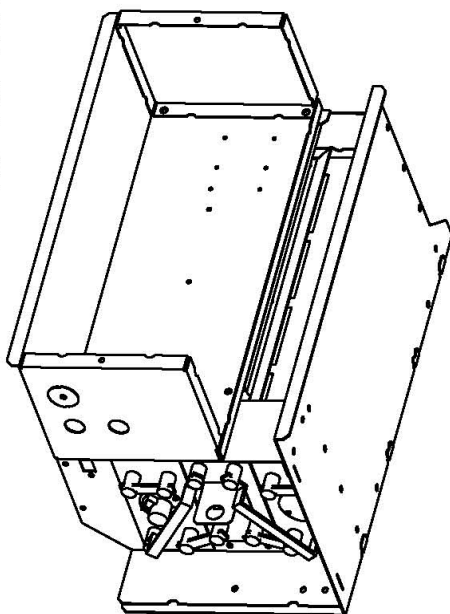

9545-045-008 SCREW (AS REQUIRED)

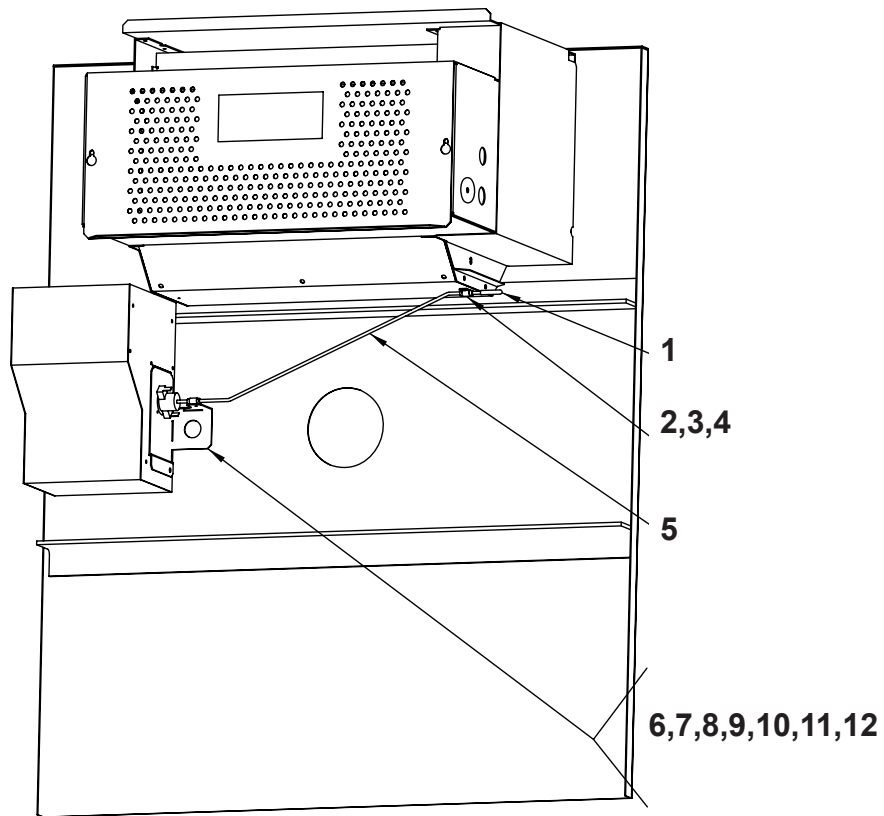

Key	Description	Part Number	Qty
1	Cap, Actuator-Red	0935-133-001	1
2	Spacer, Actuator	9538-157-003	1
3	Clamp, Actuator	9079-121-002	1
4	Screw, Clamp	9545-035-004	1
5	Actuator, Rod	9008-009-001	1
6	Bracket, Overtemp Thermostat	9029-136-001	1
7	Screw, Bracket	9545-008-024	2
8	Spacer, Thermostat	9538-157-003	2
9	Thermostat, Overtemp (resetable)	9576-207-008	1
10	Screw, Thermostat	9545-045-008	2
11	Clamp (Thermostat to Actuator)	9079-121-002	1
12	Screw (Clamp thermostat to Actuator)	9545-035-004	1

---

## SWD Dryer Electric Heated DATD30HC\_-61FB

Key	Description	Part Number	Qty
9	RELAY-125AMP(REISTIVE)CONTACT	5192-294-001	1
10	CIRCUITBREAKER-2POLE	5198-214-001	2
11	BLOCK-POWER,3POLE	9897-037-001	1
12	BLOCK-POWER,1POLE	9897-0378001	1
*	WIRINGLABEL-SCHEMATIC	9345-987-002	1
*	WIRINGLABEL-DIAGRAM	9345-988-002	1

## SWD DRYER Electric Heated DSTD30HC\_-60FA

Key	Description	Part Number	Qty
9	RELAY-125AMP(REISTIVE)CONTACT	5192-294-001	1
10	CIRCUITBREAKER-2POLE	5198-214-001	2
11	BLOCK-POWER,3POLE	9897-037-001	
12	BLOCK-POWER,1POLE	9897-038-001	
*	WIRINGLABEL-SCHEMATIC	9506-214-002	1
*	WIRINGLABEL-DIAGRAM	9506-215-002	1
*	HEATER-ELECTRICELEMENT	9870-093-002	2

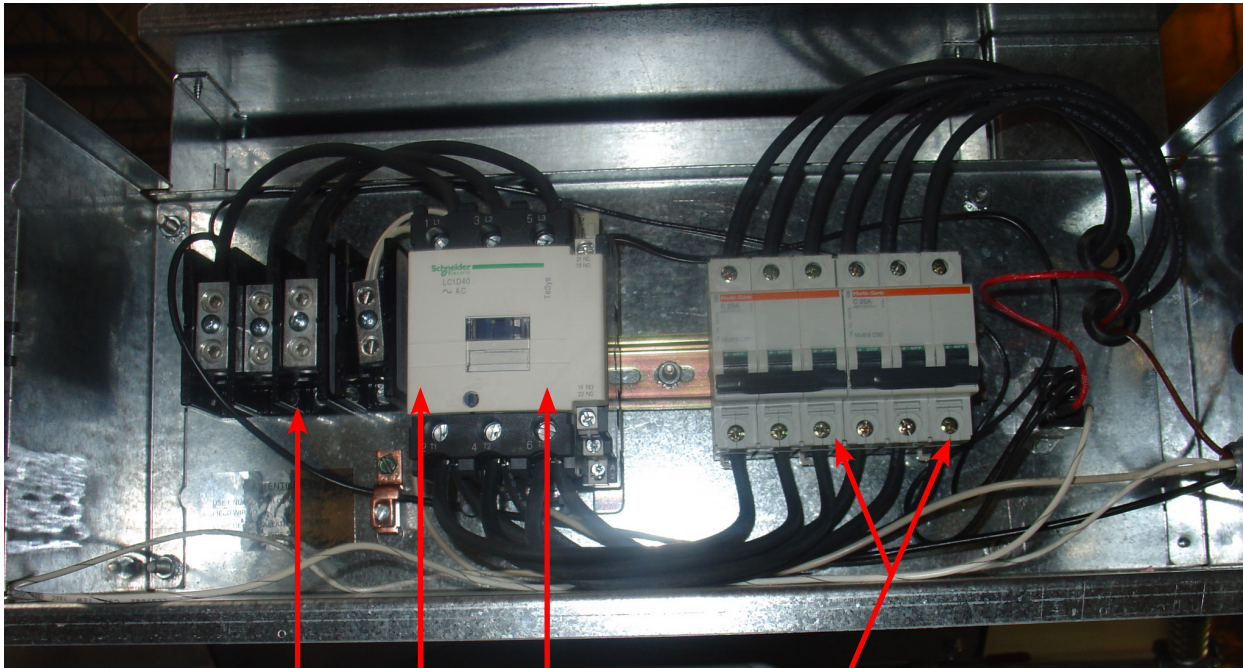

11

12

9

10

# SWD Dryer Steam Heated 60hz Steam Dryer -10FS

Key	Description	Part Number	Qty
1	Coil-Heating, Steam	9089-046-001	1
2	Valve-Solenoid, Steam	9379-193-001	1
*	Label-Coil Lint screen	8502-717-001	1
*	Booklet, Owners	8514-075-001	1
*	Diagram-Wiring Label	9345-998-002	1
*	Schematic-Wiring Label	9345-997-002	1

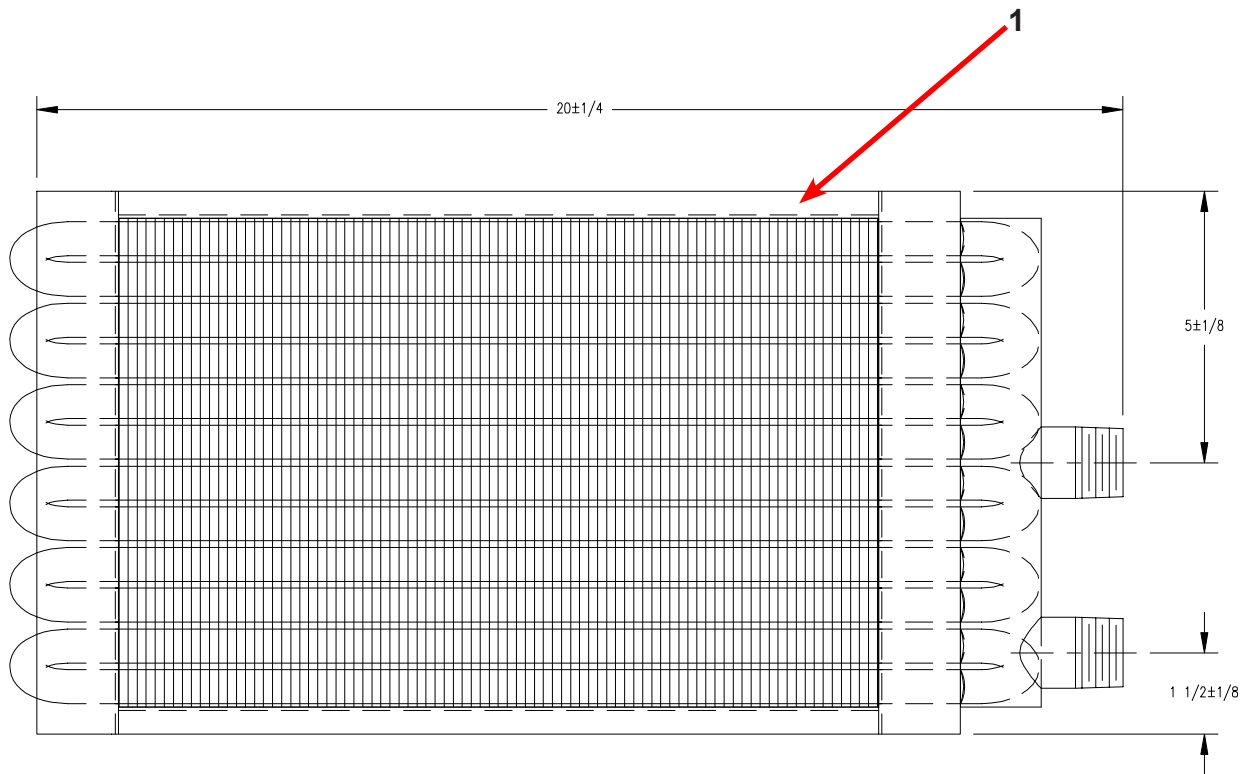

Screen Assembly see Page 81

1

2

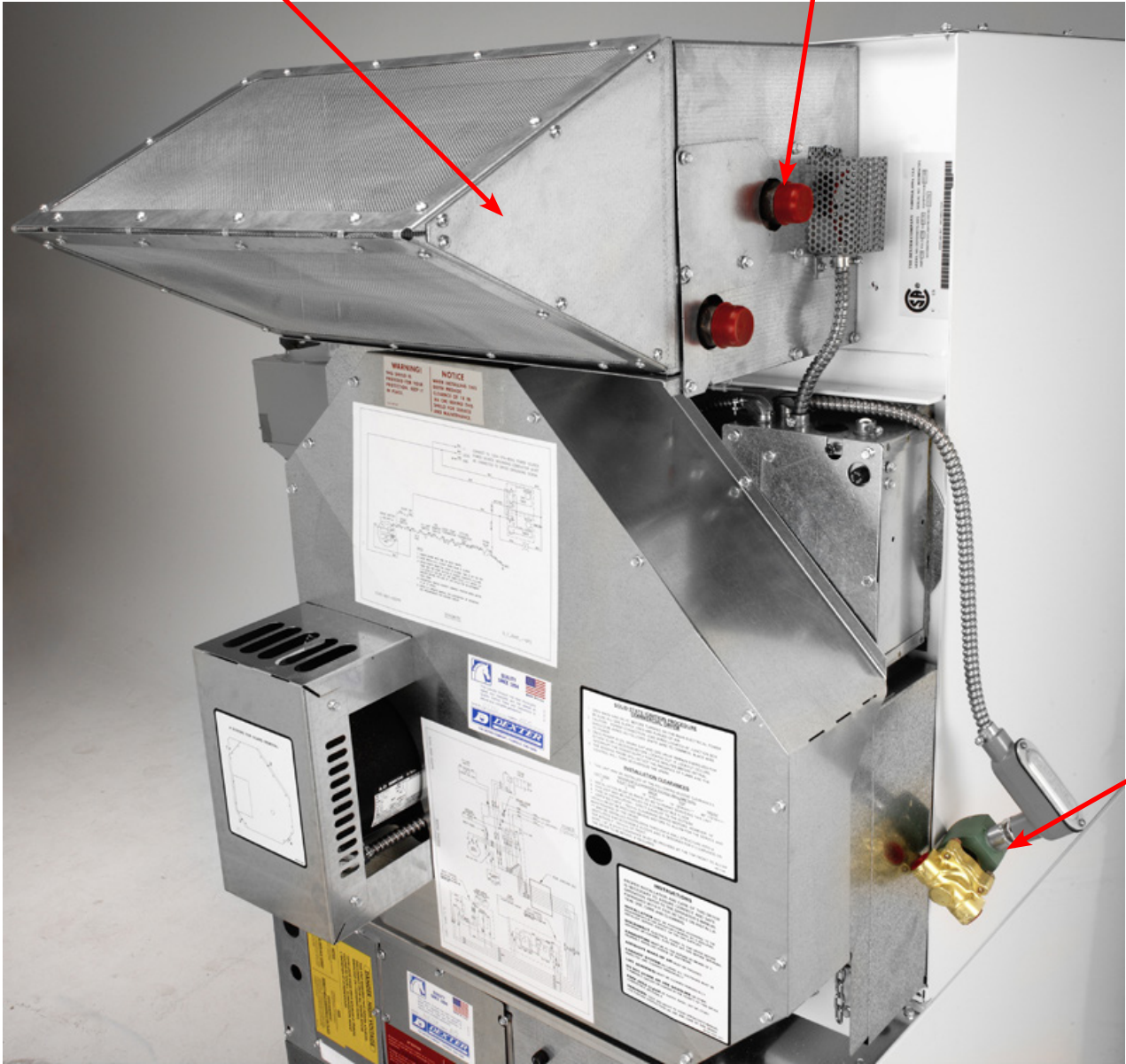

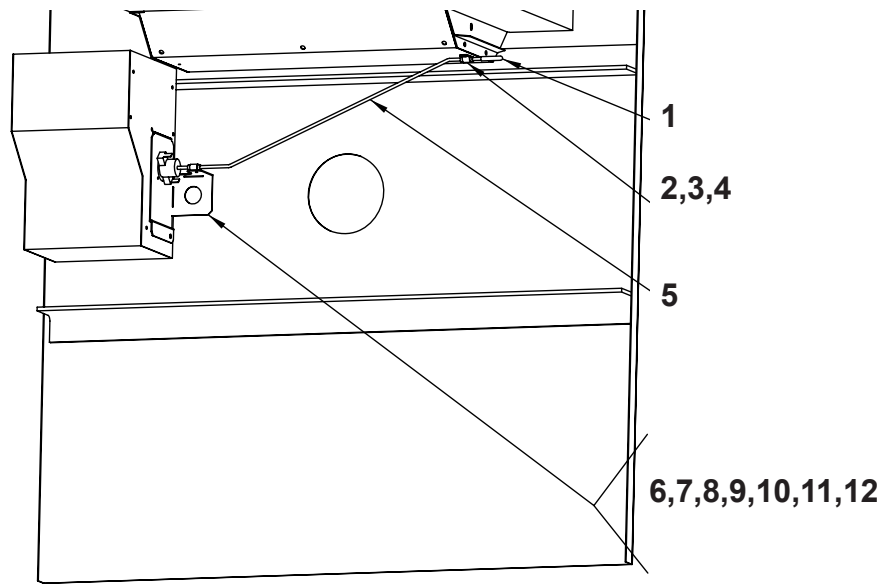

Key	Description	Part Number	Qty
1	Cap, Actuator-Red	0935-133-001	1
2	Spacer, Actuator	9538-157-003	1
3	Clamp, Actuator	9079-121-002	1
4	Screw, Clamp	9545-035-004	1
5	Actuator, Rod	9008-009-001	1
6	Bracket, Overtemp Thermostat	9029-136-001	1
7	Screw, Bracket	9545-008-024	2
8	Spacer, Thermostat	9538-157-003	2
9	Thermostat, Overtemp (resetable)	9576-207-008	1
10	Screw, Thermostat	9545-045-008	2
11	Clamp (Thermostat to Actuator)	9079-121-002	1
12	Screw (Clamp thermostat to Actuator)	9545-035-004	1

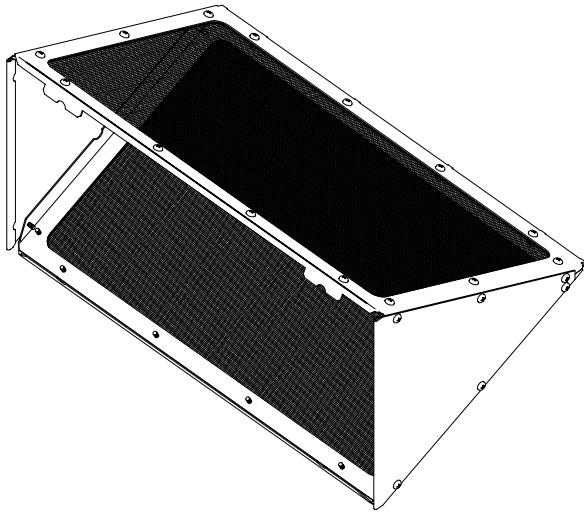
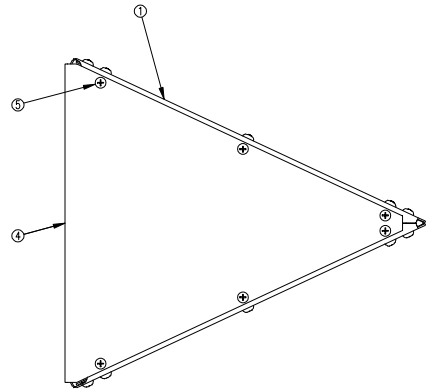
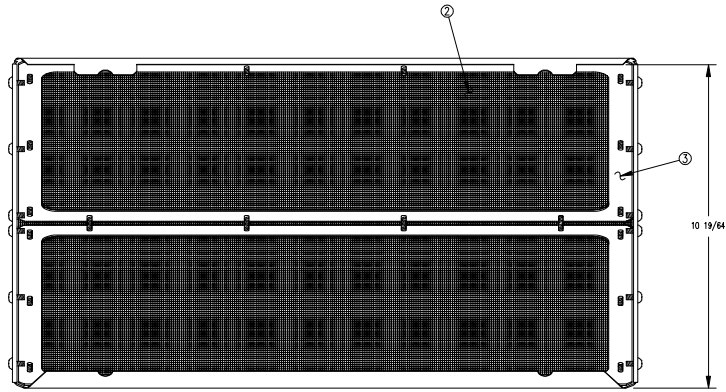

Key	Description	Part Number	Qty
	Lint Screen Assy (includes 1-5)		1
1	Frame- Lint Screen, Intake Steam	9181-030-001	1
2	Screen-Lint	9555-057-005	1
3	Retainer-Lint Screen	9486-153-001	2
4	Side-Lint Screen Assy, Intake	9551-034-001	2
5	Screw-10B x 3/8	9545-008-021	40



---

# **Section 7:**

## 50 Hz Gas Dryer

Key	Description	Part Number	Qty
1	FILTER-LINE,EMI	9183-030-001	1
	FILTER-EMI,3A,115/250V	9183-047-001	1
*	MOTOR-DRY,MRTHON(30#STK),50HZ (Visually the same as 60HZ)	9376-318-001	1
*	PULLEY-DRIVE,MACHINED	9453-169-009	1
2	CONTROLSASSEMBLY-FENWAL	9857-140-001	1
*	CONTROLSASY-ELEC,STKW/D(W/IR)	9857-148-002	1
3	TRANSFORMER-CONTROL	8711-008-002	1
*	RELAY, Motor Control	5192-288-001	1
*	INSTRUCTIONS-TRANSFORMCONNECT	8507-230-003	1
*	INSTRUCTIONS-AUSSIEADDENDUM	8507-298-001	1
*	LABEL-AUSSIEWARNING	8502-698-001	1
*	WIRINGLABEL-SCHEMATIC (-21)	9345-904-001	1
*	WIRINGLABEL-DIAGRAM (-21)	9345-905-001	1

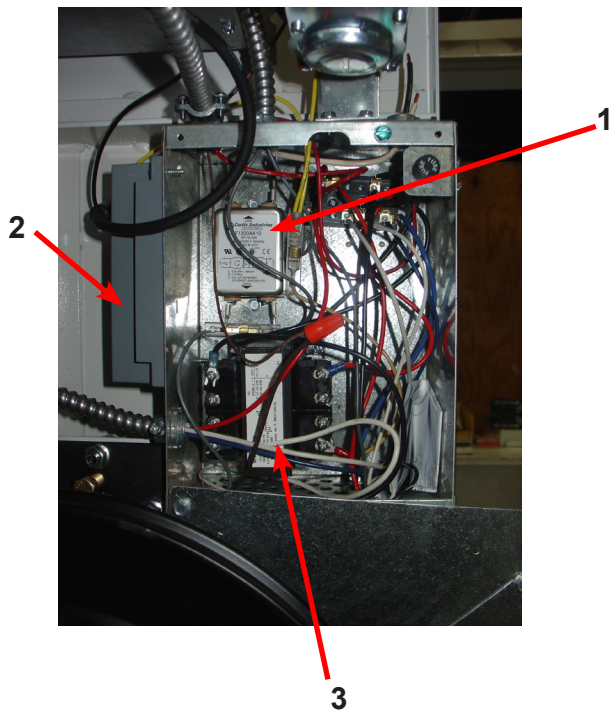

Key	Description	Part Number	Qty
4	KIT-HONEYWELLVR86VALVEFLANGE	9732-162-001	2
5	CONTROLASSEMBLY-GAS	9857-132-004	1
*	Orifice-Natural, #32	9425-069-009	2
*	LP Conversion Kit	9732-179-001	1
*	Orifice-LP, #50	9425-069-008	2



# Wiring Schematic for Dryer 50hz 230V -21

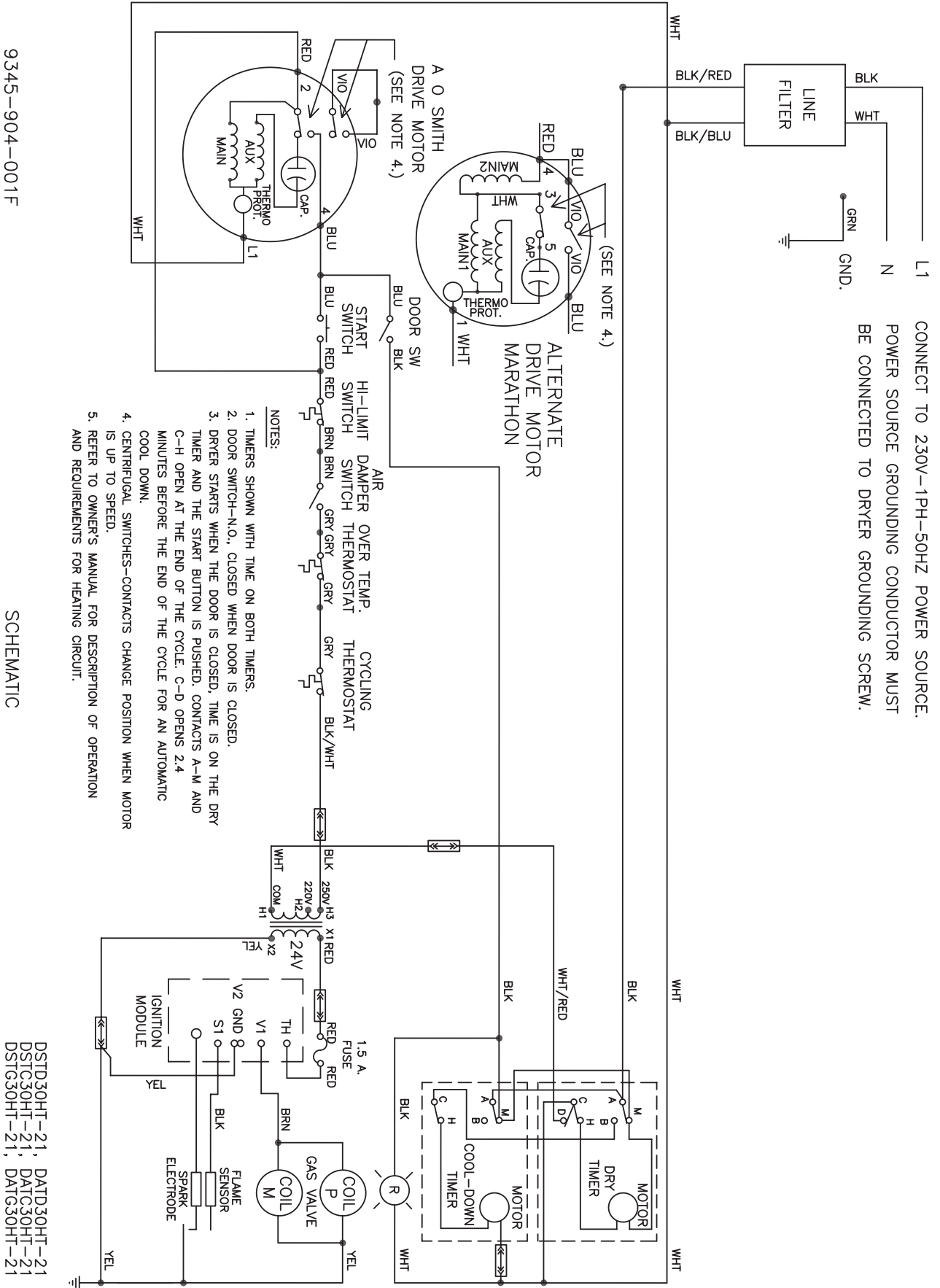

9345-904-001F





---

# **Section 8:**

50 Hz Electric  
Heated Dryer:  
Parts and  
Wiring Diagrams

## SWD Dryer Electric Heated DSTD30HT\_-27FL

Key	Description	Part Number	Qty
1	Relay-Con 1	5192-294-001	1
2	Circuit Breaker 40 Amp	5198-214-001	2
3	RAIL-DIN,35X15MM	9488-011-002	1
4	VARISTOR-COILSUPPRESSOR	9377-003-001	1
5	BLOCK-POWER,3POLE	9897-037-001	1
7	HEATER-ELECTRICELEMENT	9870-093-005	3
*	LABEL-WARNING,HIGHVOLTAGE	8502-614-005	1
*	LABEL-WARNING	8502-639-001	1
*	LABEL-WARN,FIREHAZARD(FRENCH)	8502-702-001	1
*	LABEL-EXHAUSTWARNING	8502-708-001	2
*	LABEL-WARNINGFOR208V	8502-711-001	1
*	BOOKLET-OWNERS,SWD	8514-067-001	1
*	WIRINGLABEL-SCHEMATIC	9506-185-001	1
*	WIRINGLABEL-DIAGRAM	9506-186-001	1
8	JUMPER-STRAIGHT (see Drawing Page 88)	9295-005-002	4
9	High Limit Thermostat (see Drawing Page 88 for mounting)	9576-203-002	1

## SWD Dryer Electric Heated DSTD30HT\_-29FN

Key	Description	Part Number	Qty
1	Relay-Con 1	5192-291-002	1
2	Circuit Breaker 25Amp	5198-215-002	2
3	RAIL-DIN,35X15MM	9488-011-002	1
4	VARISTOR-COILSUPPRESSOR	9377-003-001	
5	BLOCK-POWER,3POLE	9897-037-001	1
6	BLOCK-POWER,1POLE	9897-038-001	1
7	HEATER-ELECTRICELEMENT	9870-095-002	3
*	LABEL-WARNING,HIGHVOLTAGE	8502-614-005	1
*	LABEL-WARNING	8502-639-001	1
*	LABEL-WARN,FIREHAZARD(FRENCH)	8502-702-001	1
*	LABEL-EXHAUSTWARNING	8502-708-001	2
*	LABEL-WARNINGFOR208V	8502-711-001	1
*	BOOKLET-OWNERS,SWD	8514-067-001	1
*	WIRINGLABEL-SCHEMATIC	9506-348-001	1
*	WIRINGLABEL-DIAGRAM	9506-349-001	1
*	Wire Jumper (See Wiring Informitive)	8220-060-003	2
8	JUMPER-STRAIGHT (see Drawing Page 88)	9295-005-002	2
9	High Limit Thermostat (see Drawing Page 88 for mounting)	9576-203-002	1

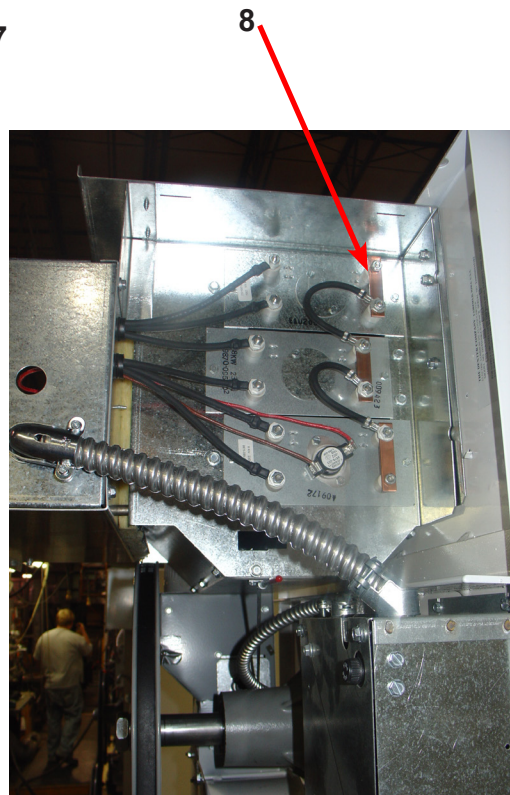
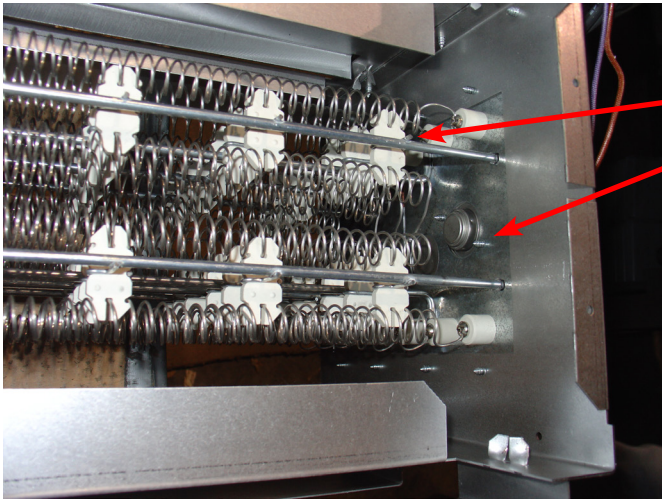
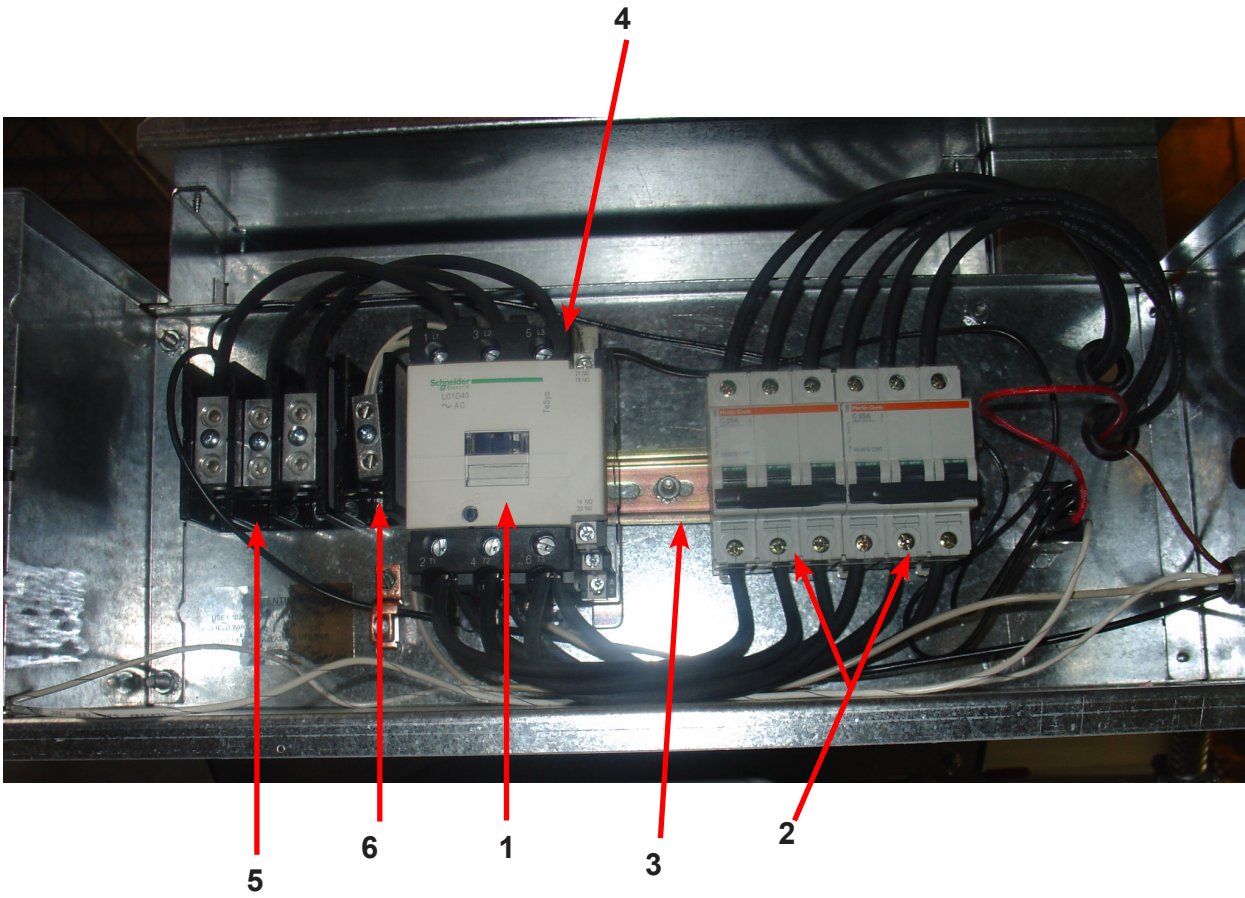

7  
 THREAD THERMOSTAT & FRONT HEATER WIRES THROUGH BUSHING IN SUPPORT.  
 TOP HEATER REPLACED WITH 9452-711-001 PLATE WHEN REQUIRED

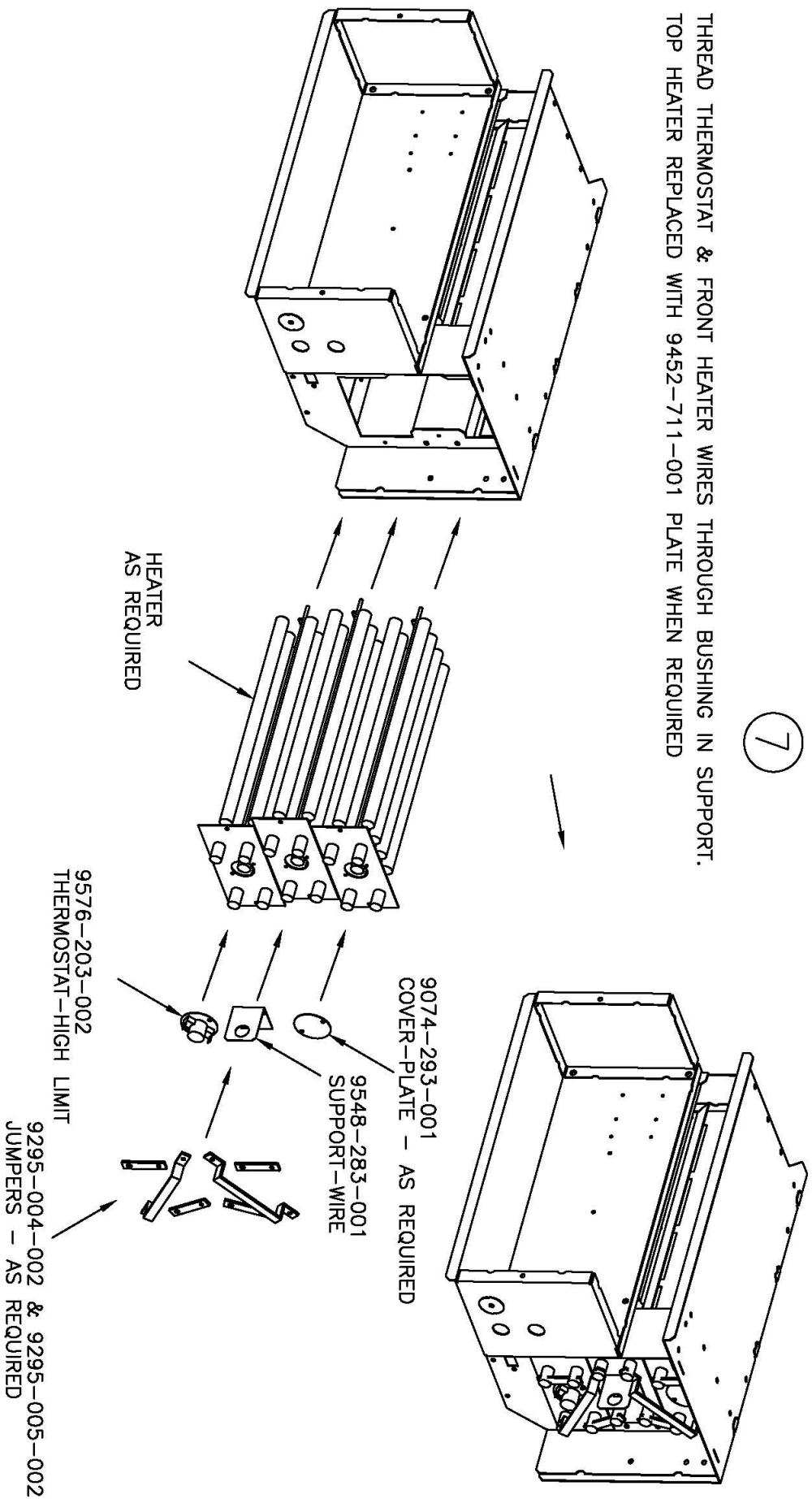

9545-045-008 SCREW (AS REQUIRED)

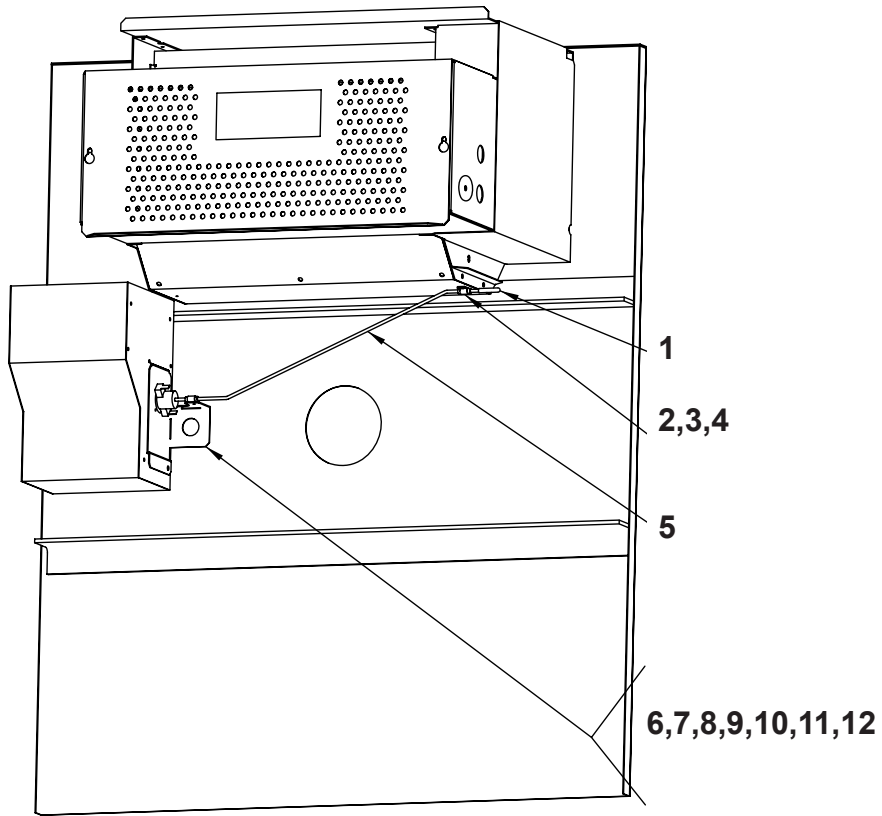

Key	Description	Part Number	Qty
1	Cap, Actuator-Red	0935-133-001	1
2	Spacer, Actuator	9538-157-003	1
3	Clamp, Actuator	9079-121-002	1
4	Screw, Clamp	9545-035-004	1
5	Actuator, Rod	9008-009-001	1
6	Bracket, Overtemp Thermostat	9029-136-001	1
7	Screw, Bracket	9545-008-024	2
8	Spacer, Thermostat	9538-157-003	2
9	Thermostat, Overtemp (resetable)	9576-207-008	1
10	Screw, Thermostat	9545-045-008	2
11	Clamp (Thermostat to Actuator)	9079-121-002	1
12	Screw (Clamp thermostat to Actuator)	9545-035-004	1







# Wiring Diagram for 50hz Dryer -27FL

9506-186-001A

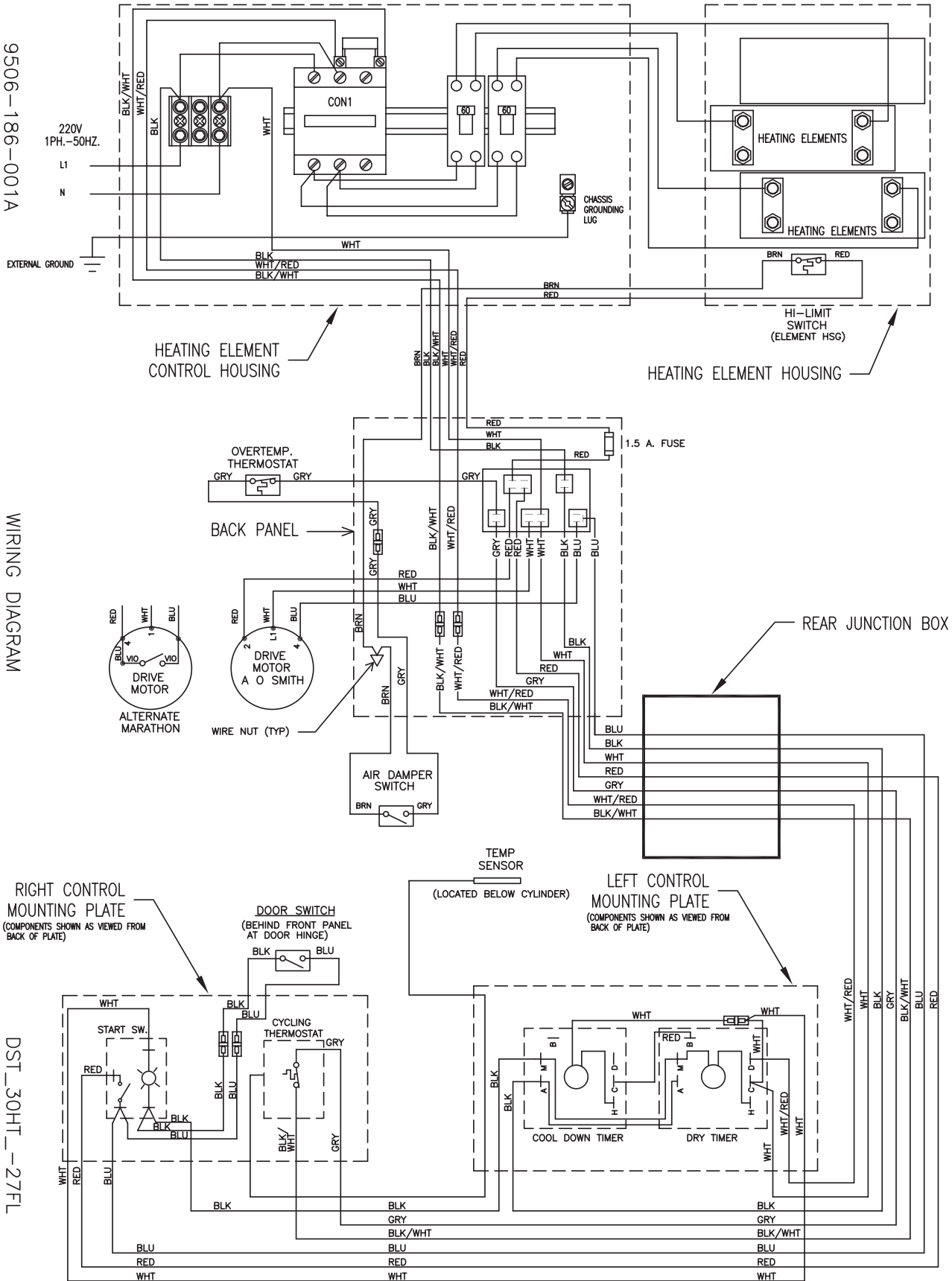

WIRING DIAGRAM

DST\_30HT\_-27FL



# Wiring Diagram for 50hz Dryer -29FN

9506-349-001A

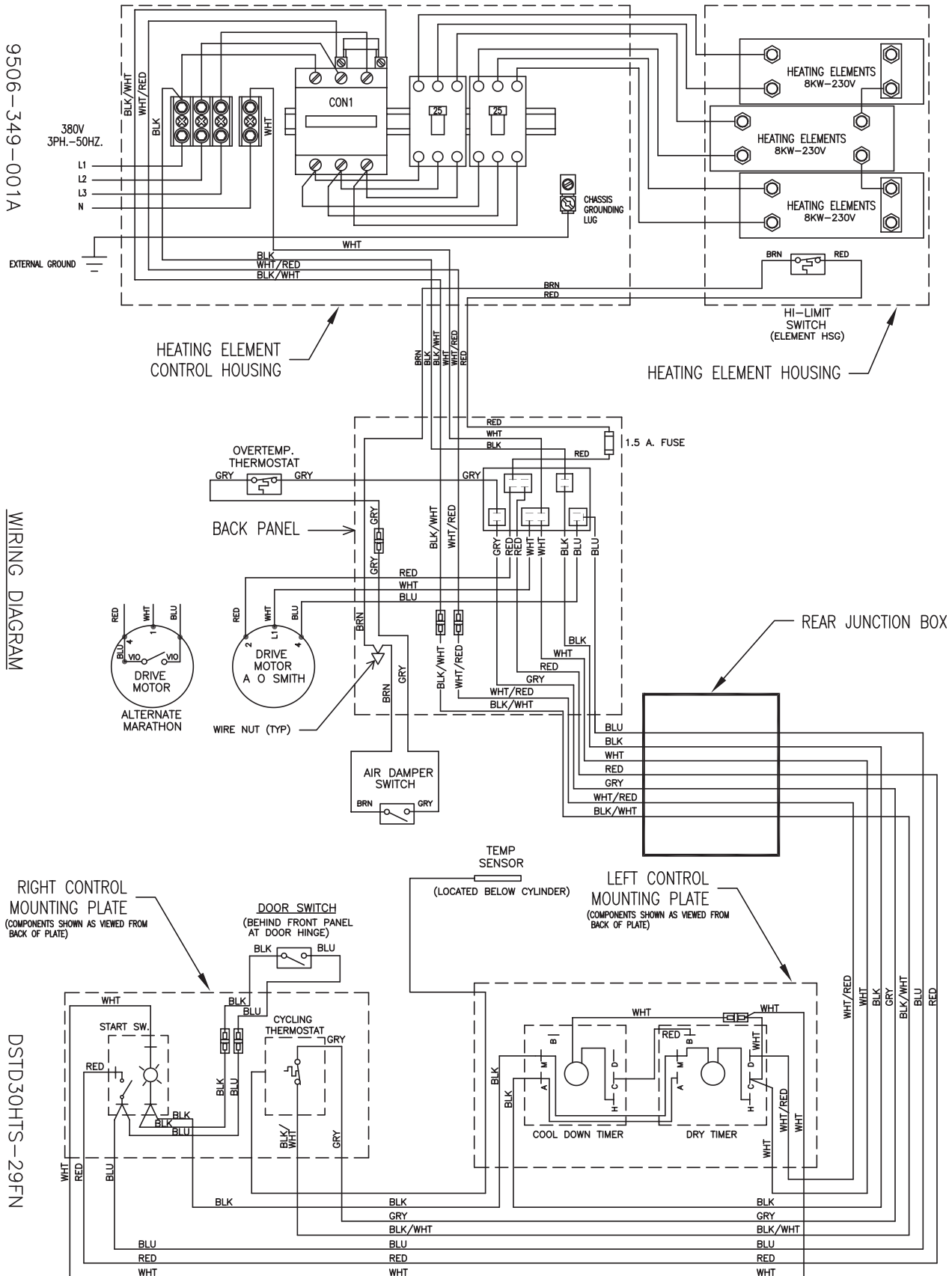

WIRING DIAGRAM

DSTD30HTS-29FN



---

# **Section 9:**

Washer

Service and

Troubleshooting

---

## Front Panel Removal

- Step 1:** Remove the screws from front panel.
- Step 2:** Remove the harness connections from the control boards on the back of the front panel
- Step 3:** pull back the front panel and set it aside.

## Back Panel Removal

- Step 1:** Remove all screws holding back panel in position except the bottom row.
- Step 2:** The bottom row of screws are slotted and only need to be loosened and to lift off panel.

**NOTE:** The back panel is not only a safety requirement but also contributes to the rigidity of the cabinet.

## Drain Valve Access

For access to drain valve, remove the front panel. The drain valve is a ball type and is powered closed by the drain valve motor. It is mounted under the washer tub on the left side. It is spring loaded open. If power is interrupted to the washer, the motor releases the sealing ball, allowing the drive spring to open the valve. With the valve open, all water in the washer will drain out.

## Drain Valve Cleaning

- Step 1:** Loosen the clamp on the tub hose at the drain valve end and remove the hose from the drain valve.
- Step 2:** Loosen the drain hose clamp on the back of the drain valve. Remove two drain valve mounting racket screws from the frame of the washer.
- Step 3:** **Disconnect Brown/Yellow & Blue wire connection at clear connector.**
- Step 4:** Remove the drain valve and bracket assembly. Unplug the wiring after the drain valve is removed from the washer.

## Masking Ring (door lock cover) Removal

- Step 1:** Remove front panel.
- Step 2:** Remove 4 nuts (3/8" socket) that retain masking ring.
- Step 3:** Move it to the left and off.

## Detergent Dispenser

The detergent dispenser is located at the top of the front panel. it is fed water from the vacuum breaker assembly at the rear of the machine to flush the soap with hot water during the wash bath and the fabric softener with cold water during the rinse bath.

## Vacuum Breaker (also called an air gap)

In the left rear of the cabinet is the vacuum breaker. It guides the water to the tub and dispenser and prevents a back flow of water.

## Water Valves

Remove panel to access water valves at rear. The two dual outlet water valves are mounted to this plate. Always check inlet screens to be sure that they are clean. Disassembly of valve requires the removal of two solenoid screws and three valve body screws. Inside the solenoid coil is a solenoid guide, armature, armature spring and diaphragm. All valve parts are available individually or as a complete unit.

## Door Locking Solenoid

The door locking solenoid is powered shut with control voltage to lock the door and releases when voltage is removed. It is located in the left front corner of the washer.

## Thermoactuators

The thermoactuators are a safety device that keeps the door from immediately unlocking if power is lost while the machine is operating. They are mounted under the door locking solenoid.

## Lock Thermoactuator

Control voltage is applied to the lock thermoactuator at the beginning of the cycle making it extend and block the door locking solenoid. This keeps the door locked for approximately two minutes after a power failure occurs. The lock thermoactuator does not delay the door opening at the end of a normal cycle.

## Unlock Thermoactuator

To insure that the lock thermoactuator has retracted by the end of the cycle, one minute prior to the end of the cycle, the unlock thermoactuator is powered with control voltage making it extend and unblock the door locking solenoid.

## Drive Belt Removal

Turn the drive belt(s) off the basket pulley first and then remove from the motor pulley.

**Reverse this procedure for installation.**

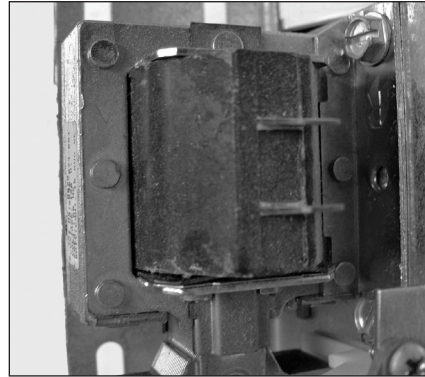

**Door Lock Solenoid**

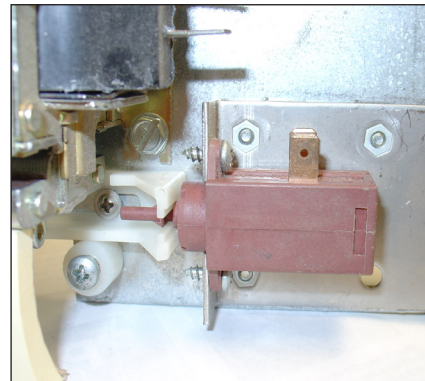

**Thermoactuator**



**Drive Belt**

## Door Lock Assembly Operation

After loading the clothing, the door should be closed and latched. The locking cam on the door contacts the latching switch actuator which closes the latching switch. The specified number of coins should now be added to start the washer. The solenoid pulls up on the locking pawl by use of a linkage rod. The locking pawl has two jobs. The first is to lock the door. This is accomplished by blocking the locking cam on the door so that it can't rotate to unlock. The second job is to close the two piggyback lock sensing switches. These switches control power to all of the controls. If the door unlocks for any reason, these two switches will stop the machine. When the door handle is 1/4 to 1/2 of an inch from its fully closed position, the latching switch should close. The two piggyback lock sensing switches should be open when the door is unlocked and should be closed when the door is locked.

## Accessing the Door Lock Assembly

After removing the front panel and masking ring, the door lock assembly can now be accessed.

## Adjustment for Door Lock Assembly

The latching switch and the piggyback lock sensing switches all have slotted mounting for easy adjustment.

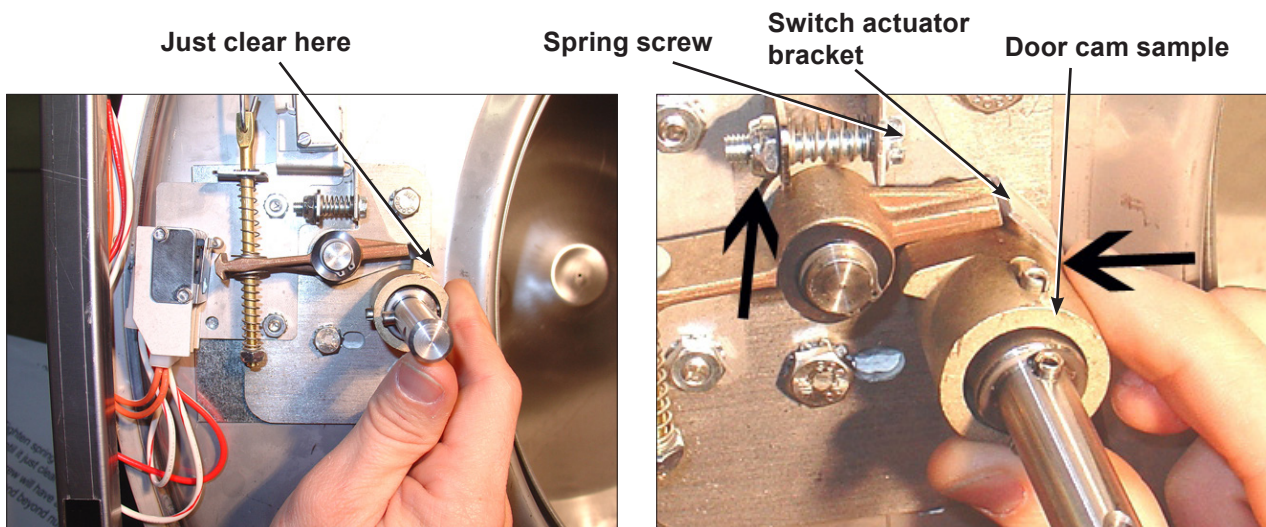

**Step 1:** Set door cam over pin. Here you can see the door cam away from the door lock assembly.

**Step 2:** Tighten spring screw on switch actuator bracket arm until it just clears cam OD. at base of door lock assembly.

**Adjustment to this bracket usually is not necessary as next step is used more in field.**

Flat blade screw on door switch latching

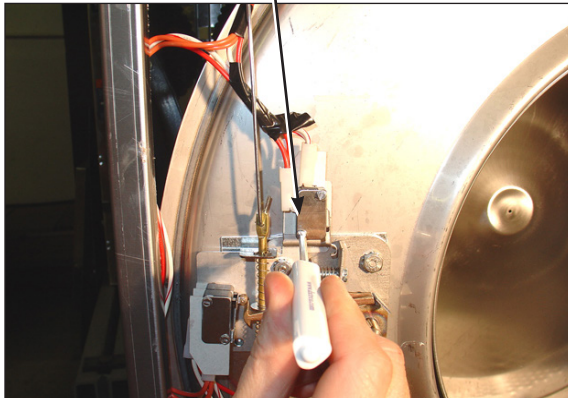

**Step 3:** With switch actuator bracket adjusted you will now need to adjust single switch by loosening 2 flat blade screws and allowing swivel of switch. Move switch towards above bracket until it actuates. Now tighten flat blade screws. Use a .040 thickness gauge to insert between bracket and switch and the switch should close and open again upon removal of thickness gauge.

Door cam check position

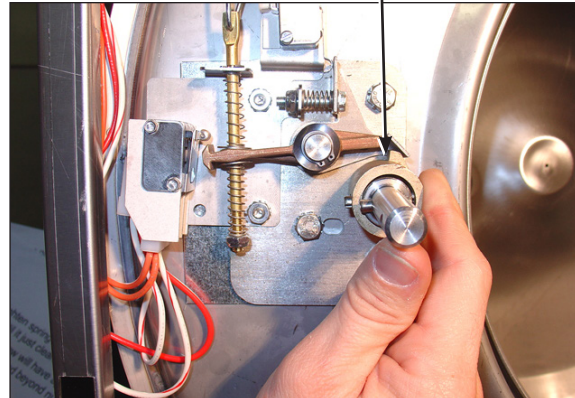

**Step 4:** Check for switch actuation at partial turn of cam as in operation above. Door handle goes from horizontal to six o'clock vertical.

Door lock rod      Locking pawl blocking

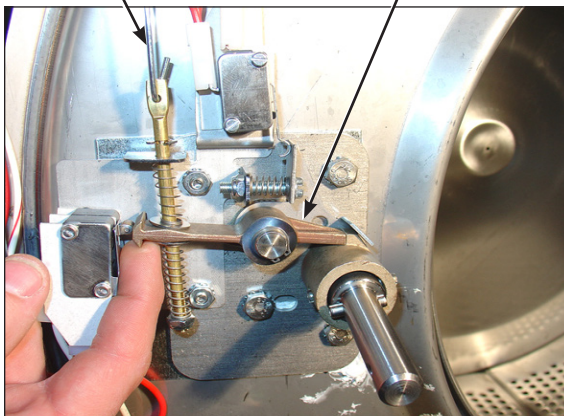

**Step 5:** Check that lock pawl arm swings to cam lobe to lock position.

Adjustment screw for (piggyback switches)      Top of flat end of locking pawl.

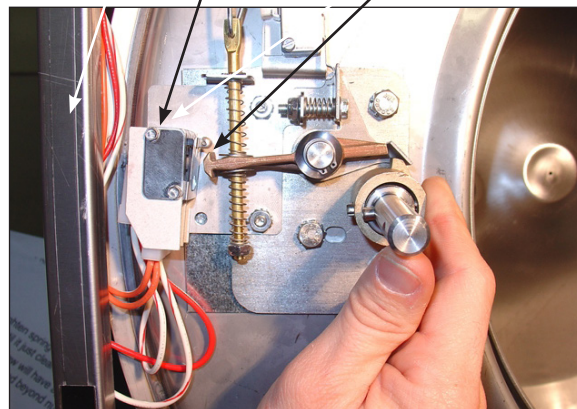

**Step 6:** The lock stacked switches (piggyback) must be adjusted as door lock solenoid pulls up on door rod and locking pawl is now blocking door cam from turning and is in full up position. The stacked switches (piggyback) have a single actuator arm and it must actuate when single actuator roller wheel rolls to flat side of locking pawl. You will also notice a .040 gap between actuator arm and switch bodies.

**Note: Both stacked switches must operate together!**

---

## Adjusting the Loading Door

The door can be adjusted by changing the number of shims behind the door hinge and the door lock assembly. The vertical fit of the door to the tub can be altered by loosening the door hinge bolts and raising or lowering the door before retightening. It is important for the door to be centered on the tub front. By chalking the front of the tub and closing the door to transfer that line to the gasket, the centering can be evaluated. It is also important for door pressure to be similar around the door perimeter. Door pressure can be evaluated by inserting a dollar bill in several positions and tugging on it. See Parts Section for kit to increase door sealing pressure.

### Loading Door Removal



**Step 1:** Support door to prevent dropping.



**Step 2:** Remove 3 bolts holding hinge retainer clamp and set door off.

#### NOTE:

**Door hinge mounting bolts penetrate tub front and require silicone sealer applied to holes when reinstalling.**

### Loading Door Disassembly

**Step 1:** Remove the loading door as outlined above. Lay the door on a flat surface with the glass down.

**Step 2:** While holding down on the door glass, lift up on the door ring and roll back the lip of the gasket with your fingers.

**Step 3:** Work all the way around the gasket and the glass is out.

### Loading Door Hinge Removal

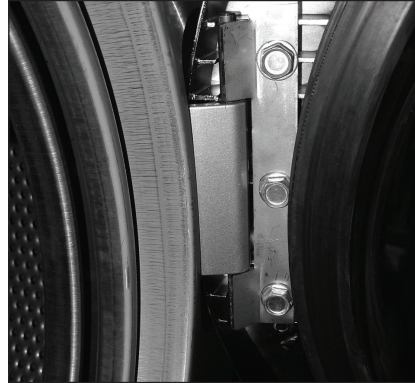

**Step 1:** First remove loading door, front panel, and trim ring.



**Step 2:** Remove 3 screws holding door hinge. Shims may be present between hinge and tub front. The number may be increased or decreased to adjust right side door pressure.

---

## Loading Door Reassembly

**Step 1:** Lay the door ring face down on a flat surface. Start the glass into one side of the door gasket.

**Step 2:** Use one hand underneath to push the gasket out and the other hand on the top pulling the gasket in place.

**Step 3:** The front lip of the door gasket should be checked for proper seating.

## Control Panel Name Plate Decal

The name plate on washer front is adhesive backed.

## Control Panel Name Plate Removal

The name plate may be removed by simply peeling it off.

## Re-Installation of Name Plate

**Step 1:** Remove any remaining glue from the control panel.

**Step 2:** Before removing the paper backing from the name plate, check fit to the control panel. The program push buttons are the locating guides.

**Step 3:** Remove the paper backing from the right side of the name plate, position it on the panel and press right end into place. Peel the backing from the left end and press into place.

---

## Tub Back, Bearing, Cylinder Assembly

### Removing the Washer Tub Assembly from the Washer Frame

**Step 1:** Remove the left and right lower front panel screws that retain the panel to the chassis.

**Step 2:** Remove the Drain Hose from the bottom of tub assembly.

**Step 3:** Remove Overflow and Tub vent hoses at rear tub back.

**Step 4:** Remove the pressure switch hose from the bottom of the switch.

**Step 5:** Disconnect the door lock wires from all switches and the door lock solenoid. The following illustration of their locations should be consulted.

**Step 6:** Disconnect pull rod between solenoid and door lock assembly.

**Step 7:** Disconnect the wires to the drain valve at the bottom of the machine.

**Step 8:** Remove 4 (four) bolts at outer tub and slide complete assembly out front . (Note: very heavy, use appropriate devices )

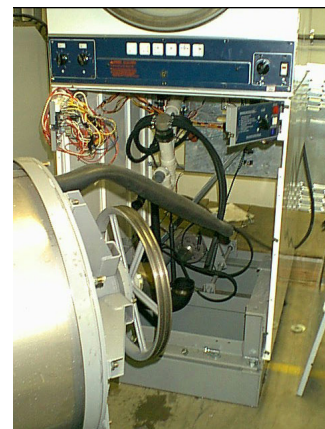

## Tub Back, Bearing, Cylinder Assembly

### Removal

- Step 1:** Remove the tub and cylinder as described previously
- Step 2:** Remove the overflow hose, tub fill hose and pressure switch hose from the back of the tub.
- Step 3:** Mark the tub back and bearing assembly for ease in assembly later. (see picture)
- Step 4:** Remove the 12 bolts and nuts from the perimeter of the tub back clamp ring. (Two of the twelve bolts are longer and go through the thicker part of the brace where it connects to the frame.)
- Step 5:** Remove the 2 bolts that fasten the clamp ring to the frame.
- Step 6:** The entire tub back and cylinder assembly may be lifted out of the tub (it may be necessary to break the adhesion of the silicone that seals the tub back to the tub). Blocks should be placed under the edges of the cylinder before setting it down to prevent damage to the cylinder flange.

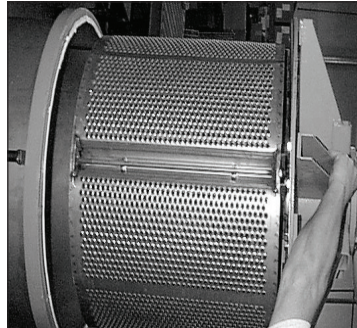

### Reassembly

Reverse the procedures to the left paying attention to the following areas

- Step 1:** Lay the tub and cylinder on its front. Note: Put a thick pad across the front of the washer, above the door, to protect the tub front
- Step 2:** Make sure the bearing housing weep holes are located at 12 o'clock and 6 o'clock.
- Step 3:** Clean the silicone rubber from the back of the outer tub and the perimeter of the tub back where the two meet. There is no gasket in this area.
- Step 4:** Apply a new bead of silicone rubber around the back of the outer tub. (see picture)
- Step 5:** Lower the tub back, bearing and cylinder assembly into the washer outer tub.
- Step 6:** Torque all bolts according to the following charts.
- Step 7:** Use a puller to remove the pulley from the shaft.

---

## Basket Pulley, Bearing Housing, Water Seals and Tub Back

The cast iron basket pulley is retained by a bolt, locking washer and a flat washer.

### Removal

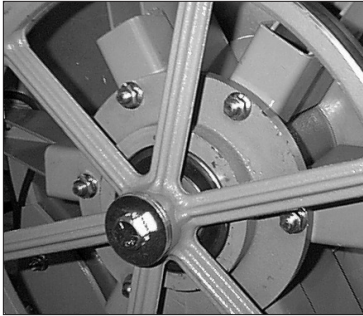

- Step 1:** Insert a large screw driver or punch through a spoke in the pulley into the bearing housing support. This keeps the pulley from turning.
- Step 2:** Remove the retaining bolt, lockwasher and flat washer and reinstall just the bolt
- Step 3:** Use a puller to remove the pulley from the shaft. Watch for tolerance ring.

---

### Reassembly

- Step 1:** Make sure that the tolerance ring is in place inside the pulley.
- Step 2:** The shoulder inside the pulley that holds the tolerance ring should face the back of the washer when installed correctly.
- Step 3:** Use a stack of flat washers and a longer bolt to press the pulley onto the basket shaft.
- Step 4:** Reinstall the retaining bolt, lock washer and flat washer. The shaft end bolt with washer should be installed with a torque value listed in charts in this manual.

---

### Removal of Bearing Housing From Basket Shaft, Bearings and Water Seals



- Step 1:** To remove the tub back assembly, the 6 bolts attaching it to the bearing housing must be removed.
- Step 2:** Remove water seals from the seal mounting plate on the cylinder shaft. These are removed with your fingers.
- Step 3:** The retaining ring next to the front bearing must also be removed.
- Step 4:** The bearings are pressed into the housing and must be pressed back out.

---

### Reinstallation onto Basket Shaft

- Step 1:** Carefully set the assembly over the shaft engaging the bearings and bearing spacer.
- Step 2:** The tolerance ring that fits inside the pulley should be placed in position (see Basket Pulley Reassembly for correct positioning).
- Step 3:** The pulley should then be started onto the shaft. A stack of flat washers and a longer pulley bolt will be required to pull the basket shaft through the bearings and pulley.
- Step 4:** Install the shaft end bolt with washers and torque to specifications in Bolt Torque Chart.
- Step 5:** See Tub Back, Bearing and Cylinder Assembly for installation of complete assembly back into washer.

## Reassembly

**Step 1:** When installing new bearings into a bearing housing, first press the front (large) bearing into the housing until it bottoms. With the bearing spacer in place, press the rear bearing in until the spacer is snug between the two bearings. Be sure and reinstall the retaining ring in front of the front bearing (see picture).

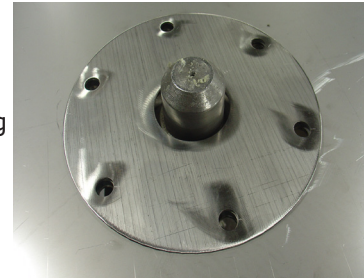

**Step 2:** The tub back assembly should be reattached to the bearing housing with the 6 mounting bolts and torqued according to the torque chart.  
**Note: The bead of silicone that seals each bolt to the tub back. This must be cleaned and replaced upon reassembly (see picture).**

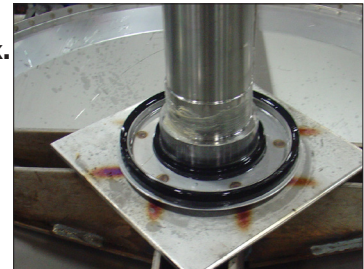

If the 6 support assemblies have been removed from the bearing housing, the 6 rear bearing housing bolts should be torqued according to the chart also.

**Step 3:** The primary and secondary seals that mount on the sealing ring may be slid over the shaft and seated on the metal sealing ring. In the unlikely event that the metal ring that mounts these sealing rings were to be damaged or moved, a new one would need to be pressed on. The ring must be pushed against the stop on the shaft. Before installing the new sealing ring, a bead of silicone should be put on the basket shaft (see picture). After installing the seals, lubricate the faces of the seals with silicone grease (see picture).

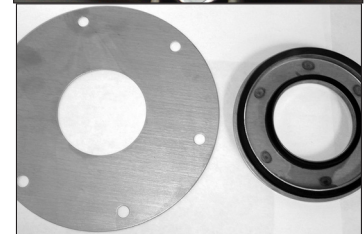

## Removal

**Step 1:** Remove the drive belt as explained in previous instructions.

**Step 2:** Remove the tension spring and bracket.

**Step 3:** Disconnect the motor wires in the control area at the top of the machine. The motor wire retaining clamp should be removed and reused. There is a diagram showing where each motor wire plugs in so there is no need to mark them.

**Step 4:** Loosen the set screws on the motor support shaft.

**Step 5:** Remove the retaining bolt from the front of the support shaft.

**Step 6:** Remove the motor support shaft.

**Step 7:** Lift motor out of machine. Note: On larger washers it is advisable to put a board under the motor and slide it out rather than lifting it.

## Bolt Torque Chart

Bolt Size	Where Used	Torque
1/2"x 1 1/4" bolt	Tub End of Bearing Hsing. 9545-017-009	70-110 ft/lbs
5/8"x 1 1/2" bolt	Tub End of Bearing Hsing. 9545-060-001	120-150 ft/lbs
1/2"x 1 1/4" bolt	Mtg. of Tub to Cradle Asy. 9545-017-009	70-110 ft/lbs
5/8"x 2 1/2" bolt	Mtg. of Tub to Cradle Asy. 9545-060-001	120-150 ft/lbs
3/8"x 1 1/2" bolt	Tub Back Ring to Tub Back 9545-029-003	45-80 ft/lbs

---

## Control Mounting Trough

Remove rear panel to access control trough. It sets on the right side of the machine and holds the control PCB's, transformers, and pressure switch.

## Main Data Communication Cable

Goes between front PCB board and Variable Frequency Drive unit mounted center rear of machine. It has telephone type connectors at each end and is inserted at Controller PCB and the Variable Frequency Drive.

## Circuit Breaker/Fuse

The fuse (optional circuit breaker) mounts to the rear channel. It carries all of the controls in the machine but does not include the motor. To reset the circuit breaker just push in the button. If you have a fuse then remove fuseholder and fuse and replace with a 1 1/2 amp fast blow type fuse.

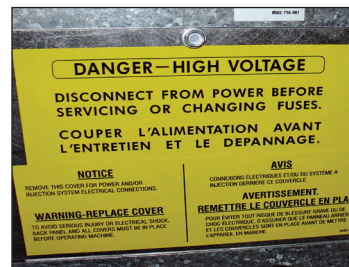

Fuse Location

## Main Control Printed Circuit Board

Please be sure to be grounded to machine before removal of this board from machine. PC board mounted vertically behind front control panel. Remove hold down nuts in 4 corners and 1 at bottom center.

## PCB Transformer Step-down

Small transformer mounted at front of control trough that is powered with 120 VAC primary and two secondary outputs of 2.3 VAC and 24-27 VAC.

## Controls Transformer

This transformer is mounted at the back of the control trough and steps a range of 208 to 240 volts down to 120 volts for the controls. There are two terminals on the controls transformer for incoming power. One terminal tap is marked for 208 volts use this tap for measured voltage of 200 volts - 215 volts. and the other tap is marked 230 volts for 216 volts - 240 volts. Note: All washers have a controls transformer. Always check the incoming voltage and use the appropriate transformer terminal when installing ALL washers.

## Main Relay Printed Circuit Board

Please be sure to be grounded to machine before removal of this board. PCB mounting horizontal in control trough towards front of machine. Remove 4 mounting nuts.

## LED Printed Circuit Board Temperature & Start Display/Push-Button

The selector switch is mounted in the center of the control panel and is held in place with five nuts. It allows the selection of hot, warm or cold water temperatures. Note: Do not over tighten on reinstallation as the switch can be damaged, stay pushed in and will cause erratic displays.

## Add-Bleach LED

This LED light indicates to the user the correct time to add bleach. This LED is polarity sensitive and must be connected correctly.

## Pressure Switch Caution (Not recommended by Factory!) Changing Factory preset adjustment voids all factory water usage specifications.

The pressure switch sets the water level in the washer. As the water level rises, it compresses the air in the pressure switch hose. When the washer reaches the desired water level, the compressed air in the pressure switch hose opens the contacts in the switch, shutting off the water. When at the empty level, the pressure switch contacts are closed allowing the machine to either spin or fill with water. The 1/4" screw in the middle of the switch adjusts the water level. Counter clockwise will lower the water level, and clockwise will increase the water level. Before making any adjustments of the pressure switch, drain the tub and blow the hose clear of possible water bubbles which can cause erratic pressure switch operation.

SINGLE LEVEL

DUAL LEVEL

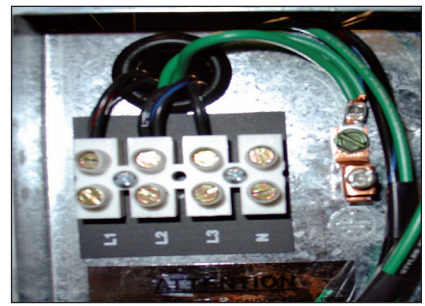
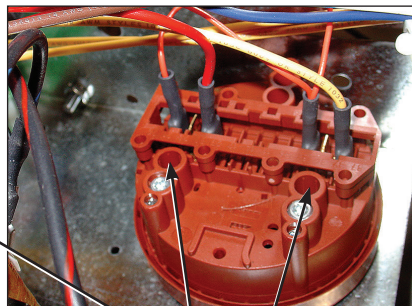
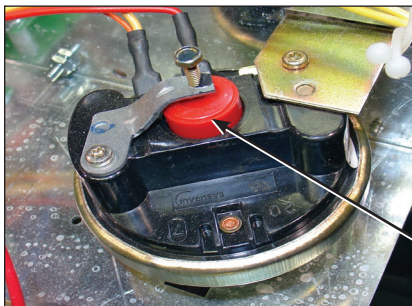

Pressure Switch

Adjustment

Rear

## Mechanical Pressure switch VS Pressure Sensor

The Drawing below represents the Mechanical Pressure switch and wiring connections. After serial number W1.15244.001 all washers were converted to the electronic pressure sensor 9732-315-001. If desired previous C-series machines can be upgraded to the electronic pressure sensor with Kit 9732-314-001, Kit includes pressure sensor, hold downs, transformer, and wires. The Electronic pressure sensor wiring configuration is represented in the Diagrams and Schematics in this manual.

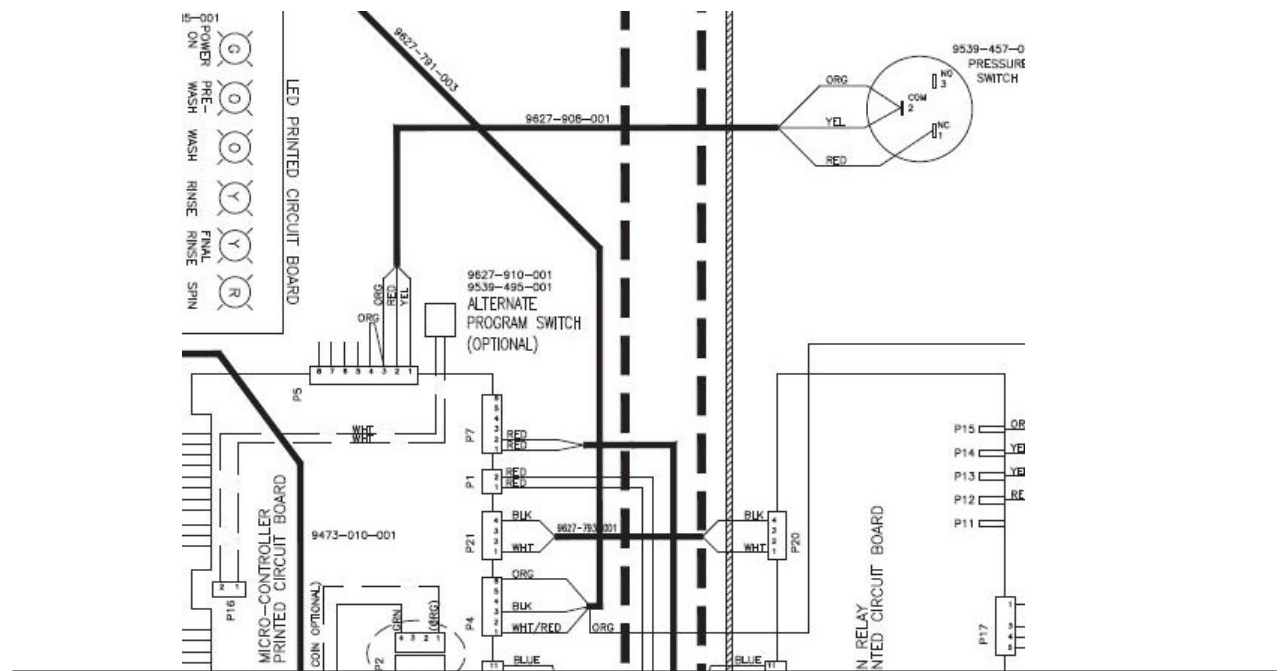

## Electronic Pressure Sensor

The Electronic Pressure Sensor comes standard on all models Starting Septembet, 1st 2015. Machines manufactured before this date can be upgraded with Kit 9732-213-001. The Pressure sensor is adjustable. The Factory settings chart will let you know the starting values for each machine and by following the Switch position chart you can adjust the water levels in 1/4 inch increments from that starting value.

### Factory Settings:

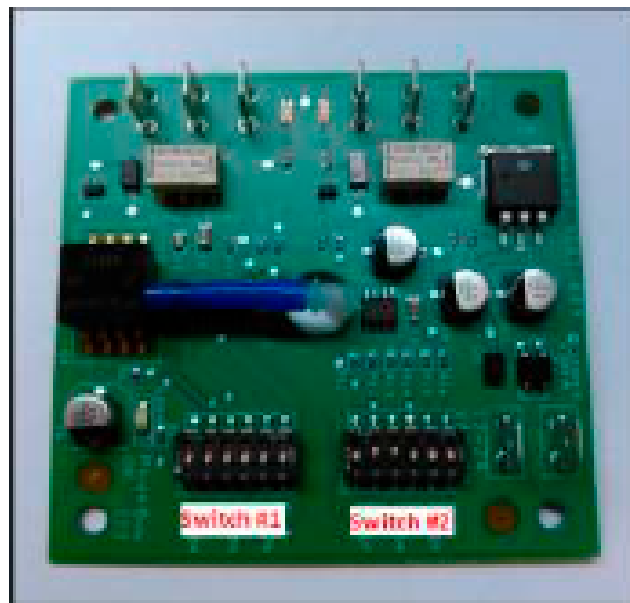

Model	Vended		On-Premise	
	Switch #1 Efficient	Switch #2 Classic	Switch #1 Low Level	Switch #2 High Level
T-300	5.25	7.00	8.00	8.75
T-350	5.25	8.25	8.00	8.75
T-400	7.00	9.00	8.00	11.00
T-450	6.00	8.25	8.00	8.50
T-450 SWD	5.00	7.00	8.00	8.50
T-500	7.25	9.25	8.00	11.00
T-550	6.50	8.25	8.00	11.00
T-750	6.00	7.50	8.00	8.75
T-800	6.00	7.50	8.00	8.75
T-850	6.00	7.50	8.00	8.75
T-1200	6.00	7.50	8.00	8.75
T-1450	6.75	7.00	8.75	9.50

### Switch Positions:

Depth (ft):	Pos 1	Pos 2	Pos 3	Pos 4	Pos 5	Pos 6
<b>5.00</b>						
5.25	on					
<b>5.50</b>		on				
5.75	on	on				
<b>6.00</b>			on			
6.25	on		on			
<b>6.50</b>		on	on			
6.75	on	on	on			
<b>7.00</b>				on		
7.25	on			on		
<b>7.50</b>		on		on		
7.75	on	on		on		
<b>8.00</b>			on	on		
8.25	on		on	on		
<b>8.50</b>		on	on	on		
8.75	on	on	on	on		
<b>9.00</b>					on	
9.25	on				on	
<b>9.50</b>		on			on	
9.75	on	on			on	
<b>10.00</b>			on		on	
10.25	on		on		on	
<b>10.50</b>		on	on		on	
10.75	on	on	on		on	
<b>11.00</b>				on	on	
11.25	on			on	on	
<b>11.50</b>		on		on	on	
11.75	on	on		on	on	
<b>12.00</b>			on	on	on	
12.25	on		on	on	on	
<b>12.50</b>		on	on	on	on	
12.75	on	on	on	on	on	
<b>13.00</b>						on
13.25	on					on
<b>13.50</b>		on				on
13.75	on	on				on
<b>14.00</b>			on			on
14.25	on		on			on
<b>14.50</b>		on	on			on
14.75	on	on	on			on
<b>15.00</b>				on		on

---

## **Power Connection Terminal Block**

This terminal block sets at the very back of the control trough. Incoming power to the washer should connect here. (see Electrical under Installation and Operation Section for exact connections)

## **Delta Variable Frequency Drive:**

Main power is connected to terminals L1, L2, and L3 on the Delta drive. If the washer is connected to a three phase source, there should be voltage present on all three terminals. If the washer is connected to single phase power, there should be voltage present on terminals.

The voltage should measure 208 Volts to 240 Volts A.C. between phases and connected to if connected to three phase). There is a tolerance of + 10% on the mains voltage (187 Volts to 264 Volts).

## **Delta VFD Motor Leads:**

The wires from the motor are connected to terminals T1, T2, and T3. Since this drive uses pulse width modulation, an accurate current or voltage reading is not possible. Although an accurate current reading is not possible, a balanced current reading should be present while the motor is running.

## **Delta VFD Dynamic Braking Resistors:**

Three 200 Ohm braking resistors are connected in parallel and attached to the drive at terminals B1 and B2. These resistors allow voltage, which is generated by the motor when decelerating, to be dissipated. They will become hot while the motor is slowing down, so care should be taken so as not to come in contact with them. This will prevent an electrical shock and/or a physical burn.

## **Delta VFD Cooling Fan:**

There is a cooling fan attached to the bottom of the Delta drive. This fan will operate when the internal temperature of the drive reaches a predetermined level, the same way the radiator fan in a newer car operates. THE FAN CAN OPERATE ANYTIME POWER IS APPLIED TO THE DRIVE! Remove power to the drive if work is required around the fan.

# Common Washer Troubleshooting Solutions

Symptom	Probable Cause	Suggested Remedy
Machine does not start	Power Supply	Check these areas: Circuit breakers, Voltage, Power leads, Power connections. Is front display LED showing a dollar amount.
	Door Switch	Check for continuity through door switch when door is closed. If no continuity, adjust or replace door switch.
	Control Breaker or Fuse	Check 1.5 amp (T-1200. uses 2.5amp) breaker or fuse for continuity. If no continuity, replace breaker or fuse.
	Control Transformer	Check voltage output from control transformer for 120VAC. If voltage is incorrect, replace transformer.
	Check PCB board	Check all wire connections for sure contacts.
	Check wiring between PCB	Check data cable phone type connectors unplug and VFD and replug with power removed.
	Check Relay PCB	Check all wire connections for sure contact.
	Check Door Solenoid	Check that 120 v power is at solenoid after start button is pushed.
Door does not lock	Check display for fault code	Does F1 show on the front of display. If yes follow tests described in fault code section.
	Door locking solenoid	Check to insure that solenoid is receiving 120VAC from main relay PCB. If it is, replace solenoid.
	Door Switch	Check for continuity through door latch switch when door closed. If no continuity, adjust or replace door switch.
Door will not open	Thermoactuator	Check to see if thermoactuator(s) and/or its mechanism is stuck or binding and not allowing the door lock solenoid to open. Check to be sure that the locking thermoactuator is not receiving 120VAC during the last 1 1/2 minutes of the cycle. Also check to see that the unlocking thermoactuator is receiving 120VAC during the last minute of the cycle. If the thermoactuators do not receive voltage at the correct times, change the timer. If the timing and voltage are correct, replace the thermoactuator.
Door will not open	Door Rod	Check to see that door rod from solenoid to lock ass'y is long enough to allow lock ass'y to disengage. If not, adjust rod.
	Door Lock Solenoid	Check that door lock solenoid is not stuck closed. If stuck, replace solenoid.
No hot water in detergent dispenser	Water Valve Coil	Check coil continuity at terminals and replace if no continuity. 120 V power only on for 20 second in wash bath.
	Water Inlet	Check water inlet screens for blockage and clean screens if necessary.
	Water	Check to insure that water is turned on and operating.
	P-20 Wire Harness	Check black & white harness.

Symptom	Probable Cause	Suggested Remedy
Hot water does not enter tub in wash	Water Valve Coil	Check coil continuity at terminals and replace if no continuity. Check for 120 V power from main relay PCB
	Water Inlet	Check water inlet screens for blockage and clean if necessary screens
	Water	Check to insure that water is turned on and operating.
	Blk or Wht wire at main controller	Check black or white wires at Molex plug on PCB at main controller and at relay PCB.
	Pressure Switch	Check pressure switch continuity between terminals . If no continuity, check pressure switch hose for obstruction. If hose okay, change pressure switch.
No cold water to tub in wash	Water Valve Coil	Check coil continuity at terminals and replace if no continuity.
	Water Inlet Screens	Check water inlet screens for blockage and clean if necessary.
	Water	Check to insure that water is turned on and operating.
	Blk or whit wire at controller and main relay PCB	Check black or white wires at Molex plug on PCB at main controller and at relay PCB.
	Pressure Switch	Check pressure switch continuity between terminal contacts. If no continuity, check pressure switch hose for obstruction. If hose okay, change pressure switch.
Water comes in but level does not rise	Drain Valve (open)	Check these areas • Drain valve blockage • Drain valve motor and gear train. If power but drain valve does not close, replace valve. • Power to the drain valve. If no power to drain valve, check (brn/yel) circuit for power.
	Blk or whit wire at controller	Check black and white wires at molex plug on main PCB controller and at main relay PCB
Water does not flush softener compartment.	Water Valve Coil	Check coil continuity at terminals and replace if no continuity.
	Water Inlet Screens	Check water inlet screens for blockage and clean if necessary.
	Water	Check to insure that water is turned on and operating.
Water does not flush softener compartment.	Pressure Switch	Check pressure switch continuity between terminals. If no continuity, check pressure switch hose for obstruction. If hose okay, change pressure switch.
Water level too high	Pressure Switch	Check for blockage in pressure switch hose. Check for pressure switch opening circuit across terminals . Replace switch if contacts do not open.
Water drains slowly	Drain System	Check hoses and drain valve for blockage. Clean of inadequate size. if necessary. Check building drains for blockage

# Common Washer Troubleshooting Solutions

Symptom	Probable Cause	Suggested Remedy
Machine does not turn	VFD	Check VFD by removing inspection panel and record any numbers or letters displayed. If no display turn power off to machine at breaker for 2 minutes and turn power back on to reset. If still no display replace VFD
Machine tumbles in one direction	VFD	Remove inspection cover at rear and record in only numbers or letters displayed. See fault code section for more info.
	VFD	Inspect yellow enable wires from main relay PCB and at VFD
Excessive vibration	Mounting System	Check these areas: • Strength of mounting structure, concrete or base. • Mounting bolts may be loose and need tightening.
	Drive Belt	Worn drive belt can cause vibration and noise.
	Loading	Note: Small loads contribute to out of balance loading and increase vibration.
Machine does not spin	Pressure Switch	Check pressure switch for continuity across terminals #21 & #22 indicating pressure switch has reset to the empty position. If no continuity, change pressure switch.
Machine starts and does not operate	VFD	Check yellow enable wires from relay PCB P13 & motor P14 to VFD advances through cycle are connected. Check fault code on VFD before removing power from the drive. Check orange P-15 wire for signal from door switches.
Machine does not stop	Main PCB	Main PCB controls time cycle at end of cycle
	Braking Resistors	Check braking resistors for continuity. Verify ohms resistance by Molex.
Water leakage around loading door	Door Adjustment	Door may need adjustment due to abuse or wear. Check tightness around perimeter using a dollar bill. Adjust left to right tightness by shims at door lock or hinge side. It is important to center gasket to tub opening before tightening door to hinge bolts. Chalk may be used on tub front to show point of contact with tub. If gasket is deformed, worn, or damaged, replace. Refer to parts section for door gasket expander kit.

## Troubleshooting Washer Fault Errors (F-Codes)

The following pages are a description of fault codes that will appear on the front of the washer. There is a chart format that shows what fault code that will be displayed at washer front. These codes displayed may stop machine operation or may not stop machine Please check chart before removing power to reset. PLEASE NOTE: CHECK DRIVE FAULT CODE BEFORE POWERING MACHINE DOWN!

Fault#	Description	Customer Action
<b>F1</b>	The door failed to close and lock or The door failed to remain locked during the cycle.	Check VFD fault code before turning off. Check to hear if door solenoid engaged. Turn off the power to the washer. Check wire connections to door /lock switches. Check wire connections from switches to controller. Check P-4 wire connections at PCB controller. Adjust the door lock mechanism. (See service manual)
<b>F2</b>	The washer tub does not fill with water within 7 minutes. The wash cycle will continue. The F 2 will flash three times, then wait for 30 seconds. The error will clear at the end of the cycle.	Turn off the power to the washer. Check the operation of the water valves. Check the incoming water pressure. Check for blocked or restricted water flow. Check to ensure the drain valve is functioning properly. This error will occur on 18# washers when water level is set for high (the pressure switch in 18# washer is only one level).
<b>F3</b>	Memory error in controller. The memory checksum is wrong.	Check VFD fault code before turning off power. Try to clear the fault with the Palm. Try a soft Reset of the controller with the white button. If problem. Replace PCB controller.
<b>F4</b>	Washer controller communication error	Check VFD fault code before turning off power. Try the data cable first. Move around cable and remove any side loading tension from data cable connector ends. Check connection P25/24/23 to P15. Turn power back on to the washer. If the problem returns, replace the PCB washer controller.
<b>F5</b>	Pressure Switch error (only OPL) - when the high level sensor indicates full but the lower one indicates empty. The wash cycle will continue. The F 5 will flash three times, then wait for 30 seconds. The error will clear at the end of the cycle.	Check VFD fault code before turning off power. Check the pressure switch.(Ohm out contacts). Check pressure switch connections to ensure they are all making good contact. Check the Molex type harness connector to ensure no wire been pushed out of the Molex type housing that it is shorting or not connecting.
<b>F6</b>	Wrong washer size for drive type.	Check VFD fault code before turning off power. If the controller was installed in a different size machine before being installed in this machine, a problem can occur. If someone has been doing repairs on the washer, check for the correct size drive. It can also be caused by pressure switch harness. Check to ensure the correct harness in installed. The control can be reset by holding program button on controller during startup (soft reset). Check orange wire at Molex connector on controller coming from pressure switch or replace pressure switch harness.

Fault#	Description	Customer Action
F7	Wrong size drive installed	Check VFD fault code before turning off power. Check to ensure all the harnesses are properly connected to the controller. Check to ensure the VFD drive horsepower is proper for this size of washer. The control can be reset by holding program button on controller during startup (soft reset) Check orange wires at molex connector on controller coming from pressure switch.
F8	The washer tub does not empty within 7 minutes. The wash cycle will continue. The F 8 will flash three times, then wait for 30 seconds. The error will clear at the end of the cycle.	Check VFD fault code before turning off power. Check to ensure the drain valve is operating properly (slow drain has potential to cause this code). Check to ensure the pressure switch tube is clear of any blockage, and the pressure switch is operating properly. Check the pressure switch harness.
F9	The washer tub does not reach the spin target frequency within 150 seconds. The wash cycle will continue. The F9 will flash three times, then wait for 30 seconds. The error will clear at the end of the cycle.	Check VFD fault code before turning off power. Check to ensure the drain valve is operating properly (slow drain has potential to cause this code). Check to ensure the pressure switch tube is clear of any blockage, and the pressure switch is operating properly. Check the pressure switch harness.
F10	After a spin the washer tub does not stop within 150 seconds.	Check VFD fault code before turning off power. Inspect the braking resistors and measure the resistance. Check connecting wiring from braking resistor to the drive mounted in the top of the washer. Reset the drive and try again. Possibly incorrectly programmed drive.
F11	The drive size setting has changed.	Check VFD fault code before turning off power. Check to ensure all the harnesses are properly connected to the controller. Check to ensure the drive horsepower is proper for this size of washer. If no one has worked on machine very recently then PCB controller or VFD may need to be replaced. Do a soft reset before and after either VFD replaced.
F12	Washer controller internal error	Check VFD fault code before turning off power. Turn off the power to the washer. Wait one to two minute. Turn on the power to the washer. If problem reappears, contact your Dexter Authorized Representative.
F13	The variable frequency drive (VFD) and the washer computer are not communicating.	Check the data communication cable between the washer computer and the variable frequency drive (VFD). <b>Step 1:</b> Make sure the cable did not become unplugged during operation. <b>Step 2:</b> Make sure that the cable is not being pulled sideways at either the washer controller, or the VFD, plug end. If both ends of the communications cable are plugged in the washer computer and VFD and there is no tension on the communications cable pulling it from side to side, then replace the cable.\n <b>Step 3:</b> Inspect both female connection points at PCB controller and at VFD. Blow out with compressed air and clean with contact cleaner. These may need replacement if they cannot be reset.

Fault#	Description	Customer Action
F14	Over-current on the drive or motor.	<p><b>Step 1:</b> Check to make sure the washer cylinder turns freely by hand. If it turns freely, continue to step 2. If it does not, remove the belt and see if the motor turns freely by hand. If the motor turns freely, then check for obstructions in the cylinder or check the bearings. If the motor does not turn freely, replace the motor.</p> <p><b>Step 2:</b> Check the motor wires for a short circuit between leads. If there are motor leads that have conductors touching, separate them and insulate them. If the wires are broken, splice them together or replace the motor.</p> <p><b>Step 3:</b> Check braking resistors to see if they measure the correct resistance. If a resistor does not measure the proper value, replace it.</p>
F15	The variable frequency drive (VFD) senses that the internal voltage is too high. The source of the problem can originate from two different areas. Area 1: The input voltage can be too high, or there may be a high level of electrical noise. Area 2: The motor can be generating a voltage that is acting like an input to the VFD output motor terminals.	<p><b>Step 1:</b> Measure the supply voltage to the VFD on the L1, L2 (or N), and L3 (if connected to three phase power). the supply voltage should be from 187 to 264 VAC or 108 to 132 VAC for a 120 VAC VFD. Also make sure the supply wires on L1, L2 (or N) and L3 (if connected to three phase power are securely connected.</p> <p><b>Step 2:</b> Check the braking resistor connections at the VFD. The terminal screws should be tight. Once of the braking resistor wires should be connected to terminal B2.</p> <p><b>Step 3:</b> Measure each braking resistor separately to make sure they are the correct resistance. (200 for 1 and 2 Hp VFD and 160 for 3 Hp VFD).</p> <p><b>Step 4:</b> If you have a 240 VAC, high leg voltage supply, try disconnecting the high leg. If this cures the problem, either leave the high leg disconnected, connect a transient voltage surge suppressor (with some form of filtering) at the voltage supply panel, connect a line choke on the high leg or install a VFD filter.</p>
F16	The temperature sensor inside of the variable frequency drive detects that the internal temperature is too high.	<p><b>Step 1:</b> Make sure the cooling fins on the VFD heatsink and the ventilation louvers on the VFD cooling fan cover are clean. <b>Step 2:</b> Start a washer cycle and make sure the VFD cooling fan operates after the cylinder starts turning.</p>
F17	Overload of the drive or motor	<p>(Check drive fault code before powering down). Check the washer motor to ensure it turns freely. Check the wiring for loose connections to the drive and motor. Measure the braking resistor values. Check for damaged motor wires. Check V-Belt tension and adjust to 1" deflection at center. Check braking resistors.</p>
F18	Ground Fault to the drive	<p>Check VFD fault code before turning off power. Check the wiring connections to the drive and motor. Check the ground wiring of the drive, motor and incoming connection to ensure a proper ground is present. Check for damaged motor wires.</p>

Fault#	Description	Customer Action
F19	Low Voltage to the drive	Check VFD fault code before turning off power. Turn the power off to the washer. Check the wiring connections to the drive and motor. If no problem is observed, turn on power to the washer and test. (See Note) Measure the incoming line voltage.
F20	Internal drive error	Check VFD fault code before turning off power. Turn the power off to the washer. Wait one minute. Turn the power on to the washer. If problem reappears, contact your Dexter representative.
F21	Data error on communications between the controller and drive Internal drive error # 32. This error also has CEXX errors associated with it that are presented on the drive display.	The CE errors are communications errors. Data Cable noise can cause the majority of these errors. Check VFD fault code before turning off power. Check the data cable between the controller and the drive. Replace data cable if it appears damaged and fault appears again. Please note that this fault will occur if you turned main power off and on to quickly. (See Note below)

**Warning codes F22 - F28: These codes indicate that a component (VFD, relay PCB, injection relay PCB, water valve) has been replaced, added, or removed and you will need to soft reset the PCB controller board to reset the main controller to operate properly.**

F22	MS300 Drive Conversion Only	Retighten the screw down connections on the lower terminal bar of the VFD for DC1, B1, and B2. Check the wire connections on B1 and B2 for Breaking Resistors.
F23	VFD has been replaced, disconnected, or removed.	Soft reset control.
F24	Injection relay PCB has been removed or loose connection.	Soft reset control.
F25	Optional water valve PCB removed or water valve has been replaced .	Soft reset control.
F26	VFD unit has been added or loose connection.	Soft reset control.

Fault#	Description	Customer Action
F27	Injection relay PCB has been added to machine or loose connection.	Soft reset control.
F28	Optional water valve PCB has been added or loose connection	Soft reset control.

**Note:** Whenever power is turned off to the washer, it must remain off for three minutes for drive to reset. The washer will not operate correctly if this is done improperly. This will allow most fault codes to reset that are displayed at washer front. A fault code F-13 or F-21 will appear on front display if this procedure has not been reset correctly. Note: Should a power loss occur during cycle and then power returns, P U S H will be displayed and customer must push a temperature selection button to continue the cycle.

# Variable Frequency Drive Control

## Digital Readout Faults

	Description	Customer Action
<b>CE1</b>	VFD received an illegal command. Possible controller problem	Reset drive.
<b>CE2</b>	Illegal data address, VFD received an address not available to the controller.	Reset drive.
<b>CE3</b>	Illegal data value received at VFD. Possible controller problem.	Reset drive.
<b>CE4</b>	VFD unable to perform the requested action. Possible controller problem.	Reset drive.
<b>CE6</b>	Time frame between commands is too short. Possible controller problem.	Reset drive.
<b>CE9</b>	Internal checksum error. VFD problem.	Reset drive.
<b>CE10</b>	Watch dog timer. Command not received from the controller every 6 seconds	Reset drive.
<b>CE11</b>	Frame error. Possible Baud rate issues between VFD and controller	Reset drive.
<b>CE12</b>	Command message is too short. Possible controller problem	Reset drive.
<b>CE13</b>	Command message is too long. Possible controller problem	Reset drive.
<b>CE14</b>	Command message includes unused characters. Possible controller problem.	Reset drive.



---

# **Section 10:**

## Washer Electrical Wiring Diagrams & Schematics

---

# Electrical Path Circuit Schematics

## Start Circuit

Power travels into the machine on L1 & L2 & (L3) ( if 3 phase used). 208- 240VAC goes to a Control Transformer ( must be checked at start -up to coincide with machine operating voltage) that steps the voltage down to 115VAC for the controls. 115VAC then travels from the transformer out on [X-1 red wire to the (fuse)] or [ X-1 blk/red wire] to TB-4 then to the red wire to the fuse, (fuse in fuseholder). X-2 Blk/blu wire is the neutral side of the transformer.

From the Fuse holder, 115VAC travels on the red wire to the #5 terminal on the terminal strip and then on the black wire to the Step-Down Transformer where it is stepped down to 2.3 VAC and 24 VAC that proceeds to the P 7 connection to power the micro-controller PCB. The Door must be closed to satisfy the door closed switch mounted on masking ring at front door. With data going out from front main PCB on the black wire through door closed switch and red wire out of door closed switch and over to door latched switch to await start button being pressed. Main PCB is satisfied and a 5 VDC signal is sent out of P4 connection on the white/red to the S1 door switch. With the S1 door switch closed 5 VDC is now on the red wire at the P4 connector of the micro-controlled PCB and a 115VAC signal will go to the Door Lock Solenoid from the P17 connector of the Main Relay PCB on the white/red wire. The Door Lock Solenoid pulls in, locking the door and closing the S2 and S3 Switches. The S2 Switch is a backup to the S1 Switch so that the adjustment on S1 isn't as critical. The S3 Switch provides 5 VDC on the org. wire back to P4 connector at micro-controlled PCB and P15 connector at the main relay PCB to know the loading door is closed and locked. Org. wire @ P15 turns on the enable to the drive to allow motion. With no signal on P15 (org. wire) there will be no motion of the tub. The black wire and white wire between Front controller PCB P21 and the main relay PCB P 20 is where door lock data is supplied to indicate door closed and locked to relay PCB and allows 120 volts to pass through relays to drain valve and water valves. The blue wire from the terminal strip will provide the 115 VAC neutral for solenoid, thermoactuators and all valves and the white wire from the terminal to the step down transformer.

## Fill Circuit-Warm

S1, S2, and S3 Door Switches are now closed . The green On LED and the Door Lock Solenoid (discussed in Start Circuit) will remain on throughout the cycle. The Lock Thermoactuator receives 115VAC on orange/blue from P17 on main relay PCB and will alternate open and closed keeping the Lock Thermoactuator activated until 1 1/2 minutes before the end of the cycle. At this point the contact opens and removes power to the Lock Thermoactuator. The micro-controlled PCB also sends a signal to the main relay PCB and out through P17. The brown/yellow wire from P17 at main relay PCB supplies 115VAC to Drain valve which closes the valve. The reversing operation which will alternately provide the direction of tumble for the wash basket will be given commands to the VFD through the data cables at P6 micro-controlled PCB. The Prewash or Wash LED will illuminate at this time powered through the white wires from the micro-control PCB P3 to LED printed circuit board.

Now with a cycle previously; we'll use Normal Wash; the washer fills the tub through the back of the machine with either one or both the C1 Cold and H1 Hot Water Valves. At the beginning of the wash cycle bath only after a 90 sec. delay, the detergent dispenser flushes the detergent into the tub for 20 sec.. This is accomplished when 120VAC travels through the red/orange wire to the H2 Hot Water Valve Solenoid. As the washer fills with water, the Wash Basket will tumble one direction for 12 seconds, pause, and then reverse direction for 12 seconds. 120VAC goes through the P19 connection of main relay PCB on wht/brn to the C1 cold water valve and the red/yellow wire to the H1 hot water valve if programmed. When the water reaches the predetermined level the Pressure Switch moves switch contacts to the full position and shuts voltage off to the both water valves. Between red wire from P5 micro-controlled PCB on pressure switch contact and yellow and orange wire from P5 micro-controlled PCB at other pressure switch contact a 5 VDC reading will open.

---

## Wash Circuit

As the washer fills the tub through the back of the machine with either one or both the C1 Cold and H1 Hot Water Valves, the Wash Basket will tumble one direction for 12 seconds, pause, and then reverse direction for 12 seconds. This is accomplished through the use of a variable frequency drive. The time of the bath is programmable up to 15 minutes per bath used.

## Drain, Rinse 1 & 2, & Final Rinse Circuit

When the bath ends the micro-controller PCB removes 115 VAC power from brn/yel coming from main relay PCB at P17 to the Drain Valve. The normally-open spring-loaded Drain Valve opens and empties the tub. For Rinse 1 & 2, the Rinse LED will illuminate. The rinse water temperatures are programmable and will fill as above. For the Final Rinse, the Final Rinse LED will illuminate. These water temperatures are programmable also and will fill as described above. Also the softener dispenser will flush cold water from C2 cold water valve solenoid at beginning of final rinse bath for 20 sec..

## Extract Circuit

The Spin LED will illuminate and the washer controller PCB sends a signal to the Variable frequency drive via the data cable at P6 to VFD RJ-11. The rotation as viewed from front during spin will be CCW except for the 18 lb washer it will spin CW. The motor is a 3 phase 230 VAC type motor for all models .

## Thermoactuator and Shake Out Circuit

The Lock Thermoactuator loses power and opens 1 1/2 minutes before the end of the cycle . This allows the Thermoactuator time to retract by the end of the cycle. To insure that the Lock Thermoactuator has retracted by the end of the cycle, 1 minute prior to the end of the cycle, the Unlock Thermoactuator is powered with 115VAC through the org/red wire from P17 at main relay PCB. The basket will come to a stop from extract speed with the assistance of dynamic braking resistors wired in parallel to the variable frequency drive. The washer will then tumble for 45 seconds to let the clothes shake loose and then stop.

## End of Cycle Circuit

The machine is now stopped and does 2 things: 1. The beeper will signal for 5 seconds letting the user know that it is the end of the cycle. 2. The micro-controlled PCB resets and display will reset when door is opened and it is now ready to run again.

# Drive Motor Inverter Type Motor-Winding Resistance Chart

## 30lb A-Series Washer

Motor	Winding	Wire #	Resistance	
			Minimum	Maximum
30lb 1ph or 3ph 60hz	Main (wash & spin)	T1 & T2	2.45	2.71
Dexter #9376-305-001		T2 & T3	2.45	2.71
A.O. Smith #19343600		T1 & T3	2.45	2.71

NOTE: Resistance values are measured at the stator. Values at the end of the motor wiring harness may be slightly higher.

# Wiring Schematic for 60hz OPL Washer

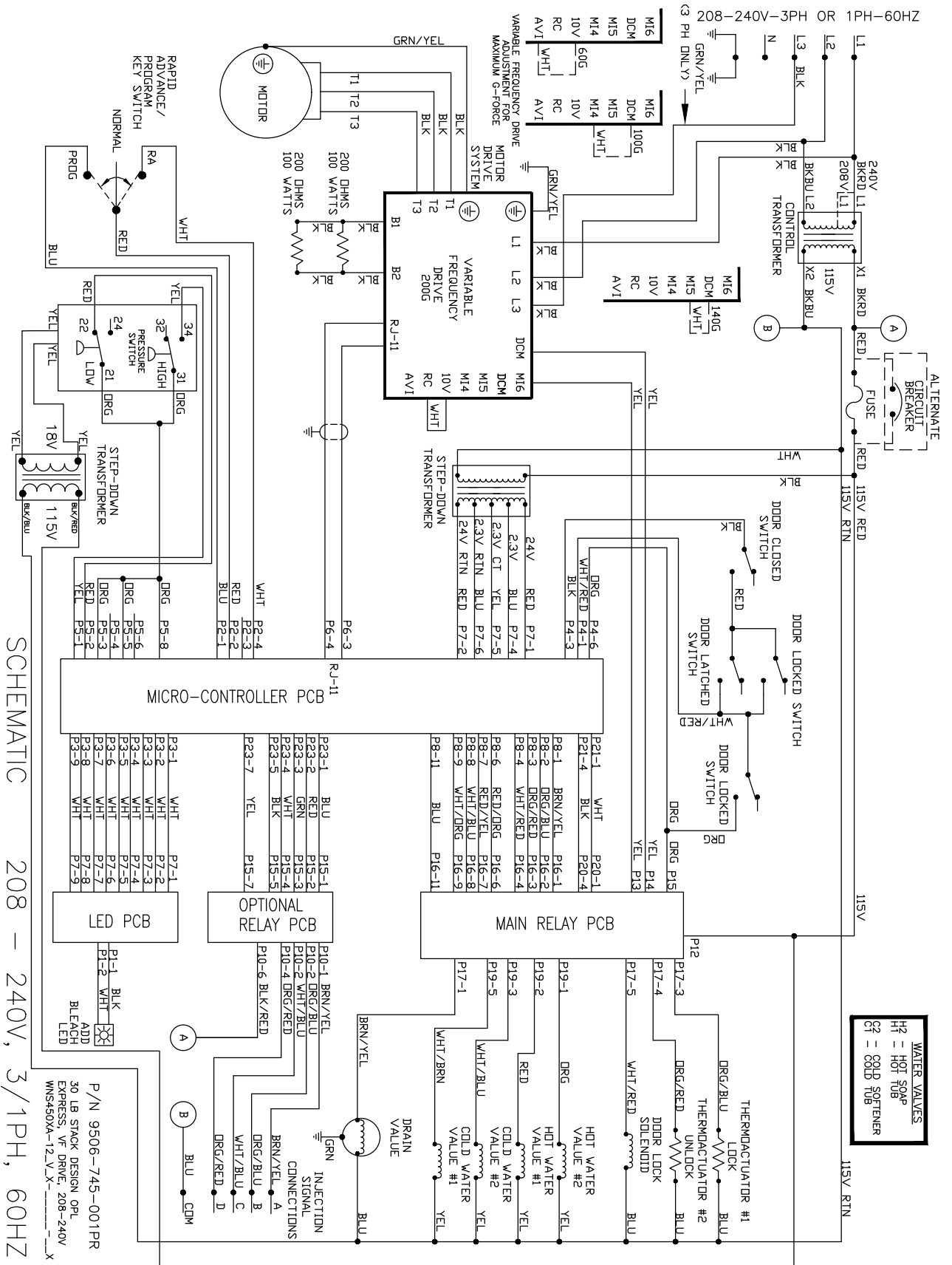

# Wiring Diagram for 60hz OPL Washer

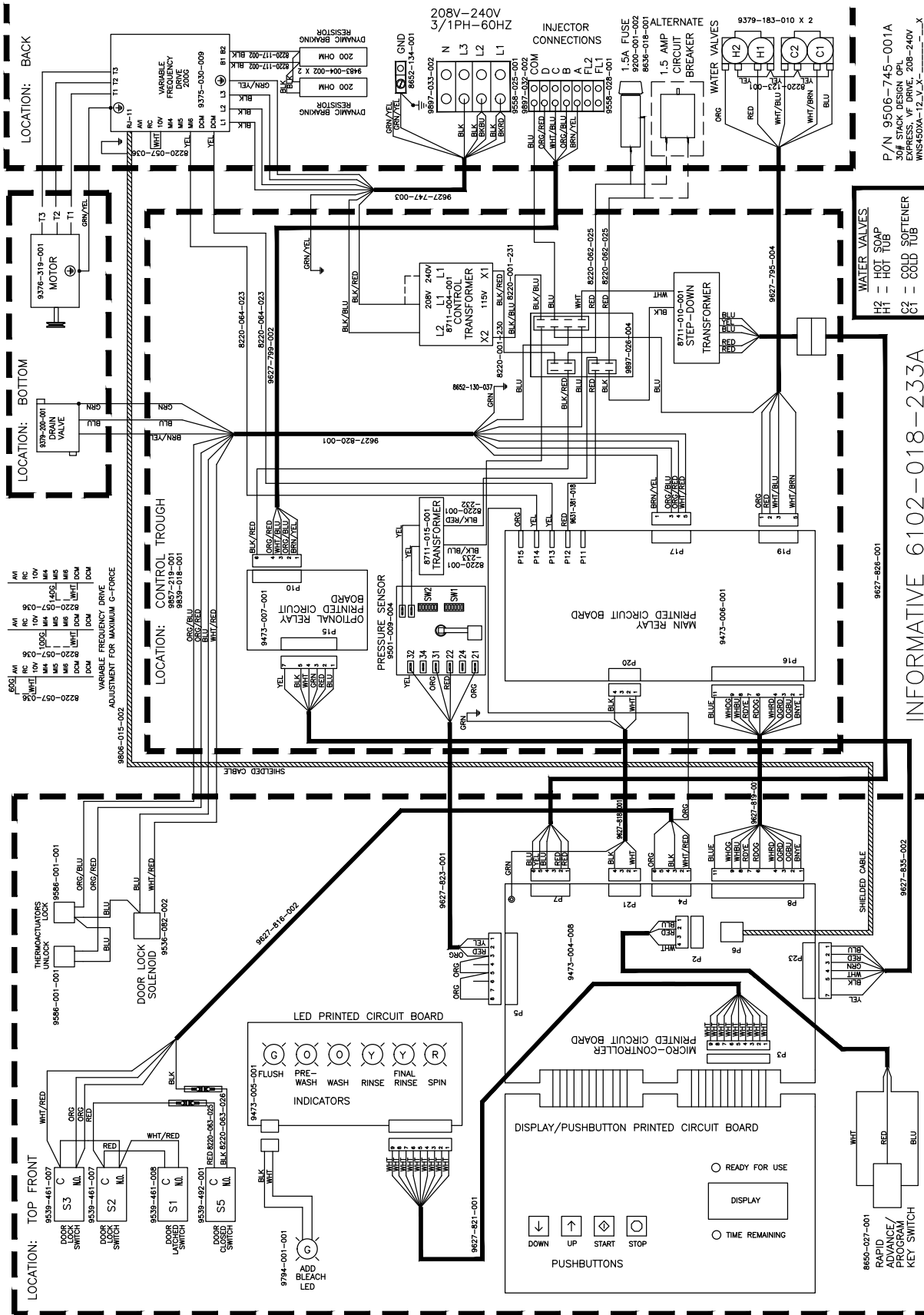

P/N 9506-745-001A  
30" STACK DESIGN OPL  
EXPRESS, VF DRIVE, 208-240V  
WNS4500A-12\_V\_X

INFORMATIVE 6102-018-233A

WIRING DIAGRAM 208-240V, 3/1PH, 60HZ

WATER VALVES  
H2 = HOT SOAP TUB  
H1 = HOT TUB  
C2 = GOLD SOFTENER  
C1 = GOLD TUB



# Section 11:

## Washer Parts

## Kits, Assemblies, & Common Parts

Description	Part Number
Kit - Door Lock Assy. & Cam, replaces 9885-024-001	9732-347-001
Kit - Door cam replacement	9732-346-002
Kit - Locking Pawl replacement	9732-346-001
Kit - 8650-012-003 Lock with spacer	9732-344-001
Kit - 3" Drain valve seal replacement	9732-327-001
Drain Valve 3"	9379-200-001
Water Valve	9379-183-012
Diaphragm	9118-049-003
Cylinder Plug	9456-041-007
Electronic Pressure Switch	9732-314-001
Breaking Resistors	9483-004-002
Main Control Transformer	8711-004-001
Stepdown Transformer	8711-010-004
Transformer 120/24VAC, 5VA	8711-115-001
Control Board	9473-070-001
Data Cable	9806-015-002
Door Lock Gear Motor Solenoid Assembly	9985-011-009
Door Lock Latching Assembly	9885-024-001
Door Handle	9244-091-001
Door Switch	9539-492-001
5/16 Hex Screw	9545-008-026
Belt	9040-077-003
Fuse	8636-018-001
Fuseholder	9200-001-002
Door Glass Gasket	9206-419-001

## SWD OPL V-Series Accessories

Key	Description	Part Number	Qty
*	Mounting Base 4"	9945-110-001	1
*	Mounting Base 6"	9945-111-001	1
*	Bevel Washer for 5/8" bolt used in installations using angle iron bases	8641-586-002	4
*	Bevel Washer for 3/4" bolt used in installations using angle iron bases	8641-586-003	4
*	Kit, Door Gasket Expander (large)	9732-139-002	1
*	Kit, Door Gasket Expander (small)	9732-139-001	1
*	Hose, Water Supply 3/8" I.D. x 48"	9990-027-011	2
*	Washer, Inlet Hose (furnished)	8641-242-000	1
*	Strainer, Inlet Hose (furnished)	9565-003-001	1
*	Sealing compound	8538-151-001	1
*	Flow Restrictors (in dispenser )	9475-002-003	3
*	Battery 3V Lithium (used on Control PCB)	8612-001-001	1
*	Mode Light Support	9635-022-001	1

## WSVD Wiring Harnesses Parts

Key	Description	Part Number	Qty
1	Add Bleach Light, (Wiring Harness included)	9794-001-001	1
2	Wiring Harness, Door Lock P15/P4	9627-816-002	1
3	Wiring Harness, Optional Relay Board (Soap Injection)	9627-835-002	1
*	Wiring Harness, Optional Relay Board to Soap Injection terminal block	9627-799-002	1
4	Wiring Harness, Drain,Thermo,DoorSol P17	9627-820-001	1
5	Data Cable	9806-015-002	1
6	Wiring Harness P20/P21	9627-818-001	1
7	Wiring Harness P8/P16	9627-819-001	1
8	Wiring Harness WaterValve/P19	9627-795-004	1
9	Wiring Harness LED PCB	9627-821-001	1
*	Wire Yellow Jumper (water valve)	8220-123-001	1
*	Harness Power Terminal Block	9627-747-003	1
10	Harness-Extention, Transformer	9627-826-001	1
12	Harness-P5/Pressure Switch	9627-823-001	1
*	Fuse-1.5a	8636-018-001	1
*	Fuseholder-Assembly	9200-001-002	1
*	Circuit Breaker (optional) 1.5 AMP	5198-211-004	1
*	Wiringlabel-diagram & Schematic	9506-745-001	1

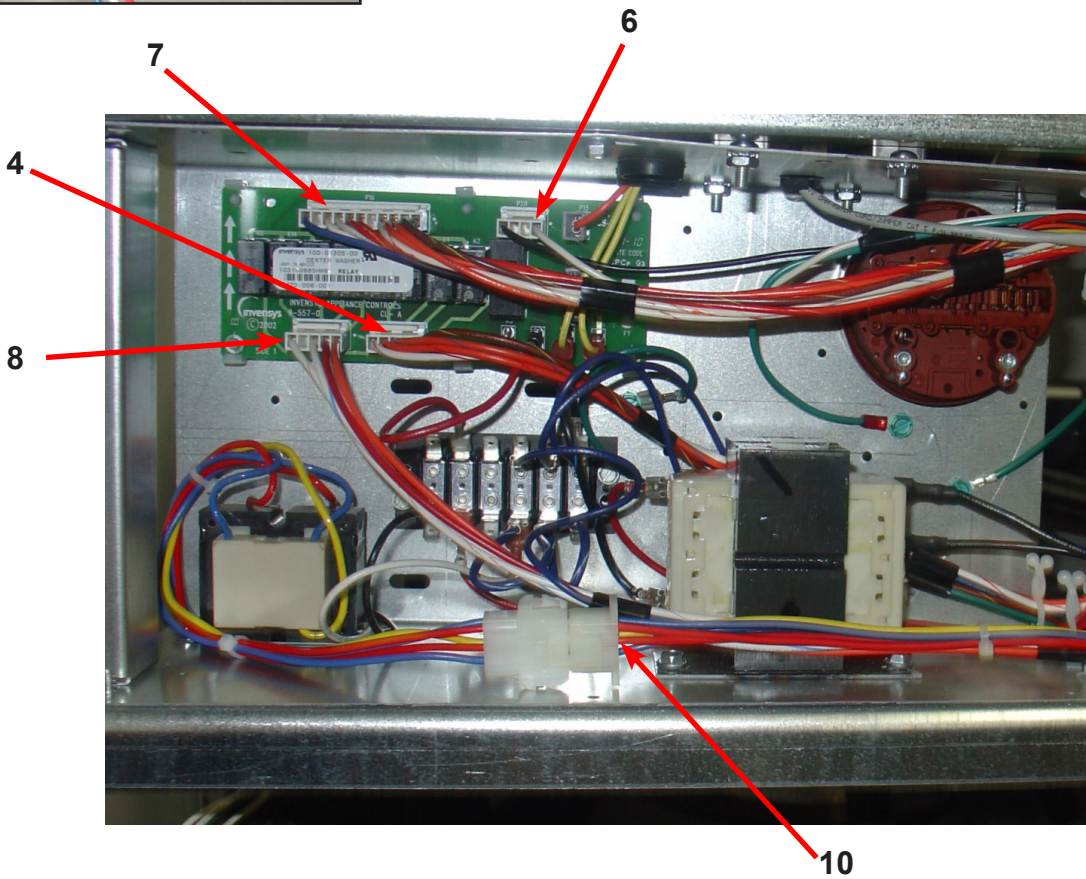
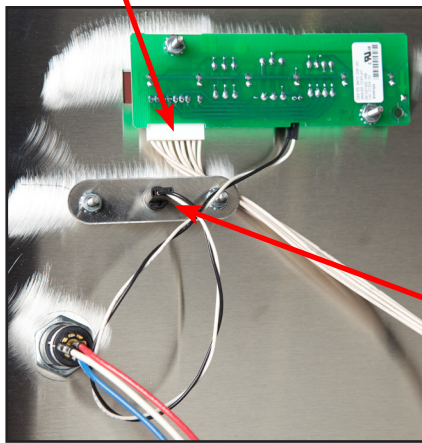
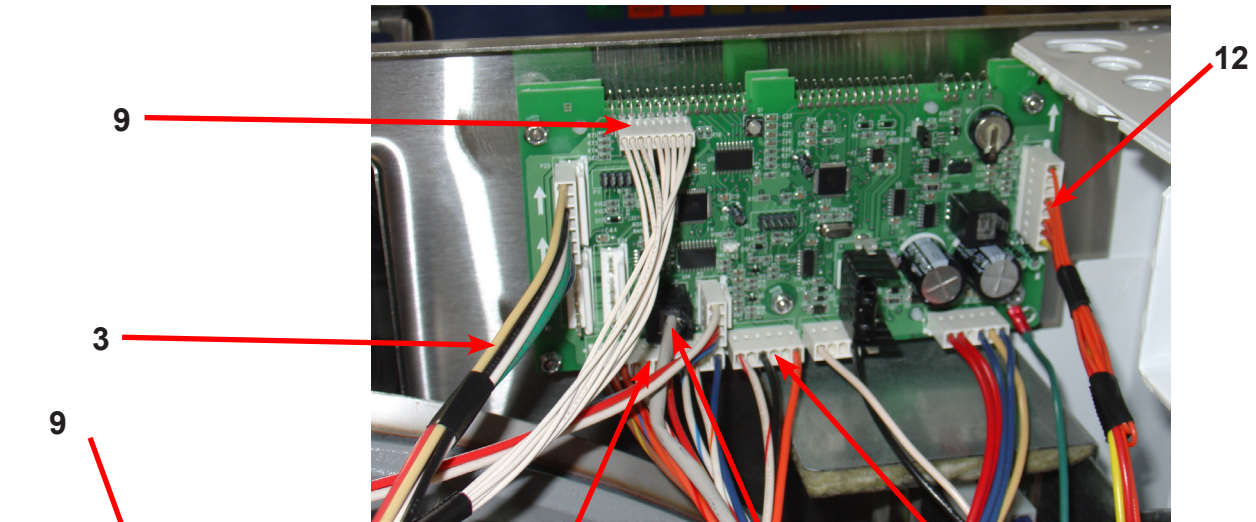

# WSVD Electrical Components

Key	Description	Part Number	Qty
1	Trough Assy,Controls 208-240 volt	9857-219-001	1
	Trough only	9839-018-001	1
2	Transformer, Control (208/230/60 Hz In 115,150VA Out Volts)	8711-004-001	1
*	Wire Assembly, Red 28"	8220-062-025	2
*	Screw, #10B x 1/2	9545-008-026	4
*	Lockwasher #10	8641-582-006	4
*	Wire Assembly, BLK/BLU	8220-001-231	1
*	Wire Assembly, BLK/RED	8220-001-230	1
*	Terminal Block Assy, POWER	9897-026-004	1
*	Screw, Mtg 8Bx3/4"	9545-045-007	2
3	Transformer, Step Down (120VAC In, Sec-1, 24.3, Sec-2, 2.3VAC)	8711-010-001	1
*	Harness-extention, Transformer	9627-826-001	1
*	Screw, 8B x 1/4	9545-045-001	2
*	Lockwasher #10	8641-582-005	2
*	Wire Assembly, P12, Red 7"	9631-381-018	1
4	PCB assembly Relay Main	9473-006-001	1
*	Wiring Harness, Door Lock P15/P4	9627-816-002	1
*	Wiring Assembly Yel. 32" P14 & P13	8220-064-023	2
5	Wiring Harness, Drain,Thermo,DoorSol P17	9627-820-001	1
*	Wiring Harness WaterValve/P19	9627-795-004	1
*	Wiring Harness P8/P16	9627-819-001	1
*	Wiring Harness P20/P21	9627-818-001	1
6	Pressure Switch	9539-457-004	1
*	Harness Assembly, Pressure Switch	9627-822-001	1
*	Kit-Pressure Sensor, Electronic	9732-314-001	1
7	Kit-Repaacement, Pressure Sensor (only)	9732-315-001	1
*	Support-PCB, 3/8", Edge Holding	9458-285-001	1
8	Transformer-120/18VAC, 5 VA	8711-015-001	1
*	Screw, 8B x 1/4	9545-045-001	1
*	Wire Assy BLK/BLU	8220-001-233	1
*	Wire Assy RED/BLU	8220-001-232	1

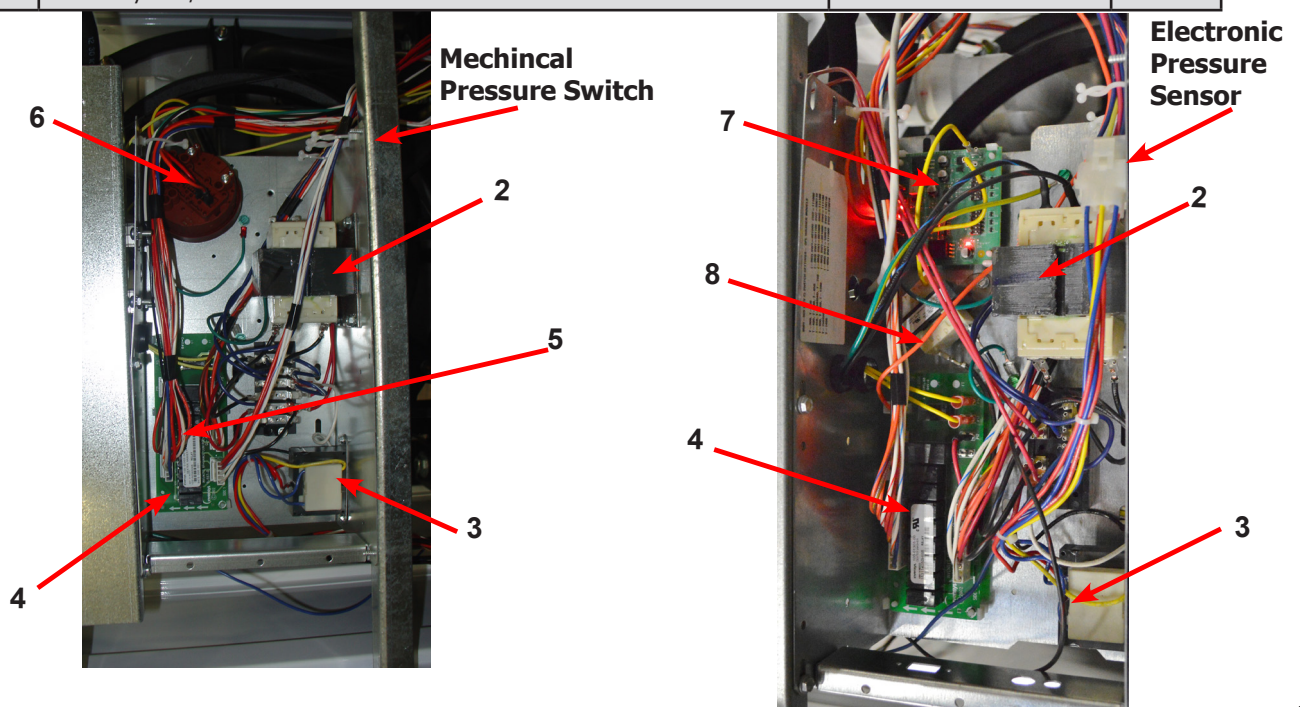

# WSVD Electrical Components

Key	Description	Part Number	Qty
1	Terminal Block Assy, POWER	9897-033-002	1
*	Screw, Mtg 6ABx3/4"	9495-031-010	2
2	Strip, Terminal Marker	9558-025-001	1
3	Terminal, Lug-Solderless (Ground)	8652-134-001	1
*	Screw, 10-32TTx1/2 Green (Control Trough)	9545-008-027	1
*	Wiring Harness Power Terminal To VFD & Control Transformer and ground wire	9627-747-003	1
4	VFD Delta drive 208-240 volt	9375-030-009	1
*	Cable, Data Communication	9806-015-002	1
*	Wiring Assembly Yel. 32"	8220-064-023	2
5	Braking resistors (200 ohm)	9483-004-002	2
*	Wire Assembly, BLK (Breaking Resistors)	8220-118-002	2
*	Wire Assembly-Jumper, BLK (Breaking Resistors)	8220-117-002	2
*	Label Fuse 1.5 amp Rear	8502-716-001	1
*	Fuse-1.5a	8636-018-001	1
6	Fuseholder-Assembly	9200-001-002	1
*	Circuit Breaker (optional) 1.5 AMP	5198-211-004	1
7	Terminal Block Assy, Injector	9897-032-002	1
*	Screw, Mtg 8Bx3/4"	9545-053-002	2
*	Strip, Terminal Marker (Injector)	9558-028-001	1
*	PCB assembly Relay Optional (Soap Injection)	9473-007-001	1
*	Harness-P23/15	9627-835-002	1

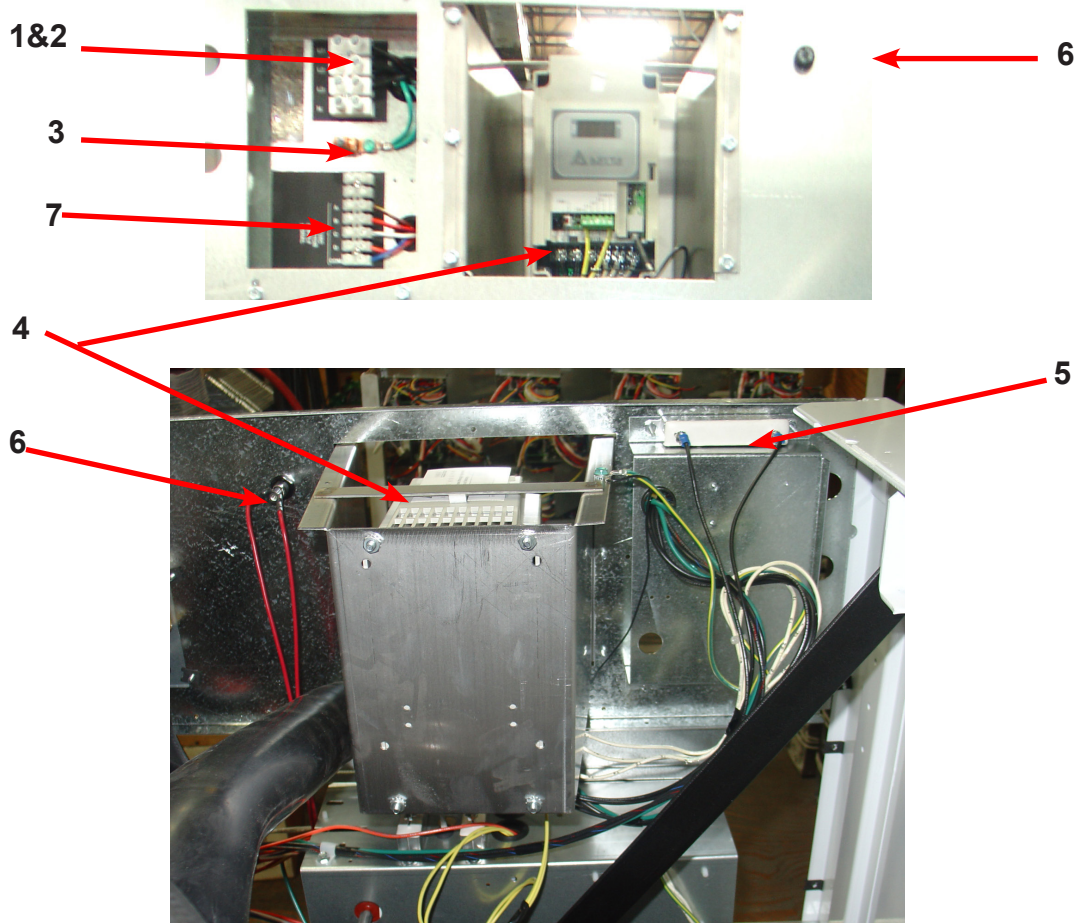

# WSVD Front Panel Control Group

Key	Description	Part Number	Qty
*	Nameplate,Control Panel (one piece)	9412-232-001	1
1	PCB assembly Control /Display (OPL)	9473-004-009	1
*	Spacer Pushbutton (Micro)	9538-192-001	5
*	Retainer Pushbutton (Micro)	9486-150-001	1
*	Nut Hexelasticstop #4-40	8640-424-002	2
*	Pushbutton Control (OPL)	9035-062-003	1
*	Spacer Plastic #6x9/16	9538-157-018	5
*	Nut Elasticstop #6-32	8640-411-002	4
*	Nut-Hexkeps, #6-32	8640-411-003	1
2	Harness LEDPCB	9627-821-001	1
3	Harness Doorlock, Switches	9627-816-002	1
4	PCB assembly Mode lights	9473-005-001	1
*	Spacer Plastic #6x9/16	9537-157-018	2
*	Nut Hexkeps #6-32	8640-411-003	2
5	Light, LED,ADD BLEACH Assembly	9794-001-001	1
*	Spacer Plastic #6x9/16	9538-157-018	2
*	Nut Hexeps #6-32	8640-411-003	2
6	Lock, Run/Program, w/Harness	8650-027-001	1
7	Battery	8612-001-001	1
8	PCB assembly Relay Optional (Soap Injection)	9473-007-001	1
9	Harness-P23/15	9627-835-002	1
10	Wiring Harness, Optional Relay Board to Soap Injection terminal block	9627-799-002	1

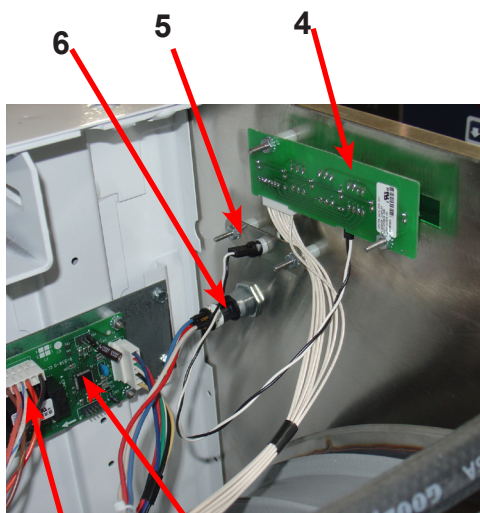

10 8

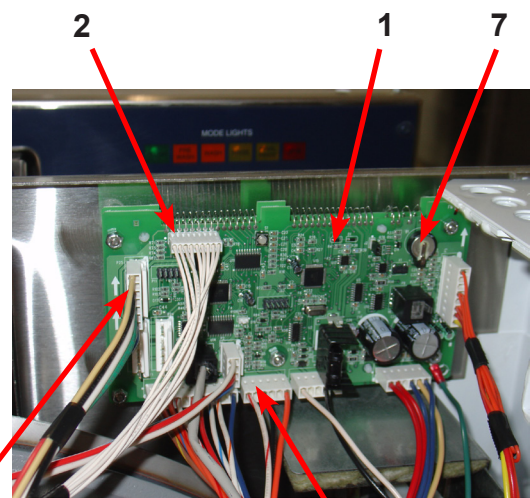

9 3 7 1 2

# WSVD Labels and Diagrams

Key	Description	Part Number	Qty
*	Wiring Diagram & SchematicOPL	9506-745-001	1
*	Transient Voltage Surge Suppressor Informational	8507-330-001	1
1	Label High Voltage Warning	8502-614-005	1
2	Label Fusing & Installation	8502-619-004	1
*	Label Warning Risk of Injury	8502-759-001	1
*	Label Warning Door Opening	8502-757-001	1
*	Booklet Owners	8514-249-001	1
3	Label "EXPRESS" , Soap Dispenser (Black)		
4	Label-Control Name Plate (Black)	9412-204-001	1
5	Label Top Dispenser (Black)	8502-745-001	1
6	Label-Connection Electrical	8502-649-001	1
*	Label-Connections Injector	8502-647-002	1

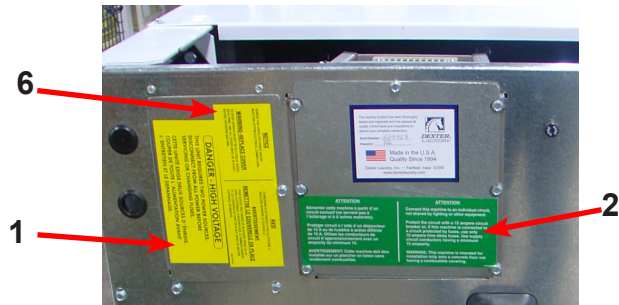

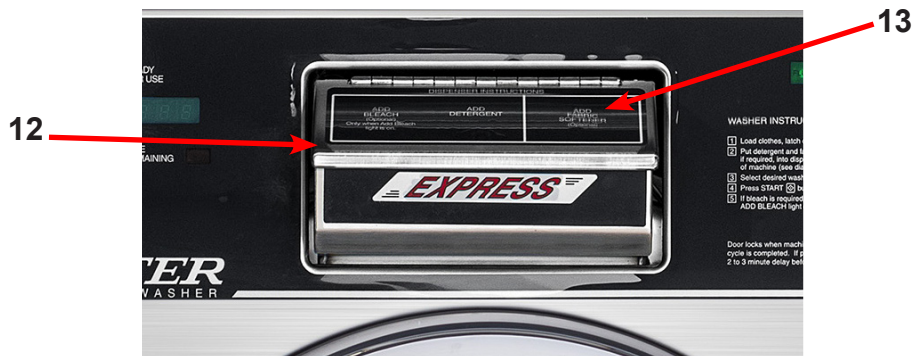

Key	Description	Part Number	Qty
*	Panel, Right Side-Painted	9989-493-002	1
*	Panel, Left Side - Painted	9989-494-002	1
*	Screw, (Side Panel to Base)	9545-018-023	8
*	Plate-Assy, Fastner Side Panel	9982-318-001	8
1	Panel Assy, Front	9989-556-001	1
2	Lock, Run/Program, w/Harness	8650-027-001	1
3	Bumper Loading Door	9051-055-001	1
4	Screw, 10AB x 3/4 Torx Chrome	9545-008-020	4
5	Screw, 10AB x 3/4 Torx Black	9545-008-010	2
*	Nut, Spring-To Front Panel	8640-442-001	4
*	Label, Door Opening (Black)	8502-757-001	1
*	Label, Risk of Injury (Black)	8502-759-001	1
7	Retainer Pushbutton (Micro)	9486-150-001	1
7	Nut Hexelasticstop #4-40	8640-424-002	2
7	Pushbutton Control (OPL) (Black)	9035-062-003	1
8	Nameplate Decal, Control Panel (Black)	9412-232-001	1
9	Panel Top, Front, Painted	9989-470-002	1
*	Screw, Hex, #10B x 1/2	9545-008-026	6
*	Panel Top Rear	9454-717-001	1
*	Screw, Hex, #10B x 1/2	9545-008-026	6
*	Optional Top Panel for Stand alone washer	9454-729-001	1
12	Soap Dispenser Assembly, Complete (Does not include lid)	9807-087-001	1
*	Soap Box mounting Gasket	9206-422-001	1
13	Lid Assembly soap box	9987-104-001	1
13	Label, Dispenser Instructions, Black	8502-745-001	1
*	Lid screws #10-32x1/2 SS	9545-012-017	2
*	Nut Hex Elasticstop #10-32 SS	8640-413-006	6
*	Bracket Soap box mounting	9029-122-002	1
*	Softner siphon tube (plastic)	9574-252-002	1
*	Flow restrictors	9475-002-003	3
14	Door, Lower Service Assembly (w/handle)	9960-286-006	1
15	Handle, Lower Service Door	9244-086-005	1
16	Screw, Torx Head- 10AB x 3/4,	9545-008-020	4

# Door Lock Assembly

Key	Description	Part Number	Qty
*	Lock Assy, Complete (#1-22)(includes #1 thru #22)	9885-024-001	1
1	Plate Assy, Door Lock	9982-346-001	1
2	Washer, Flat	8641-581-030	1
3	Actuator, Latching Switch	9008-005-001	1
4	Pawl, Locking	9732-346-002	1
5	Washer, Spring	8641-569-003	1
6	Ring, Retaining	9487-200-004	1
7	Bracket Switch	9029-163-001	1
8	Nut, Hex 10-32 UNF	8640-413-002	2
9	Spring, Actuating	9534-364-002	1
10	Screw, Hx. 10-32 x 1"	9545-012-020	1
11	Nut, Elastic Stop 10-32	8640-413-004	2
12	Spring, Return	9534-364-001	2
13	Pin, Guide	9451-193-001	1
14	Ring, Retaining	9487-200-005	1
15	Washer	8641-581-031	2
16	Switch, Latching Sensing	9539-461-008	1
17	Shield, Switch	9550-169-003	4
18	Screw 4-40 x 5/8"	9545-020-001	2
*	Nut, Twin 4-40	8640-401-001	1
19	Switch, Locking Sensing	9539-461-007	2
20	Actuator, Switch Locking	9008-006-003	1
21	Screw 4-40 x 1 1/8"	9545-020-003	2
21	Nut, Twin 4-40	8640-401-001	1
22	Pin, Dowel	9451-181-004	1
*	Spacer Sensor	9538-182-001	*
*	Shim, Door Lock, Thin	9552-037-001	AR
*	Screw, Lock mtg 1/4"-20 x 3/4"	9545-018-004	3
*	Lockwasher 1/4" Ext tooth	8641-582-007	3
*	Door Stud Pin, 3/16" x 3/4"	9451-181-004	1

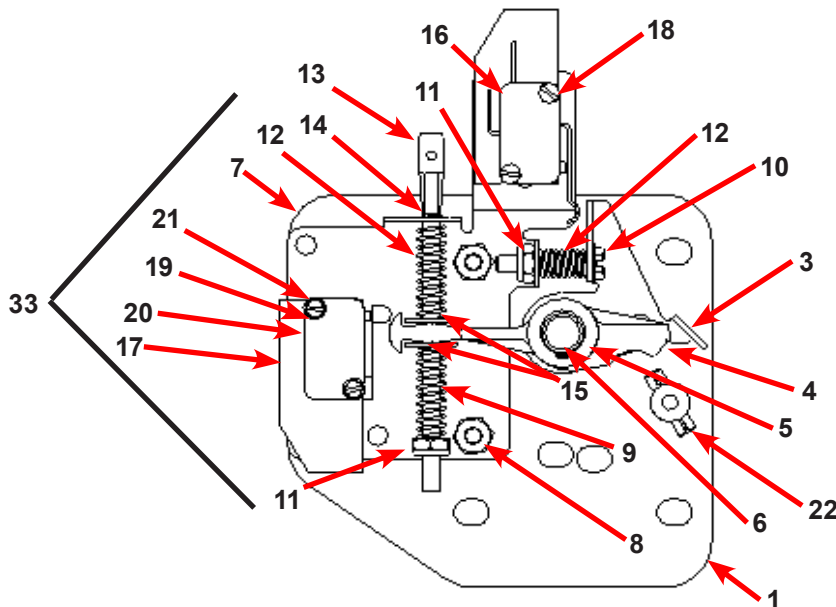

# WSVD Door Lock Solenoid Assembly

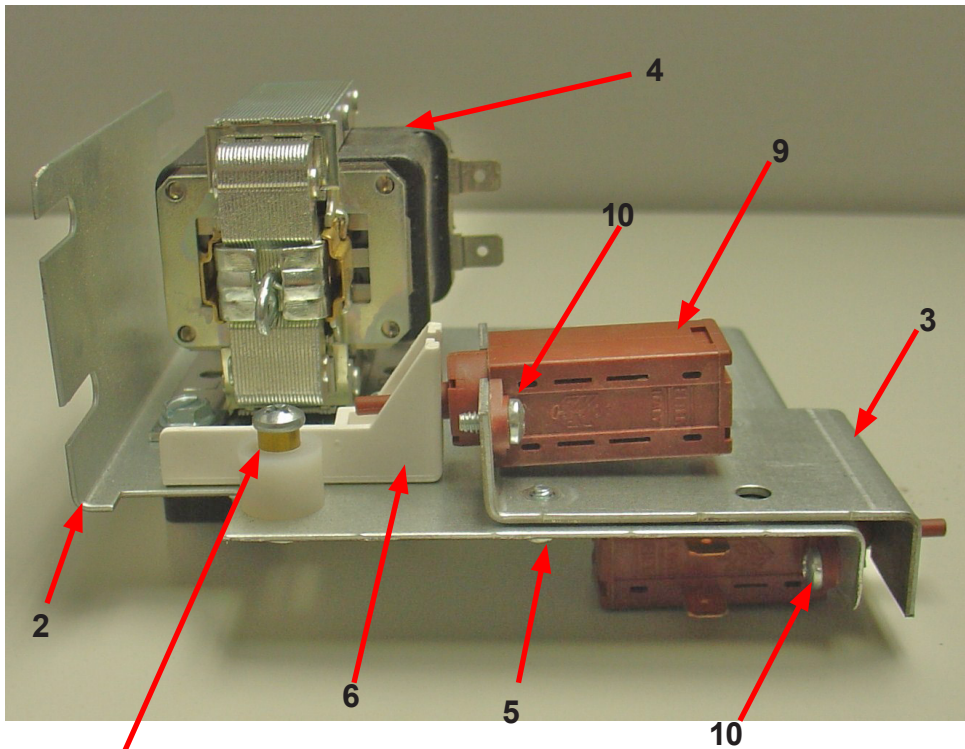

11, 12, 13

Key	Description	Part Number	Qty
1	Solenoid Ass'y, Door Locking (includes 23 thru 32)	9922-011-009	1
2	Bracket, (Door Locking Solenoid)	9985-169-001	1
3	Bracket Ass'y, Solenoid Slide	9029-074-001	1
4	Solenoid 120V 60 hz	9536-082-002	1
5	Screw, Solenoid Mtg	9545-008-001	4
6	Stop, Door Lock Solenoid	9540-036-001	1
7	Screw, Shoulder	9545-061-001	1
*	Nut, Keps #6	8640-411-002	1
9	Thermoactuator 120 V	9586-001-001	2
10	Screw #6 x 5/16"	9545-031-011	4
11	Spacer, Plastic	9538-157-004	1
12	Spacer, Metal	9538-166-004	1
13	Screw, Cross Recessed	9545-010-001	1
14	Nut, Keps #8	8640-412-005	1
*	Rod, Pull	9497-225-008	1
*	Nut, Sol. Brkt. to Control Panel	8640-412-005	3
*	Gear Motor Kit	9732-283-003	*

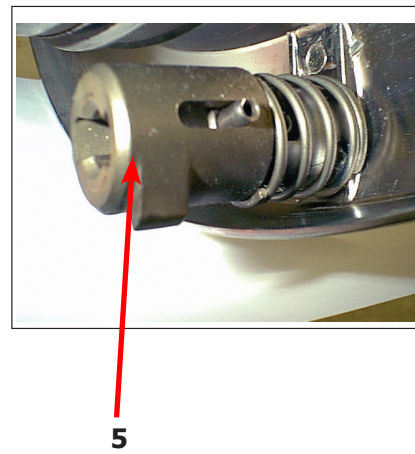
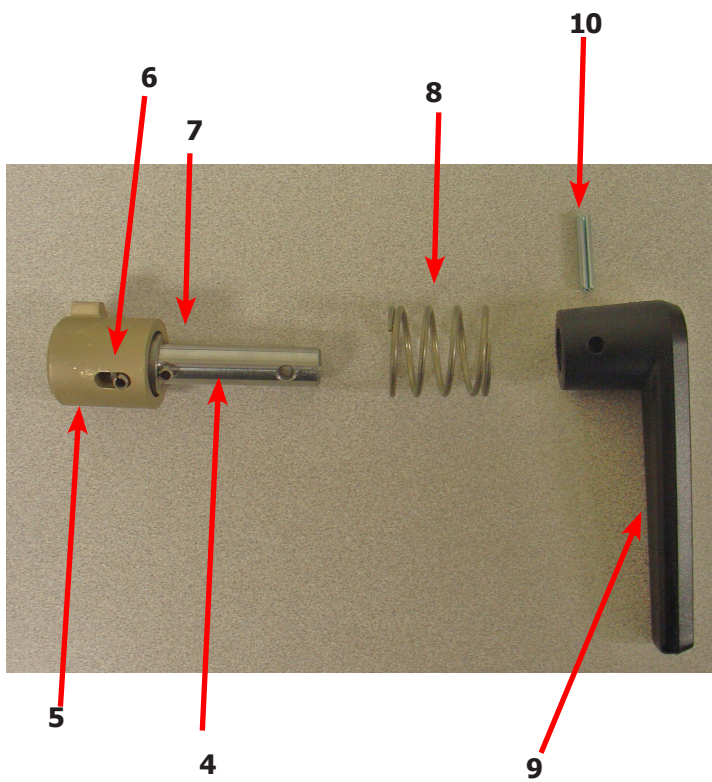
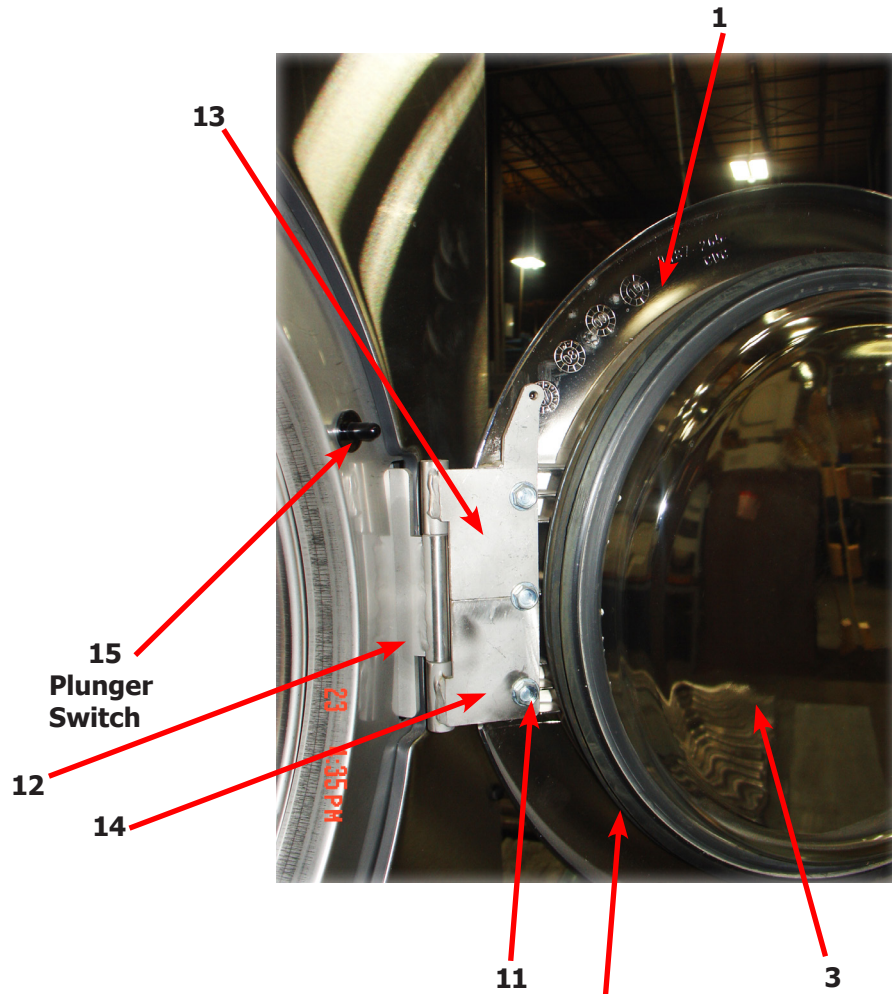

## WSVD Loading Door Group Part #

Key	Description	Part Number	Qty
	Loading Door, Complete #1-10	9960-309-001	1
1	Loading Door, Ring (180 Degree)	9487-265-002	1
2	Gasket, Loading Door	9206-419-001	1
3	Window, Loading Door	9635-016-001	1
*	Shaft Assy, Locking (includes 4 thru 7)	9913-134-003	1
4	Shaft, Door Locking	9537-195-002	1
5	Cam, Locking	9095-040-002	1
6	Pin, Groove (1 1/4)	9451-181-005	1
7	Pin, Groove (3/4)	9451-181-004	1
8	Spring, Lock Cam	9534-360-002	1
9	Handle, Door	9244-091-001	1
10	Pin, Door Handle (groove)	9451-181-005	1
11	Screw, Loading Door Mtg (5/16" TF)	9545-056-002	3
*	Shim, Loading Door Hinge, Thin	9552-037-001	1
12	Door Hinge Assembly Mounts to Tub Front	9955-030-001	1
*	Screw, Hinge Mtg 5/16" -18x 3/4"	9545-014-009	3
*	Lockwasher 5/16" Ext tooth	8641-582-009	3
*	Rubber Edge (mounts to Front Panel)	9059-063-002	1
*	Nut, Keps	8640-411-003	2
*	Wiring Harness doorlock safety Switch Assembly	9627-816-002	1
*	Wire Assembly Door Close Switch, Red 17"	8220-063-025	1
*	Wire Assembly Door Close Switch, BLK 17"	8220-063-026	1
13	Leaf assembly, Hinge Top (Push Button Style)	9545-008-001	1
14	Leaf assembly, Hinge Bottom	9545-005-002	1
15	Switch, Door closed Switch (Push Button style)	9539-492-001	1
*	Wire Assembly, BLK 17"	8220-062-028	1
*	Wire Assembly, RED 17"	8220-062-027	1

# Drain Valve Group Part # by Model

Key	Description	Part Number	Qty
1	Valve, Drain (includes #2 thru #11)	9379-202-001	1
2	Body, Valve (w/ball)	9064-070-001	1
3	Motor & Gear Train (complete)	9914-137-011	1
4	Plate, Motor Mtg	9452-538-001	1
5	Screw	8639-994-001	1
6	Spring, Drive	9534-339-001	1
7	Screw	9545-054-001	1
8	Screw	9545-054-002	1
9	Seal, V Packer	9532-134-001	1
10	Washer	8641-584-001	1
11	Pin, Main Drive	9451-196-001	1
*	Plate (spacers needed for replacement motor mtg. plate)	9538-149-001	1
13	Stator and Coil Assembly	9089-036-004	1
*	Seal Kit	9732-327-001	1

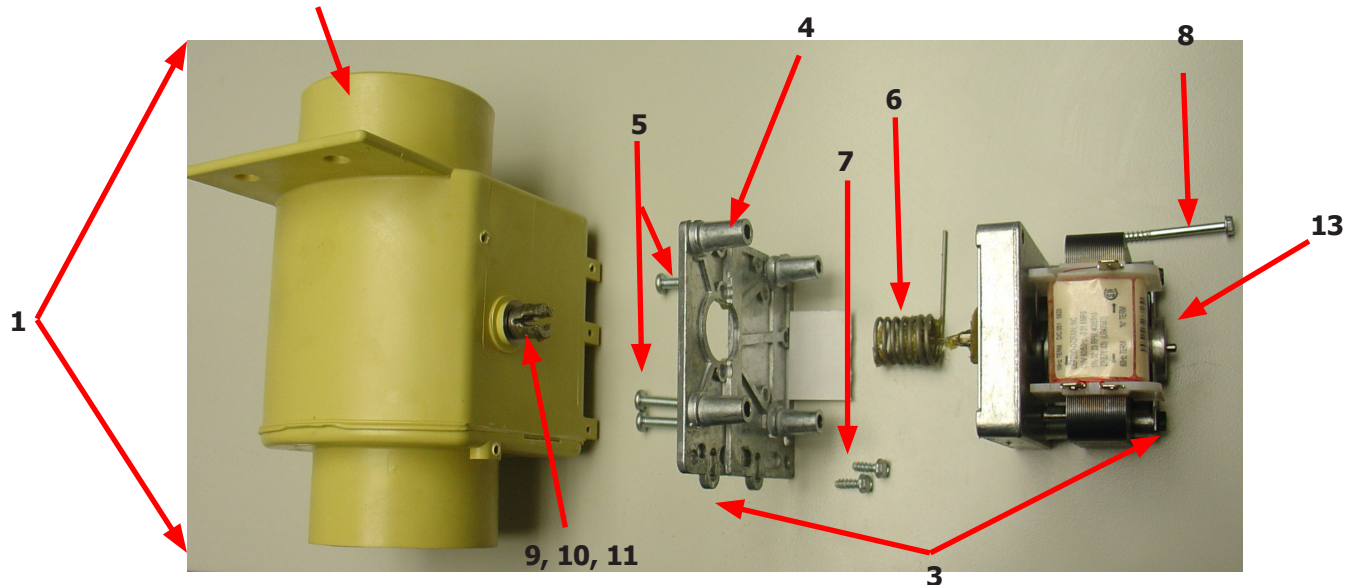
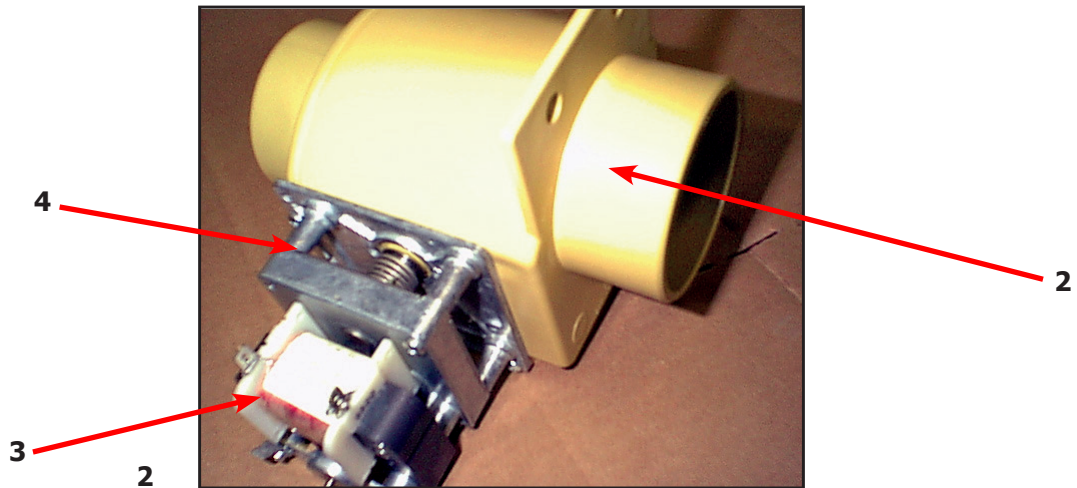

# Water Inlet Valve Breakdown

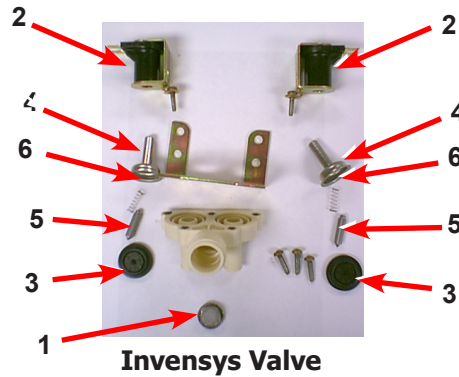

**Invensys Valve**

Key	Description	Part Number	QTY
*	Valve, Water Inlet (includes 1 thru 6) - <b>Invensys</b>	9379-183-012	2
1	Screen, Inlet end of valve	9555-056-001	2
2	Coil Assy., 120 V Invensys	9089-017-001	2
3	Diaphragm Invensys (EPDM)	9118-049-001	2
*	Optional Diaphran (Viaton)	9118-049-002	2
*	Diaphragm Invensys (EPDM NSF)	9118-049-003	2
4	Guide, Solenoid Invensys	9211-021-002	2
5	Armature Invensys	9015-008-001	2
6	Spring, Armature Invensys	9534-298-001	2
*	Optional Diaphran (Viaton)	9118-049-002	2
*	Wiring Harness	9794-001-001	1

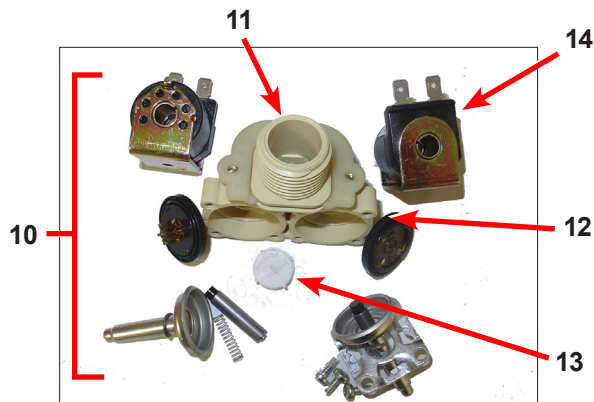

**Optional Mueller Valve**

Key	Description	Part Number	QTY
10	Dual Coil Water Valve Mueller	9379-192-001	2
11	Valve Water Body Complete (no coil)	9379-192-002	1
12	Diaphragm Mueller	9118-054-001	2
13	Filter Mueller	9183-046-001	1
14	Coil Mueller	9089-051-001	2
16	Diaphragm Assembly Mueller	9785-001-001	1

# WSVD Rear View Access Parts Group Part #

Key	Description	Part Number	Qty
1	Drive Motor, 3 Phase (Inverter duty)	9732-127-012	1
2	Rod, Motor Mtg	9497-222-006	1
*	Collar, Shaft (w/set screws) Before Serial # 530726	9076-052-002	2
*	Motor Bushing (plastic) Before Serial # 530726	9053-074-002	2
3	Motor Bushing (Rubber) after Serial # 530726	9053-082-001	2
*	Clamp-Worm, 316SS, 1.5" (for Rubber bushing)	8654-117-019	2
4	Strap Bracket, Motor Tension (After Serial # 525645)	9029-206-002	1
*	Nut, Strap to Motor (After Serial # 525645)	8640-413-002	1
*	Strap Bracket, Motor Tension (Before Serial # 525645)	9029-027-005	1
*	Nut, Strap to Motor (Before Serial # 525645)	8640-414-003	1
*	Washer (Before Serial # 525645)	8641-581-006	1
5	Spring, Belt Tension	9534-319-002	1
*	Bolt, Eye (1/4"-20x1/2")	9545-055-002	1
*	Nut, 1/4 Elastic Stop	8640-414-003	1
*	Pulley, Motor	9453-170-003	1
*	Set Screw,Sq.Hd(motor pulley)	9545-028-015	2
*	Tolerance Ring	9487-234-003	1
6	Pulley, Driven	9453-168-003	1
*	Screw 5/8-11x1/2"	9545-060-001	3
*	Lockwasher 5/8"	8641-582-018	3
*	Washer, Flat 5/8x2 1/4"	8641-581-032	3
7	Drive Belt	9040-077-003	2
8	Channel, Rear	9081-131-001	1
*	Screw	9545-008-026	4
*	Nut, Spring	8640-399-007	4
*	Hose, Overflow to drain	9242-449-004	1
*	Clamp, Hose overflow to drain	8654-117-019	2
9	Hose, Overflow Vent Top	9242-463-005	1
10	Vaccum Breaker	9610-001-002	1
11	Clamp, Hose Vent, Injection Assembly	8654-117-014	3
12	Hose, Vacuum Breaker to tub	9242-461-001	1
*	Hose, Injector to Tub	9242-462-001	1
13	Injection Assy-Soap	9883-008-001	1
*	Cap Injector Assy	0935-127-001	1
14	Hose, Pressure Switch	9242-175-005	1
*	Clamp, Pressure Switch Hose	8654-117-015	1
15	VFD Delta "S" drive 208-240 volt	9375-015-015	1
16	Braking resistors (200 ohm)	9483-004-002	3
17	Bracket assembly (drive mounting)	9985-176-001	1
*	Plastic Plug 7/8" Electrical Connection	8654-117-014	2
*	Panel Assy., Back	9454-714-001	1
*	Screw Panel Mtg.#10Bx1/2"	9545-008-026	10
*	Screw Panel Mtg.#10Bx1/2"	9545-030-002	3
*	Nut, Spring	8640-399-004	8

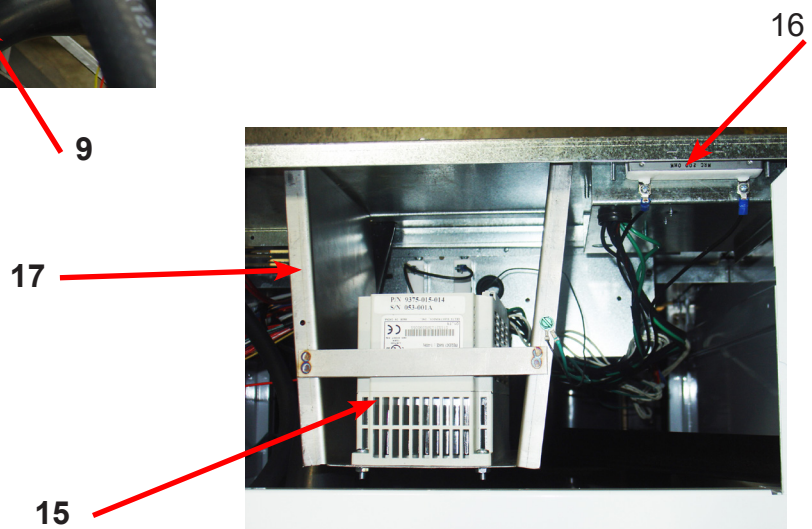
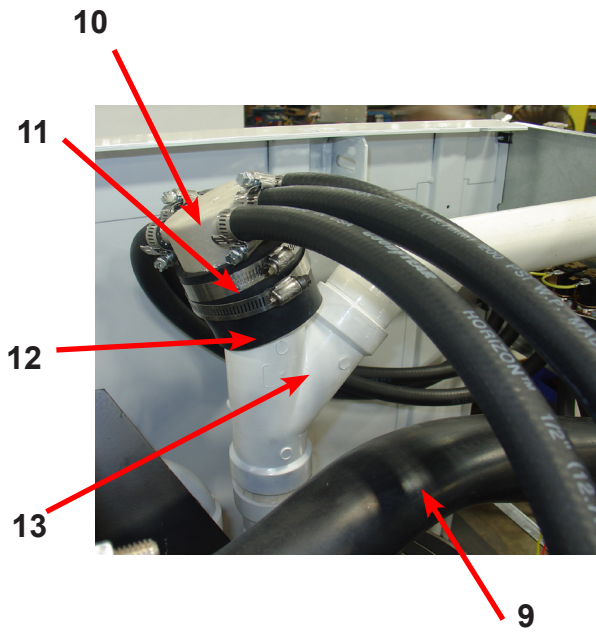
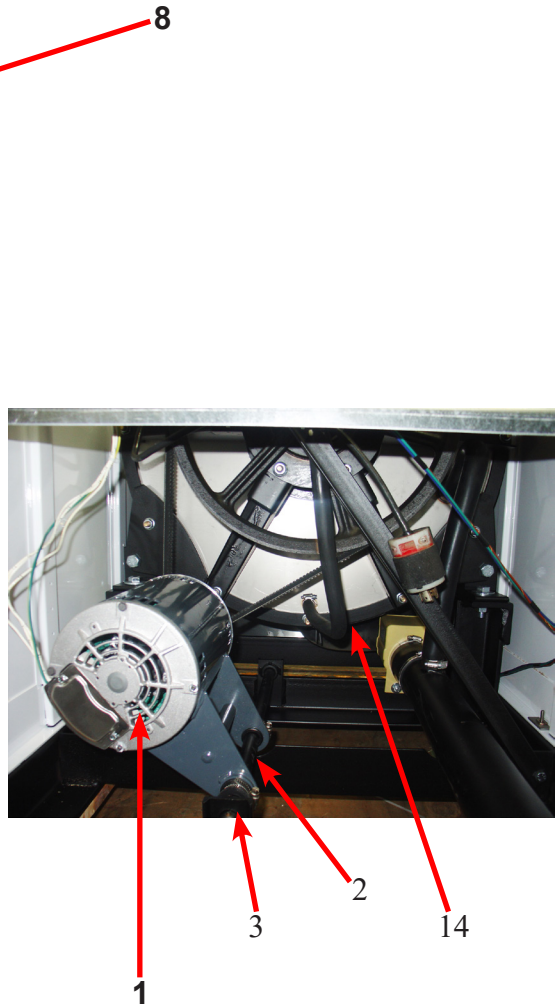
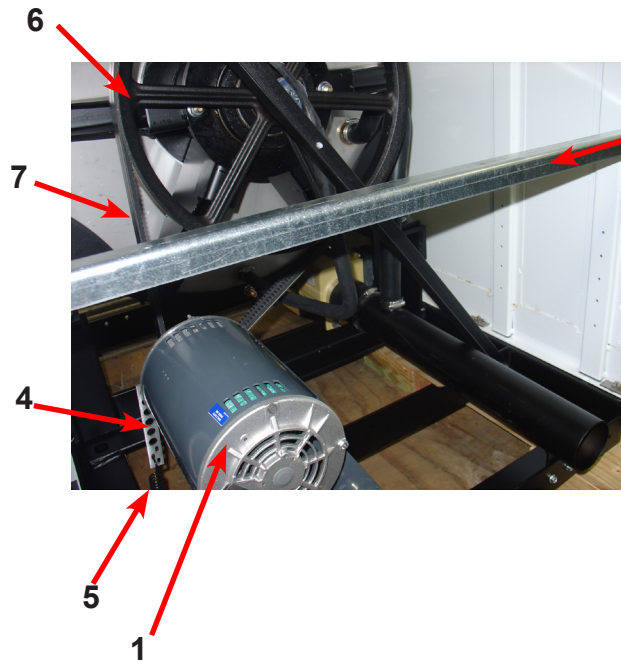

## WSVD Chassis and Drain by Part #

Key	Description	Part Number	Qty
1	Base Assy,Frame	9945-109-002	1
	Tub and Cylinder Complete	9869-011-001	1
*	Outer Tub Assy	9930-140-001	1
*	Cylinder Assy Before Serial # W1.20190.XXX	9732-354-005	1
*	Cylinder Assy After Serial # W1.20190.XXX	9848-167-001	1
3	Back Ass'y, Tub	9962-013-003	1
4	Bolt, 7/16" x 2" Tub Back to Tub	9545-059-002	12
5	Nut, Flange Lock	8640-416-005	12
*	Bolt, 5/8-11 x 1 1/2 Tub to Base, Front	9545-060-001	2
*	Nut, 5/8-11 Wizlok	8640-425-001	2
*	Ring Assy, Tub Mtg-Front	9950-051-004	1
*	Bolt, Top Front Ring 5/8" x 3"	9545-017-016	1
*	Nut WCAD 5/8"	8640-417-005	1
6	Ring Assy.Clamp Tub Mtg.- Rear	9950-056-002	1
7	Bolt, 5/8-11 x 1 1/2 Tub to Base, Rear	9545-060-001	2
8	Nut, 5/8-11 Wizlok	8640-425-001	2
9	Bolt, 5/8-11 x 2 Tub & Rings to Base, Front & Rear	9545-060-004	4
10	Washer	8641-581-038	4
11	Nut, 5/8-11 Wizlok	8640-425-001	4
12	Hose, Overflow	9242-449-004	1
13	Clamp	8654-117-018	2
14	Tube, Over Suds	9242-463-005	1
*	Clamp	8654-117-014	1
15	Hose, Tub to Drain Valve	9242-464-001	1
16	Valve, Drain	9379-187-004	1
*	Screw, Valve to Bracket 5/16-18x1 1/4	9545-014-012	1
*	Nut, 5/16-18	8640-400-003	2
17	Hose, Drain Valve to Tube	9242-457-001	2
*	Clamp, Hose (Drain Valve to Tube)&(Srain Hose to Valve)	8654-117-009	1
*	Screw Tube (Bracket to Base 1/4B x 3/4)	9545-030-002	2
18	Tube Assy, Drain	9915-122-002	2
19	Hose, Vacuum Brkr. to Tub	9242-458-001	1
*	Clamp	8654-117-014	1
20	Hose, Pressure Switch	9242-175-005	2
*	Clamp	8654-117-014	1

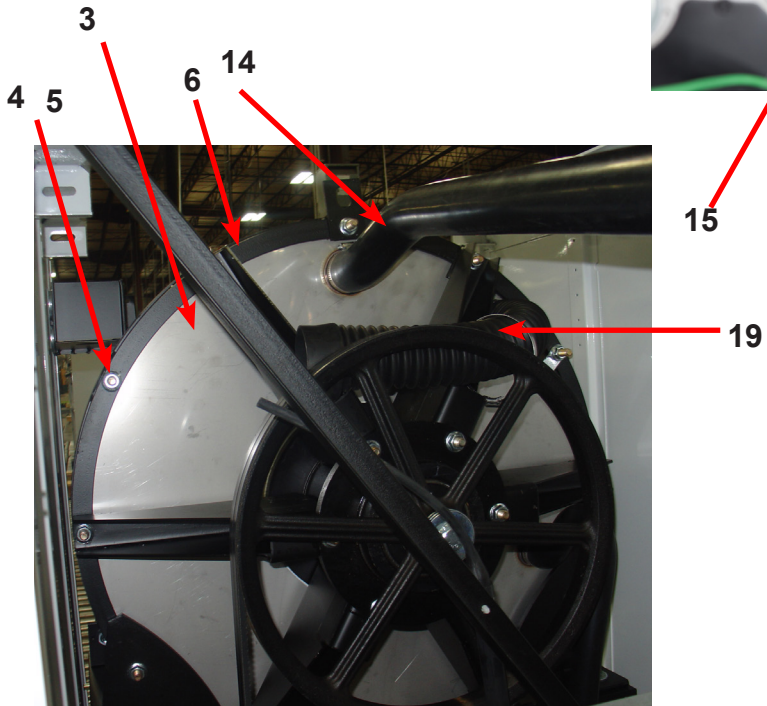
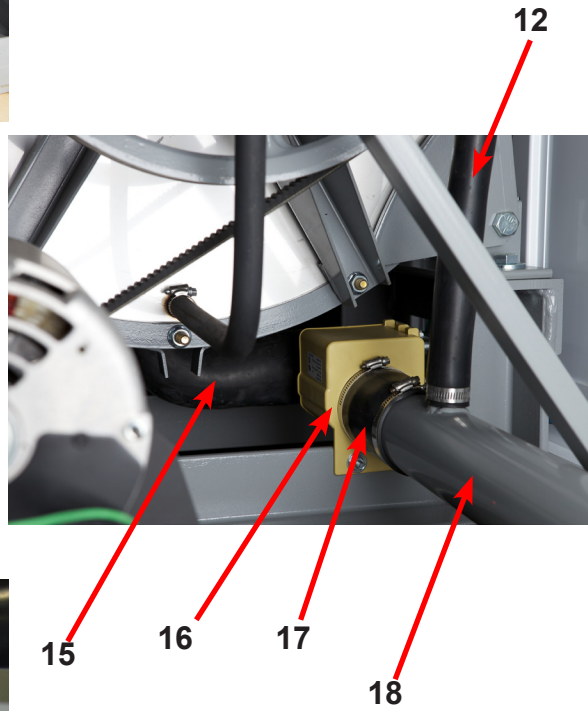
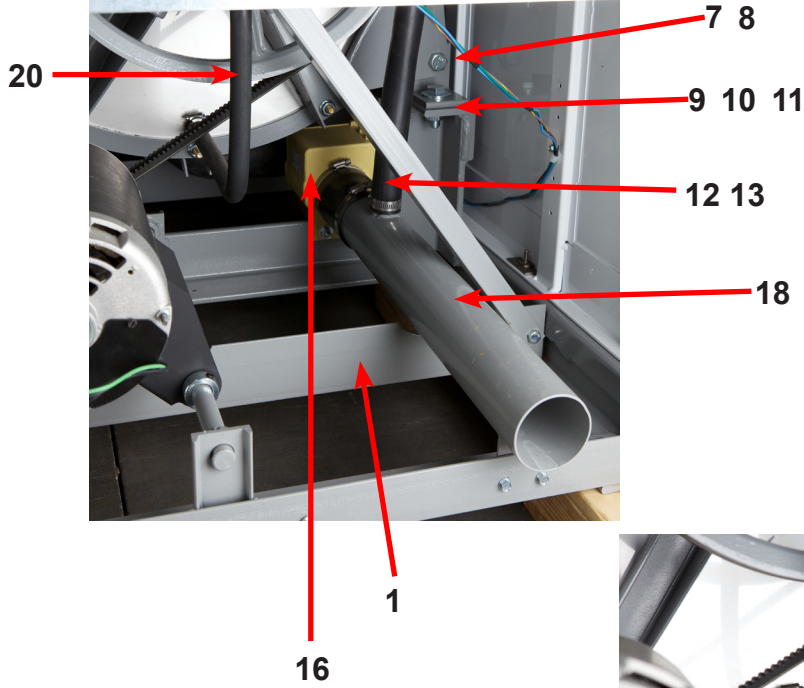
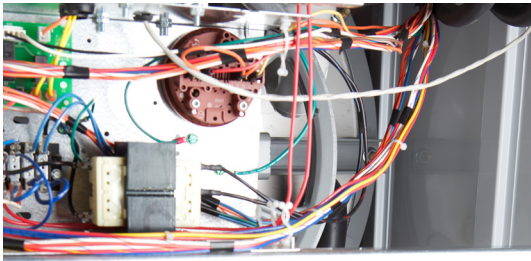

## WSVD Cylinder, Seals & Bearings

	Description	Part Number	Qty
*	Bearings and Seal Kit	9732-219-005	1
*	Housing, Bearing- Assembly (items #2-#6)	9803-186-001	1
2	Housing, Bearing	9241-180-002	1
3	Bearing, Front (LARGE)	9036-159-005	1
4	Bearing, Rear (SMALL)	9036-159-004	1
5	Spacer, Bearing	9538-167-001	1
6	Ring, Bearing Retainer	9487-238-003	1
7	Back Assy, Tub 2 piece	9732-137-003	1
8	Seal, Small	9532-140-003	1
9	Seal, Large	9532-140-009	1
10	Ring, Seal Mounting	9950-048-001	1
11	Tub Back Mating Ring	9487-261-003	1
12	Bolt 5/8-11x1 1/2" Tub end of bearing Housing	9545-060-001	6
12	Nut 5/8"-11	8640-425-001	6
12	Lockwasher 5/8"	8641-582-018	6
13	Support Arm Assy, Bearing Housing	9991-056-002	6
14	Bolt Pulley end of bearing housing, 7/16-14x2"	9545-059-003	6
*	Nut, Flange Locking 7/16"	8640-416-005	6
15	Pulley, Driven	9453-168-003	1
16	Ring, Tolerance	9487-234-003	1
17	Washer 5/8"x 2 1/4"	8641-581-032	1
18	Bolt 5/8-11x1 1/2"	9545-060-001	1
19	Lockwasher 5/8 Ext. tooth	8641-582-018	1
*	Cylinder Assy	9848-120-001	1
*	Tub and Cylinder Assy.	9869-034-001	1
*	Plastic Plug 1 1/2"-(inside cylinder)	9456-041-007	1

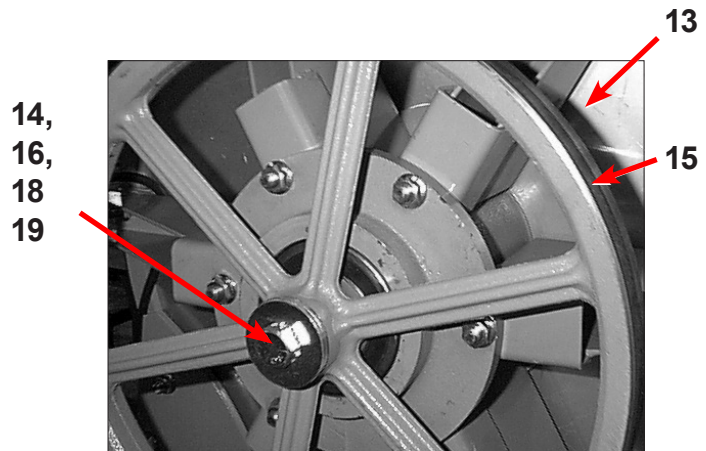
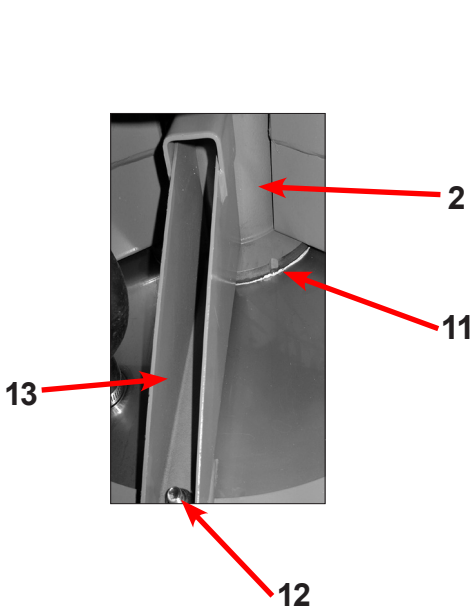
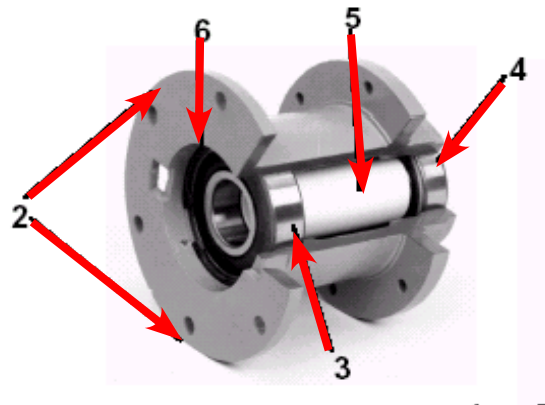
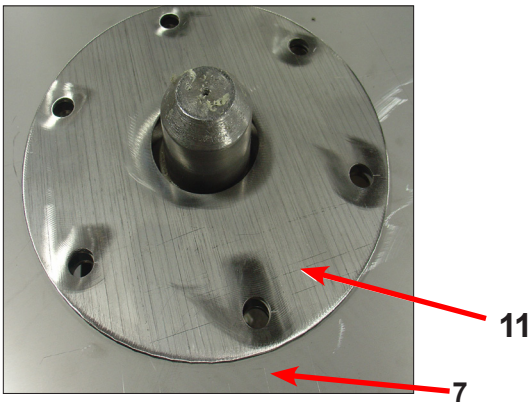
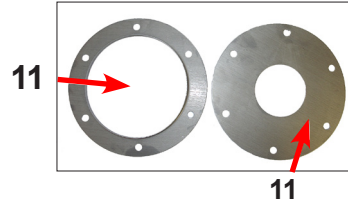
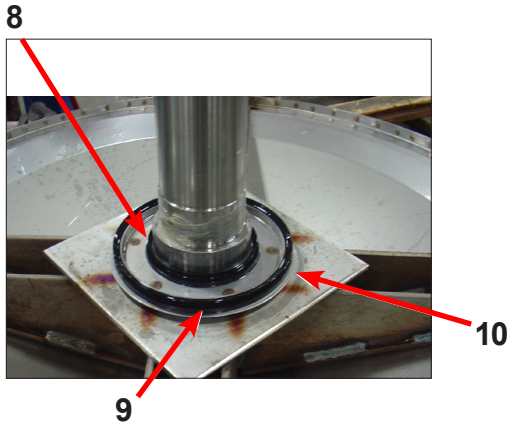
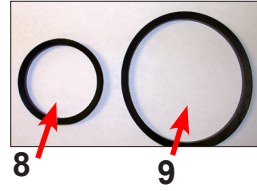
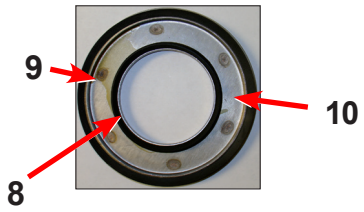



---

# Section 12:

## 50 Hz Washer

### Models

Parts in this section used only in these models. All other parts are same as standard 60 Hz pages.

# Transformers -21 Models

KEY	Part Description	WSAD30KCS-21CR	QTY
*	Wire Assembly -Orange/White	8220-001-235	1
*	Wire Assembly -Blue	8220-001-338	1
1	Transformer-120/18zVAC,5VA	8711-015-001	1
2	Transformer, Control	8711-004-002	1
3	Transformer, Secondary	8711-009-002	1
*	Wiringlabel-Schematic	9506-174-001	1
*	Wiringlabel-Diagram	9506-175-001	1
*	Controlsassembly -Trough	9857-156-005	1

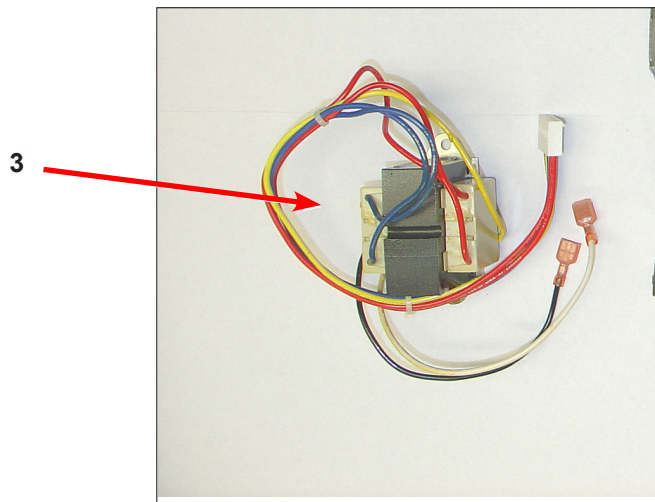
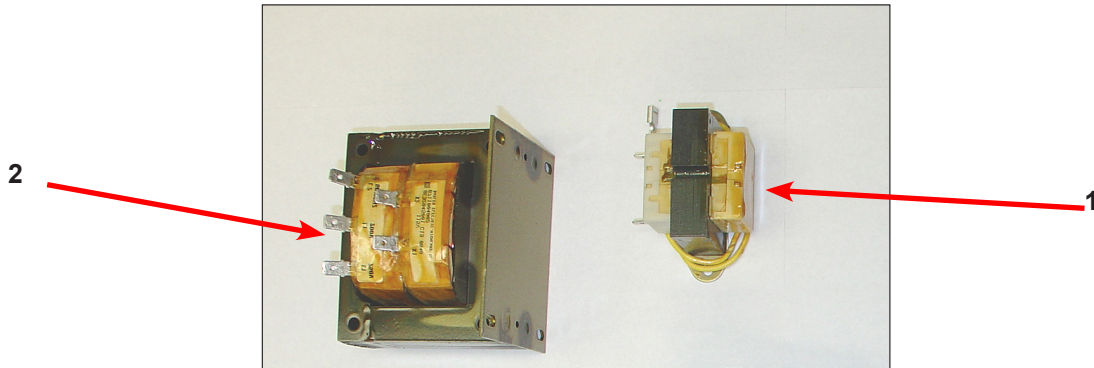

# Wiring Schematic for 50hz Washer -21CR

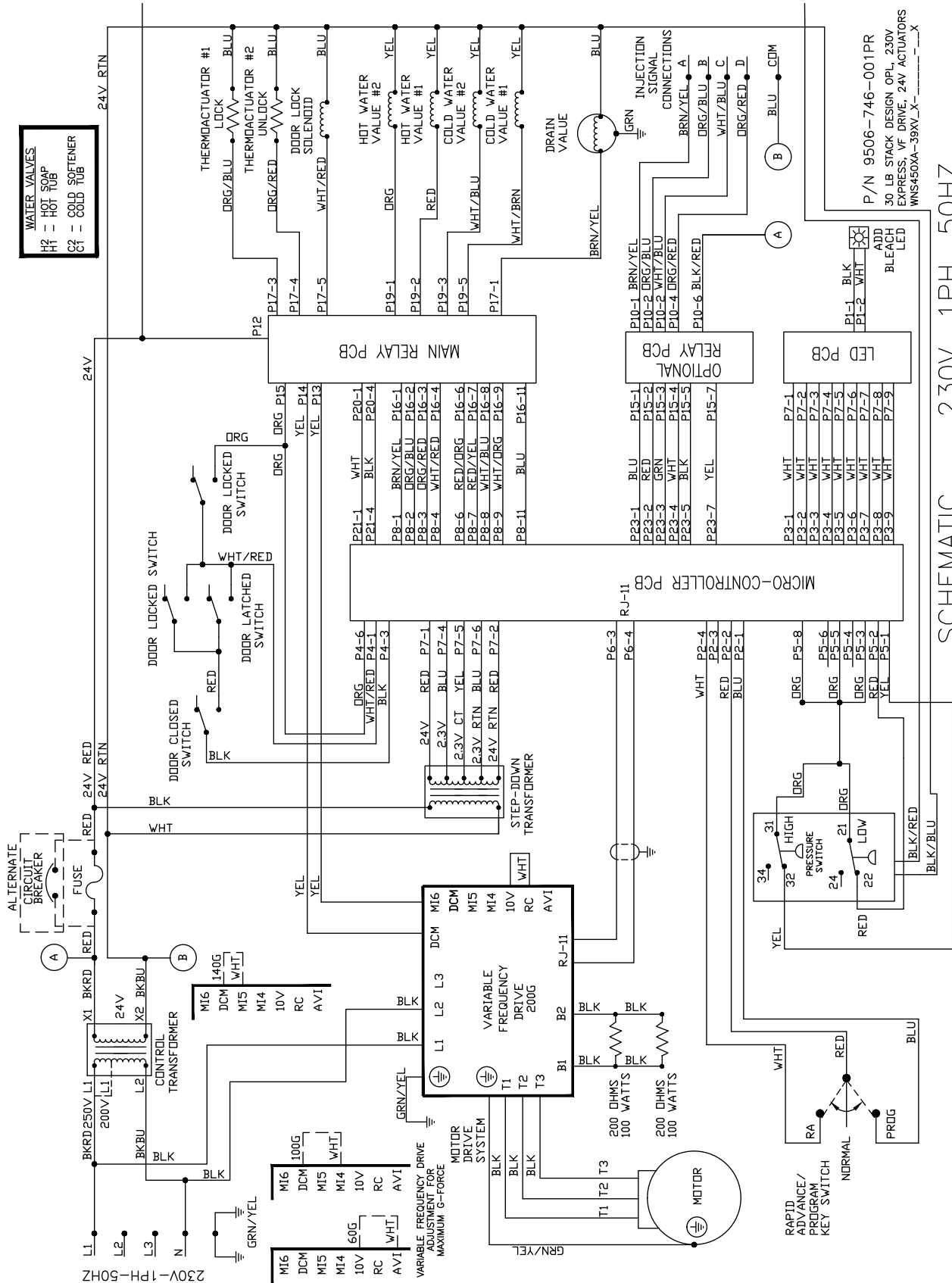

P/N 9506-746-001PR  
 30 LB STACK DESIGN OPL, 230V EXPRESS, VF DRIVE, 24V ACTUATORS  
 WNS450XA-39XV\_X-\_-\_-\_-X

SCHEMATIC 230V, 1PH, 50HZ

# Wiring Diagram for 50hz Washer - 21CR

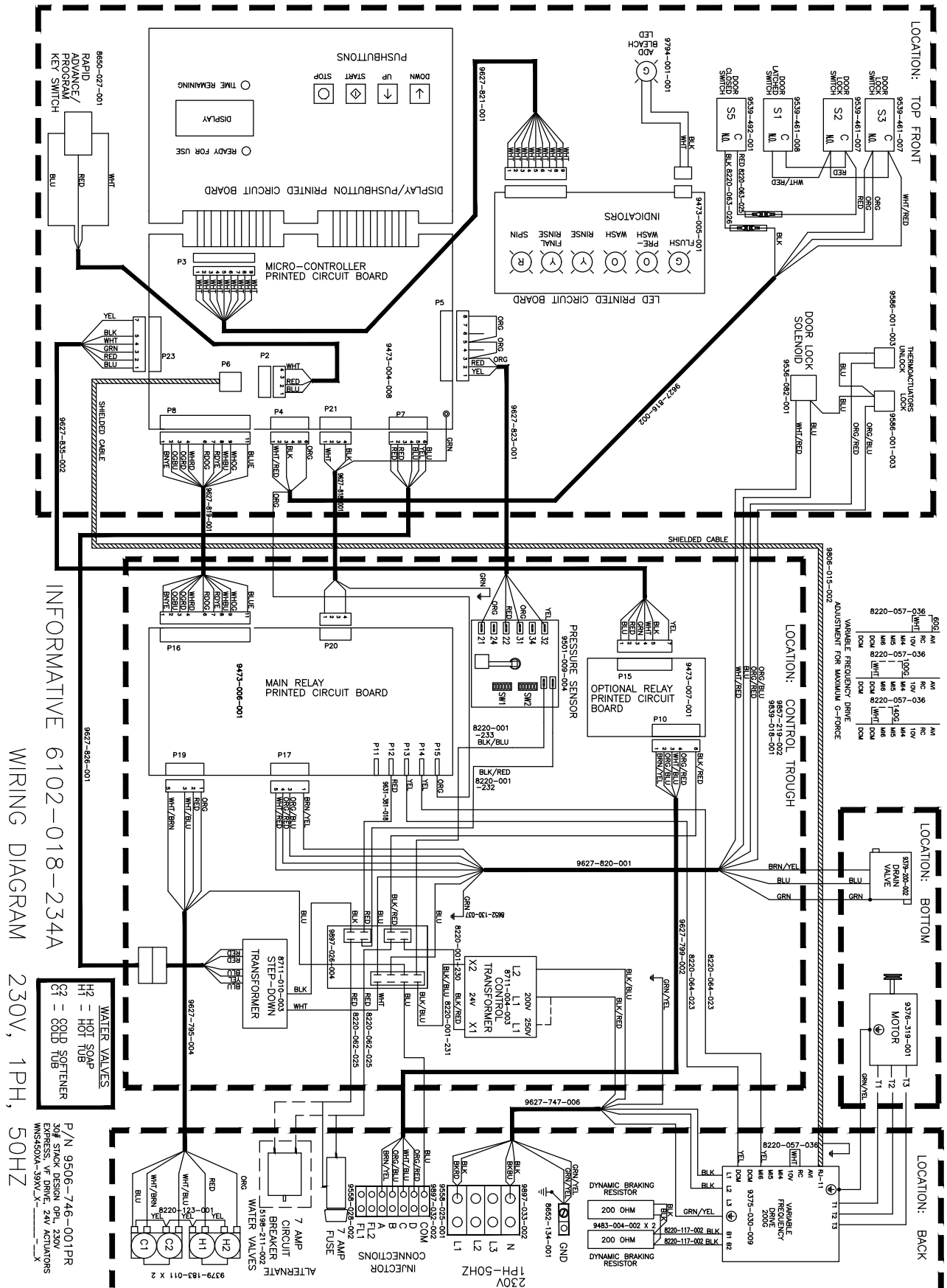

---

# **Section 13:**

## Maintenance

## Washer and Dryer

---

# Preventative Maintenance

## Daily

- Step 1:** Clean the lint screen free of lint and other debris. Use a soft brush and Hot water if necessary.
- Step 2:** Check the lint screen for tears. Replace if necessary.
- Step 3:** Clean lint from the lint screen compartment.
- Step 4:** Inspect felt seal on lint screen assembly, replace if needed.

## Monthly

- Step 1:** Remove lint accumulation from the end bells of the motor.
- Step 2:** Remove lint accumulation from front control area.
- Step 3:** Remove lint and dirt accumulation from the top of the dryer and all areas above, below, and around the burners and burner housing. Failure to keep this portion of the dryer clean can lead to a build-up of lint creating a fire hazard.
- Step 4:** Remove and clean coin acceptors. (Vended Models Only)

## Quarterly

- Step 1:** Check the belts for looseness, wear, or fraying.
- Step 2:** Inspect the gasket of the door glass for excessive wear.
- Step 3:** Check tightness of all fasteners holding parts to support channel.
- Step 4:** Check tightness of all set screws.
- Step 5:** Remove the air flow switch assembly and check the tumbler thru-bolts for tightness.
- Step 6:** Apply a few drops of oil to pivot pins and the tension arms where in contact with each other.

## Semi-Annually

- Step 1:** Remove and clean the main burners.
- Step 2:** Remove all orifices and examine for dirt and hole obstruction.
- Step 3:** Remove all lint accumulation. Remove the front panel and the lint screen housing and remove lint accumulation.

## Annually

- Step 1:** Check the intermediate pulley bearings for wear.
- Step 2:** Check and remove any lint accumulation from the exhaust system including recirculation chambers if applicable.
- Step 3:** Grease the bearings and the shaft of the intermediate pulley. Use an Alemite grease gun and Molykote BR2-S grease. (Where applicable)

---

# Preventative Maintenance

## Daily

- Step 1:** Check that the loading door remains securely locked and cannot be opened during an entire cycle.
- Step 2:** Clean the top, front, and sides of the cabinet to remove residue.
- Step 3:** Clean the soap dispenser and lid and check that all dispenser mounting screws are in-place and tight.
- Step 4:** Check the loading door for leaks. Clean the door seal of all foreign matter.
- Step 5:** Leave the loading door open to aerate the washer when not in use.

## Quarterly

- Step 1:** Make sure the washer is inoperative by switching off the main power supply.
- Step 2:** Check the V-belts for wear and proper tension.
- Step 3:** Clean lint and other foreign matter from around motor.
- Step 4:** Check all water connections for leaks.
- Step 5:** Check the drain valve for leaking and that it opens properly.
- Step 6:** Wipe and clean the inside of the washer and check that all electrical components are free of moisture and dust.
- Step 7:** Remove and clean water inlet hose filters. Replace if necessary.
- Step 8:** Check anchor bolts. Retighten if necessary.