

COMMERCIAL DRYER
MODEL T-50 SWD REVERSING VENDED
C-SERIES CONTROL, NATURAL GAS/LP HEATED

Original Instructions
For GB & IE



DEXTER.
LAUNDRY

OPERATOR'S MANUAL
INSTALLATION & OPERATION INSTRUCTIONS

The dryer will operate correctly in ambient temperatures of 5°C to 45°C, in relative humidity up to 50% at 40°C and above 50% when below 40°C, and at altitudes up to 1000m above sea level, must be transported and stored from -40°C to 140°C, and has been packaged to prevent damage from humidity, vibration, and shock. Take measures to avoid harmful effects of occasional condensation.

▲ WARNING: FIRE OR EXPLOSION HAZARD Failure to follow safety warnings exactly could result in serious injury, death or property damage.

Do not store or use petrol or other flammable vapours and liquids in the vicinity of this or any other appliance.

– WHAT TO DO IF YOU SMELL GAS

- Do not try to light any appliance.
- Do not touch any electrical switch; do not use any telephone in your building.
- Clear the room, building or area of all occupants.
- Immediately call your gas supplier from a neighbor's telephone. Follow the gas supplier's instructions.
- If you cannot reach your gas supplier, call the fire department.

– Installation and service must be performed by a qualified installer, service agency or the gas supplier.

You, the purchaser, must post in a prominent location instructions to be followed in the event the user smells gas. Consult your local gas supplier for procedure to be followed if the odour of gas is present.

Post the following "**For Your Safety**" caution in a prominent location:

FOR YOUR SAFETY

Do not store or use gasoline or other flammable vapours or liquids in the vicinity of this or any other appliance.

FOR YOUR SAFETY

THIS MACHINE IS FOR DRYING ONLY FABRICS WASHED IN WATER.

To avoid possibility of fire, including spontaneous combustion, do not dry oiled floor mops, items containing foam rubber or similarly textured rubberlike materials, or any material on which you have used a cleaning solvent or which contains flammable liquids or solids (such as petrol, kerosene, waxes, etc.) Fabric softeners, or similar products, should be used per the fabric softener instructions. Remove all objects from pockets such as lighters and matches.

This appliance can be used by children aged from 8 years and above and persons with reduced physical, sensory, or mental capabilities, or lack of experience and knowledge, if they have been given supervision or instruction concerning use of the appliance in a safe way and understand the hazards involved. Children shall not play with the appliance. Cleaning and user maintenance shall not be made by children without supervision. Children of less than 3 years should be kept away unless continuously supervised.













It is important that you read this Manual and retain it for future reference. For service or replacement parts, contact the distributor in your area or the manufacturer.

Dexter Laundry, Inc.
2211 West Grimes Avenue
Fairfield, Iowa 52556 USA

TABLE OF CONTENTS

	Page No.
Warnings about use and operation	2
Dryer Specifications	4
Dryer Dimensions	5-7
Installation and Operating Instructions	8
Dryer Shutdown	14
Description of Dryer Control	15
Operating Instructions	15
Programming the Dryer Control	16
Reversing Options	27
Servicing and Troubleshooting	28
Preventative Maintenance Instructions	28

WARNINGS ABOUT USE AND OPERATION

 <p>Caution! There are sharp edges on various sheet metal parts internal to the enclosure. Use safety consciousness when placing or moving your hands while working in the interior of this equipment.</p>	
 <p>Meaning: Do Not Enter This Equipment (or Space).</p>	 <p>Meaning: Do Not Step, Stand, or Sit on This Equipment.</p>
 <p>Meaning: Do Not Operate with Guards or Covers Removed.</p>	 <p>Meaning: High Voltage. Disconnect power before servicing.</p>
 <p>Meaning: Lock Out and Tag Out before servicing.</p>	 <p>Meaning: Burn Hazard. Do Not Touch Burner Housing or Main Burners. Allow these parts to cool before servicing.</p>
 <p>Meaning: Do Not Dry Items Containing Explosive Material.</p>	 <p>Meaning: Do Not Dry Items Containing Flammable Material.</p>
 <p>Meaning: Read Operators Manual.</p>	 <p>Meaning: Center of Gravity.</p>
 <p>Meaning: Left Point for Forklift or Hand Pallet Truck or Jack.</p>	 <p>Meaning: Right Point for Forklift or Hand Pallet Truck or Jack.</p>

DO NOT MODIFY THIS APPLIANCE. KEEP SHIELDS, GUARDS, AND COVERS IN PLACE. These safety devices are provided to protect everyone from injury.

It is **ABSOLUTELY ESSENTIAL** that the dryer be connected to a good earth connection. This is not only for personal safety, but is necessary for proper operation of the controller. Failure to do so will void the warranty of the controller.

WARNINGS ABOUT USE AND OPERATION continued





THIS DRYER IS EQUIPPED WITH A MANUALLY RESETTABLE OVER-TEMPERATURE THERMOSTAT located on the end of the burner housing above the gas valve. If the dryer ceases to operate, refer to your "Service Procedure and Parts Data" book for instructions.

CHECK THIS THERMOSTAT WHEN INSTALLING DRYER to assure it is not tripped. Impacts such as rough handling in shipment, may trip the thermostat. It may be reset by inserting a wooden (nonconductive) pencil or dowel through the bushing in the cover.

WARNING: Do not stop dryer before end of cycle time unless all items are quickly removed and spread out to dissipate heat.

DO NOT SPRAY AEROSOLS IN THE VICINITY OF THIS APPLIANCE while in it is operation.

THIS APPLIANCE SHALL NOT BE USED TO DRY OFF CLOTHES CONTAINING SOLVENTS OR DRY-CLEANING FLUIDS.

Misuse of Dryer	
	Do not use this Equipment for any purpose not described in this Manual.
	Do not operate this equipment without all guards and covers in place.
	Do not operate this dryer from any power source not matching the operational requirements on the back of the dryer.
	Do not place your body inside the dryer cylinder or allow others to do so. Death or serious injury can result from this!
Other Examples May Be Applicable	



Caution – Replace Fuses With Same Type and Rating

Fuse No.	Voltage	Amperage	SC I/R	Type	Size
F1	250V	2.5A	100A@250VAC	F	¼ x 1¼ in. (6.35 x 31.75 mm)
F2	250V	1.5A	100A@250VAC	F	¼ x 1¼ in. (6.35 x 31.75 mm)

SPECIFICATIONS

50 lb. Commercial Dryer: T-50 SWD Reversing Tumbler DCS050ND-59CC2R

Cabinet Height	41 in.	1041 mm.
(Assumes minimum leveling leg adjustment)		
Cabinet Width	34 1/2 in.	876 mm.
Overall Depth	56 3/4 in.	1441 mm.
Floor to Bottom of Door	7 3/4 in.	196 mm.
Door Opening	25 5/8 in.	651 mm.
Dry Wt. Capacity	50 lbs.	22.7 kg.
Cylinder Diameter	32 1/2 in.	825 mm.
Cylinder Depth	33 in.	838 mm.
Cylinder Volume	15.8 cu. ft.	447.4 liters
Lint Screen Area	544 sq. in.	3510 sq. cm.
Gas Input	96,500 Btu/hr	28.3 kW
Gas Supply Connection	1/2 in.	12.7 mm.
Natural Gas Supply (Water Column)	5-8"	127 mm. - 203 mm.
Natural Burner Manifold (Water Column)	3.5 in.	88.9 mm
L.P. Supply (Water Column)	11.5- 13.5 in.	292 mm- 343 mm
L.P. Burner Manifold Pressure (Water Column)	10 in.	254 mm
Exhaust Size	8 in.	203 mm.
Make-up Air	1 sq. ft.	929 sq. cm.
Example: 1.5 sq. ft = 1.5 ft. long X 1 ft. wide		
Motor Size-Tumbler	2 H.P.	1.49 kW
Motor Size-Blower	1/2 H.P.	.373 kW
Airflow	510 CFM	14.4 m ³ /min

Electrical Specifications – 230/50/1

Voltage/Hz/Phase	230V/50Hz/1Phase
Running Amps	10
Circuit Protection Amps	15
Wire Size	3.5 mm ²
Electrical Service	2 wire + ground

Shipping Weight	540 lbs.	245 kg.
Net Weight	500 lbs.	227 kg.
Clearance Behind Machines (min.)	18 in.	457 mm.

T-50 SWD DRYER DIMENSIONS – FRONT VIEW inches (mm)

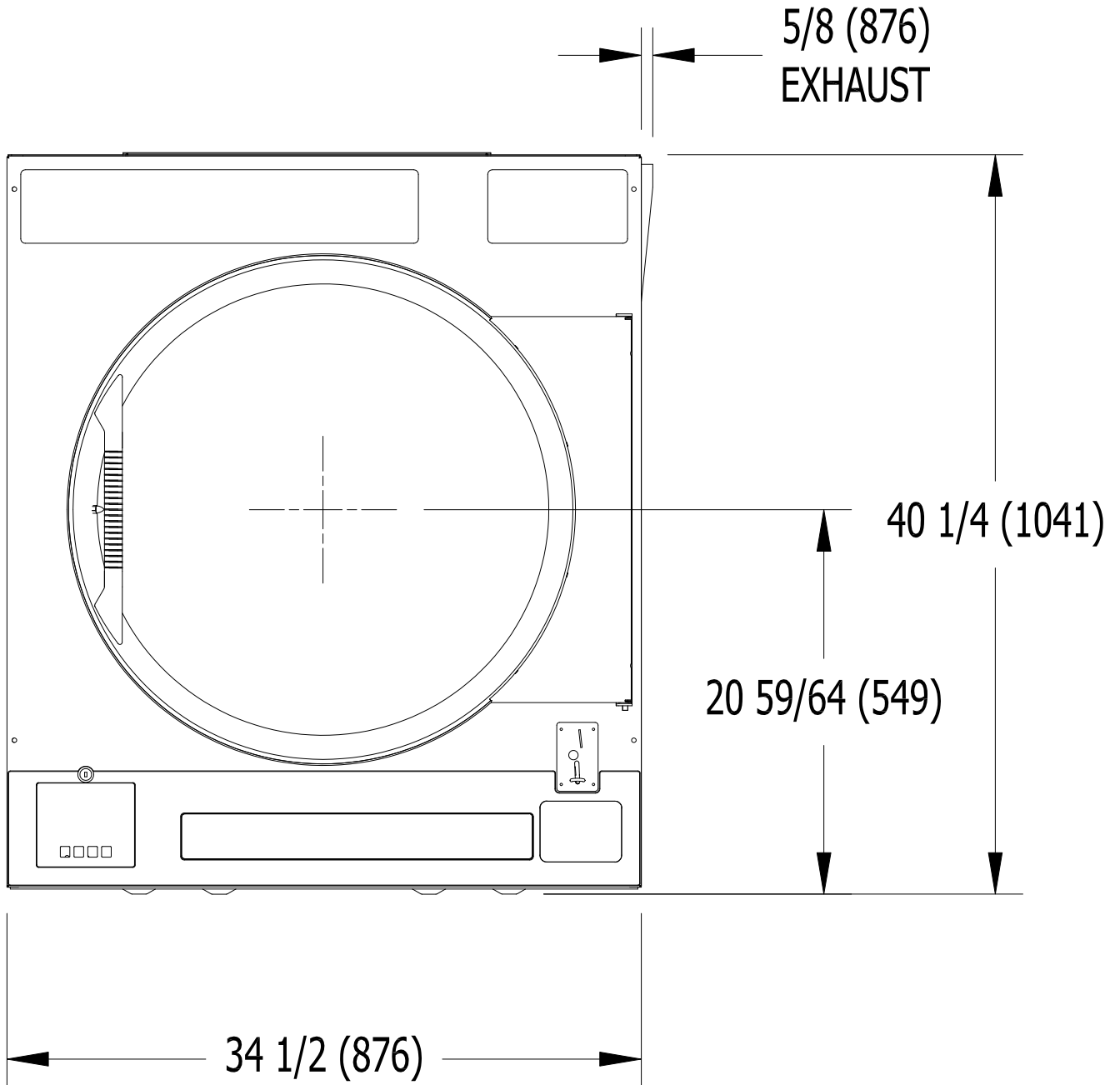

T-50 SWD DRYER DIMENSIONS – SIDE VIEW inches (mm)

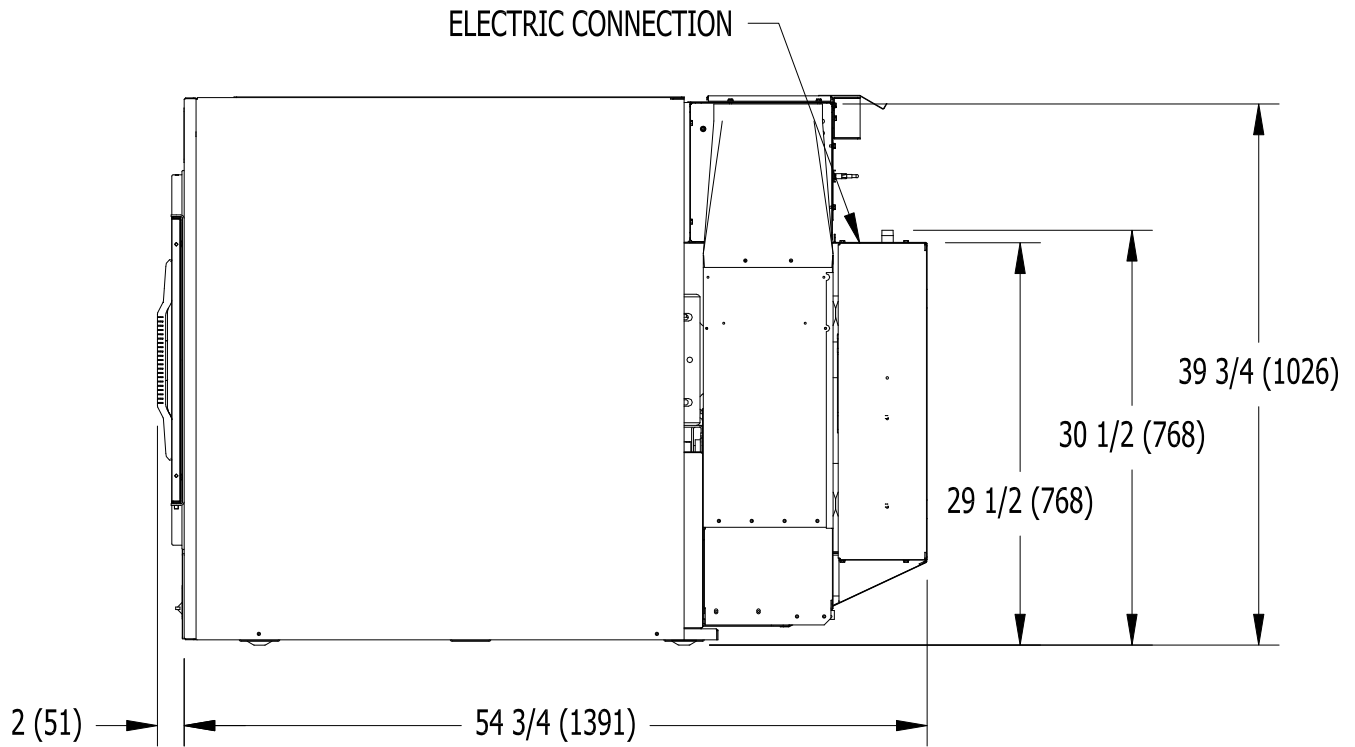

T-50 SWD DRYER DIMENSIONS – TOP VIEW inches (mm)

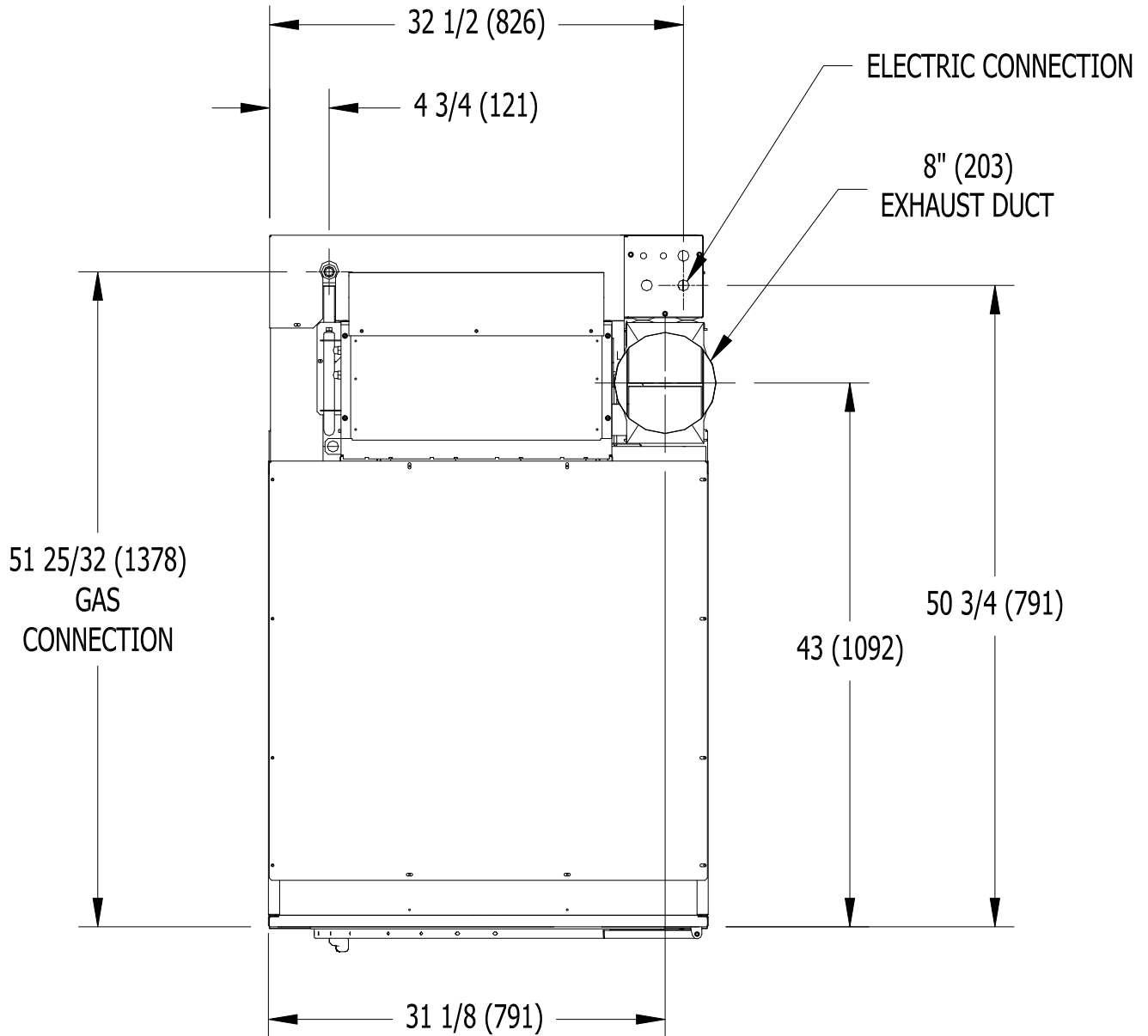

INSTALLATION AND OPERATING INSTRUCTIONS

Note: Before installation, check that the local distribution conditions, nature of gas and pressure, and the adjustment of the appliance are compatible.

Note: A forklift, or a hand pallet truck or jack, must lift the dryer and only from the front or rear of the dryer with the washer bolted to the pallet and supported the full length of the dryer.

UNCRATING

Tools required: 3/4 in. (19 mm) hex socket and ratchet driver, knife, and groove-joint pliers that opens to 1 3/8 in. (35 mm).

1. Remove the plastic wrap with the knife. Remove the cardboard rails, the fillers and the top cap.
2. Using a ratchet driver and a 3/4 in. (19 mm) hex socket, remove the (4) bolts attaching the wooden skid to the dryer cabinet. Save the bolts for future moving of the dryer.
3. With a walking motion, move the dryer forward completely off the wooden skid. Save the skid for future moving of the dryer.

Note: If the dryer is ever moved again, the dryer should be re-mounted on its pallet and its crating bolts re-inserted and tightened, in the reverse order as above.

DRYER ONLY INSTALLATION

1. Using the groove-joint pliers, install the leveling legs where the shipping bolts were removed when the shipping bolts held the skid.

STACK WASHER / DRYER INSTALLATION

1. Place the dryer on the top of the washer and align with the (4) mounting holes. The front (2) mounting holes are located inside the lint compartment 5½ in. (140 mm) from the front of the machine. The back (2) mounting holes are located on the right/left side of the machine, at the base of the back panel. Removing the rear guard is necessary to access the back mounting hole located opposite the duct work.
2. Use the (4) supplied 5/16 in. (8 mm) x 1-1/4 in. (32 mm) dog tip bolts to secure the dryer on the top of the washer.

DRYER INSTALLATION

This appliance must be installed in accordance with the rules in force and used only in a sufficiently ventilated space. Consult instructions before installation of this appliance.

1. CODE CONFORMITY. All commercial dryer installations must conform to local and the national codes for the location of the installation and the venting requirements.

The appliance must not be installed behind a lockable door, a sliding door or a door with a hinge on the opposite side to that of the tumble dryer, in such a way that a full opening of the tumble dryer door is restricted.

2. INSTALLATION CLEARANCES. This unit may be installed at the following alcove clearance. (millimeters)

- | | |
|----------------|---|
| I. Left Side | 0 in. |
| II. Right Side | 0 in. * |
| III. Back | 18 in. (457) (Certified for 1 in. (25) clearance; however, 18 in. (457) clearance is necessary behind the belt guard to allow servicing and maintenance.) |
| IV. Front | 48 in. (1220) (to allow use of dryer) |
| V. Top | Refer to figure on the next page labeled "Vertical Clearance Dimensions". Certification allows 0 in. clearance for wall framing at the top 18 in. (456) back from the front. However, a 1/4 in. (6) clearance should be allowed in case the dryer needs moving. |
| VI. Floor | This unit may be installed upon a combustible floor. |

Do not obstruct the flow of combustion and ventilation air.

Maintain minimum of 1 in. (25mm) clearance between duct and combustible material.

Refer to the installation label attached to the Belt Guard on the rear of the dryer for other installation information and start-up information.

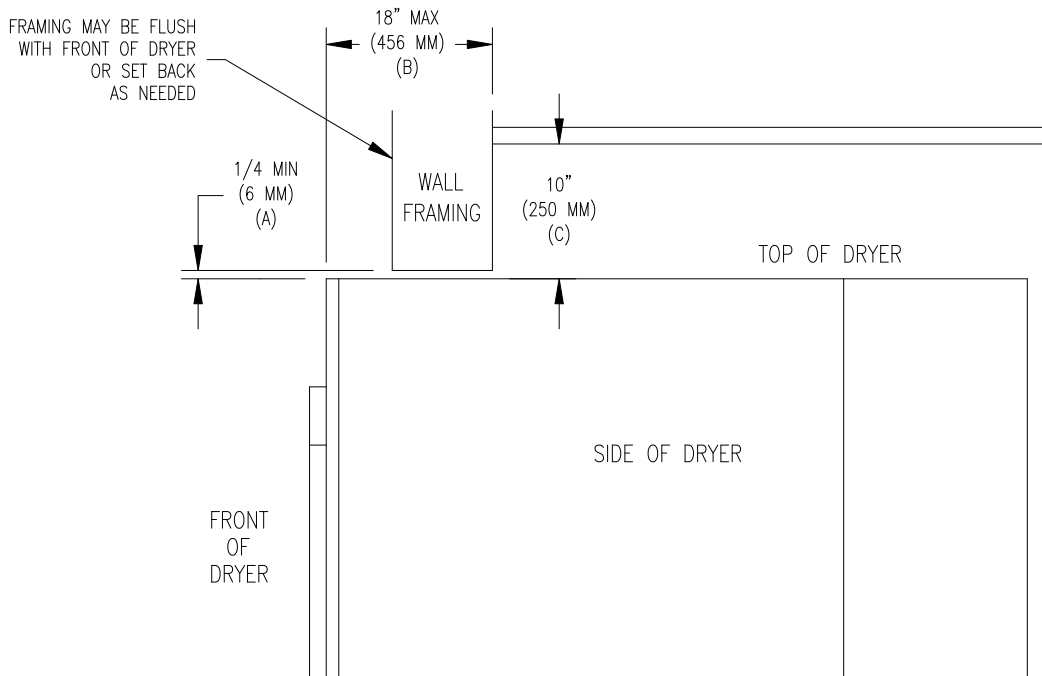

VERTICAL CLEARANCE DIMENSIONS

3. MAKE-UP AIR. Adequate make-up air 14.4 m³/min (510 CFM) must be supplied to replace air exhausted by dryers on all types of installations. Provide a minimum of 929 cm² (1 sq. ft.) make-up air opening to outside for each dryer. This is a net requirement of effective area. Screens, grills or louvers, which will restrict the flow of air, must be considered. Consult the supplier to determine the free area equivalent for the grill being used. The source of make-up air should be located sufficiently away from the dryers to allow an even airflow to the air intakes of all dryers. Multiple openings should be provided.

NOTE: The following considerations must be observed for gas dryer installations where dry cleaners are installed. The sources of all make-up air and room ventilation air movement to all dryers must be located away from any dry cleaners. This is necessary so that solvent vapours will not be drawn into the dryer inlet ducts. Dry cleaner solvent vapours will decompose in contact with open flame such as the gas flame present in clothes dryers. The decomposition products are highly corrosive and will cause damage to the dryer(s) ducts and clothes loads.

The operation of this appliance may affect the operation of other types of gas appliances, which take their air for safe combustion from the same room. Adequate ventilation must be provided to avoid back flow of gasses from other appliances in the same room. All other gas appliances should be tested with the Dexter dryer in operation and all the windows and doors closed. If in doubt, consult the appliance manufacturer(s).

4. ELECTRICAL REQUIREMENTS. The electrical installation must be performed by a qualified electrical technician.

The electrical power requirements necessary to operate the unit satisfactorily are listed on the serial plate located on the back panel of each dryer and in the specifications section of this manual. The electrical connections should be made to the terminal board, in the electrical control box on the rear of the unit using copper conductors of 15A minimum capacity. A 22 mm (7/8 in.) hole is provided for the connection of conduit for the power supply conductors. It is absolutely necessary that the dryer be connected to a known earth. Individual circuit breakers for each dryer are required. Introduction of supply wiring must not increase the Ingress Protection (IP) rating.

The installation must meet the National Electrical Requirements of the country, state, or locality of installation. Individual 15 A circuit breakers for each dryer are required. The installer must provide a disconnect switch which

will interrupt both lines. It may be a local or national requirement to provide an electrical interruption switch visible and accessible from the room in which the dryer is installed. The wiring diagram is located in the rear control box on the back of the dryer.

For destination countries where CE requirements must be met, individual 230V supply disconnecting devices for each dryer are required and must be one of the following types:

- a. switch-disconnector with fuses per IEC 60947-3 utilization category AC-23B;
- b. disconnector with fuses per IEC 60947-3 having an auxiliary contact that in all cases causes switching devices to break the load circuit before the opening of the main contacts of the disconnector;
- c. a circuit-breaker suitable for isolation per IEC 60947-2;
- d. any other switching device in accordance with an IEC product standard for that device and which meets the isolation requirements of IEC 60947-1 as well as a utilization category defined in the product standard as appropriate for on-load switching of motors or other inductive loads;

The supply disconnecting devices must

- a. provide a means allowing the supply disconnecting devices to be locked in the OFF position;
- b. be mounted 0.7 m to 1.7 m above the floor, within 2 m from the dryer, and within 8 m from the operator position;
- c. have a red actuator to indicate that it serves a dual Emergency Stop function;
- d. be rated for branch circuit operation;
- e. be approved for use in the country where installed;

CONTROL TRANSFORMER CONNECTIONS Adjustment for different voltages of supply mains.

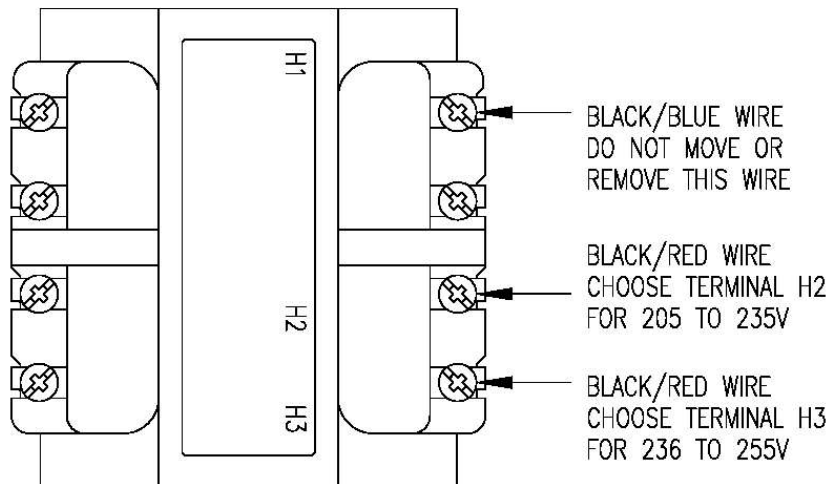

IMPORTANT: TRANSIENT VOLTAGE SURGE SUPPRESSORS

Like most electrical equipment, your new machine can be damaged or have its life shortened by voltage surges due to lightning strikes which are not covered by factory warranty. Local power distribution problems also can be detrimental to the life of electrical components. We recommend the installation of transient voltage surge suppressors for your new equipment. These devices may be placed at the power supply panel for the complete installation and don't require an individual device for each machine.

These surge protectors help to protect equipment from large spikes and also from small ongoing spikes in the power that occur on a day to day basis. These smaller surges can shorten overall life of electrical components of all types and cause their failure at a later date. Although they can't protect against all events, these protective devices have a good reputation for significantly lengthening the useful life of electronic components. Electronic components are helped to have a longer useful life when they are supplied with the clean stable electrical power they like.

5. GAS REQUIREMENTS. The complete gas requirements necessary to operate the dryer satisfactorily are listed on the serial plate located on the back panel of the dryer and in the specifications section of this manual. This appliance is adjusted for a G20 gas supply; please refer to the table below for country and regulator setting.

NATURAL GAS FOR DCS050ND-59CC2R

NOMINAL HEAT INPUT Q_n	96500 BTU/HR (28.3 kW) MAX
GAS FLOW RATE	2.5 m ³ PER HOUR
BURNER PRESSURE	3.5 in. H ₂ O (8.7 mbar)(0.87 kPa)
INJECTOR SIZE	0.1285 in. (3.26 mm)

ADJUSTMENT REQUIRED PER COUNTRY

COUNTRY	CATEGORY	SUPPLY PRESSURE mbar (Normal / Minimum / Maximum)	REGULATOR SETTING mbar (kPa) (Designation)
BG, LV	I 2H	(20 / 17 / 25)	8.7 (0.87) (G20)
HU	I 2H	(25 / 18 / 33)	8.7 (0.87) (G20)
LU	I 2E	(20 / 17 / 25)	8.7 (0.87) (G20)
CY, DK, EE, FI, HR, IT, LT, NO, RO, SE, SI, SK, TR	II 2H3B/P	(20 / 17 / 25) / (30 / 25 / 35)	8.7 (0.87) (G20) / 22.4 (2.24) (G30)
AT, CH, SK	II 2H3B/P	(20 / 17 / 25) / (50 / 42.5 / 57.5)	8.7 (0.87) (G20) / 22.4 (2.24) (G30)
CH, CZ, ES, GB, GR, HR, IE, IT, LT, PT, SI, SK	II 2H3P	(20 / 17 / 25) / (37 / 25 / 45)	8.7 (0.87) (G20) / 22.4 (2.24) (G31)
NL	II 2L3B/P	(25 / 20 / 30) / (30 / 25 / 35)	12.2 (1.22) (G25) / 22.4 (2.24) (G30)
RO	II 2L3B/P	(20 / 17 / 25) / (30 / 25 / 35)	12.2 (1.22) (G25) / 22.4 (2.24) (G30)
NL	II 2L3P	(25 / 20 / 30) / (37 / 25 / 45)	12.2 (1.22) (G25) / 22.4 (2.24) (G31)
NL	II 2L3P	(25 / 20 / 30) / (50 / 42.5 / 57.5)	12.2 (1.22) (G25) / 22.4 (2.24) (G31)
RO	II 2E3B/P	(20 / 17 / 25) / (30 / 25 / 35)	8.7 (0.87) (G20) / 22.4 (2.24) (G30)
PL	II 2E3B/P	(20 / 17 / 25) / (37 / 25 / 45)	8.7 (0.87) (G20) / 22.4 (2.24) (G30)
DE	II 2E3B/P	(20 / 17 / 25) / (50 / 42.5 / 57.5)	8.7 (0.87) (G20) / 22.4 (2.24) (G30)

The inlet gas connection to the unit is ISO 7-RC 3/4 thread. The connection to the appliance shall be made with a flexible hose suitable for the appliance category in accordance with national installation regulations. The size of the piping to supply the dryer should be determined by reference to the national installation practice and consultation with the local gas supplier.

An individual gas shutoff valve is recommended for each dryer and may be required by local code (not supplied).

A joint compound resistant to the action of all gases should be employed in making pipe connections.

A drip tee should be provided in the gas piping entering the unit to catch dirt and other foreign articles.

All pipe connections should be checked for leakage with soap solution. Never check with an open flame.

The recommended natural gas supply pressure is 7 inches water column (17.8 cm) at each dryer.

Note: There are two 9 mm pressure taps, one at the inlet side, one at the outlet side of the gas valve, for use, if it is necessary, to check either pressure.

PRESSURE REGULATOR ADJUSTMENT

Adjustments should be made by qualified personnel only.

1. With the dryer off, unscrew the outlet pressure tap on the gas control valve a half turn and slip a pressure gauge tube over the nipple. Ensure that screw is retightened after the regulator is adjusted.
2. Remove the regulator cap screw to expose the regulator adjustment screw.
3. Start the dryer. Using a screwdriver, slowly turn the adjustment screw until the required burner pressure is indicated on the pressure gauge. Turn the adjustment screw clockwise to increase and counter-clockwise to decrease the gas pressure to the burner. Turn dryer off.
4. Replace the pressure regulator cap screw.
5. Remove the pressure gauge and retighten the pressure tap screw.

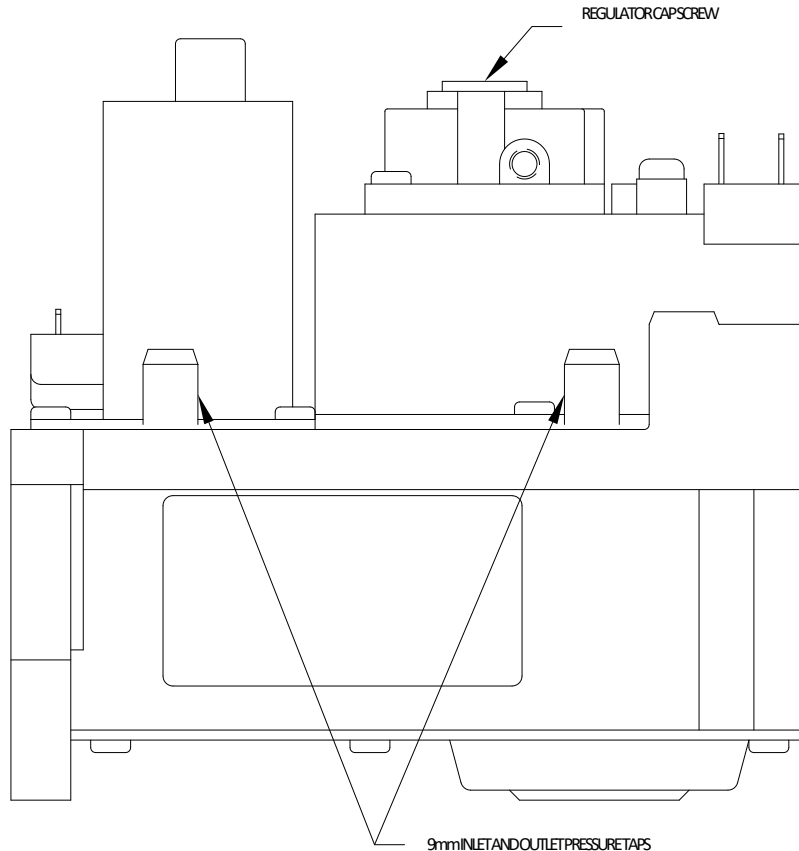

For altitudes above 610m (2,000 feet), it is necessary to de-rate the BTU input. Contact your local distributor for instructions.

L.P. gas conversion kits are available for this dryer. Contact your local distributor.

CAUTION: The dryer must be disconnected from the gas supply piping system during any pressure testing of that system at test pressures in excess of 1/2 psig (35 mbar). The dryer must be isolated from the gas supply piping system during any pressure testing of the gas supply piping system at test pressures equal to or less than 1/2 psig (35 mbar).

6. EXHAUST INSTALLATION. Exhausting of the dryer(s) should be planned and constructed so that no air restrictions occur. Any restriction due to pipe size or type of installation can cause slow drying time, excessive heat, and lint in the room.

From an operational standpoint, incorrect or inadequate exhausting can cause a cycling of the high limit thermostat which shuts off the main burners and results in inefficient drying.

The exhaust duct connection near the top of the dryer will accept a 203 mm (8 in.) round duct. Individual exhausting of the dryers is required. All heat, moisture, and lint should be exhausted outside by attaching a pipe of the proper diameter to the dryer adapter collar and extending it out through an outside wall. This pipe must be very smooth on the inside, as rough surfaces tend to collect lint which will eventually clog the duct and prevent the dryer from exhausting properly. All elbows must be smooth on the inside. All joints must be made so the

exhaust end of one pipe is inside the next one downstream. The addition of an exhaust pipe tends to reduce the amount of air the blower can exhaust. This does not affect the dryer operation if held within practical limits. For the most efficient operation, it is recommended that no more than 4.25m (14 ft.) of straight 203mm (8 in.) diameter pipe with two right angle elbows be used for each cylinder. The design of the vent system shall be such that any condensate formed when operating the dryer from cold shall either be retained and re-evaporated or discharged.

Maintain minimum 25mm (1 in.) clearance between duct and combustible material.

If the exhaust pipe passes through a wall, a metal sleeve of slightly larger diameter should be set in the wall and the exhaust pipe passed through this sleeve. This practice is required by some local codes and is recommended in all cases to protect the wall. This type of installation should have a means provided to prevent rain and high winds from entering the exhaust when the dryer is not in use. A hood with a hinged damper can be used for this purpose. Another method would be to point the outlet end of the pipe downward to prevent entrance of wind and rain. In either case, the outlet should be kept clear, by at least 610 mm (24 in.), of any objects which would cause air restriction.

Never install a protective screen over the exhaust outlet.

When exhausting a dryer straight up through a roof, the overall length of the duct has the same limits as exhausting through a wall. A rain cap must be placed on top of the exhaust and must be of such a type as to be free from clogging. The type using a cone shaped "roof" over the pipe is suitable for this application.

Exhausting the dryer into a chimney or under a building is not permitted. The exhaust air should not be vented into a wall, a ceiling, or a concealed space of building. In these cases, there is a danger of lint buildup which can be highly combustible.

NOTE: Exhaust air must not be discharged into a flue which is used for exhausting fumes from appliances burning gas or other fuels.

Caution - A clothes dryer produces combustible lint and should be exhausted outdoors. The area around the clothes dryer should be kept free of lint.

7. DRYER IGNITION (SOLID STATE IGNITION). The solid-state ignition system lights the main burner gas by spark. The gas is ignited and burns only when the gas-relay (in the electronic controller) calls for heat. The procedure for first-time starting of a dryer is as follows:

- i. First, review and comply with the "WARNINGS ABOUT USE AND OPERATION" found on the inside front cover of this manual. The dryer **MUST** be properly earthed.
- ii. Make sure all gas supply lines are purged of air. Close the main gas shut-off valve and wait for five minutes before turning the valve back on.
- iii. Turn on the main electrical power switch. The dryer may be started by following the "OPERATING INSTRUCTIONS" found later in this manual.
- iv. Natural gas and liquefied petroleum gas fired dryers both operate in the same manner. When the gas-valve relay contacts are closed (indicating a demand for heat), the solid-state ignition control will automatically supply energy to the redundant gas valve after a 15 second pre-purge. Spark will continue until a flame is detected by the sensing probe, but not longer than 4 seconds. If the gas fails to ignite within 4 seconds, the gas valve closes and the gas system will "lock out". No further attempts at ignition will be performed automatically. It is then necessary to interrupt electrical power to the ignition system before making another attempt to light the burners. This can be done by opening the dryer door, allowing the dryer to come to a stop for 15 seconds, closing the door, and pushing the "Start"  button. The dryer will then repeat the ignition trial cycle.

8. MAIN BURNER ADJUSTMENT. The primary air shutter of each main burner must be properly adjusted for the correct air-gas ratio. Loosen the shutter locking screw. Adjust the shutter by closing it sufficiently to give a blue flame with a yellow tip. Next, open the shutter until the yellow tips are at a minimum. After adjustment, securely lock each shutter in position by tightening the shutter locking screws.

NOTE: The A-weighted emission sound pressure level does not exceed 70dB(A). The operator does not need hearing protection.

NOTE: The dryer does not emit hazardous radiation.



WARNING: To avoid potential risks of spontaneous combustion of a load, remove the load quickly after the completion of the cycle or in case of failure of power supply.



DANGER: Do not dry loads which may create an explosive atmosphere in the dryer.

DRYER SHUTDOWN

To render the dryer inoperative, turn off the main gas shut-off valve and disconnect the electrical power supply to the dryer.

THE INSTALLER MUST TEST THE DRYER FOR OPERATION AND INSTRUCT THE USER BEFORE LEAVING THE INSTALLATION.

DESCRIPTION OF DRYER CONTROL

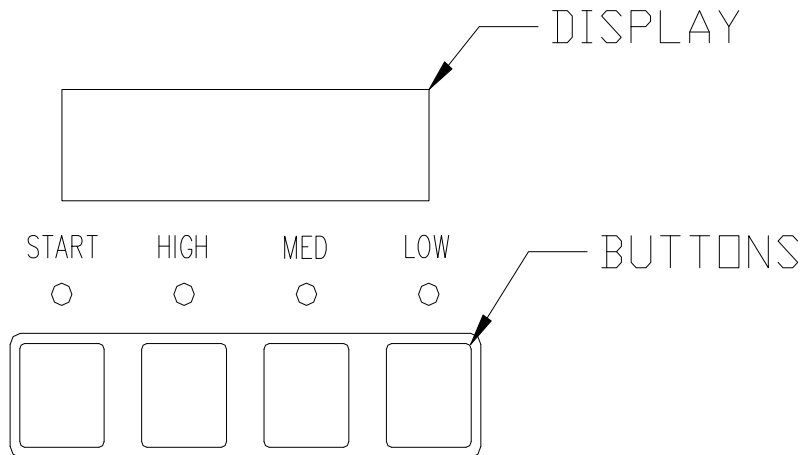

OPERATING INSTRUCTIONS

STARTING THE DRYER

1. The display on the dryer control will show the required vend amount when in idle mode. Once the door is opened, it will prompt the user to add money. Load clothes into the dryer. Close the door completely.
2. Deposit coins equal to or greater than the displayed vend price. The display on the control will prompt the user to choose a drying temperature.
3. Select the drying temperature by pressing the appropriate button for "high", "med" (medium) or "low". This will turn on the red indicator light showing the selected temperature.
4. Press the "start" button to start dryer. This will turn on the green indicator light. The drying time purchased is now displayed. The colon begins flashing to indicate that the timer is counting down.

RUNNING THE DRYER

-Opening the door will stop the dryer, but the timer will continue to count down. The dryer will restart, if time has not expired, upon closing the door and pressing the "start" button.

-Selected temperature may be changed at any time (unless Temperature Pricing feature is activated).

-Running time may be extended by depositing coins and pressing the "start" button. Unless time has expired, the controller will accept coins whether or not the original vend price is equaled.

-If time has run out, the dryer must be restarted as if it was at the beginning of drying the load, which requires meeting or exceeding the vend price.

-Clothes should be removed promptly after the cycle is completed to prevent excessive wrinkling.

-Cool-down time (owner programmable) is always part of the cycle time to prevent damage from heat and is purchased by the customer. For example, if the cool-down time is 2 minutes, then the last 2 minutes of the cycle will have no heat.

PROGRAMMING THE DRYER CONTROL

The dryer control can be programmed to prompt the user for alternate vend prices, change dryer cycle times, temperatures and many other options. This can be accomplished in two ways:

1. Manual programming utilizing the "Start", "High", "Medium" and "Low" buttons for the dryer.
2. USB download of a customizable User File. For instructions on using the USB download feature, please contact your local Dexter distributor or visit DexterLive.com.

MANUAL PROGRAMMING:



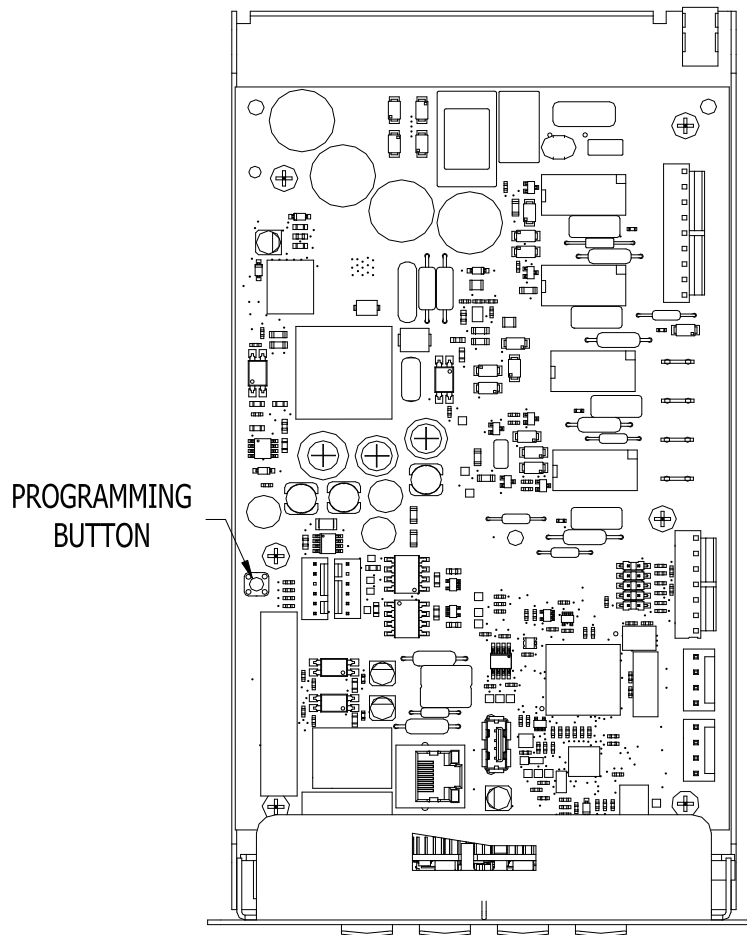

The dryer must be in idle mode for the manual programming menus to be accessed. Idle mode is when the dryer is not actively running a drying cycle and the vend price is displayed on the screen.

To enter the manual programming mode, the control tray on the dryer must be unlocked and pulled out to reveal the programming button. The programming button is then pressed for 1 second. The control should display "DRYER PROGRAMMING".

See the figure below for the location of the programming button on the control tray.



When manual programming mode is entered, the "Start", "High", "Medium" and "Low" buttons perform alternate functions.

Button Name	Alternate Function in Programming Mode
Start 	Becomes the action to accept the displayed option or the "Enter" key
High 	Becomes the action to move UP through displayed options (Press & hold for accelerated scrolling)
Medium 	Becomes the action to move DOWN through displayed options (Press & hold for accelerated scrolling)
Low 	Becomes the action to move back a step (1 press) or EXIT from programming mode (press for 3 seconds)

These alternate functions allow the user to move through a menu of options to choose various programmable settings. The figure below shows the top level menu. Choosing an option from the top level menu will then display the next level of options (the sub menu).

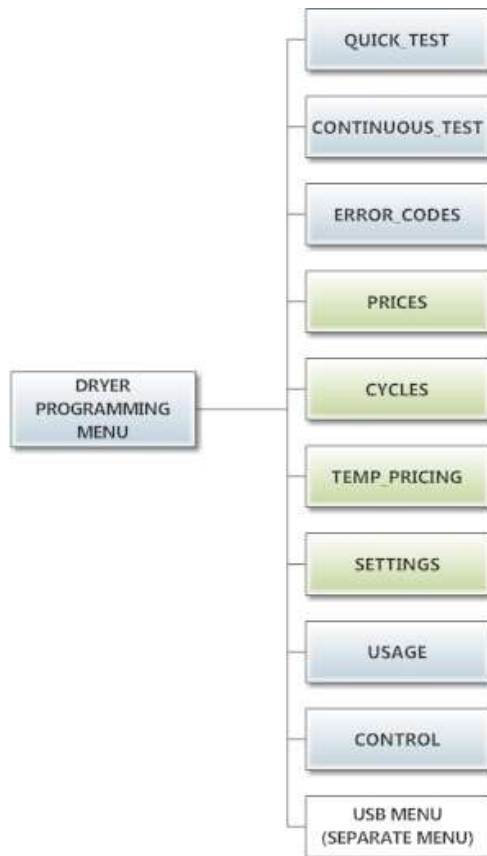

Quick Test Option:

When the Quick Test Option is chosen, the dryer will begin a shortened dry cycle without the displayed vend price being met. The purpose of this shortened cycle is to test all major components for proper operation. Error Codes should all function normally during this test. The display will show customer prompts in a similar way to a normal dry cycle.

Continuous Test Option:

Similar to the Quick Test, when the Continuous Test Option is chosen, the dryer will begin a dry cycle without the displayed vend price being met. However, in this case, it will be a continuously-running cycle. It will not time out after any designated amount of time.

CAUTION: This option is meant for factory use only. Do not operate the dryer with this cycle active without factory authorization.

Error Code Historical Log:

The last fifteen occurring error codes will be stored in the control with a time and date stamp. The purpose of this option is only to observe the history of these code occurrences (no changes can be made). The time is based off the Real Time Clock, but potentially shifted by the user’s manual programming changes (Shift Hours option) and/or network time override. As additional error codes occur, the oldest of the fifteen logged codes is cleared from memory.

Prices Option:

This option allows the user to set values for coin acceptor inputs, vend price & time and extend dry price & time. It also allows the user to return the values to factory defaults. After changing prices using the “Up” or “Down” buttons, the “Enter” button must be pressed again for the control to store the changes that have been made. Note that, in general, time values are set in 1 minute increments. This can be changed to 30 second increments, by changing the “Display Time” to “MIN+SEC” (refer to the “Settings” section”).

1. “RIGHT COIN” and “LEFT COIN” are the two possible inputs from coin acceptors.
2. “PRICE SET VEND” is the actual Base Vend Price (or Vend Price A) that is shown on the control display. The value can be increased or reduced even down to “0”. In this case, the displays will prompt “FREE” and the cycle will start as soon as the “Start” button is pressed (without any vend price being met).
3. “TIME SET VEND” is the cycle time that the customer has available once they’ve met the Base Vend Price.
4. “FREE SET TIME” is the cycle time that the customer has available if the Base Vend Price is set to “FREE”.
5. “EXTEND DRY” sets the price and time for additional drying time that becomes available after the customer has already met the Base Vend Price.

To reset either the coin acceptor inputs or the vend price to factory default, press “Enter” when the “DEFAULT” prompt is shown. Press “Enter” again when the “RESET” prompt is shown to confirm the action.

Example- A store owner has programmed the control for the following values:

Base Vend Price	\$1.00
Base Vend Time	30 minutes
Extend Dry Price	\$.25
Extend Dry Time	8 minutes

In this case, the customer adds 4 quarters to satisfy the \$1.00 Vend Price. The display shows 30 minutes of drying time. At this point, if an additional quarter is added, the customer display shows an additional 8 minutes of drying time (38 minutes total) as per the Extend Dry Price & Time.

The customer starts the drying cycle and at 25 minutes into the cycle (13 minutes displayed), they add an additional quarter. The controller adds 8 minutes to the displayed time again (21 minutes total) as per the Extend Dry Price & Time.

“AFTER CYCLE” allows the user to choose whether a customer is allowed to add “EXTEND DRY” time for up to 30 seconds after the dryer door is opened after a completed cycle.

The figure below shows the sub menu options for Prices:

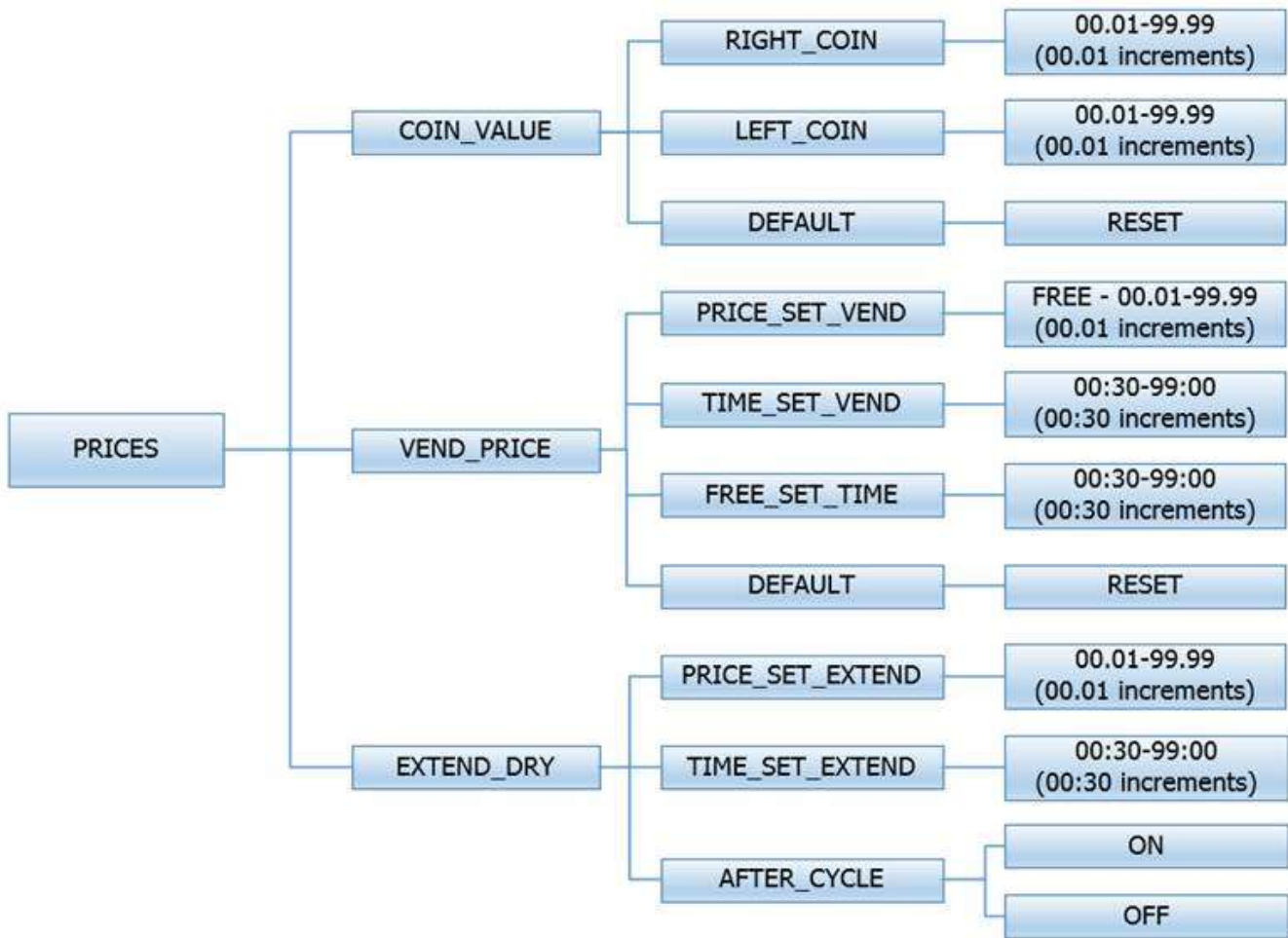

Cycles Option:

This option allows the user to set temperature and cooldown information for the drying cycle. It also allows the user to return the values to factory defaults.

1. "TEMP SETTINGS" allows the user to make adjustments, within a designated range, to the cycling temperature for each of the "Low", "Medium" and "High" customer choices.
2. In addition, on the "Low" setting, the user can reduce the cycling temperature below 110 degrees F. In this case, when the customer chooses the "Low" setting, the dryer will not turn on the gas valve. When checked, the displayed temperature will read "NO HEAT". Press and hold the "start" button and the active temperature button while the dryer is running to display the current dryer temperature.
3. "COOLDOWN" allows the user to change the designated time at the end of a cycle where the gas valve relay is turned off. On "High" and "Medium" temperature settings, the designated time cannot be reduced to less than 2 minutes. On the "High" temperature setting for -39/-49 machines, the designated time cannot be reduced to less than 4 minutes.
4. "DEFAULT TEMP" allows the user to choose which general temperature setting, "High", "Medium" or "Low", the control will default to at the beginning of each cycle if the customer does not make a choice.
5. "ANTI WRINKLE" is a feature that periodically rotates the dryers after a cycle is complete. If the door was closed at the end of the cycle, and is left closed for 5 minutes, the enunciator will sound and the display begins scrolling "ANTI WRINKLE". 5 seconds later, the dryer motor will turn on for 60 seconds and then turn off. The gas valves will not be turned on. The "ANTI WRINKLE" message will continue throughout the time that the motor is turned on. The user can choose to enable or disable this feature.
6. "MAX CYCLE TIME" allows the user to set the maximum time that can be purchased for a cycle. This includes the total time purchased before the cycle is started, while the cycle is running, and after the cycle ends.

To reset all values in the Cycles option to factory default, press "Enter" when the "DEFAULT" prompt is shown. Press "Enter" again when the "RESET" prompt is shown to confirm the action.

The figure below shows the sub menu options for Cycles:

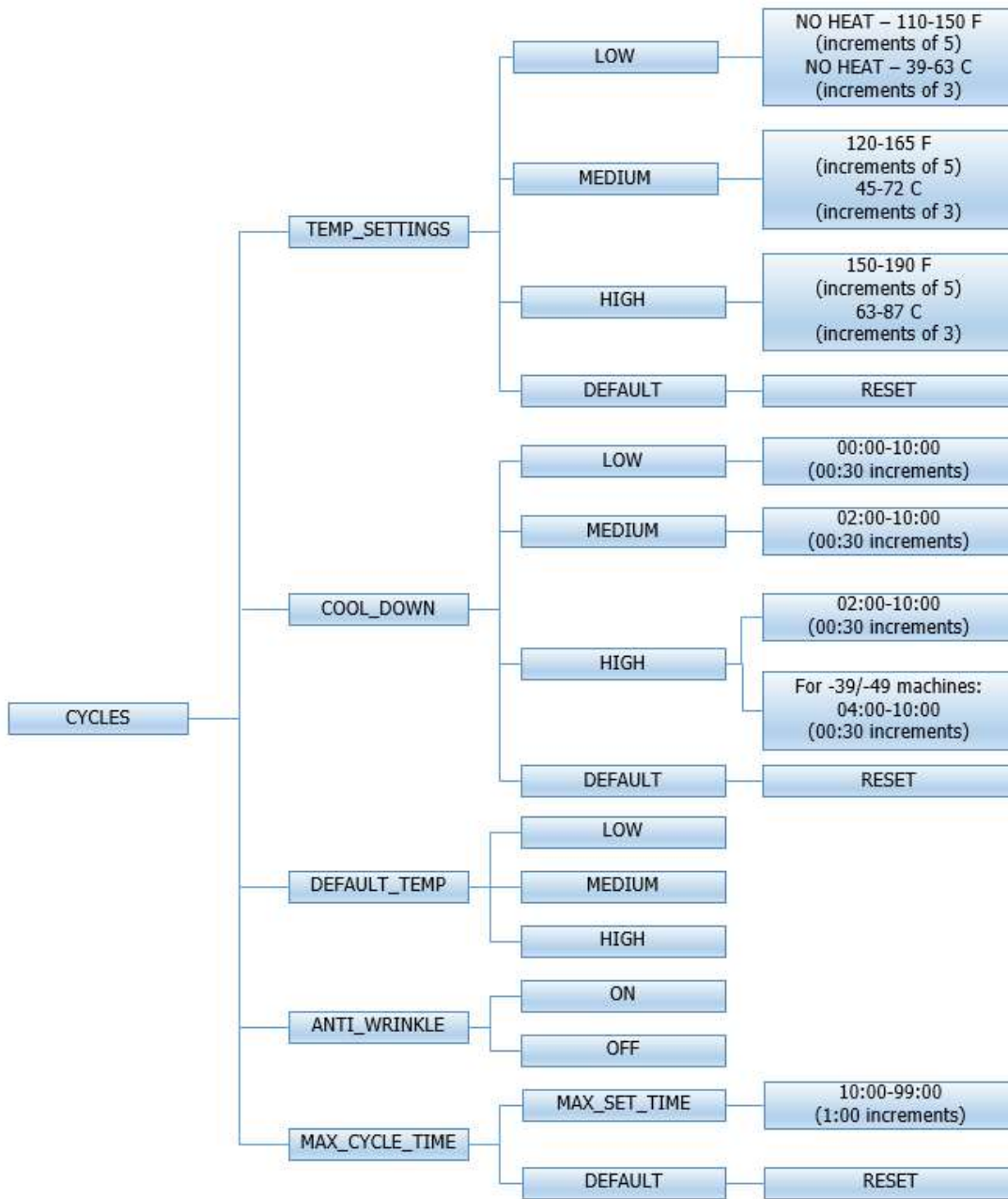

Temperature Pricing Option:

This option allows the user to require additional vend amounts be added based on the drying temperature chosen by the customer. This pricing adder is effective only for the Base Vend Price (it does not affect the Extend Dry Price). It allows a pricing adder separate for "Medium" and "Hot" temperature settings.

Example- A store owner has programmed the control for the following:

Vend Price	\$1.00
Vend Time	30 minutes
Extend Dry Price	\$.25
Extend Dry Time	8 minutes
Medium Adder	\$.25
Hot Adder	\$.50

In this case, the Vend Price is displayed as:

\$1.00 if Low Temperature is chosen

\$1.25 if Medium Temperature is chosen

\$1.50 if Hot Temperature is chosen

When Temperature Pricing Adders are in place (user has chosen a higher value then \$0.00), if the customer attempts to change their temperature selection from a lower temperature to a higher one during a drying cycle, there will be no change in the temperature selection. The higher temperature buttons are disabled until the drying cycle is complete and a new Vend Price is required.

The figure below shows the sub menu options for Temperature Pricing:



Settings Options:

The Settings options allow for the user to make various programming changes to change how the control operation affects the customer. See below for detailed information on each next level option.

1. "Decimal Point": If the user programs the Decimal Point to "OFF", control display will not show a decimal point on any vend price values. The factory default is "ON".
2. "Display Time": If the user programs this value to "MIN", then minutes only will be shown for the cycle time. If it is programmed to "MIN+SEC", then minutes and seconds will be shown. This also allows other programming changes, involving time, to be made in either minute increments or minutes & seconds increments, as desired.
3. "Temp Scale": If the user programs this value to "F", then the temperatures will be displayed in Fahrenheit units. If it is programmed to "C", then the temperature will be in Celsius units.
4. "Sounds": If the user programs the Sounds to "OFF", the control will not sound the enunciator at the end of a dry cycle. The factory default is "ON".
5. "Password": If the user programs the password to any value other than 0000, the control will prompt the user to enter a password (the programmed value) before manual programming can be accessed. The factory default is "0000" (no password).
 - a. Note that if the user forgets the Password, it can be reset to factory default (no password), by performing a hard reset on the control. Please refer to the appropriate section of this manual to understand how to perform a hard reset.
 - b. The individual digits of the Password can be set by using the "Up" or "Down" buttons to change the number that is flashing. Once the desired number is chosen for a single digit, press the "Enter" button to move to the next one. Once all four desired digits are chosen, the "Enter" button must be held down for 3 seconds to confirm that the complete password should be set.
6. "Language": The control uses English for the default language of the customer prompts. Alternatively, the user can choose Spanish, French, Malay, Italian or Greek for the customer display prompts. However, all other prompts, such as Manual Programming, USB Programming and any Error Codes will still display in English.
7. "Shift Hours": This feature allows the user to shift the time used by the control from the time kept internally by the control. The control uses a Real Time Clock (RTC) to internally track the time and date. The RTC continues operation even if the control loses external power. The RTC is set for Central Standard Time and no daylight savings. Because the machine may be located in another time zone, the user can choose to create an alternate time & date that tracks in parallel to the RTC. When this alternate time is chosen, or shifted from the RTC, the alternate time will be used to, for example, track error code occurrences and set time-of-day pricing changes.
 - a. The hours in "SHIFT HOURS" can be set by using the "Up" or "Down" buttons to change the number that is flashing. Once the desired hour shift is chosen, press the "Enter" button to move to the minutes. Once the hours and minute shift are both chosen, the "Enter" button must be held down for 3 seconds to confirm that the complete shifted time is set.
8. "Time": The control uses a Real Time Clock (RTC) to internally track the time and date. The RTC continues operation even if the control loses external power. The RTC is set for Central Standard Time and no daylight savings. However, if a problem occurs and the RTC time is not accurate, it can be reset to the current time using this option.
 - a. The hours in "TIME" can be set by using the "Up" or "Down" buttons to change the number that is flashing. Once the desired hour is chosen, press the "Enter" button to move to the minutes. Once the hours and minute are both chosen, the "Enter" button must be held down for 3 seconds to confirm that RTC is meant to be reset to the complete entry.
9. "Date": Similar to "Time", if a problem occurs and the RTC date is not accurate, it can be reset to the current date using this option.
 - a. The day of the month in "DATE" can be set by using the "Up" or "Down" buttons to change the number that is flashing. Once the desired day of the month is chosen, press the "Enter" button to move to the month of the year. Once the desired month of the year is chosen, press the "Enter" button to move to the year. Once the day, month and year are all chosen, the "Enter" button must be held down for 3 seconds to confirm that RTC is meant to be reset to the complete entry.
10. "Out of Service" – The control can be put into an Out-of-Service mode via manual programming. When the mode is "ON", the control will scroll "OUT OF SERVICE" on the display. The machine will not react to any vend input and will not operate when in this mode. The factory default is "OFF".

11. "Alt Cool Down": This setting is for factory use only.

To reset all values in the Settings options to factory default, press "Enter" when the "DEFAULT" prompt is shown. Press "Enter" again when the "RESET" prompt is shown to confirm the action.

The figure below shows the sub menu options for Settings:

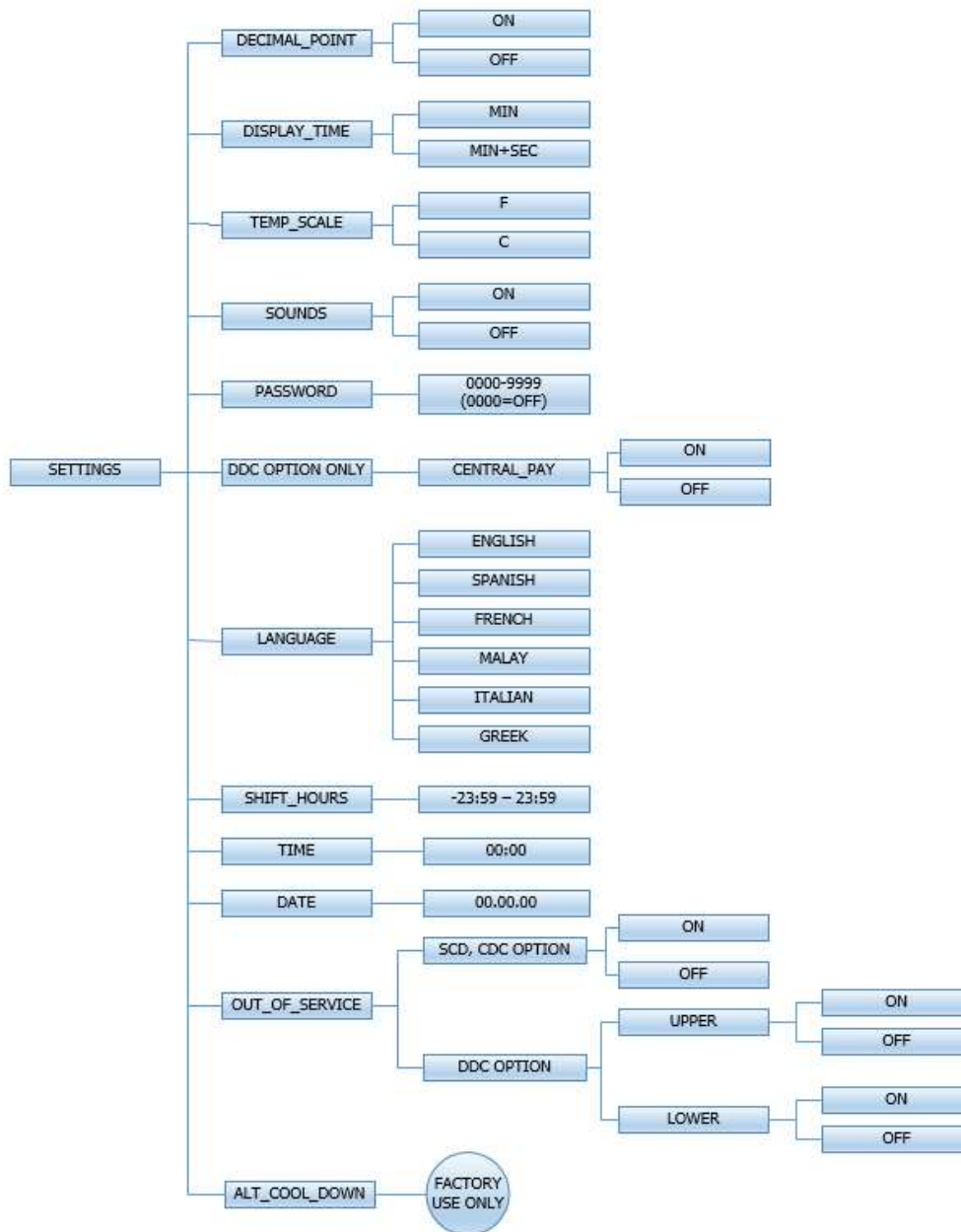

Usage Menu:

The Usage menu allows for the user to track data about machine usage. See below for detailed information on each sub menu option.

1. "Coin Audit": The coin audit field shows the accumulation of coin pulses that were sent to the control over each of the left and right coin inputs. Note that this is a count of coin pulses, not an accumulated report of vend value.
 - a. The user can also return the coin audit amounts to the factory default setting (zero). To reset all coin audit values, press "Enter" when the "DEFAULT" prompt is shown. Press "Enter" again when the "RESET" prompt is shown to confirm the action.
2. "Motor Hours": The motor hours field shows the accumulated hours of operation for the dryer motor. In many cases, it will match the cycle hours of the machine. However, separate fields are provided in the event that a motor is replaced on a machine. The user can set the motor hours to a designated number. For example, if it is necessary to replace the control on a machine, the new control could be programmed to show the motor hours that were recorded by the previously installed control. The individual digits of the hours count can be set by using the "Up" or "Down" buttons to change the number that is flashing. Once the desired digit of the hours is chosen, press the "Enter" button to move to the next digit. Once the complete hours are chosen, the "Enter" button must be held down for 3 seconds to confirm the action.
 - a. The user can also return the motor hours to the factory default setting (zero). To reset the motor hours, press "Enter" when the "DEFAULT" prompt is shown. Press "Enter" again when the "RESET" prompt is shown to confirm the action.
3. "Cycle Hours": The cycle hours field shows the accumulated hours of operation for the dryer. In many cases, it will match the motor hours of the machine. However, separate fields are provided in the event that a motor is replaced on a machine. See the Motor Hours description for more information.

The figure below shows the sub menu options for Usage:

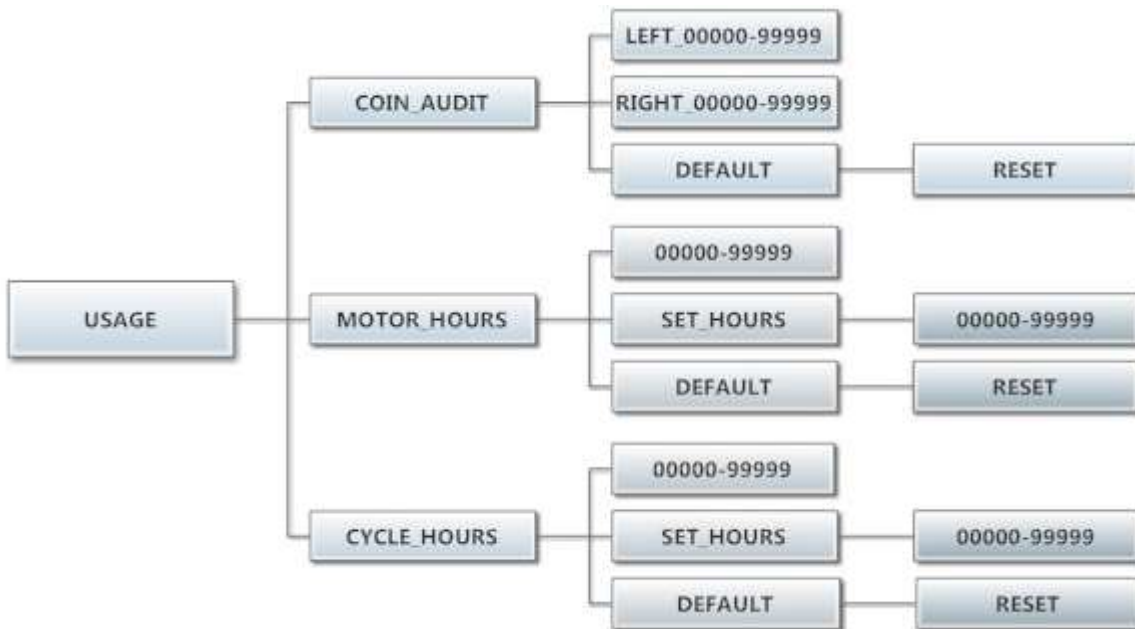

Control Menu:

The Control menu allows for the user to observe important technical information for the control. No changes can be made at this menu. See below for detailed information on each sub menu.

1. "Serial Number": This is the control serial number.
2. "MAC Address": The MAC Address is a unique identifier designated to the control by the manufacturer. It allows the control to be recognized by network routers.
3. "IP Address": The IP Address is the identifier given to the control by a network system.
4. "M Firmware": The M Firmware is the Main Firmware currently loaded onto the control.
5. "C Firmware": The C Firmware is the Communications Firmware currently loaded onto the control.

The figure below shows the sub menu options for Control:



REVERSING OPTIONS

The dryer can be set to reverse at different intervals dependent on owner's preference. The style of operation is determined by the location of the **BROWN** jumper wire located in the rear control box, on the frequency drive. (see image for jumper location)



STYLE	Dryer Operation	FWD (sec)	REV (sec)	Jumper Locations	
				Pos (1)	Pos (2)
1	NON-REV.	YES	NO	DCM	MCM
2	REV.	30	30	DCM	MI2
3	REV.	60	60	DCM	MI4
4	REV.	90	90	DCM	MI5
5	REV.	120	120	DCM	MI6

SERVICING AND TROUBLESHOOTING

CAUTION: Label all wires prior to disconnection when servicing controls. Wiring errors can cause improper and dangerous operation. Verify proper operation after servicing.

IMPORTANT: Clothes should be removed from the dryer as soon as possible after the cycle is completed and then folded or hung to prevent excessive wrinkling.

If any of the following symptoms occur on this dryer, check the suggested remedies listed below. If all probable causes have been eliminated and the symptom still exists, contact your local Dexter agent for further troubleshooting assistance. See contact information in Preventative Maintenance section. Parts & Service Manuals from Dexter are also available for further troubleshooting assistance.

Symptom	Probable Cause	Suggested Remedy
Tumbler Does not turn	Control	Check that Control Display shows time available for drying. If not, deposit money as needed.
	Loading Door	Check that Loading Door is completely closed
	Lint Compartment Door	Check that Lint Compartment Door is completely closed.
	Drive Belts	Check drive belts for excessive wear. Replace as needed.
	Variable Frequency Drive Fault	Contact Dexter agent for assistance
Tumbler Turns, but no burner flame is present	Gas shut-off valve	Make sure gas shut-off valve is in the open position
	Ignition Module	Follow the procedure for checking the ignition cycle listed in Dryer Ignition section of this manual.
Slow Drying	Control	Check that proper Temperature setting is chosen.
	Lint Screen	Clean Lint Screen
	Air flow Restrictions/ Make-up Air	Follow installation guidelines for static back pressure and make-up air
	Exhaust	Check exhaust for obstructions, follow installation guidelines
"Temp Sensor Short" or "Temp Sensor Open" Error Code displayed on control	Temperature Sensor	Press programming button to clear Error Code. If Error code persists, contact Dexter agent for assistance
"PCB Error" or "Comm Error" code displayed on control	Control Error	Cycle power to dryer to clear Error Code. If Error Code persists, contact Dexter Agent for Assistance

PREVENTIVE MAINTENANCE INSTRUCTIONS

Note: A key with the markings "6324" is provided for service access to controller and another key with markings "6101" is provided for service access to the lint screens, both by a qualified person. These keys should be stored in a secure place away from the dryer. A different key is required to open the coin box, if provided.

PREVENTIVE MAINTENANCE INSTRUCTIONS continued

DAILY (WARNING: Do not operate the dryer without the lint screen in place.)

Use service key to gain access to the lint screen compartment.

1. Clean the lint screen. Use a soft brush if necessary.
2. Check the lint screen for tears. Replace if necessary.
3. Clean lint from the lint screen compartment.

Relock lint screen compartment to prevent unauthorized access.

MONTHLY

1. Remove lint accumulation from the end bells of the motor and the front control area.
2. Remove lint and dirt accumulation from the top of the dryer and all areas above, below, and around the burners and burner housing. Failure to keep this portion of the dryer clean can lead to a build-up of lint creating a fire hazard.
3. Place a few drops of general purpose lubricating oil on the clothes door hinge.

QUARTERLY

1. Check the belts for looseness, wear, or fraying.
2. Inspect the gasket of the door glass for excessive wear.
3. Check tightness of all fasteners holding parts to support channel.
4. Check tightness of all set screws.
5. Inspect the impeller for tightness of the blades to hub.
6. Check the tightness of the tumbler shaft retaining bolt.
7. Remove the air flow switch assembly and check the tumbler thru-bolts for tightness.
8. Remove lint accumulation from the primary air ports in the burners.

SEMI-ANNUALLY

1. Remove and clean the main burners.
2. Remove all orifices and examine for dirt and hole obstruction.
3. Remove all lint accumulation. Remove the front panel and the lint screen housing and remove lint accumulation.

ANNUALLY

1. Check and remove any lint accumulation from the exhaust system.

SERVICE PARTS

PART NUMBER

DRIVE BELT, TUMBLER	9040-076-003
LINT SCREEN FILTER	9555-057-008
SERVICE MANUAL	8533-086-001

For service and parts information, contact your local Dexter agent. If a Dexter agent is not available, contact **Dexter Laundry, Inc.** directly as listed below:

Mailing Address: 2211 West Grimes Avenue Phone: 1-800-524-2954
Fairfield, IA 52556 USA

Website: www.dexter.com



**EC DECLARATION OF CONFORMITY
WITH COUNCIL DIRECTIVE 2006/42/EC**

Directive:	Machinery Directive on machinery safety, 2006/42/EC	
Conforming Machinery:	Commercial Drying System Model Numbers: DC30X2N, DC50X2N, DC0030N, DC0050N, DC0080N, DC0120N, DCS030N, DCS050N Serial Numbers:	
Manufacturer:	Dexter Laundry, Inc. 2211 West Grimes Avenue Fairfield, IA 52556 USA	
Harmonised Standards Referenced or Applied:	EN ISO 12100:2010	Safety of machinery. General principles for design. Risk assessment and risk reduction.
	EN 349:1993+A1:2008	Safety of machinery. Minimum gaps to avoid crushing of parts of the human body.
	EN 614-1:2006+A1:2009	Safety of machinery. Ergonomic design principles. Terminology and general principles.
	EN 953:1997+A1:2009	Safety of machinery. Guards. General requirements for the design and construction of fixed and movable guards.
	EN 1037:1995+A1:2008	Safety of machinery. Prevention of unexpected start-up.
	EN ISO 13857:2008	Safety of machinery. Safety distances to prevent hazard zones being reached by upper and lower limbs.
	EN ISO 14119:2013	Safety of Machinery. Interlocking devices associated with guards. Principles for design and selection.
	EN ISO 10472-1:2008	Safety requirements for industrial laundry machinery. Common requirements.
	EN ISO 10472-4:2008	Safety requirements for industrial laundry machinery. Air Dryers.
	EN 60335-1:2012/AC:2014	Safety of machinery. Electrical equipment of machines. General requirements.
Specifications with which Conformity is Declared:	Essential Health and Safety Requirements of Annex1 of the Machinery Directive	
We hereby certify that the machinery described above conforms with the essential health and safety requirements of Council Directive 2006/42/EC on the approximation of the laws of the Member States relating to the safety of machinery.		
Date:		
Signed:		
Signatory:	Mark Cox Director of Engineering	





EC DECLARATION OF CONFORMITY WITH COUNCIL DIRECTIVE 2004/108/EC		
Directive:	Electromagnetic Compatibility Directive 2004/108/EC	
Conforming Machinery:	Commercial Drying System Model Numbers: DC30X2N, DC50X2N, DC0030N, DC0050N, DC0080N, DC0120N, DCS030N, DCS050N	
Manufacturer:	Dexter Laundry, Inc. 2211 West Grimes Avenue Fairfield, IA 52556 USA	
Harmonised Standards Referenced or Applied:	EN 55014-1:2006/A2:2011 CISPR 14-1:2005/A2:2011	Electromagnetic compatibility. Requirements for household appliances, electric tools and similar apparatus. Emission.
	EN 55014-2:1997/A2:2008 CISPR 14-2:1997/A2:2008	Electromagnetic compatibility. Requirements for household appliances, electric tools and similar apparatus. Immunity. Product family standard.
	EN 61000-3-2:2014	Electromagnetic compatibility (EMC). Limits. Limits for harmonic current emissions (equipment input current $\leq 16A$ per phase).
	EN 61000-3-3:2013	Electromagnetic compatibility (EMC). Limits. Limitation of voltage changes, voltage fluctuations and flicker in public low-voltage supply systems, for equipment with rated current $\leq 16A$ per phase and not subject to conditional connection.
Specifications with which Conformity is Declared:	Electromagnetic Compatibility Directive	
We hereby certify that the machinery described above conforms with the essential health and safety requirements of Council Directive 2004/108/EC on the approximation of the laws of the Member States relating to the safety of machinery.		
Date:		
Signed:		
Signatory:	Mark Cox Director of Engineering	

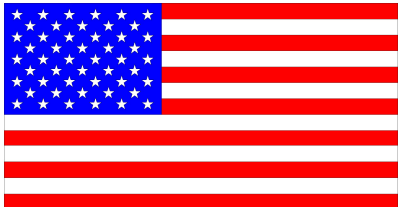

Declaration of Noise Emission

The Dexter Laundry Commercial Drying System Models Sound Pressure Levels per EN ISO 11202 as measured on similarly constructed models are as follows:

Model DCBD30KC-64FN	Operating	Idle
L_{pAm} (Operator Position)	61 dB (A)	54 dB (A)
L_{pAm} (Bystander Position)	68 dB (A)	58 dB (A)
Peak C-weight instantaneous SPL in the Operator's position	73 dB (C)	---
Sound power emitted where the equivalent continuous A-weighted SPL exceeds 80 dB (A).	N/A	---
The average difference between the extraneous noise level and the sound intensity level at each measuring point is:	L_{pAm} Δ = 9 dB (A)	
Ambient Correction Factor K3A calculated according to EN ISO 11204 Appendix A.	4 dB(A)	
Measurements were made at a height of 1.5 m and 1 m from the Operator Position and all four sides of the equipment.		
<p>The figures quoted are emission levels and are not necessarily safe working levels. While there is a correlation between the emission and exposure levels this cannot be used reliably to determine whether or not further precautions are required.</p> <p>Factors that influence the actual level of exposure of the workforce include characteristics of the work room, the other sources of noise, etc. such as the number of machines and other adjacent processes. Also, the permissible level of exposure can vary from country to country.</p> <p>This information, however, will enable the user of the machine to make a better evaluation of the hazard and risk.</p>		
	Dexter Laundry, Inc. 2211 West Grimes Avenue Fairfield, IA 52556 USA	



EC DECLARATION OF CONFORMITY WITH COUNCIL DIRECTIVE 2009/142/EC		
Directive:	Appliances Burning Gaseous Fuels Directive 2009/142/EC	
Conforming Machinery:	Commercial Drying System Model Numbers: DC30X2N, DC50X2N, DC0030N, DC0050N, DC0080N, DC0120N, DCS030N, DCS050N	
Manufacturer:	Dexter Laundry, Inc. 2211 West Grimes Avenue Fairfield, IA 52556 USA	
Harmonised Standards Referenced or Applied:	EN 12752-1:1999	Gas-Fired type B tumble dryers of nominal heat input not exceeding 20kW - Part 1: Safety
Specifications with which Conformity is Declared:	Appliances Burning Gaseous Fuels Directive	
<p>We hereby certify that the machinery described above conforms with the essential health and safety requirements of Council Directive 2009/142/EC on the approximation of the laws of the Member States relating to the safety of machinery. The products listed have been designed and manufactured in accordance with the type as described in the EC Type Examination Certificate issued by Intertek Testing & Certification Ltd (Notified Body 0359).</p>		
Date:		
Signed:		
Signatory:	Mark Cox Director of Engineering	