

**INDUSTRIAL WASHER  
MODEL T-1200 ON-PREMISE  
V-SERIES CONTROL – 50Hz**

**Original Instructions  
For GB & IE**



**DEXTER<sup>®</sup>**  
**LAUNDRY**

**OPERATOR'S MANUAL  
INSTALLATION & OPERATION  
INSTRUCTIONS**

Please read this information and retain for reference.

The washer will operate correctly in ambient temperatures of +5°C to +40°C, in relative humidity up to 50% at +40°C and above 50% when below +40°C, and at altitudes up to 1000m above sea level, must be transported and stored from -25°C to +55°C and up to +70°C for short periods of time, and has been packaged to prevent damage from humidity, vibration, and shock. Take measures to avoid harmful effects of occasional condensation.

**WARNING** - THIS WASHER IS EQUIPPED WITH DEVICES AND FEATURES RELATING TO ITS SAFE OPERATION. TO AVOID INJURY OR ELECTRICAL SHOCK, DO NOT PERFORM ANY SERVICING UNLESS QUALIFIED TO DO SO.

IT IS THE RESPONSIBILITY OF THE OWNER TO CHECK THIS EQUIPMENT ON A FREQUENT BASIS TO ASSURE ITS SAFE OPERATION.

A machine should NOT be allowed to operate if any of the following occur:

- Excessively high water level.
- If machine is not connected to a properly earthed circuit.
- If the door does not remain securely locked during the entire cycle.
- Vibration or shaking from an inadequate mounting or foundation.

**WARNING - SAFETY PRECAUTIONS**

- Always shut off power and water supply before servicing.
- Do not overload the washer.
- Do not open door when cylinder is in motion or it contains water.
- Do not bypass any safety devices of this washer.
- Do not use volatile or flammable substances in or near this washer.
- Bleach is corrosive and use may cause component failure under certain circumstances.
- Keep all panels in place. They protect against shock and injury and add rigidity to the washer.

This appliance can be used by children aged from 8 years and above and persons with reduced physical, sensory or mental capabilities or lack of experience and knowledge if they have been given supervision or instruction concerning use of the appliance in a safe way and understand the hazards involved. Children shall not play with the appliance. Cleaning and user maintenance shall not be made by children without supervision. Children of less than 3 years should be kept away unless continuously supervised.

**PREVENTIVE MAINTENANCE REQUIREMENTS**

DAILY - Leave all panels in place while performing these steps.

- Check that the loading door remains securely locked and cannot be opened during an entire cycle.
- Check the water connections for leaks.
- Clean the top, front, and sides of the cabinet to remove residue.
- Clean the soap dispenser and lid and check that all dispenser mounting screws are in-place and tight.
- Check the drain valve for leaking and that it opens properly.
- Check the loading door for leaks. Clean the door seal of all foreign matter.
- Leave the loading door open to aerate the washer when not in use.

QUARTERLY - Apply proper lock out tag out procedures before performing these steps.

- Make sure the washer is inoperative by switching off the main power supply.
- Check the V-belts for wear and proper tension.
- Clean lint and other foreign matter from around motor and variable frequency drive.
- Check all water connections for leaks.
- Wipe and clean the inside of the washer and check that all electrical components are free of moisture and dust.
- Remove and clean water inlet hose filters. Replace if necessary.
- Check anchor bolts. Retighten if necessary





















**IMPORTANT:** Replace any and all panels that were removed to perform daily and/or quarterly maintenance.





## TABLE OF CONTENTS

|     |   |    |
|-----|---|----|
| 1   | INSTALLATION INSTRUCTIONS .....           | 4  |
| 1.1 | UNCRATING INSTRUCTIONS.....               | 4  |
| 1.2 | FOUNDATION REQUIREMENTS .....             | 4  |
| 1.3 | MOUNTING .....                            | 4  |
| 1.4 | PLUMBING .....                            | 8  |
| 1.5 | DRAIN .....                               | 8  |
| 1.6 | PROTECTIVE FILM.....                      | 8  |
| 1.7 | ELECTRICAL.....                           | 8  |
| 1.8 | INJECTION SOURCE CONNECTIONS.....         | 11 |
| 1.9 | OPERATION CHECK.....                      | 11 |
| 2   | OPERATING INSTRUCTIONS.....               | 13 |
| 2.1 | STARTING THE WASHER .....                 | 13 |
| 2.2 | END OF CYCLE .....                        | 13 |
| 2.3 | EMERGENCY STOP / SAFETY DOOR LOCK.....    | 14 |
| 2.4 | VARIABLE FREQUENCY DRIVE INDICATORS ..... | 14 |
| 3   | MACHINE PROGRAMMING INSTRUCTIONS .....    | 15 |
| 3.1 | EDITING AN EXISTING CYCLE.....            | 15 |
| 3.2 | DEFAULT WASHER CYCLE PROGRAMS.....        | 17 |
| 3.3 | RAPID ADVANCE MODE .....                  | 21 |
| 3.4 | WATER LEVEL ADJUSTMENT.....               | 22 |
| 4   | WASHER ERROR CODES.....                   | 23 |
| 5   | TROUBLESHOOTING .....                     | 25 |
| 6   | SERVICE AND PARTS .....                   | 29 |

| MODEL                | T-1200 36.3 kg (80 LB.) WASHER   |
|----------------------|--|
| WASHER NET WEIGHT    | 480.8 kg (1060 LBS)  |
| CAPACITY             | 36.3 kg/325L (80 LBS/11.5 CUBIC FT.)   |
| CYLINDER SIZE        | 76.2 cm DIA. X 71cm DEEP (30" DIA. X 28" DEEP)   |
| ELECTRICAL           | 230 VAC, 50 HZ, 1 PHASE, 8.4 A   |
| DRIVE SYSTEM         | SOFT START REVERSING INVERTER DRIVE, 3 HP MOTOR  |
| WASH SPEED           | 43 RPM   |
| INTERMEDIATE EXTRACT | 375 RPM (60 G'S)   |
| FINAL EXTRACT        | 485 RPM (100 G'S)  |
| MACHINE CONTROL      | PROGRAMMABLE COMPUTER UP TO 6 CYCLES   |
| WATER INLET          | 4 SOLENOID OPERATED VALVES, 207-827 kPa (30-120 PSI)<br>FLOW RATE: 2 DUAL VALVES 35L/MIN (9 GAL/MIN) EACH.<br>2 SINGLE VALVES 45L/MIN (12 GAL/MIN) EACH. |
| DRAIN VALVE          | 76 mm (3") DIAMETER  |

**Table 1: Washer Specifications**

|   |   |  |   |
|---|---|--|---|
|    |  | Caution! There are sharp edges on various sheet metal parts internal to the enclosure. Use safety consciousness when placing or moving your hands while working in the interior of this equipment. |   |
|    | Meaning: Do Not Enter This Equipment (or Space).                                  |   | Meaning: Do Not Step, Stand, or Sit on This Equipment.  |
|    | Meaning: Do Not Operate with Guards or Covers Removed.                            |   | Meaning: High Voltage. Disconnect power before servicing.   |
|    | Meaning: Disconnect Power Before Servicing Equipment.                             |   | Meaning: Disconnect Water Supply Before Servicing Equipment.  |
|    | Meaning: Lock Out and Tag Out before servicing.                                   |   | Meaning: Burn Hazard. Do Not Touch Door Glass or Soap Compartments. Allow these parts to cool before servicing. |
|    | Meaning: Do Not Wash Items Containing Explosive Material.                         |   | Meaning: Do Not Wash Items Containing Flammable Material.   |
|    | Meaning: Read Operators Manual.   |   | Meaning: Do Not Supply Inlet Water > 88°C to the Water Inlet Valve to Reduce the Risk of Damage.                |
|    | Meaning: Do Not Operate in Any Hazardous Classified (ATEX) Environment.           |   | Meaning: Do Not Operate if Door Glass is Damaged in Any Way.  |
|   | Meaning: Left Point for Forklift or Hand Pallet Truck or Jack.                    |    | Meaning: Right Point for Forklift or Hand Pallet Truck or Jack.   |
|  | Meaning: Do Not Allow Children to Play in or Around Equipment.                    |   | Meaning: Supervise Children to ensure They Do Not Operate Equipment.  |

| Misuse of Washer  |   |
|---|---|
|  | Do not use this Equipment for any purpose not described in this Manual.   |
|  | Do not operate this equipment without all guards and covers in place.   |
|  | Do not operate this washer from any power source not matching the operational requirements on the back of the washer.     |
|  | Do not place your body inside the washer cylinder or allow others to do so. Death or serious injury can result from this! |
| Other Examples May Be Applicable  |   |

# 1 INSTALLATION INSTRUCTIONS

All washers must be installed in accordance with all local, state and national building, electrical, plumbing and other codes in effect in the area.

## **WARNING:**

**THESE INSTALLATION AND SERVICING INSTRUCTIONS ARE FOR USE BY QUALIFIED PERSONNEL ONLY. TO AVOID INJURY AND ELECTRICAL SHOCK, DO NOT PERFORM ANY SERVICING OTHER THAN THAT CONTAINED IN THE OPERATING INSTRUCTIONS, UNLESS QUALIFIED.**

### 1.1 UNCRATING INSTRUCTIONS

1. Use a knife or similar instrument to remove plastic wrap from the washer packaging.
2. Remove the cardboard pieces from the washer packaging.
3. Use a Phillips-Head screwdriver to remove the lower service door from the washer.
4. Use an 11/32" wrench or socket and ratchet to loosen the bottom three screws on the back panel and a 5/32" wrench or socket and ratchet to remove the remaining screws and back panel from the washer.
5. Use a 3/4" wrench and socket and ratchet to remove the four lag screws that attach the washer frame to the two wooden runners.
6. Use a forklift or pallet jack, at the front or back of the washer to remove the washer from the runners and to the mounting base or pedestal.

### 1.2 FOUNDATION REQUIREMENTS

This machine is designed for use on or over bare concrete floor - not to be used above combustible flooring, such as carpet or wood. The washer must be securely bolted **and grouted** to a substantial concrete floor, or mounted **and grouted** upon a suitable base that is securely bolted **and grouted** to a substantial concrete floor.

CARE MUST BE TAKEN WITH ALL FOUNDATION WORK TO ENSURE A STABLE UNIT INSTALLATION, ELIMINATING POSSIBILITIES OF EXCESSIVE VIBRATION.

All installations must be made on sound concrete floors, 203 mm (8 inches) or thicker. Anchor bolts or expansion anchors must be of a quality grade and a minimum of 19mm (3/4 inch) diameter. Six bolts are required to mount the washer to the steel base or concrete pad. Mounting hardware is not provided with the machine.

### 1.3 MOUNTING

A concrete pedestal or steel-mounting base that elevates the machine approximately 102mm (4 inches) above the floor level is recommended to provide easy access to the loading door. Allow a minimum 610 mm (24 inches) of clearance behind the rear of the machine to provide access for motor service. Refer to Figures Figure 1-1 and Figure 1-2 for machine bolt-down dimensions. Contact a Dexter laundry equipment distributor for recommended steel mounting bases.

If an elevated concrete pedestal is desired, it should be embedded into the existing floor. Anchor bolts should be 19 mm x 200 mm (3/4" x 8"), grade 8 or better, headed by a 100 mm (4 inch) square fish plate and should protrude 64 mm (2 1/2") above the finished surface of the pedestal.

EXPANSION ANCHORS ARE NOT RECOMMENDED FOR USE IN CONCRETE PEDESTALS BECAUSE THE ANCHORS ARE TOO CLOSE TO AN EDGE, CAUSING IT TO BREAK OUT.

Refer to Figures Figure 1-1 and Figure 1-3 for recommended concrete pedestal dimensions. Refer to Figure Figure 1-4 for overall machine mounting dimensions.

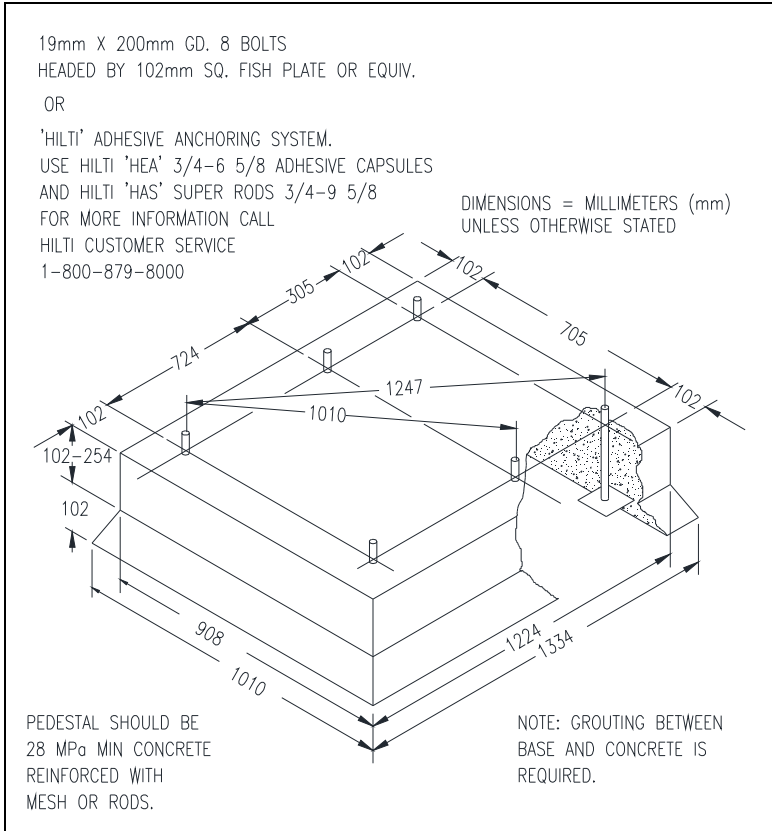

**Figure 1-1: Concrete Pedestal Mounting (metric)**

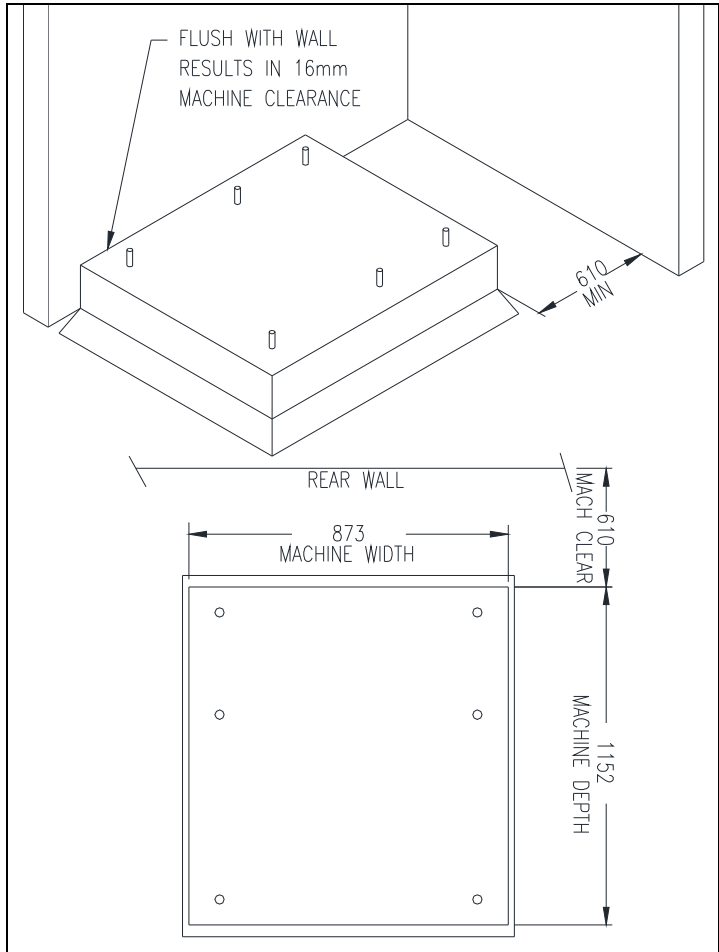

**Figure 1-2: Floor Outline (metric)**

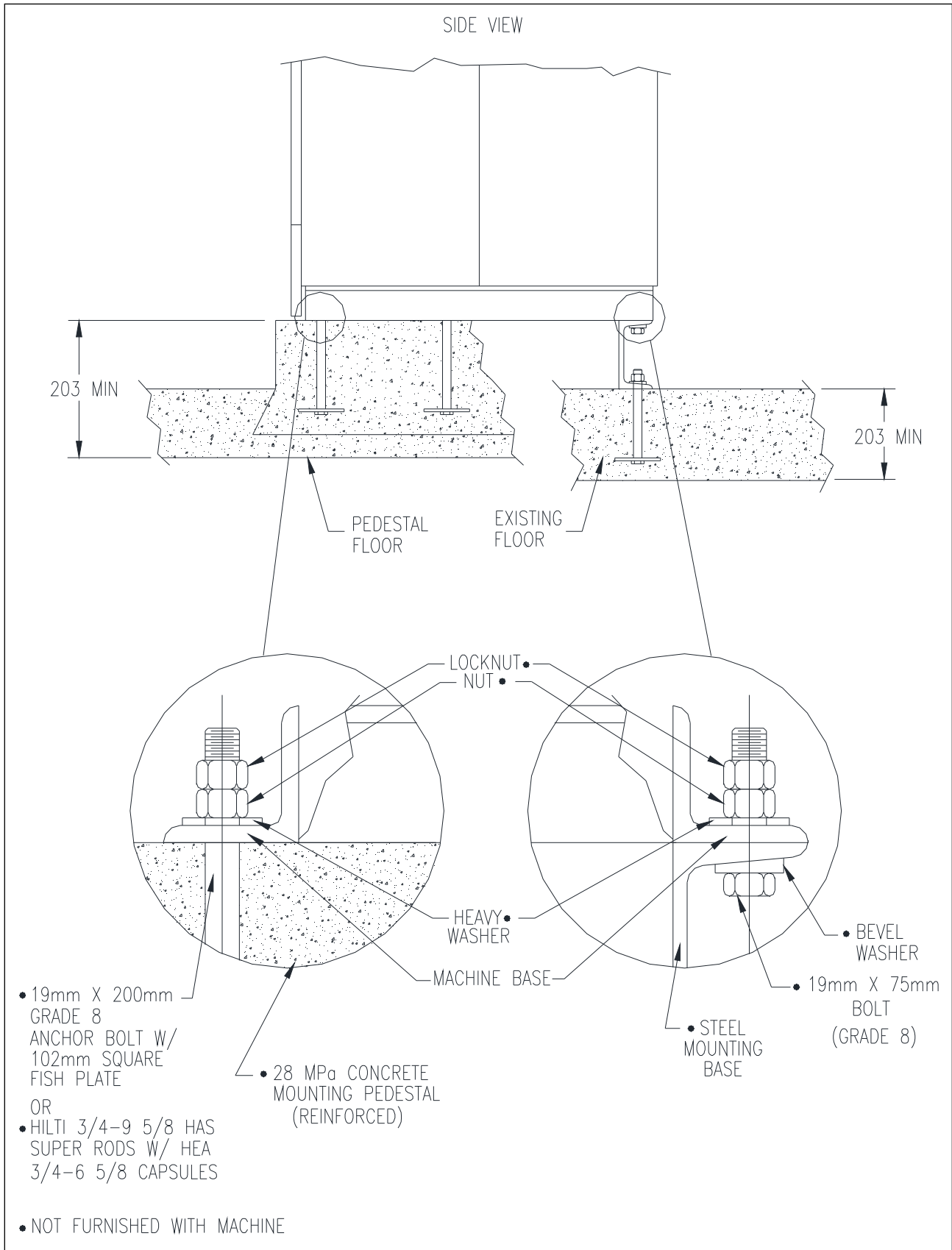

**Figure 1-3: Machine Mounting Detail (metric)**

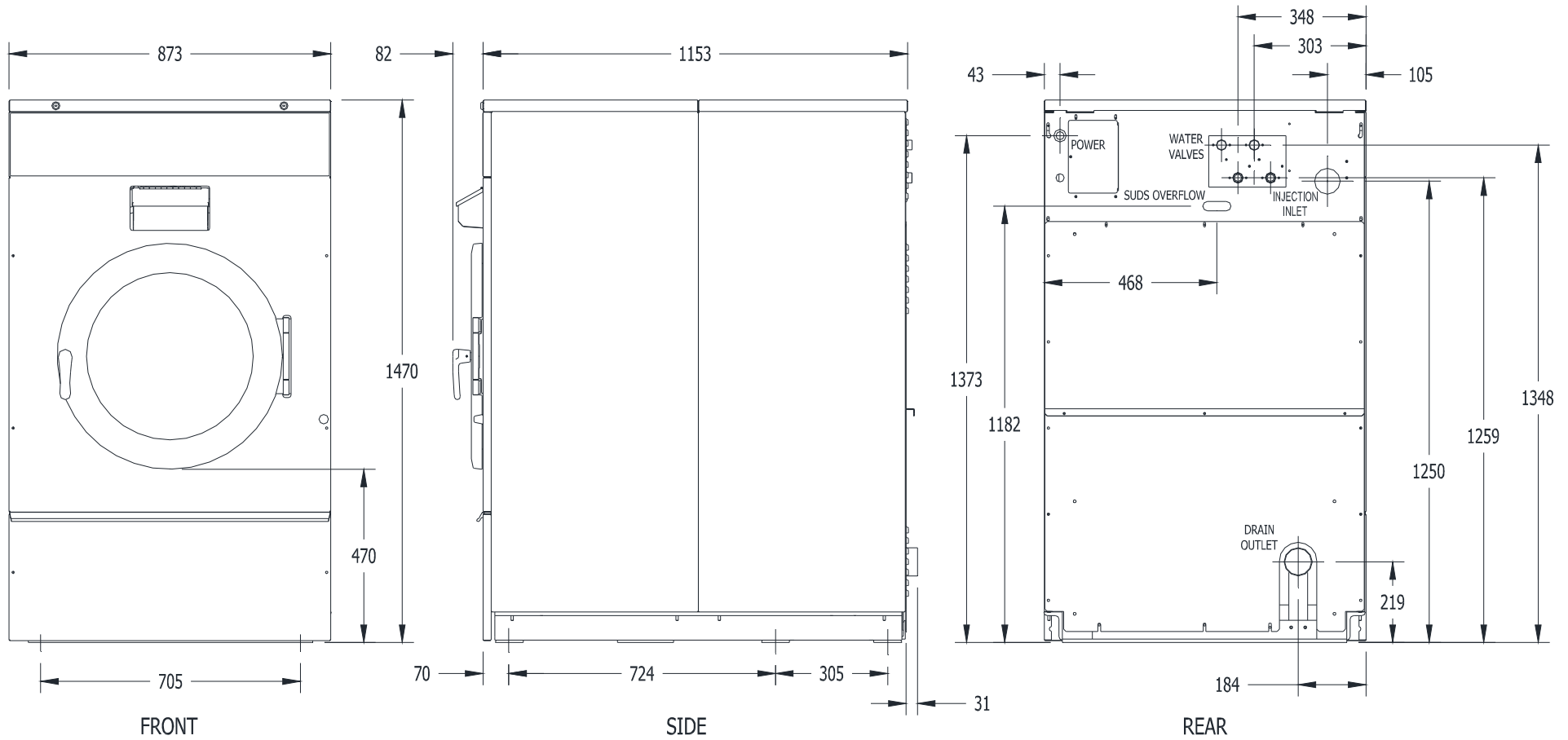

**Figure 1-4: T-1200 Industrial Washer Mounting Diagram**

(Dimensions are in mm)

## 1.4 PLUMBING

Four 1.22 m (48 inch) water supply hoses are provided with each machine. Use these new hose sets and do not reuse old hose sets. One end of the hoses is 3/4-11 1/2 NHT for the water valve connections while the other end of the hoses is 3/4-14 BSP for the water supply connections.

Separate hot and cold water lines must be supplied to the machine, maintaining 207 kPa to 827 kPa (30 psi to 120 psi) water flow pressure. A 60°C (140°F) hot water supply is recommended for best washing results. Do not exceed 88°C (190°F) water temperature.

## 1.5 DRAIN

The drain outlet tube at the rear of the machine is 76mm (3 inches) in diameter. Any drain hose used must be lower than the drain valve to assure proper draining.

## 1.6 PROTECTIVE FILM

The machine may have protective adhesive film on the front control panel label area and on the front, top, and side stainless steel panels. The film may be peeled off before putting the machine into service.

## 1.7 ELECTRICAL

The Dexter T-1200 single-phase 230VAC 50 Hz washing machines are intended to be permanently installed appliances. No power cord is provided. The machine should be connected to an individual branch circuit not shared by lighting or other equipment. Supplementary circuit protection is not allowed. A means for disconnection with a contact separation distance of at least 3mm must be provided. The connection should be sheathed in liquid tight flexible conduit, or equivalent, with conductors of the proper size and insulation. The sheath of the supply cord must be at least equivalent to that of a cord complying with IEC 227 or IEC 245. A qualified technician should make such connections in accordance with the wiring diagram with a minimum 3.5 mm<sup>2</sup> wire.

Individual circuit breakers for each unit are required. Do not use earth-fault circuit breakers or earth-fault circuit interrupter outlets.

**WARNING:**  
**SHUT OFF POWER AND WATER BEFORE OPENING ANY SERVICE PANELS.**

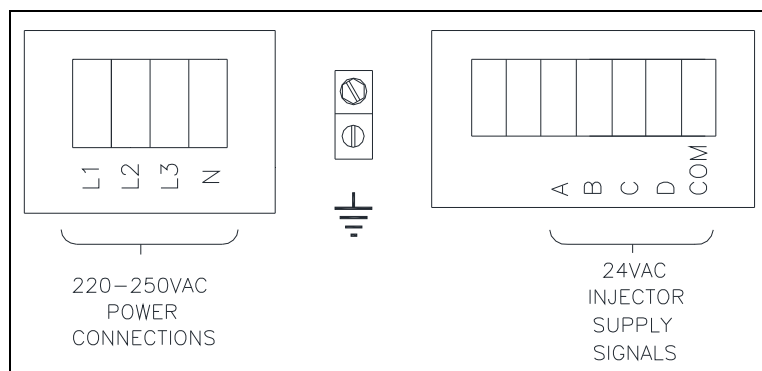

**Figure 1-5: Electrical Connections and Chemical Supply Signals**



### *1.7.1 INSTALLING THE ELECTRICAL CONNECTION*

1.7.1.1 Disconnect all power to the washer.

1.7.1.2 Remove the top panel of the washer and locate the power terminal block near the back of the control compartment. Connections are as shown in **Error! Reference source not found.**

1.7.1.3 Connect L1, N, and Earth as marked.

NOTE: It is important that the earthing screw next to the power terminal block TB-1 be connected to a good external earth.

### *1.7.2 FUSING REQUIREMENTS*

Single-phase models: 20 AMP TIME-DELAY (DUAL ELEMENT) FUSE (or equivalent circuit breaker)

The installation must meet the electrical requirements of the country of installation. The installer must provide a disconnect switch, which will interrupt all lines. It may be a local or national requirement to provide an electrical interruption switch visible and accessible from the room in which the washer is installed.

For destination countries where CE requirements must be met, individual 230V supply disconnecting devices for each dryer are required and must be one of the following types:

- a. switch-disconnector with fuses per IEC 60947-3 utilization category AC-23B;
- b. disconnector with fuses per IEC 60947-3 having an auxiliary contact that in all cases causes switching devices to break the load circuit before the opening of the main contacts of the disconnector;
- c. a circuit-breaker suitable for isolation per IEC 60947-2;
- d. any other switching device in accordance with an IEC product standard for that device and which meets the isolation requirements of IEC 60947-1 as well as a utilization category defined in the product standard as appropriate for on-load switching of motors or other inductive loads;

The supply disconnecting devices must

- a. provide a means allowing the supply disconnecting devices to be locked in the OFF position;
- b. be mounted 0.6 m to 1.9 m above the floor;
- c. be rated for branch circuit operation;
- e. be approved for use in the country where installed;

### *1.7.3 CONTROLS TRANSFORMER*

The controls transformer is located inside the control trough and steps a range of 220 to 250 volts down to 24 SELV. There are two terminals on the controls transformer for the primary (incoming) power. Use the terminal marked "220V" for power supplies between 195 and 225 volts. Use the terminal marked "250V" for power supplies between 226 and 255 volts.

## CONTROL TRANSFORMER CONNECTIONS

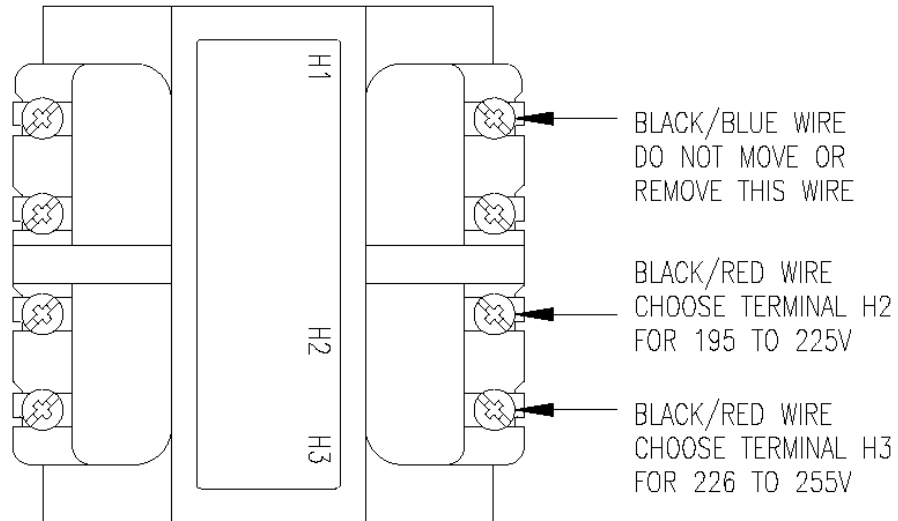
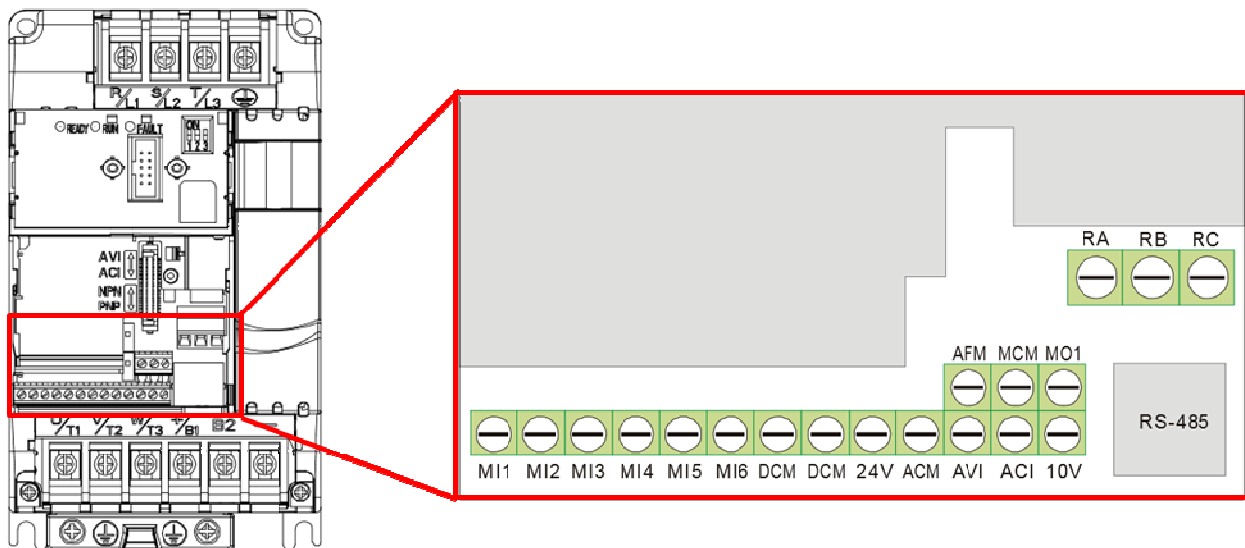

**Figure 1-6: Control Transformer Connections**

### 1.7.4 MAXIMUM SPIN SPEED ADJUSTMENT

If desired, the washer can be adjusted to limit the maximum extract spin speed for all wash cycles.

To make this adjustment, a jumper wire must either be installed or removed on the Variable Frequency Drive (VFD), depending on the washer model and desired speed. This Dexter jumper part number 8220-057-036 (qty 1) is factory supplied on terminal points "10V" and "RC". Remove this jumper to make new jumper connections if necessary. Refer to Figure 1-7 for the approximate location of the control terminations on the Variable Frequency Drive (VFD) and Table 2 for appropriate jumper connection points indicated with an "X" for the desired maximum spin speed setting. If no adjustment to default spin speed is desired, do not remove or add any wires on VFD.



**Figure 1-7: Control Terminations on Variable Frequency Drive**

| V Series Washer Model                    | Max Spin Speed | Jumper Terminal Locations on Variable Frequency Drive (VFD) |     |     |     |     |     |            |             |     |     |     |     |     |     |  |  |   |
|--|----------------|---|-----|-----|-----|-----|-----|------------|-------------|-----|-----|-----|-----|-----|-----|--|--|---|
|  |                | MI1   | MI2 | MI3 | MI4 | MI5 | MI6 | DCM (Left) | DCM (Right) | 24V | ACM | AVI | ACI | 10V | M01 |  |  |   |
| T-300, T-400,<br>T-600, T-900,<br>T-1200 | 60 G           |   |     |     |     |     |     |            |             |     |     |     |     |     | X   |  |  | X |
|  | 80 G           |   |     |     | X   |     |     |            | X           |     |     |     |     |     |     |  |  |   |
|  | 100 G          | Default Setting (No Jumper Required)                        |     |     |     |     |     |            |             |     |     |     |     |     |     |  |  |   |
| T-350, T-450,<br>T-750                   | 60 G           |   |     |     |     |     |     |            |             |     |     |     |     |     | X   |  |  | X |
|  | 100 G          |   |     |     | X   |     |     |            | X           |     |     |     |     |     |     |  |  |   |
|  | 140 G          |   |     |     |     | X   |     |            | X           |     |     |     |     |     |     |  |  |   |
|  | 200 G          | Default Setting (No Jumper Required)                        |     |     |     |     |     |            |             |     |     |     |     |     |     |  |  |   |
| T-650, T-950, T-1450                     | 100 G          |   |     |     |     |     |     |            |             |     |     |     |     |     | X   |  |  | X |
|  | 140 G          | REMOVE Brown Jumper between MI5/M01                         |     |     |     |     |     |            |             |     |     |     |     |     |     |  |  |   |
|  | 200 G          | Default Setting (With Factory Installed Brown Jumper)       |     |     |     |     |     |            |             |     |     |     |     |     |     |  |  |   |

**Table 2: Spin Speed Adjustment Jumper Locations**

1.8 INJECTION SOURCE CONNECTIONS

The washer control may be programmed to send six 24V output signals for a chemical injection system of up to four chemical sources. The signals are not intended as a power source and must be limited to less than 100 milliamps of current. There is a separate terminal block for connection of the external injection signals. For the injection sources, program codes 0 through 6 and their respective terminal block connections are as shown in Table 3.

| Dexter Recommended Connections | Controller Programmed Signals | Injection Terminal Block Circuits |
|--------------------------------|-------------------------------|-----------------------------------|
| Detergent                      | 1                             | A                                 |
| Bleach                         | 2                             | B                                 |
| Starch                         | 3                             | C                                 |
| Sour/Softener                  | 4                             | D                                 |
|                                | 5                             | A and B                           |
|                                | 6                             | C and D                           |
|                                | 0                             | None                              |

**Table 3: Injection Signal and Circuit Identification**

Chemical Injection hoses are to be inserted into the injection inlet at the upper right rear of the washer. These hoses should be inserted into the round PVC pipe a minimum of 35.5 cm (14") and a maximum of 45.7 cm (18") to eliminate chemical buildup in the pipe and/or restrict water flow to the tub. Secure the hoses as required.

1.9 OPERATION CHECK

After all mounting, plumbing and electrical work is completed, select any desired wash cycle and run the machine through a complete wash cycle. Check for water leaks and verify proper operation.

During intermediate spin and final spin, the cylinder should turn in a

**counterclockwise** direction when viewed from the front of the machine. If spin is clockwise, the T1 and T2 motor wires connecting to terminal T1 and T2 on the variable frequency drive should be swapped. Remove power to the machine before opening service panels and swapping wires.

NOTE: The A-weighted emission sound pressure level does not exceed 70dB(A). The operator does not need hearing protection.

NOTE: The washer does not emit hazardous radiation.



**WARNING:** To avoid potential risks of spontaneous combustion of a load, remove the load quickly after the completion of the cycle or in case of failure of power supply.



**DANGER:** Do not wash loads which may create an explosive atmosphere in the washer.

## 2 OPERATING INSTRUCTIONS

Maximum Load Capacity: 36.3 kg (80 pounds) Dry Weight for the T-1200.

### 2.1 STARTING THE WASHER

*2.1.1 Turn on power to the washer.*

*2.1.2 Ensure washer is in "RUN" mode.*

Locate the "RUN/PROGRAM" key switch and key. The current mode is indicated by the alignment of the key slot. If washer is not in "RUN" mode, insert and turn the key to the "RUN" position.

*2.1.3 Load the laundry.*

Place laundry loosely into the cylinder and latch the door securely. Be sure laundry does not get caught between the door gasket and tub front when closing the door. Do not load the washer with more than 36.3 kg (80 pounds).

**NOTE:** To begin closing the door, the handle must be in the horizontal position. After moving the door to the closed position, the handle must be turned down to the vertical position in order to latch the door for machine operation.

*2.1.4 Select wash cycle.*

Select the appropriate cycle number (1 through 6) for the type of load being washed. See the default cycle descriptions in section 3.2. Use the "UP" and "DOWN" keys to change the two digit cycle number on the display to the desired cycle.

*2.1.5 Add washing chemicals.*

If not using a chemical injection system, add low sudsing powdered detergent into the "DETERGENT" compartment of the automatic dispenser on the front of the washer.

If liquid wash products are used in the "DETERGENT" compartment, they must be added at the beginning of the wash cycle.

If desired, add fabric softener to the "FABRIC SOFTENER" compartment. Use the amount of fabric softener as recommended by the manufacturer.

If the machine is set for pre-wash, washing products can be added to the dispenser or put in with the clothes when loading the washing machine.

If bleach is desired, DO NOT place into dispenser until bleach light blinks during the wash cycle.

*2.1.6 Press "START".*

The display will go blank for a moment and then display the cycle time in minutes. The door will lock and remain locked until the end of the cycle.

### 2.2 END OF CYCLE

When the cycle is complete, the time will display "0" and a 5-second tone will sound. The door can now be opened. Immediately remove contents of washer. Leave the door open when the machine is not in use.

### 2.3 EMERGENCY STOP / SAFETY DOOR LOCK

This machine is equipped with a Safety Door Lock that locks the door closed from when the cycle is started until the cycle is complete. The door lock prevents opening the door for up to 3 minutes if the power is interrupted during the cycle.

Pressing the Emergency Stop button removes power from the controller of the washer. The door can be opened after the Safety Door Lock releases. When the Emergency Stop button is pressed, the washer will begin stopping movement and water flow, and begin draining water from inside the washer. After 6 seconds of power loss to the controller, the motor drive will begin ramping down the motor movement. Though the machine may stop wash movement quickly, it may take up to 3 minutes for the door to unlock. During that time, the door cannot be opened. Twisting clockwise the Emergency Stop button restores power to the controller, which will display the remaining time of the cycle. The washer may be restarted by closing and latching the door, and pressing the Start button. If the Emergency Stop button is engaged for more than 1 hour, the cycle will be terminated.

### 2.4 VARIABLE FREQUENCY DRIVE INDICATORS

There are three small red LEDs located on the upper Variable Frequency Drive (VFD) cover. They are labeled as "READY", "RUN", and "FAULT" and can be used for troubleshooting. The definitions of the LEDs are listed in Table 4 below.



| Washer Condition                              | "READY"<br>LED<br>Status | "RUN"<br>LED Status | "FAULT"<br>LED<br>Status |
|---|--------------------------|---------------------|--------------------------|
| Idle Mode<br>(No Cylinder Movement)           | ON                       | OFF                 | OFF                      |
| Tumbling                                      | ON                       | ON                  | OFF                      |
| Stop from Tumble                              | ON                       | FLASHING            | OFF                      |
| Ramp to Intermediate or<br>Final Extract Spin | ON                       | ON                  | OFF                      |
| Spinning<br>(Intermediate or Final)           | ON                       | ON                  | OFF                      |
| Stop from Spin<br>(Intermediate or Final)     | ON                       | FLASHING            | OFF                      |
| Faulted                                       | ON                       | OFF                 | ON                       |

**Table 4: Variable Frequency Drive Indicators**

### 3 MACHINE PROGRAMMING INSTRUCTIONS

This Dexter washer is programmed with 6 factory default programs available for use immediately after installation. Any of these cycles, listed and detailed in section 3.2, can be customized to include up to 8 baths with various defined settings including Cycle Time, Water Temperature, Water Level, Type of Fill, Spin Time, and Injection Source. Programming can be accomplished manually using the machine controls or by connecting to the machine control using a PDA (**P**ersonal **D**igital **A**ssistant). For instructions on using a PDA with this washer control, please contact your local Dexter laundry equipment distributor. Please read below for manual programming instructions.

#### 3.1 EDITING AN EXISTING CYCLE

*3.1.1 Turn on the power to the washer.*

Washer must be in idle mode to program.

*3.1.2 Ensure washer is in "PROGRAM" mode.*

Locate the "RUN/PROGRAM" key switch and key. The current mode is indicated by the alignment of the key slot. If washer is not in "PROGRAM" mode, insert and turn the key to the "PROGRAM" position.

The display will show "C\_\_0". The "ADD BLEACH" light will blink and will continue to blink during the programming mode.

*3.1.3 Select cycle to alter.*

Press the "DOWN" or "UP" buttons on the keypad, as shown in Figure 3-1, until the desired cycle number, 01 through 06, is displayed.

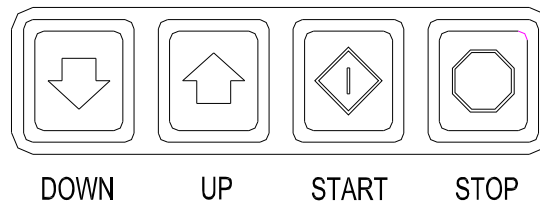

**Figure 3-1: Washer Control Keypad Layout**

*3.1.4 Press "START" to enter the cycle.*

The display should now show a "b".

*3.1.5 Select a bath to alter.*

Press the "UP" and "DOWN" buttons to select a bath. The mode indicator lights, as shown in Figure 3-2, illuminate to indicate which bath is being selected.



**Figure 3-2: Washer Mode Lights**

There are 8 available baths to program: FLUSH, PREWASH, WASH, RINSE1, RINSE 2, RINSE 3, RINSE 4, and FINAL RINSE.

When "RINSE" is illuminated, up to 4 rinses may be programmed. Each rinse is shown on the display as "b r1" through "b r4".

### 3.1.6 Press "START" to display the settings.

Available settings to alter in each bath are Cycle Time, Water Temp, Water Level, Type of Fill, Spin Time, and Injection Source.

### 3.1.7 Input settings.

The first setting to alter is the Cycle Time, shown on the display as "Ct\*\*" where \*\* is a placeholder for the options digits. Use the "DOWN" and "UP" keys to set the desired time in minutes and press "START" to advance to the next setting. If no change is desired, press "START" to advance to the next setting. Repeat process for each setting. Each bath setting can be programmed with the options shown in Table 5.

| SETTING                       | DISPLAY | OPTIONS  |
|-------------------------------|---------|--|
| Cycle Time                    | Ct**    | Two-digit amount of time for bath in minutes.<br>- 00 to 15 minutes for Flush, Prewash, Wash, Rinse 1, 2, 3 and 4. If the time is set to 00, then the bath will be eliminated from the cycle.<br>- 01 to 15 minutes for Final Rinse. |
| Water Temperature             | t_**    | HH for hot water<br>CH for warm water<br>CC for cold water<br>EE for no water <sup>2</sup>   |
| Water Level                   | L_**    | Lo for low level<br>HI for high level  |
| Type of Fill <sup>1</sup>     | dF_*    | d for delayed fill (default)<br>t for timed fill   |
| Spin Time                     | S_**    | Two-digit amount of time for spin in minutes.<br>- 00 to 10 minutes for Flush, Prewash, Wash, Rinse 1, 2, 3 and 4<br>- 01 to 10 minutes for Final Rinse  |
| Injection Source <sup>2</sup> | IS_*    | Single-digit code indicating injector signal(s), 0 to 6.   |

**Table 5: Bath Program Settings**

<sup>1</sup> A delayed fill will pause the cycle time countdown until the selected low level is reached. A timed fill will allow the cycle time countdown to continue regardless of water level reached.

<sup>2</sup> Codes for injections sources are defined in Table 3. When "EE" is selected in the Water Temperature setting, the electronic controller prohibits injection signals. The programmed injection source value is ignored.

### 3.1.8 To exit the programming of a bath, press the "STOP" button.

If desired, repeat steps 3.1.5 through 3.1.7 to program another bath.

### 3.1.9 To select a different cycle to program, press the "STOP" button again.

If desired, repeat steps 3.1.3 through 3.1.8 to program another cycle.



3.1.10 To end programming, turn the key to "RUN" position.

It is recommended when changes are made to one or more of the preset programs that the cycle number and the changes be documented for later reference. Blank cycle tables have been provided at the end of section 3.2.

**NOTE:** The Wash Cycle programming mode will automatically exit and return to the Idle mode if no buttons are pressed for one minute.

### 3.2 DEFAULT WASHER CYCLE PROGRAMS

The factory default cycles pre-programmed into the washer are listed with each bath and setting option in this section.

| <b>Cycle #</b> | <b>Recommended Use</b>                       |
|----------------|--|
| 1              | Sheets & Pillowcases (Health Care)           |
| 2              | Towels / Pads / Diapers (Health Care)        |
| 3              | White Towels (Hotel / Motel)                 |
| 4              | Guest Laundry (Hotel / Motel or Health Care) |
| 5              | Rags & Mops (Hotel / Motel)                  |
| 6              | Colored Cotton Linen (Food & Beverage)       |

**Cycle 1** Sheets & Pillowcases (Health Care)

| Bath        | Bath Cycle Time (min.) | Water Temp. | Water Level | Delay Fill | Spin Time (min.) | Injection Source |
|-------------|------------------------|-------------|-------------|------------|------------------|------------------|
| Flush       | 3                      | CH          | HI          | d          |                  |                  |
| Prewash     | 2                      | CH          | HI          | d          |                  |                  |
| Wash        | 7                      | HH          | LO          | d          |                  | 1 (Detergent)    |
| Rinse 1     | 7                      | HH          | LO          | d          |                  | 2 (Bleach)       |
| Rinse 2     | 2                      | CH          | HI          | d          | 1                |                  |
| Rinse 3     | 2                      | CH          | HI          | d          |                  |                  |
| Rinse 4     |                        |             |             |            |                  |                  |
| Final Rinse | 4                      | CH          | LO          | d          | 4                | 4 (Sour/Soft)    |

**Cycle 2** Towels / Pads / Diapers (Health Care)

| Bath        | Bath Cycle Time (min.) | Water Temp. | Water Level | Delay Fill | Spin Time (min.) | Injection Source |
|-------------|------------------------|-------------|-------------|------------|------------------|------------------|
| Flush       | 3                      | CH          | HI          | d          |                  |                  |
| Prewash     | 2                      | CH          | HI          | d          |                  |                  |
| Wash        | 7                      | HH          | LO          | d          |                  | 1 (Detergent)    |
| Rinse 1     | 1                      | HH          | HI          | d          |                  |                  |
| Rinse 2     | 7                      | HH          | LO          | d          |                  | 2 (Bleach)       |
| Rinse 3     | 2                      | CH          | HI          | d          | 1                |                  |
| Rinse 4     | 2                      | CH          | HI          | d          |                  |                  |
| Final Rinse | 4                      | CH          | LO          | d          | 5                | 4 (Sour/Soft)    |

**Cycle 3** White Towels (Hotel / Motel)

| Bath        | Bath Cycle Time (min.) | Water Temp. | Water Level | Delay Fill | Spin Time (min.) | Injection Source |
|-------------|------------------------|-------------|-------------|------------|------------------|------------------|
| Flush       |                        |             |             |            |                  |                  |
| Prewash     |                        |             |             |            |                  |                  |
| Wash        | 7                      | HH          | LO          | d          |                  | 1 (Detergent)    |
| Rinse 1     | 1                      | HH          | HI          | d          |                  |                  |
| Rinse 2     | 7                      | HH          | LO          | d          |                  | 2 (Bleach)       |
| Rinse 3     | 2                      | CH          | HI          | d          | 1                |                  |
| Rinse 4     | 2                      | CH          | HI          | d          |                  |                  |
| Final Rinse | 4                      | CH          | LO          | d          | 5                | 4 (Sour/Soft)    |

**Cycle 4** Guest Laundry (Hotel / Motel or Health Care)

| Bath        | Bath Cycle Time (min.) | Water Temp. | Water Level | Delay Fill | Spin Time (min.) | Injection Source     |
|-------------|------------------------|-------------|-------------|------------|------------------|----------------------|
| Flush       | 3                      | CH          | HI          | d          |                  |                      |
| Prewash     |                        |             |             |            |                  |                      |
| Wash        | 7                      | HH          | LO          | d          |                  | 5 (Detergent/Bleach) |
| Rinse 1     | 2                      | HH          | HI          | d          |                  |                      |
| Rinse 2     | 2                      | CH          | HI          | d          |                  |                      |
| Rinse 3     | 2                      | CH          | HI          | d          |                  |                      |
| Rinse 4     |                        |             |             |            |                  |                      |
| Final Rinse | 4                      | CH          | LO          | d          | 4                | 4 (Sour/Soft)        |

**Cycle 5** Rags & Mops (Hotel / Motel)

| Bath        | Bath Cycle Time (min.) | Water Temp. | Water Level | Delay Fill | Spin Time (min.) | Injection Source |
|-------------|------------------------|-------------|-------------|------------|------------------|------------------|
| Flush       | 3                      | CH          | HI          | d          |                  |                  |
| Prewash     | 2                      | CH          | HI          | d          |                  |                  |
| Wash        | 2                      | CH          | HI          | d          |                  |                  |
| Rinse 1     | 7                      | HH          | LO          | d          |                  | 1 (Detergent)    |
| Rinse 2     | 2                      | HH          | HI          | d          |                  |                  |
| Rinse 3     | 7                      | HH          | LO          | d          |                  | 2 (Bleach)       |
| Rinse 4     | 2                      | CH          | HI          | d          | 1                |                  |
| Final Rinse | 2                      | CH          | LO          | d          | 5                |                  |

**Cycle 6** Colored Cotton Linen (Food & Beverage)

| Bath        | Bath Cycle Time (min.) | Water Temp. | Water Level | Delay Fill | Spin Time (min.) | Injection Source |
|-------------|------------------------|-------------|-------------|------------|------------------|------------------|
| Flush       | 2                      | CH          | HI          | d          |                  |                  |
| Prewash     |                        |             |             |            |                  |                  |
| Wash        | 10                     | HH          | LO          | d          |                  | 1 (Detergent)    |
| Rinse 1     | 7                      | HH          | LO          | d          |                  | 2 (Bleach)       |
| Rinse 2     | 2                      | CH          | HI          | d          | 1                |                  |
| Rinse 3     | 2                      | CH          | HI          | d          |                  |                  |
| Rinse 4     |                        |             |             |            |                  |                  |
| Final Rinse | 4                      | CH          | LO          | d          | 4                | 6 (Sour/Starch)  |

**Cycle \_\_\_\_\_ Description \_\_\_\_\_**

| Bath        | Bath Cycle Time (min.) | Water Temp. | Water Level | Delay Fill | Spin Time (min.) | Injection Source |
|-------------|------------------------|-------------|-------------|------------|------------------|------------------|
| Flush       |                        |             |             |            |                  |                  |
| Prewash     |                        |             |             |            |                  |                  |
| Wash        |                        |             |             |            |                  |                  |
| Rinse 1     |                        |             |             |            |                  |                  |
| Rinse 2     |                        |             |             |            |                  |                  |
| Rinse 3     |                        |             |             |            |                  |                  |
| Rinse 4     |                        |             |             |            |                  |                  |
| Final Rinse |                        |             |             |            |                  |                  |

**Cycle \_\_\_\_\_ Description \_\_\_\_\_**

| Bath        | Bath Cycle Time (min.) | Water Temp. | Water Level | Delay Fill | Spin Time (min.) | Injection Source |
|-------------|------------------------|-------------|-------------|------------|------------------|------------------|
| Flush       |                        |             |             |            |                  |                  |
| Prewash     |                        |             |             |            |                  |                  |
| Wash        |                        |             |             |            |                  |                  |
| Rinse 1     |                        |             |             |            |                  |                  |
| Rinse 2     |                        |             |             |            |                  |                  |
| Rinse 3     |                        |             |             |            |                  |                  |
| Rinse 4     |                        |             |             |            |                  |                  |
| Final Rinse |                        |             |             |            |                  |                  |

**Cycle \_\_\_\_\_ Description \_\_\_\_\_**

| Bath        | Bath Cycle Time (min.) | Water Temp. | Water Level | Delay Fill | Spin Time (min.) | Injection Source |
|-------------|------------------------|-------------|-------------|------------|------------------|------------------|
| Flush       |                        |             |             |            |                  |                  |
| Prewash     |                        |             |             |            |                  |                  |
| Wash        |                        |             |             |            |                  |                  |
| Rinse 1     |                        |             |             |            |                  |                  |
| Rinse 2     |                        |             |             |            |                  |                  |
| Rinse 3     |                        |             |             |            |                  |                  |
| Rinse 4     |                        |             |             |            |                  |                  |
| Final Rinse |                        |             |             |            |                  |                  |

### 3.3 RAPID ADVANCE MODE

Rapid Advance mode is a key-controlled override to interrupt the current cycle, drain the water, and advance to the next mode of the wash cycle, including Pre Wash, Wash, Rinse, Final Rinse, and Spin. The indicator lights will show to which segment the cycle has been advanced.

To enter the Rapid Advance mode, turn the key counter-clockwise (CCW). The Rapid Advance setting is not marked next to the key, but turning the key CCW until it stops selects this mode. The Rapid Advance mode can be entered from either the Idle mode or during the cycle. If the cycle has not yet started, press the "START" button. To rapid advance to the next step in the wash cycle, push both the "UP" and "START" buttons at the same time. The display will show "Ad" (advance) in the display. The washer will advance to the next bath segment only after the water is drained from the washer.

**Note:**

- The time displayed may not be accurate.
- The cycle will continue in rapid advance mode even if the key is turned to "RUN" and/or removed.
- Rapid advance cannot skip the final 1-minute tumble of the cycle, and the door lock may remain activated for a couple minutes after the cycle has been completed.
- The chemical injection signals will NOT operate in Rapid Advance mode.

**To end the cycle without waiting for the time to count down, press and hold the "STOP" button for 5 seconds or more.**

### 3.4 WATER LEVEL ADJUSTMENT

The water level of all baths can be adjusted by changing the switch settings on the electronic pressure sensor. On-premise washers are shipped with the pressure sensor harness connected to Switch #1 for "LO" level and Switch #2 for "HI" level.

Water level adjustments can also be made in 1/4" increments by adjusting the switch positions for the desired level. It is not recommended for the water level to be set above the factory Switch #2 settings. Refer to the following chart for the switch settings and the factory default settings:

| Water Level Chart |       |       |       |       |       |       |                   |                          |                          |
|-------------------|-------|-------|-------|-------|-------|-------|-------------------|--------------------------|--------------------------|
| Switch Positions: |       |       |       |       |       |       | Factory Settings: |                          |                          |
| Depth (in):       | Pos 1 | Pos 2 | Pos 3 | Pos 4 | Pos 5 | Pos 6 | Model             | OPL                      |                          |
|                   |       |       |       |       |       |       |                   | Switch #1<br>Depth (in): | Switch #2<br>Depth (in): |
| 5.00              | off   | off   | off   | off   | off   | off   |                   |                          |                          |
| 5.25              | on    | off   | off   | off   | off   | off   |                   |                          |                          |
| 5.50              | off   | on    | off   | off   | off   | off   |                   |                          |                          |
| 5.75              | on    | on    | off   | off   | off   | off   |                   |                          |                          |
| 6.00              | off   | off   | on    | off   | off   | off   | T-300             | 6.00                     | 6.75                     |
| 6.25              | on    | off   | on    | off   | off   | off   | T-350             | 6.00                     | 6.75                     |
| 6.50              | off   | on    | on    | off   | off   | off   | T-400             | 8.00                     | 11.00                    |
| 6.75              | on    | on    | on    | off   | off   | off   | T-450             | 6.00                     | 8.50                     |
| 7.00              | off   | off   | off   | on    | off   | off   | T-450 SWD         | 6.00                     | 8.50                     |
| 7.25              | on    | off   | off   | on    | off   | off   | T-600             | 8.00                     | 11.00                    |
| 7.50              | off   | on    | off   | on    | off   | off   | T-650             | 8.00                     | 11.00                    |
| 7.75              | on    | on    | off   | on    | off   | off   | T-750             | 6.00                     | 8.75                     |
| 8.00              | off   | off   | on    | on    | off   | off   | T-750 SWD         | 9.25                     | 11.75                    |
| 8.25              | on    | off   | on    | on    | off   | off   | T-900             | 6.00                     | 8.75                     |
| 8.50              | off   | on    | on    | on    | off   | off   | T-950             | 6.00                     | 8.75                     |
| 8.75              | on    | on    | on    | on    | off   | off   | T-1200            | 6.00                     | 8.75                     |
| 9.00              | off   | off   | off   | off   | on    | off   | T-1450            | 6.75                     | 9.50                     |
| 9.25              | on    | off   | off   | off   | on    | off   |                   |                          |                          |
| 9.50              | off   | on    | off   | off   | on    | off   |                   |                          |                          |
| 9.75              | on    | on    | off   | off   | on    | off   |                   |                          |                          |
| 10.00             | off   | off   | on    | off   | on    | off   |                   |                          |                          |
| 10.25             | on    | off   | on    | off   | on    | off   |                   |                          |                          |
| 10.50             | off   | on    | on    | off   | on    | off   |                   |                          |                          |
| 10.75             | on    | on    | on    | off   | on    | off   |                   |                          |                          |
| 11.00             | off   | off   | off   | on    | on    | off   |                   |                          |                          |
| 11.25             | on    | off   | off   | on    | on    | off   |                   |                          |                          |
| 11.50             | off   | on    | off   | on    | on    | off   |                   |                          |                          |
| 11.75             | on    | on    | off   | on    | on    | off   |                   |                          |                          |
| 12.00             | off   | off   | on    | on    | on    | off   |                   |                          |                          |
| 12.25             | on    | off   | on    | on    | on    | off   |                   |                          |                          |
| 12.50             | off   | on    | on    | on    | on    | off   |                   |                          |                          |
| 12.75             | on    | on    | on    | on    | on    | off   |                   |                          |                          |
| 13.00             | off   | off   | off   | off   | off   | on    |                   |                          |                          |
| 13.25             | on    | off   | off   | off   | off   | on    |                   |                          |                          |
| 13.50             | off   | on    | off   | off   | off   | on    |                   |                          |                          |
| 13.75             | on    | on    | off   | off   | off   | on    |                   |                          |                          |
| 14.00             | off   | off   | on    | off   | off   | on    |                   |                          |                          |
| 14.25             | on    | off   | on    | off   | off   | on    |                   |                          |                          |
| 14.50             | off   | on    | on    | off   | off   | on    |                   |                          |                          |
| 14.75             | on    | on    | on    | off   | off   | on    |                   |                          |                          |
| 15.00             | off   | off   | off   | on    | off   | on    |                   |                          |                          |

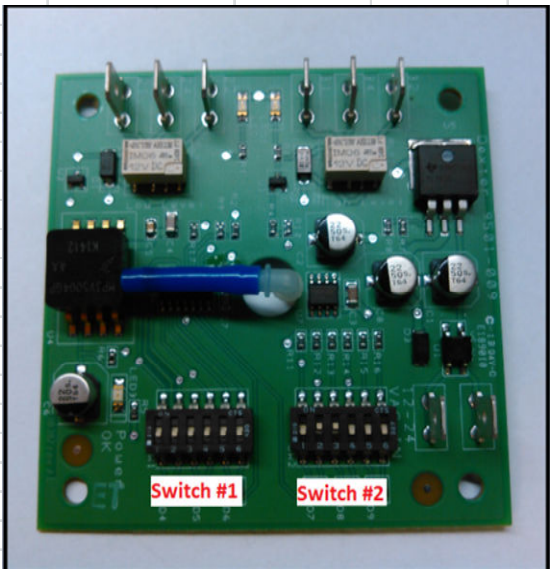

## 4 WASHER ERROR CODES

| Fault #<br>(F #) | Description  | Customer Action   |
|------------------|--|---|
| 1                | The door failed to close and lock or the door failed to remain locked after three tries of latching the door and starting during the cycle.  | Turn off the power to the washer. Check wire connections to door /lock switches. Check wire connections from switches to controller. If necessary door lock mechanism should be adjusted by a qualified person. Turn on the power to the washer. (See Note)                             |
| 2                | The washer tub does not fill with water within 7 minutes. The wash cycle will continue. The F 2 will flash three times, and then wait for 30 seconds. The error will clear at the end of the cycle.  | Turn of the power to the washer. Check the operation of the water valves. Check the incoming water pressure. Check for blocked or restricted water flow. Check to ensure the drain valve is functioning properly. Turn on the power to the washer. (See Note)                           |
| 3                | Memory error in controller.  | Turn off the power to the washer. Wait one minute. Turn power back on to the washer. If the problem returns, clear the fault with the Palm. If the problem returns again, replace the washer controller.  |
| 4                | Washer controller communication error  | Turn off the power to the washer. Wait one minute. Turn power back on to the washer. If the problem returns, replace the washer controller.   |
| 5                | Pressure Switch error ( only OPL )- when the high level sensor indicates full but the lower one indicates empty. The wash cycle will continue. The F 5 will flash three times, and then wait for 30 seconds. The error will clear at the end of the cycle. | Turn off the power to the washer. Replace the pressure switch. Turn on power to the washer. (See Note)  |
| 6                | Wrong washer size for drive type.  | Turn off the power to the washer. Check to ensure all the harnesses are properly connected to the controller. Check to ensure the drive horsepower is proper for this size of washer. Turn on power to the washer. (See Note) If problem reappears, contact your Dexter representative. |
| 7                | Wrong size drive installed   | Turn off the power to the washer. Check to ensure all the harnesses are properly connected to the controller. Check to ensure the drive horsepower is proper for this size of washer. Contact your Dexter representative.   |
| 8                | The washer tub does not empty within 7 minutes. The wash cycle will continue. The F 8 will flash three times, and then wait for 30 seconds. The error will clear at the end of the cycle.  | Turn off the power to the washer. Check to ensure the drain valve is operating properly. Check to ensure the pressure switch tube is clear of blockage. Check to ensure the pressure switch is operating proper. Correct any located problems. Turn on power to the washer. (See Note)  |
| 9                | The washer tub does not reach the spin target frequency within 200 seconds. The wash cycle will continue. The F 9 will flash three times, and then wait for 30 seconds. The error will clear at the end of the cycle.                                      | Turn off the power to the washer. Inspect the washer to ensure the tub spins freely. If restricted, then clear the blockage. Test washer. If tub spins freely, the drive needs to be replaced.  |
| 10               | After a spin the washer tub does not stop within 150 seconds.  | Turn off the power to the washer. Inspect the braking resistors and the connecting wiring to the drive braking resistors mounted in the top of the washer. If the resistors and wiring is correct, then replace the drive.  |

|    |   |  |
|----|---|--|
| 11 | The drive size setting has changed.                           | Turn off the power to the washer. Check to ensure all the harnesses are properly connected to the controller. Check to ensure the drive horsepower is proper for this size of washer. Turn on power to the washer. (See Note) If problem reappears, contact your Dexter representative.  |
| 12 | Washer controller internal error                              | Turn off the power to the washer. Wait one minute. Turn on the power to the washer. (See Note) If problem reappears, contact your Dexter representative.   |
| 13 | The control cannot communicate with the drive                 | Turn the power off to the washer. Check the data cable between the controller and the drive. If no problem is observed, turn on power to the washer and test. (See Note) If problem reappears, contact your Dexter representative.   |
| 14 | Over-current on the drive or motor.                           | Turn the power off to the washer. Check the washer motor to ensure it turns freely. Check the wiring connections to the drive and motor. If no problem is observed, turn on power to the washer and test. (See Note) If problem reappears, contact your Dexter representative.   |
| 15 | Over-voltage on the drive or motor.                           | Turn the power off to the washer. Check the washer motor to ensure it turns freely. Check the wiring connections to the drive, braking resistors and motor. Measure incoming line voltage. If no problem is observed, turn on power to the washer and test. (See Note) If problem reappears, contact your Dexter representative. |
| 16 | Overheating of the drive                                      | Turn the power off to the washer. Allow the drive to cool. Check the cooling fins of the drive to ensure proper airflow. Check the wiring to the drive including the fan wiring. If no problem is observed, turn on power to the washer and test. (See Note) If problem reappears, contact your Dexter representative.           |
| 17 | Overload of the drive or motor                                | Turn the power off to the washer. Check the washer motor to ensure it turns freely. Check the wiring connections to the drive and motor. If no problem is observed, turn on power to the washer and test. (See Note) If problem reappears, contact your Dexter representative.   |
| 18 | Earth Fault to the drive                                      | Turn the power off to the washer. Check the wiring connections to the drive and motor. Check the earth wiring of the drive, motor and incoming connection to ensure a proper earth is present. If no problem is found, contact your Dexter representative.   |
| 19 | Low Voltage to the drive                                      | Turn the power off to the washer. Check the wiring connections to the drive and motor. If no problem is observed, turn on power to the washer and test. (See Note) Measure the incoming line voltage. If problem reappears, contact your Dexter representative.  |
| 20 | Internal drive error  | Turn the power off to the washer. Wait one minute. Turn the power on to the washer. (See Note) If problem reappears, contact your Dexter representative.   |
| 21 | Data error on communications between the controller and drive | Turn the power off to the washer. Check the data cable between the controller and the drive. If no problem is observed, turn on power to the washer and test. (See Note) If problem reappears, contact your Dexter representative.   |

Note: Whenever power is turned off to the washer, it **must** remain off for one minute. The washer will not operate properly if this is not done.



## 5 TROUBLESHOOTING

**CAUTION:** Label all wires prior to disconnection when servicing controls. Wiring errors can cause improper and dangerous operation. Verify proper operation after servicing.

If any of the following symptoms occur on this washer, check the suggested remedies listed below. If all probable causes have been eliminated and the symptom still exists, contact your local Dexter agent for further troubleshooting assistance. See contact information at the end of this manual. Parts & Service Manuals from Dexter are also available for further troubleshooting assistance.

| Symptom                                    | Probable Cause               | Suggested Remedy   |
|--|------------------------------|--|
| <b>Machine does not start</b>              | Power Supply                 | Check these areas: Circuit breakers, Voltage, Power leads, Power connections. Is front display LED lit?  |
|  | Door Switch                  | Check for continuity through door switch when door is closed. If no continuity, adjust or replace door switch.   |
|  | Control Circuit Breaker      | Check 7 amp circuit breaker for continuity. If no continuity, replace circuit breaker.   |
|  | Control Transformer          | Check voltage output from control transformer for 24VAC. If voltage is incorrect, replace transformer.   |
|  | Check PCB board              | Check all wire connections for sure contacts.  |
|  | Check wiring between PCB     | Check data cable phone type connectors unplug and VFD and replug with power removed.   |
|  | Check Relay PCB              | Check all wire connections for sure contact.   |
|  | Check Door Lock Mechanism    | Check that 24VAC power is at mechanism after start button is pressed.  |
| <b>Door does not lock</b>                  | Check display for fault code | Does F1 show on the front of display? If yes, follow tests described in fault code section.  |
|  | Door locking mechanism       | Check to ensure that mechanism is receiving 24VAC from main relay PCB. If it is, replace.  |
|  | Door Switch                  | Check for continuity through door latch switch when door closed. If no continuity, adjust or replace door switch.  |
| <b>Door will not open</b>                  | Thermoactuator               | Check to see if thermoactuator(s) and/or its mechanism are stuck or binding and not allowing the door lock mechanism to open. Check to be sure that the locking thermoactuator is not receiving 24VAC during the last 1 1/2 minutes of the cycle. Also check to see that the unlocking thermoactuator is receiving 24VAC during the last minute of the cycle. If the thermoactuators do not receive voltage at the correct times, change the timer. If the timing and voltage are correct, replace the thermoactuator. |
| <b>Door will not open</b>                  | Door Rod                     | Check to see that door rod from mechanism to lock assembly is long enough to allow lock assembly to disengage. If not, adjust rod.   |
|  | Door locking mechanism       | Check that door lock mechanism is not stuck closed. If stuck, replace.   |
| <b>No hot water in detergent dispenser</b> | Water Valve Coil             | Check coil continuity at terminals and replace if no continuity. 24V power only on for 20 second in wash bath.   |
|  | Water Inlet                  | Check water inlet screens for blockage and clean screens if necessary.   |

|  |  |  |
|--|--|--|
| <b>No hot water in detergent dispenser</b>       | Water  | Check to ensure that water is turned on and operating.   |
|  | P-20 Wire Harness                                | Check black & white wire harness.  |
| <b>Hot water does not enter tub in wash</b>      | Water Valve Coil                                 | Check coil continuity at terminals and replace if no continuity. Check for 24V power from main relay PCB.  |
|  | Water Inlet                                      | Check water inlet screens for blockage and clean if necessary.   |
|  | Water  | Check to ensure that water is turned on and operating.   |
|  | Blk or Wht wire at main controller               | Check black or white wires at Molex plug on PCB at main controller and at relay PCB.   |
|  | Pressure Switch                                  | Check pressure switch continuity between terminals. If no continuity, check pressure switch hose for obstruction. If hose okay, change pressure switch.  |
| <b>No cold water to tub in wash</b>              | Water Valve Coil                                 | Check coil continuity at terminals and replace if no continuity.   |
|  | Water Inlet Screens                              | Check water inlet screens for blockage and clean if necessary.   |
|  | Water  | Check to ensure that water is turned on and operating.   |
|  | Blk or Wht wire at controller and main relay PCB | Check black or white wires at Molex plug on PCB at main controller and at relay PCB.   |
|  | Pressure Switch                                  | Check pressure switch continuity between terminal contacts. If no continuity, check pressure switch hose for obstruction. If hose okay, change pressure switch.  |
| <b>Water comes in but level does not rise</b>    | Drain Valve (open)                               | Check these areas: <ul style="list-style-type: none"> <li>• Drain valve blockage</li> <li>• Drain valve motor and gear train. If power but drain valve does not close, replace valve.</li> <li>• Power to the drain valve. If no power to drain valve, check (brn/yel) circuit for power.</li> </ul> |
|  | Blk or Wht wire at controller                    | Check black and white wires at Molex plug on main PCB controller and at main relay PCB   |
| <b>Water does not flush softener compartment</b> | Water Valve Coil                                 | Check coil continuity at terminals and replace if no continuity.   |
|  | Water Inlet Screens                              | Check water inlet screens for blockage and clean if necessary.   |
|  | Water  | Check to ensure that water is turned on and operating.   |
| <b>Water does not flush softener compartment</b> | Pressure Switch                                  | Check pressure switch continuity between terminals. If no continuity, check pressure switch hose for obstruction. If hose okay, change pressure switch.  |
| <b>Water level too high</b>                      | Pressure Switch                                  | Check for blockage in pressure switch hose. Check for pressure switch opening circuit across terminals. Replace switch if contacts do not open.  |
| <b>Water drains slowly</b>                       | Drain System                                     | Check hoses and drain valve for blockage. Check if inadequate size. If necessary check building drains for blockage.   |
| <b>Machine does not turn</b>                     | VFD  | Check VFD by removing inspection panel and record any numbers or letters displayed. If no display turn power off to machine at breaker for 2 minutes and turn power back on to reset. If still no display, replace VFD.  |

|  |                   |  |
|--|-------------------|--|
| <b>Machine tumbles in one direction</b>    | VFD               | Remove inspection cover at rear and record in only numbers or letters displayed. See fault code section for more info.   |
|  |                   | Inspect yellow enable wires from main relay PCB and at VFD.  |
| <b>Excessive vibration</b>                 | Mounting System   | Check these areas: • Strength of mounting structure, concrete or base. • Mounting bolts may be loose and need tightening.  |
|  | Drive Belt        | Worn drive belt can cause vibration and noise.   |
|  | Loading           | Note: Small loads contribute to out of balance loading and increase vibration.   |
| <b>Machine does not spin</b>               | Pressure Switch   | Check pressure switch for continuity across terminals #21 & #22 indicating pressure switch has reset to the empty position. If no continuity, change pressure switch.  |
| <b>Machine starts and does not operate</b> | VFD               | Check yellow enable wires from relay PCB P13 & motor P14to VFD advances through cycle are connected. Check fault code on VFD before removing power from the drive. Check orange P-15 wire for signal from door switches.   |
| <b>Machine does not stop</b>               | Main PCB          | Main PCB controls time cycle at end of cycle   |
|  | Braking Resistors | Check braking resistors for continuity. Verify ohms resistance by Molex.   |
| <b>Water leakage around loading door</b>   | Door Adjustment   | Door may need adjustment due to abuse or wear. Check tightness around perimeter using a dollar bill. Adjust left to right tightness by shims at door lock or hinge side. It is important to center gasket to tub opening before tightening door to hinge bolts. Chalk may be used on tub front to show point of contact with tub. If gasket is deformed, worn, or damaged, replace. Refer to parts section for door gasket expander kit. |

# **IMPORTANT**

## **TRANSIENT VOLTAGE SURGE SUPPRESSORS**

Like most electrical equipment your new machine can be damaged or have its life shortened by voltage surges due to lightning strikes which are not covered by factory warranty. Local power distribution problems also can be detrimental to the life of electrical components. We recommend the installation of transient voltage surge suppressors for your new equipment. These devices may be placed at the power supply panel for the complete installation and don't require an individual device for each machine.

These surge protectors help to protect equipment from large spikes and also from small ongoing spikes in the power that occur on a day to day basis. These smaller surges can shorten overall life of electrical components of all types and cause their failure at a later date. Although they can't protect against all events, these protective devices have a good reputation for significantly lengthening the useful life of electronic components. Electronic components are helped to have a longer useful life when they are supplied with the clean stable electrical power they like.

We are including the following names and phone numbers of a few suppliers of these devices for those who don't currently have a source.

| <u>MANUFACTURER</u>   | <u>CONTACT</u> | <u>PHONE</u>  |
|---|----------------|---|
| Innovative Technology, Inc<br>(Part of Eaton Corporation)   | Distributor    | 1-800-809-2772 or<br><a href="http://www.itvss.com">www.itvss.com</a>       |
| EFI Electronics Corporation<br>(Part of Schneider Electric) | Factory        | 1-800-877-1174  |
| MCG Surge Protection  | Factory        | 1-800-851-1508 or<br><a href="http://www.mcgsurge.com">www.mcgsurge.com</a> |
| Advanced Protection<br>Technologies Inc.                    | Factory        | 1-800-237-4567 or<br><a href="http://www.aptsurge.com">www.aptsurge.com</a> |

## 6 SERVICE AND PARTS

The following parts are provided with each machine for use in installation.

| <u>Dexter Part Number</u> | <u>Description</u>              | <u>Quantity</u> |
|---------------------------|---------------------------------|-----------------|
| 9990-027-015              | Hose, Water Supply Red          | 1               |
| 9990-027-016              | Hose, Water Supply Blue         | 1               |
| 9990-027-017              | Hose, Water Supply Red (Large)  | 1               |
| 9990-027-018              | Hose, Water Supply Blue (Large) | 1               |
| 8641-242-000              | Washer, Inlet Hose              | 4               |
| 9565-003-001              | Strainer, Inlet Hose            | 4               |

Contact distributor or Dexter Laundry, Inc. if a steel-mounting base is required.

### COMMON SERVICE PARTS

| Part Description                | Dexter Part Number |
|---------------------------------|--------------------|
| Circuit Breaker – 7A.           | 5198-211-002       |
| Motor – 3hp                     | 9376-329-001       |
| Drive – Variable Frequency, 5hp | 9375-028-020       |
| Belts - Drive                   | 9040-079-003       |
| PCB Assembly – Control/Display  | 9473-004-008       |
| Valve – Water, Dual             | 9379-183-013       |
| Valve – Water, Single           | 9379-194-003       |
| Valve – Drain, 3" Ball          | 9379-202-002       |
| Switch – Door Closure           | 9539-492-001       |

For service and parts information, contact your local Dexter agent. To find your local Dexter agent, use the Distributor Locator at the website shown below. If a Dexter agent is not available, contact **Dexter Laundry, Inc.** directly as listed below:

Mailing Address: 2211 West Grimes Avenue Phone: 1-800-524-2954  
Fairfield, IA 52556  
USA

Website: [www.dexter.com](http://www.dexter.com)



| <b>EC DECLARATION OF CONFORMITY<br/>WITH COUNCIL DIRECTIVE 2006/42/EC</b>  |   | <b>CE</b>  |
|--|---|--|
| Directive:   | Machinery Directive on machinery safety, 2006/42/EC   |  |
| Conforming Machinery:  | Commercial Washing System<br>Model Numbers: WN0300, WN0350, WN0400, WN0450, WNS450, WN0600, WN0650, WN0750, WNS750, WN0900, WN0950, WN1200, WN1450<br>Serial Numbers: |  |
| Manufacturer:  | Dexter Laundry, Inc.<br>2211 West Grimes Avenue<br>Fairfield, IA 52556 USA  |  |
| Harmonised Standards Referenced or Applied:  | EN ISO 12100:2010   | Safety of machinery. General principles for design. Risk assessment and risk reduction.                        |
|  | EN 349:1993+ A1:2008  | Safety of machinery. Minimum gaps to avoid crushing of parts of the human body.                                |
|  | EN 614-1:2006+ A1:2009  | Safety of machinery. Ergonomic design principles. Terminology and general principles.                          |
|  | EN 953:1997+ A1:2009  | Safety of machinery. Guards. General requirements for the design and construction of fixed and movable guards. |
|  | EN 1037:1995+ A1:2008   | Safety of machinery. Prevention of unexpected start-up.  |
|  | EN ISO 13857:2008   | Safety of machinery. Safety distances to prevent hazard zones being reached by upper and lower limbs.          |
|  | EN ISO 14119:2013   | Safety of Machinery. Interlocking devices associated with guards. Principles for design and selection.         |
|  | EN ISO 10472-1:2008   | Safety requirements for industrial laundry machinery. Common requirements.                                     |
|  | EN ISO 10472-2:2008   | Safety requirements for industrial laundry machinery. Washing machines and washer- extractors.                 |
|  | EN 60335-1:2012/ AC:2014  | Safety of machinery. Electrical equipment of machines. General requirements.                                   |
| Specifications with which Conformity is Declared:  | Essential Health and Safety Requirements of Annex1 of the Machinery Directive   |  |
| We hereby certify that the machinery described above conforms with the essential health and safety requirements of Council Directive 2006/42/EC on the approximation of the laws of the Member States relating to the safety of machinery. |   |  |
| Date:  |   |  |
| Signed:  |   |  |
| Signatory:   | Mark Cox<br>Director of Engineering   |  |





| <b>EC DECLARATION OF CONFORMITY<br/>WITH COUNCIL DIRECTIVE 2004/108/EC</b>  |  | <b>CE</b>   |
|---|--|---|
| Directive:  | Electromagnetic Compatibility Directive 2004/108/EC  |   |
| Conforming Machinery:   | Commercial Washing System<br>Model Numbers: WN0300, WN0350, WN0400, WN0450, WNS450, WN0600, WN0650, WN0750, WNS750, WN0900, WN0950, WN1200, WN1450 |   |
| Manufacturer:   | Dexter Laundry, Inc.<br>2211 West Grimes Avenue<br>Fairfield, IA 52556 USA   |   |
| Harmonised Standards Referenced or Applied:   | EN 55014-1:2006/A2:2011<br>CISPR 14-1:2005/A2:2011   | Electromagnetic compatibility. Requirements for household appliances, electric tools and similar apparatus. Emission.   |
|   | EN 55014-2:1997/A2:2008<br>CISPR 14-2:1997/A2:2008   | Electromagnetic compatibility. Requirements for household appliances, electric tools and similar apparatus. Immunity. Product family standard.  |
|   | EN 61000-3-2:2014  | Electromagnetic compatibility (EMC). Limits for harmonic current emissions (equipment input current $\leq 16A$ per phase).  |
|   | EN 61000-3-3:2013  | Electromagnetic compatibility (EMC). Limitation of voltage changes, voltage fluctuations and flicker in public low- voltage supply systems for equipment with rated current $\leq 16A$ per phase and not subject to conditional connection. |
| Specifications with which Conformity is Declared:   | Electromagnetic Compatibility Directive  |   |
| We hereby certify that the machinery described above conforms with the essential requirements of Council Directive 2004/108/EC on the approximation of the laws of the Member States relating to the electromagnetic compatibility. |  |   |
| Date:   |  |   |
| Signed:   |  |   |
| Signatory:  | Mark Cox<br>Director of Engineering  |   |

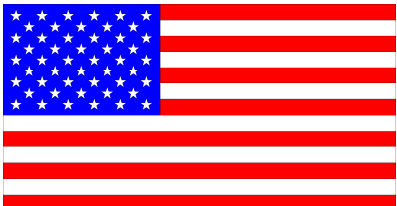

## Declaration of Noise Emission

The Dexter Laundry Commercial Washing System Models Sound Pressure Levels per EN ISO 11202 as measured on similarly constructed models are as follows:

| <b>Model</b> WCAD40KCB-59CN   | <b>Operating</b>  | <b>Idle</b>   |
|---|---|---|
| <b><math>L_{pAm}</math></b> (Operator Position)   | 64 dB (A)   | 51 dB (A)   |
| <b><math>L_{pAm}</math></b> (Bystander Position)  | 69 dB (A)   | 51 dB (A)   |
| <p>Ambient Correction Factor K3A calculated according to EN ISO 11204 Appendix A. <span style="float: right;">4 dB( A)</span></p> <p>Measurements were made at a height of 1.5 m and 1 m from the Operator Position and Bystander positions.</p> <p>The difference between the extraneous noise level and the sound intensity level at each measuring point is: <span style="float: right;"><b><math>L_{pAm} \Delta = 13</math> dB (A)</b></span></p> <p>The figures quoted are emission levels and are not necessarily safe working levels. While there is a correlation between the emission and exposure levels this cannot be used reliably to determine whether or not further precautions are required.</p> <p>Factors that influence the actual level of exposure of the workforce include characteristics of the work room, the other sources of noise, etc. such as the number of machines and other adjacent processes. Also, the permissible level of exposure can vary from country to country.</p> <p>This information, however, will enable the user of the machine to make a better evaluation of the hazard and risk.</p> |   |   |
|    | Dexter Laundry<br>2211 West Grimes Avenue<br>Fairfield, IA 52556<br>USA |  |