



DEXTER[®]
LAUNDRY



C-Series Vended Washers
WC_50XA-12EC_X





WC0650XA-12EC_X
WC0750XA-12EC_X
WC0950XA-12EC_X
WC1450XA-12EC_X

Before Serial # W1.19227.073
Before Serial # W1.19246.001
Before Serial # W1.19224.012
Before Serial # W1.19200.007

Express (200G)

Equipment Safety Warnings

Symbols and Terminology Used in this Equipment

⚠ DANGER	Indicates an imminently hazardous situation, which if not avoided, will result in death or serious injury.
⚠ WARNING	Indicates a potentially hazardous situation, which if not avoided could result in death or serious injury.
⚠ CAUTION	Indicates a potentially hazardous situation which, if not avoided, may result in minor or moderate injury. It may also be used to alert against unsafe practices. Minor burns, pinch points that result in bruises and minor chemical irritation.
NOTICE	Indicates information or a company policy that relates directly or indirectly to the safety of personnel or protection of property.
	This is the user caution symbol. It indicates a condition where damage to the equipment resulting in injury to the operator could occur if operational procedures are not followed. TO REDUCE THE RISK OF DAMAGE OR INJURY, refer to accompanying documents; follow all steps or procedures as instructed.
	This is the electrical hazard symbol. It indicates that there are DANGEROUS HIGH VOLTAGES PRESENT inside the enclosure of this product. TO REDUCE THE RISK OF FIRE OR ELECTRIC SHOCK, do not attempt to open the enclosure or gain access to areas where you are not instructed to do so. REFER SERVICING TO QUALIFIED SERVICE PERSONEL ONLY
	Caution! There are sharp edges on various sheet metal parts internal to the enclosure. Use safety consciousness when placing or moving your hands while working in the interior of this equipment.
	Caution! To reduce the risk of damage to the Water Inlet Valve, do not supply inlet water with a temperature that exceeds 70° C.
	Caution! To reduce the risk of fire or explosion, do not operate this equipment in any hazardous classified (ATEX) environment.

Equipment Safety Warnings

Symbols and Terminology Used in this Equipment



Warning! Do not operate equipment if door glass is damaged in any way.



Warning! Keep clear of rotating parts.



Prohibited! Do not enter this equipment or space.



Prohibited! Do not step or stand on this equipment.



Prohibited! Do not operate without all guards and covers in place.









Prohibited! Do not operate without all guards and covers in place.



Prohibited! Do not wash clothing impregnated with flammable liquids (petrochemical).



Prohibited! Do not allow children to play in or around equipment.

	<p>Indicates an imminently hazardous situation, which if not avoided, <u>will result</u> in death or serious injury.</p>
	<p>Indicates a potentially hazardous situation, which if not avoided <u>could result</u> in death or serious injury.</p>
	<p>Indicates a potentially hazardous situation which, if not avoided, <u>may result</u> in minor or moderate injury. It may also be used to alert against unsafe practices. Minor burns, pinch points that result in bruises and minor chemical irritation.</p>
<p>NOTICE</p>	<p>Indicates information or a company policy that relates directly or indirectly to the safety of personnel or protection of property.</p>
	<p>This is the user caution symbol. It indicates a condition where damage to the equipment resulting in injury to the operator could occur if operational procedures are not followed. TO REDUCE THE RISK OF DAMAGE OR INJURY, refer to accompanying documents; follow all steps or procedures as instructed.</p>
	<p>This is the electrical hazard symbol. It indicates that there are DANGEROUS HIGH VOLTAGES PRESENT inside the enclosure of this product. TO REDUCE THE RISK OF FIRE OR ELECTRIC SHOCK, do not attempt to open the enclosure or gain access to areas where you are not instructed to do so. REFER SERVICING TO QUALIFIED SERVICE PERSONEL ONLY</p>
	<p>Caution! To reduce the risk of fire or explosion, do not operate this equipment in any hazardous classified (ATEX) environment.</p>



WARNING



- All washers must be installed in accordance to all applicable electrical, plumbing and all other local codes.

- These installation and operation instructions are for use by qualified personnel only. To avoid injury and electrical shock, do not perform any servicing other than that contained in the installation and operation instructions, unless qualified.



Do not install washers in an explosive atmosphere.



- Care must be stressed with all foundation work to ensure a stable unit installation, eliminating possibilities of excessive vibration.

- Foundation must be level within 13 mm to ensure proper washer operation.



Do not operate washer if door glass is damaged in any way.



Do not wash clothing impregnated with flammable liquids (petrochemical).



WARNING







	<p>Children should be supervised to ensure they do not operate or play in or around equipment.</p>
	<p>Keep all panels in place to protect against electrical shock and injury and add rigidity to washer.</p>

This appliance is not intended for use by persons (including children) with reduced physical, sensory or mental capabilities, or lack of experience and knowledge, unless they have been given supervision or instruction concerning use of the appliance by a person responsible for their safety.

A washer should not be allowed to operate if any of the following occur:

- **Excessive high water level.**
- **Machine is not connected to a properly earthed circuit.**
- **Door does not remain securely locked during the entire cycle.**
- **Vibration or shaking from an inadequate mounting or foundation**

	<p>Warning! Do not operate equipment if door glass is damaged in any way.</p>
	<p>Warning! Keep clear of rotating parts.</p>
	<p>Prohibited! Do not enter this equipment or space.</p>
	<p>Prohibited! Do not step or stand on this equipment.</p>
	<p>Prohibited! Do not operate without all guards and covers in place.</p>
	<p>Prohibited! Do not operate without all guards and covers in place.</p>
	<p>Prohibited! Do not wash clothing impregnated with flammable liquids (petrochemical).</p>
	<p>Prohibited! Do not allow children to play in or around equipment.</p>

	<p>Prohibited! Do not attempt to open, touch, or proceed before referring to the manual or unless qualified.</p>
	<p>Mandatory! Read all supporting documentation before operating or maintaining equipment.</p>
	<p>Mandatory! Disconnect power before servicing equipment.</p>
	<p>Mandatory! Lock out and tag out before servicing this equipment.</p>
	<p>Mandatory! Disconnect water supply before servicing equipment.</p>
	<p>Mandatory! Children should be supervised to ensure they do not operate equipment.</p>

Dexter Safety Guidelines



WARNING

These washers are equipped with devices and features relating to their safe operation. To avoid injury or electrical shock, do not perform and service, unless qualified to do so.

FOR SAFETY

1. Always shut off power and water supply and also discharge capacitors before servicing.
2. Do not overload the washer.
3. Do not attempt to open door if cylinder is in motion or contains water.
4. Do not mechanically force or override door lock in any way.
5. Do not bypass any safety devices of this washer.
6. Do not use volatile or flammable substances in or near this washer.
7. Keep all panels in place. They protect against shock and injury and add rigidity to the washer.

A machine should not be allowed to operated if any of the following occur:

- Excessively high water level.
- Machine is not connected to a properly grounded circuit.
- Loading door does not remain securely locked during the entire cycle.
- Vibration or shaking from an inadequate mounting or foundation.

To activate your warranty, be sure to return your red warranty form to the factory. Please have serial number and model ready when calling for assistance.

Table of Contents

Section 1: Machine Mounting & Installation

T-650	15
T-750.....	15
T-950 & T-1450	16
T-650 Installation	17
T-750 Installation	18
T-950 Installation	19
T-1450 Installation.....	20

Section 2: Machine Installation & Operating Instructions

Basic Installation.....	24
Electrical Connections & Fusing Requirements .	25
Emergency Stop Button	26
Machine Operating Instructions	26 & 27
Detergent Measurements by Model.....	27

Section 3: Machine Programming Instructions

Dexter Live Programing.....	30-39
Programming Instructions & Price Programming.....	40-55

Section 4: Trouble Shooting

Common Troubleshooting Solutions Pages..	58-60
Troubleshooting Machine Fault Errors Pages.....	61-69
Motor Resistance Chart.....	70

Section 5: Machine Service Procedures

Lower Service Panel Removal	72
Top Panel Removal.....	72
Front Panel Removal	72
Back Panel Removal.....	72
Drain Valve Access.....	72
Drain Valve Cleaning	72
Detergent Dispenser	72

Vacuum Breaker/	
Air Gap.....	74
Water Valves	74
Door Lock Assembly Operation	75
Adjustment for the Door Lock	
Assembly	75 & 76
Adjusting the Loading Door	77
Loading Door Removal	77
Loading Door Hinge Removal.....	77
Loading Door Disassembly	78
Loading Door Reassembly	78
Control Panel Name Plate Decal.....	78
Name Plate Removal	78
Re-Installation of Name Plate.....	78
Outer Cabinet Removal	79
Door Locking Solenoid	80
Thermoactuators	80
Lock Thermoactuator	80
Unlock Thermoactuator	80
Drive Belt Removal.....	80
Tub Back, Bearing and Cylinder Assembly	71
Basket Pulley, Bearing Housing,	
Water Seals & Tub Back	80-83
T-750, T-900, T-950, T-1200 & T-1450	
Bolt Torque Chart	84

Section 6:

Control Mounting Trough.....	88
Main Data Communication Cable.....	88
Circuit Breaker/Fuse	88
Main Control Printed Circuit Board.....	88
PCB Transformer Step Down.....	88
Controls Transformer.....	88
Main Relay Printed Circuit Board	88
LED Printed Circuit Board Temperature & Start/	
Display Push Button.....	88
Pressure Switch	89
Electronic Pressure Senser	90-91
Power Connection Terminal Block	92
Emergency Stop Button & Switch Assembly.....	92
Delta Variable Frequency Drive	92
Delta VFD Motor Leads.....	92

Delta VFD Dynamic Braking	
Resistors	92
Delta VFD Cooling Fan	92

Section 7:

Machine Electrical & Wiring Schematics	
Start Circuit	94
Fill Circuit	94
Wash Circuit	95
Drain, Rinse 1 & 2 & Final Rinse Circuit	95
Extract Circuit.....	95
Thermoactuator and Shake Out Circuit.....	95
End of Cycle Circuit	96
Diagrams & Schematics.....	98 & 99

Section 8: Parts Data

C-Series Accessories.....	102
Wiring Harness Part # by Model.....	103
Cabinet and Front Panel Group Part #	
by Model	104 & 105
Soap Dish.....	106 & 107
Rear View Access Part # by Model.....	108 & 109
Cylinder, Seals & Bearings Part #	
by Model	110 & 111
Door Lock Part # by Model	112 & 113
Loading Door Part # by Model	114 & 115
Water Inlet Part # by Model.....	116-120
Water Hose Routing.....	121 & 122
Water Inlet Valve Breakdown I.....	123 & 124
Drain Valve Group Part # by Model.....	115
Chassis and Drain Part # by Model	127 & 128
Electrical Components -	
Top Compartment	129 & 130
Control Panel Part # by Model.....	131 & 132
Labels and Diagrams All WCAD Models	133

Section 9:

Coin Handling

Optical Switch.....134
Imonex135
Munzpurfer Electronic + Troubleshooting...137-141
Diagrams & Schematics 142-149

Section 10:

50 Hz Models

-39 Parts.....152 & 154
50HZ Diagrams & Schematics.....156-163

Section 11:

Maintenance

Preventative Maintenance166

Section 1:

Machine Mounting

Specifications for below models are outlined in this book:

WC0650-XA12ECX 208-240 volts 60hz. Single Phase or Three Phase

WC0750-XA12ECX 208-240 volts 60hz. Single Phase or Three Phase

WC0950-XA12ECX 208-240 volts 60hz Single Phase or Three Phase

WC1450-XA12ECX 208-240 volts 60hz Single Phase or Three Phase

T-650 Machine Dimensions

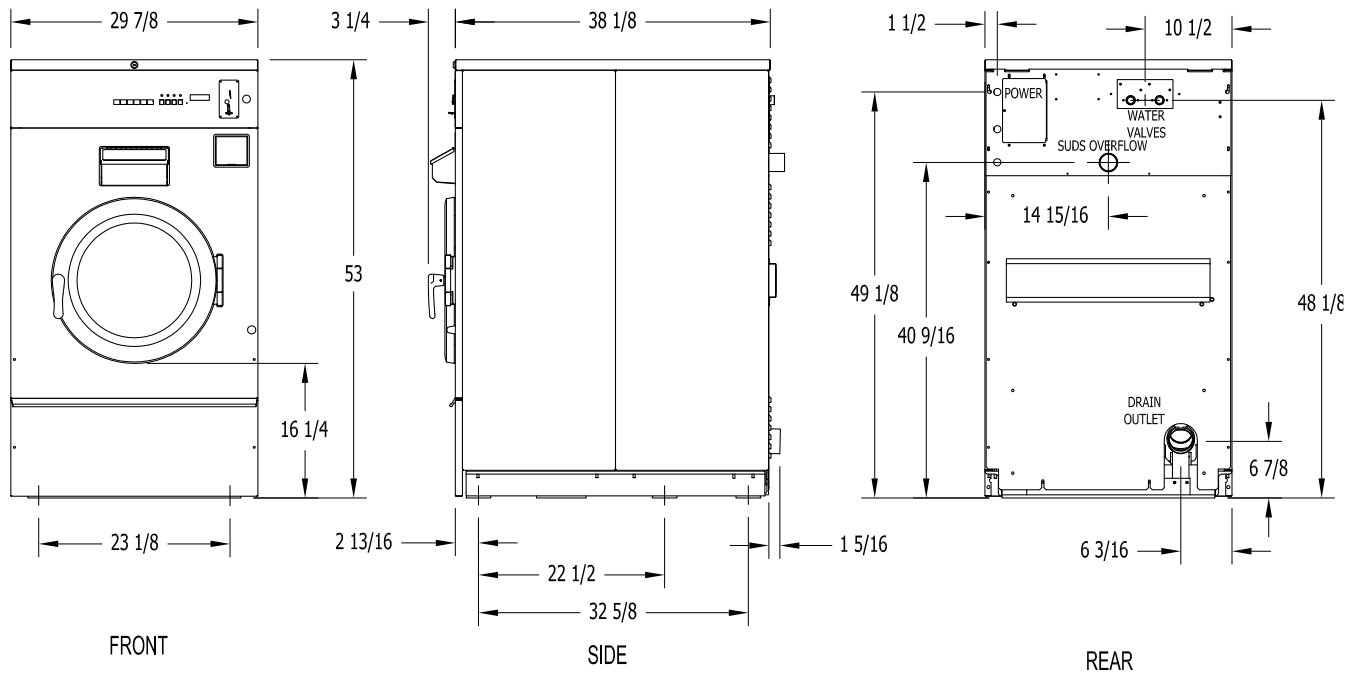

T-750 Machine Dimensions

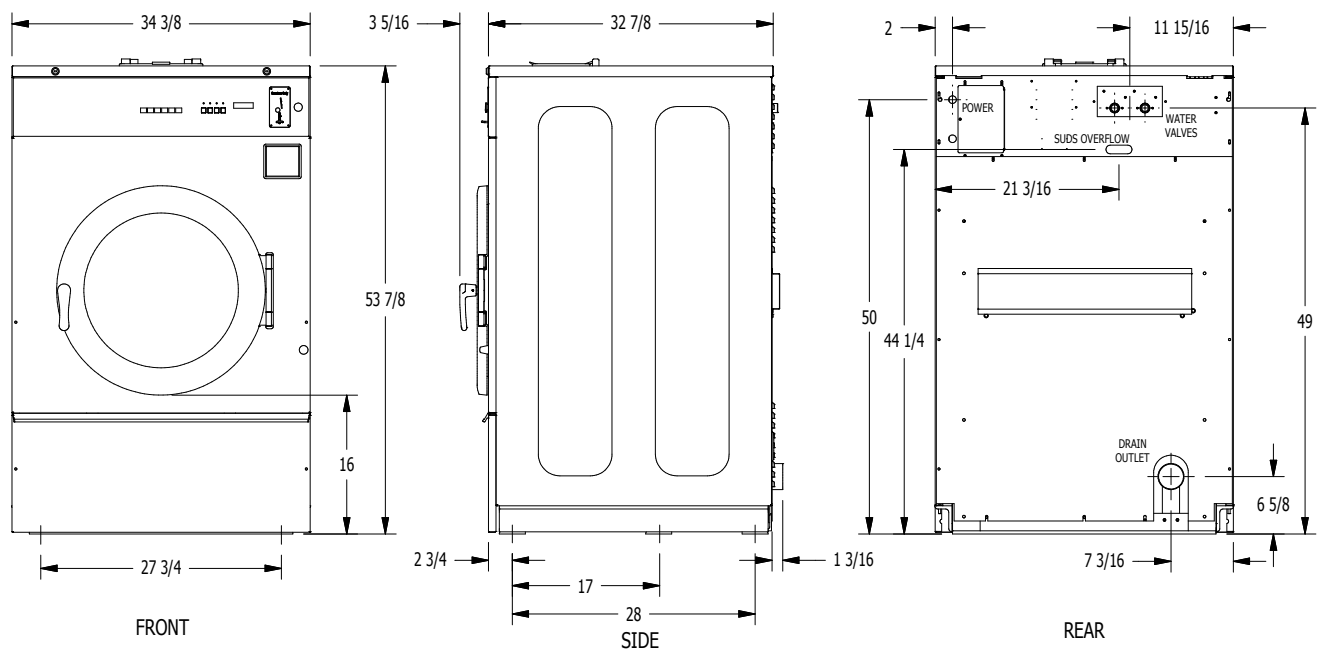

T-950 Machine Dimensions

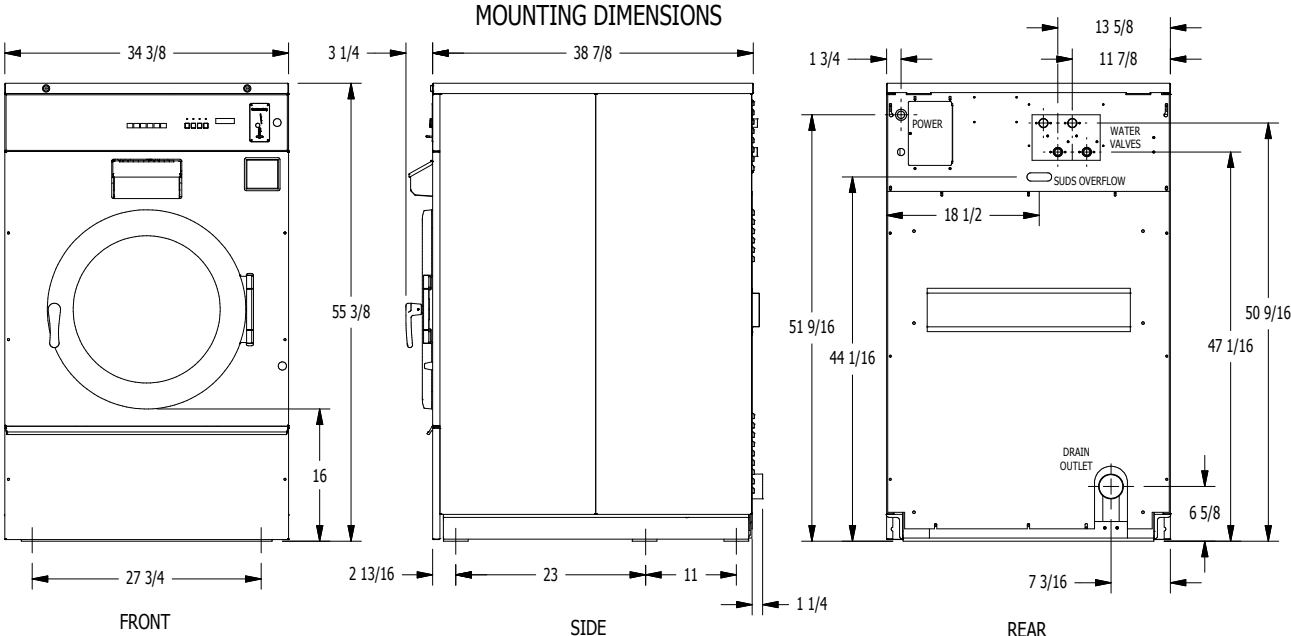

T-1450 Machine Dimensions

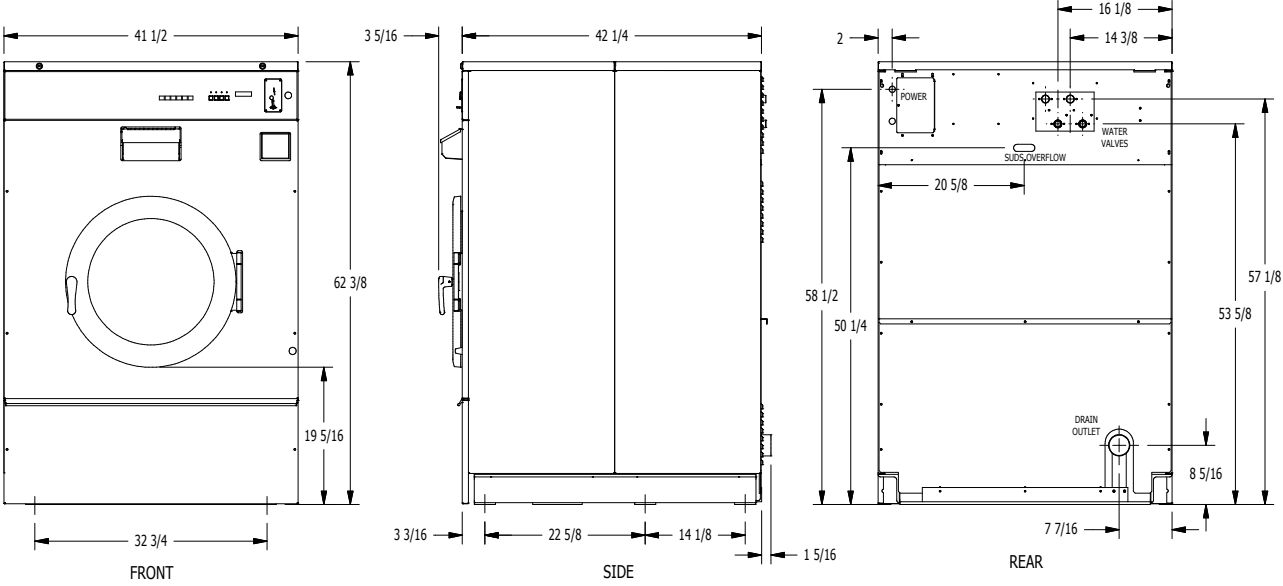

T-650 Mounting Dimensions

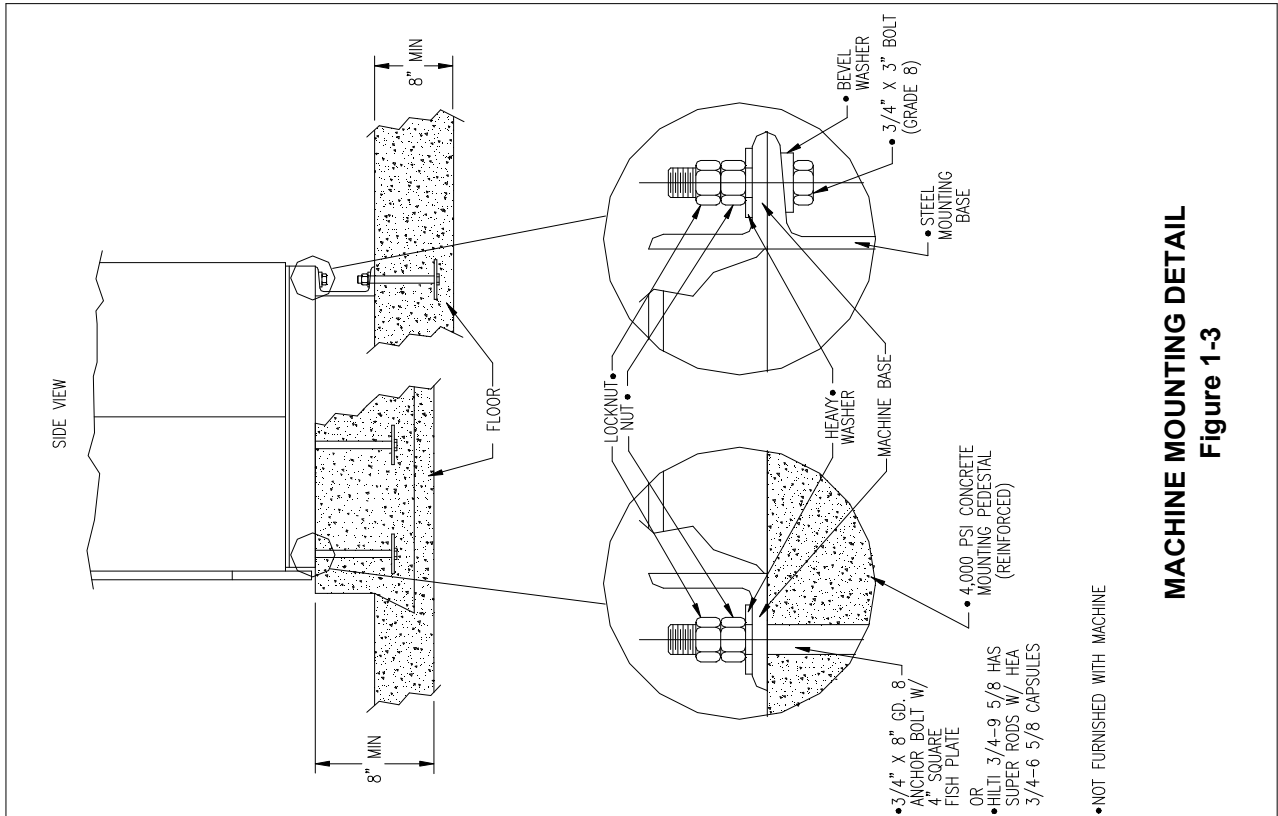

3/4" X 8" GD. 8 BOLTS
HEADED BY 4" SQ. FISH PLATE OR EQUIV.

OR

'HILTI' ADHESIVE ANCHORING SYSTEM.
USE HILTI 'HEA' 3/4-6 5/8 ADHESIVE CAPSULES
AND HILTI 'HAS' SUPER RODS 3/4-9 5/8
FOR MORE INFORMATION CALL
HILTI CUSTOMER SERVICE
1-800-879-8000

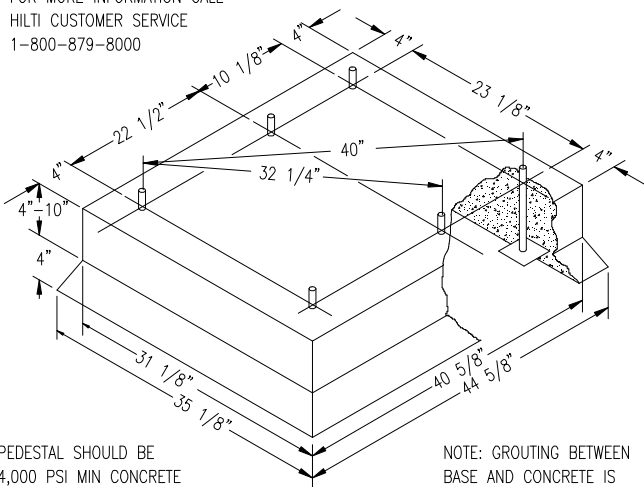

PEDESTAL SHOULD BE
4,000 PSI MIN CONCRETE
REINFORCED WITH
MESH OR RODS.

NOTE: GROUTING BETWEEN
BASE AND CONCRETE IS
REQUIRED.

CONCRETE PEDESTAL MOUNTING
Figure 1-1

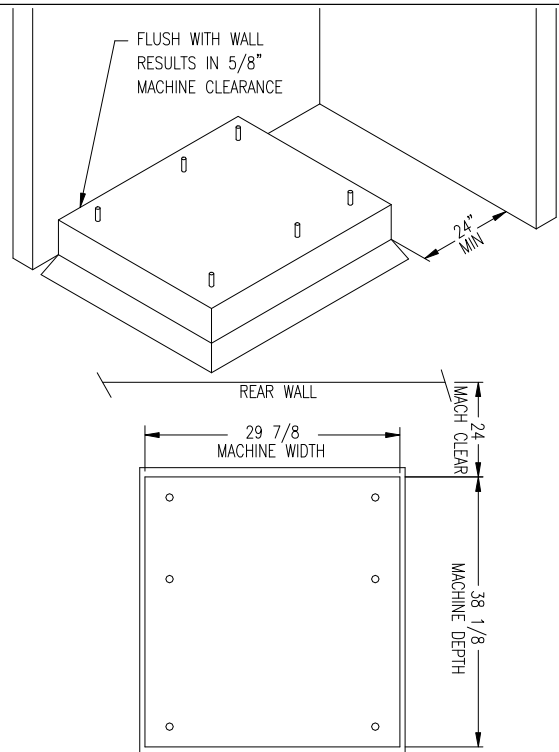

FLOOR OUTLINE
Figure 1-2

T-750 Mounting Dimensions

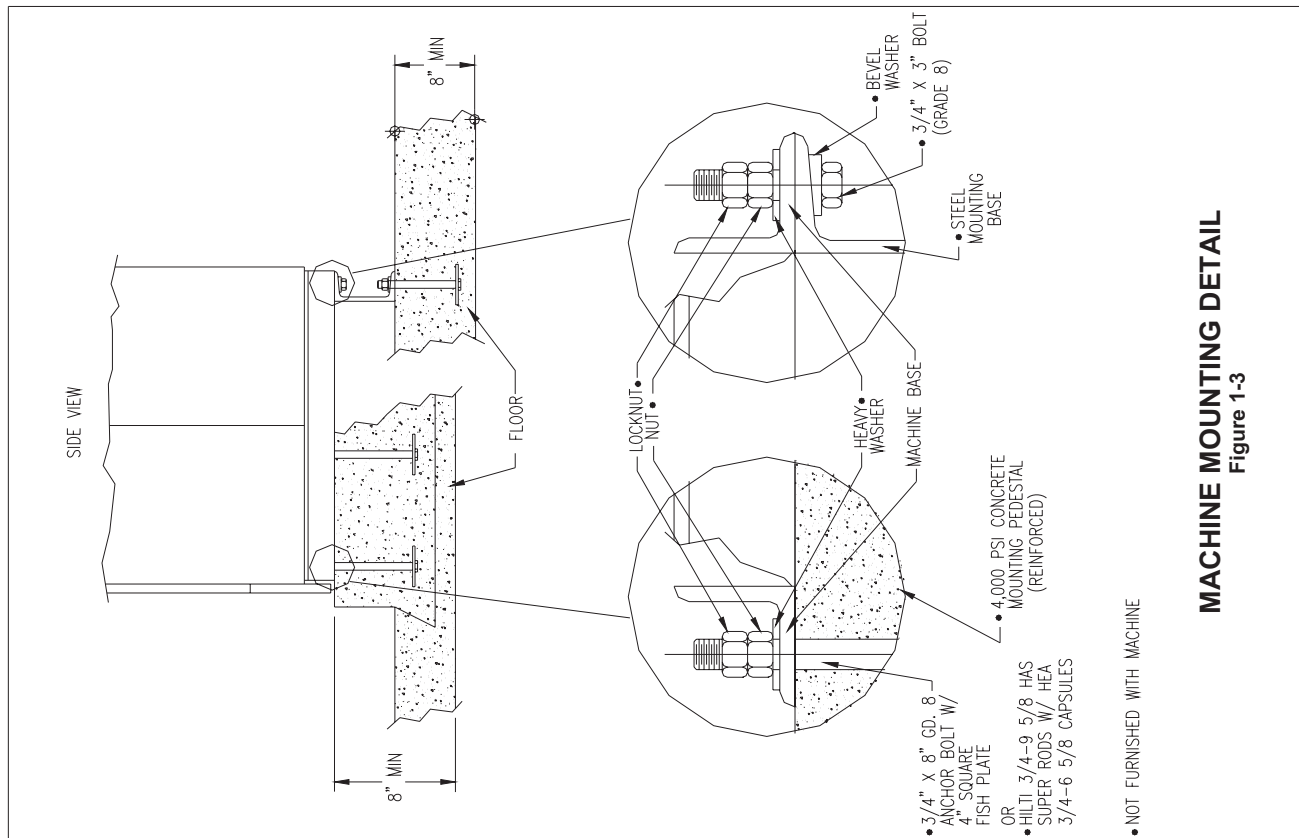

3/4" X 8" GD. 8 BOLTS
HEADED BY 4" SQ. FISH PLATE OR EQUIV.

OR

'HILTI' ADHESIVE ANCHORING SYSTEM.
USE HILTI 'HVU' 3/4-6 5/8 ADHESIVE CAPSULES
AND HILTI 'HAS' SUPER RODS 3/4-9 5/8
FOR MORE INFORMATION CALL
HILTI CUSTOMER SERVICE
1-800-879-8000

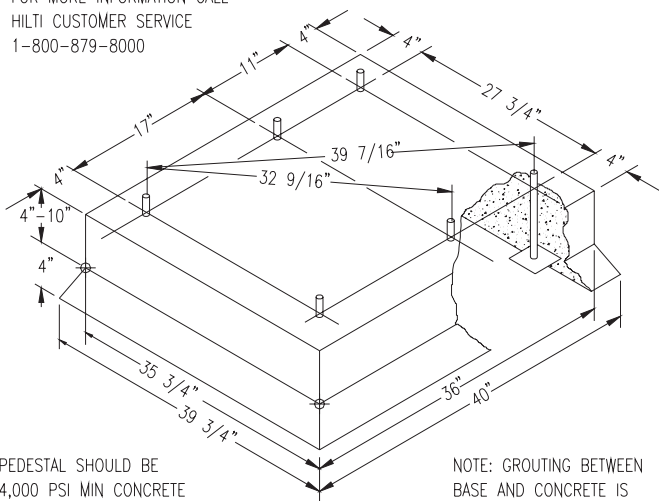

CONCRETE PEDESTAL MOUNTING

Figure 1-1

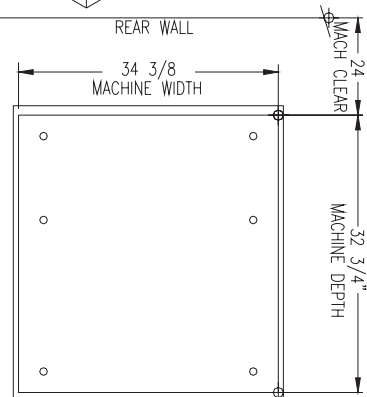
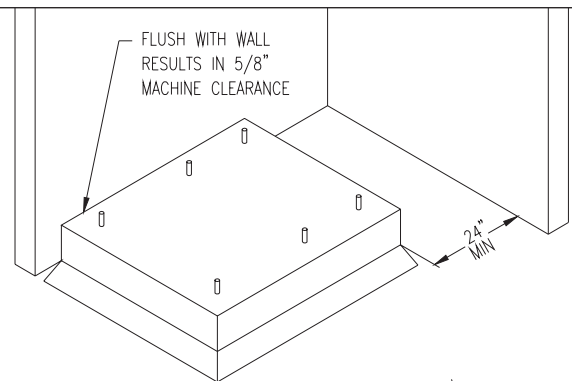

FLOOR OUTLINE

Figure 1-2

T-950 Mounting Dimensions

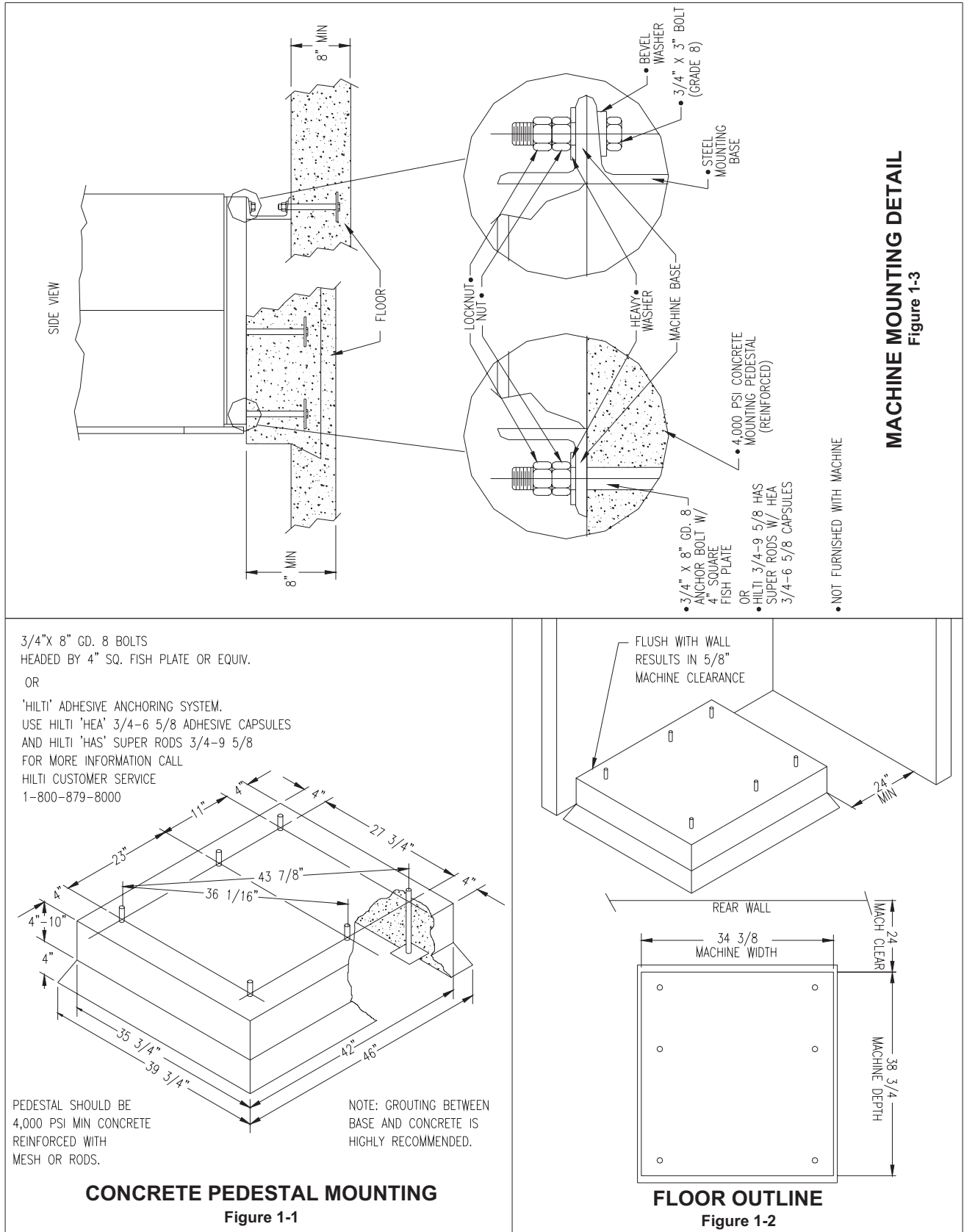

T-1450 Mounting Pad Dimensions

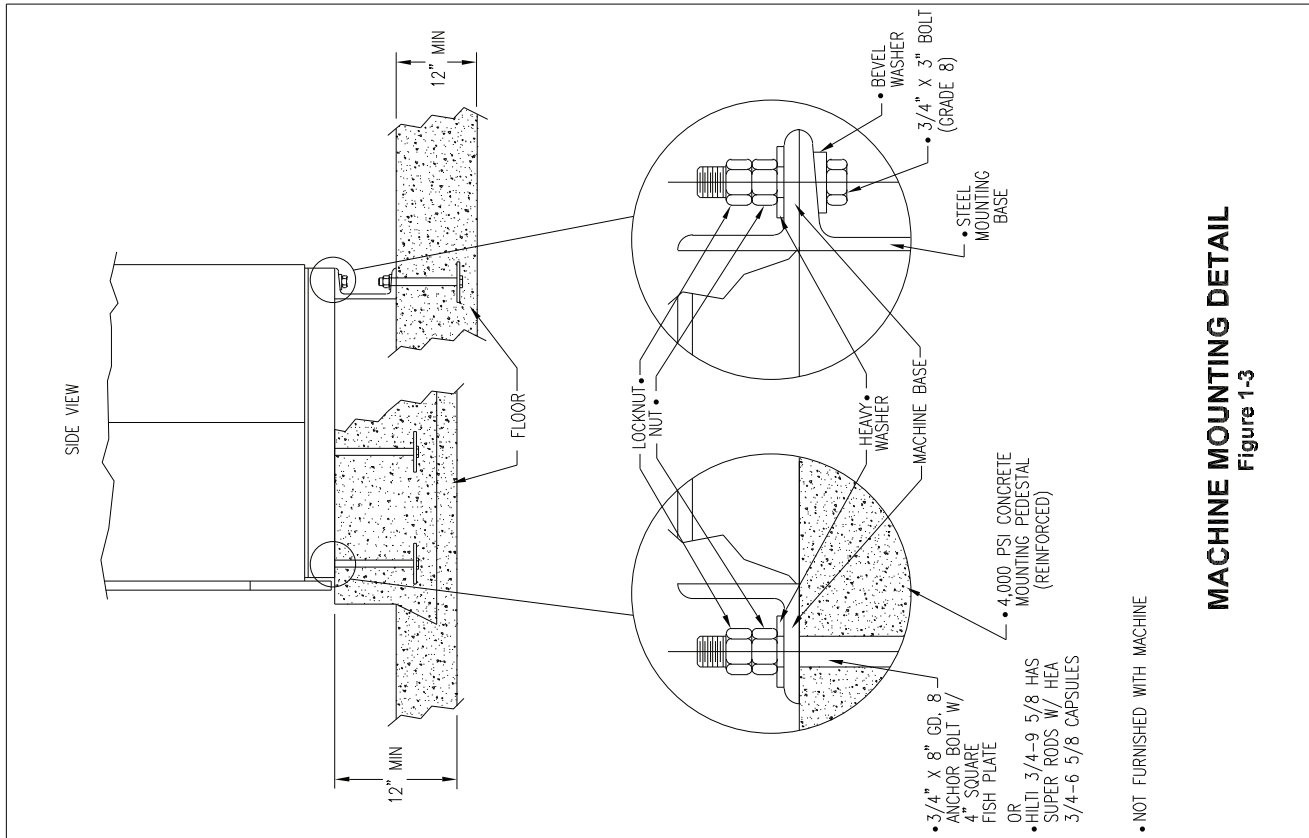

3/4" X 8" GD. 8 BOLTS
HEADED BY 4" SQ. FISH PLATE OR EQUIV.

OR

'HILTI' ADHESIVE ANCHORING SYSTEM.
USE HILTI 'HEA' 3/4-6 5/8 ADHESIVE CAPSULES
AND HILTI 'HAS' SUPER RODS 3/4-9 5/8
FOR MORE INFORMATION CALL
HILTI CUSTOMER SERVICE
1-800-879-8000

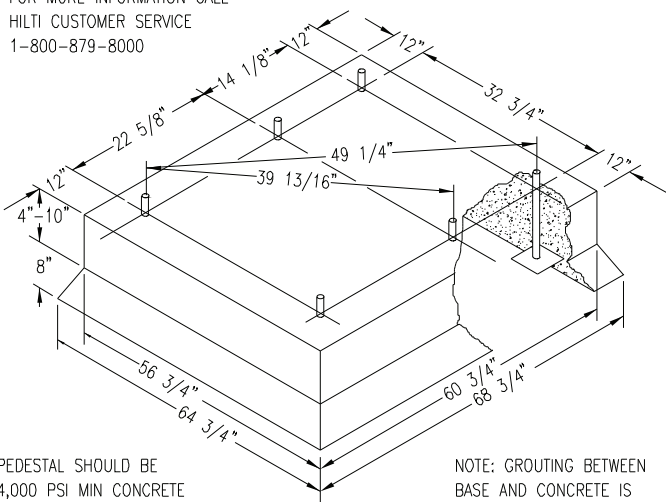

PEDESTAL SHOULD BE
4,000 PSI MIN CONCRETE
REINFORCED WITH
MESH OR RODS.

NOTE: GROUTING BETWEEN
BASE AND CONCRETE IS
HIGHLY RECOMMENDED.

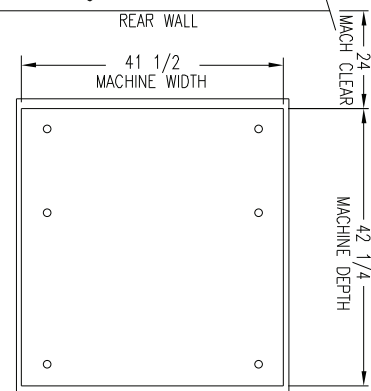
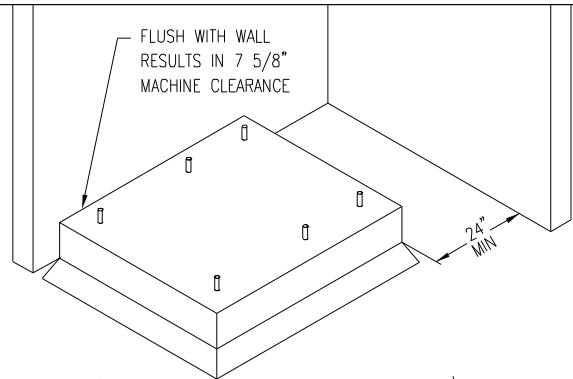

Section 2:

Machine Installation & Operating Instructions

Installation & Operation

All washers must be installed in accordance with all local, state and national building, electrical, and plumbing codes in effect in the area.

Foundation Requirements

The washer must be securely bolted to a substantial concrete floor, or mounted upon a suitable base which is in turn securely bolted to a substantial concrete floor. Care must be stressed with all foundation work to insure a stable unit, eliminating vibration. All installations must be made on sound concrete floors. See mounting dimensions for each model being installed.

Mounting

A concrete pad or steel base which elevates the machine 4 to 6 inches above the floor level. To provide easy access to the loading door, it is recommended to allow a minimum of 24" of clearance behind the rear of the machine for service as is shown. Dexter highly recommends the use of a dry expansion grout mix.

Proper Machine Grout Installation

Grout should be installed between base (if used) and concrete floor on all side rails and crossmembers. If using a base you should grout between base top and machine frame and all side rails and crossmembers. (Grouting between the machine base and the floor is absolutely required for all 200G Express Models)

Mounting Holes

See mounting dimensions for the machine model you are installing in previous section. They also show a typical concrete pad arrangement. It is highly recommended that you use all mounting holes supplied with each model. Note: Mounting bolts should be checked frequently to insure that they remain tight. The machine should be checked with a spinning load to be sure there is no unusual vibration or movement between the machine and the base or floor. Please note: Machine grouting is highly recommended as grouting insures stability and longevity.

Plumbing

Water supply hoses are furnished with each machine. The threaded connections on the hoses are standard garden hose type thread. Separate hot and cold water lines with shut off valves or faucets for inlet hose connections must be provided, maintaining 30 to 120 p.s.i. water flow pressure. Maximum water temperature is 180 degrees.

Drain

The drain outlet tube at the rear of the machine is 3" in outside diameter on models T-400, T450, & T-600. The drain outlet tube at the rear of the machine is 2 1/4" outside diameter on a T-300 and T350 models. All Drains are gravity Drain. Adequate fall must be maintained for proper drainage.

Protective Film

The machine may have protective adhesive film on the front escutcheon area and the front and side stainless steel panels. The film may be peeled off before putting the machine into service.

Electrical

Dexter single/three-phase 208-240VAC 60 Hz washing machines are intended to be permanently installed appliances. No power cord is provided. The machine should be connected to an individual branch circuit not shared by lighting or other equipment. The connection should be sheathed in liquid tight flexible conduit, or equivalent, with conductors of the proper size and insulation. A qualified technician should make such connections in accordance with the wiring diagram.

T-300 WCAD20KCS-10 model (1 phase 120 volts) washers are equipped with an electrical cord with a 3 prong grounded plug. A U.L. approved receptacle, which has been properly grounded in accordance with local electrical codes must be used with the machine. Each unit should be connected to an individual branch circuit not shared by lighting or other equipment. Conductors of the proper size and insulation (suggested size below) should be used.

To Make Electrical Connections

Disconnect all power to the washer. Remove screw and lift out the cover located in the upper left corner of the machine (as viewed from the back).

- If power is 208-240-3PH-60Hz, connect L1, L2, L3 and ground. If there is a high leg it must be connected to L3. It is highly recommended to use a TVSS.
- If power is 208-240-1PH-60Hz, connect L1, L2 and Ground. If power is 120 -1PH-60Hz. Use a UL approved receptacle with proper external ground.

NOTE: It is important that the grounding screw next to the power terminal block TB-1 be connected to a good external ground.

Controls Transformer

The controls transformer is located inside the control trough and steps a range of 208 to 240 volts down to 115 volts. There are two terminals on the controls transformer for the primary (incoming) power. Use the terminal marked "208V" for power supplies between 200 and 215 volts. Use the terminal marked "230V" for power supplies between 216 and 240 volts.

NOTE: transformer must be set at proper tap for proper operation.

Electrical Connections

Electrical power connections are made to the small terminal block located in the rear of the control trough. The terminal block is accessed by opening the top panel of the machine.

- 1 Phase or 3 Phase connections
- 208-240 volts, 60 Hz.
- 3 wire plus ground
- Suggested Minimum Wire Size -- 12 Ga.

Fusing Requirements:

Dual element time delay fuse or equivalent breaker of amperage specified below.

- 1 Phase or 3 Phase 20 amp
- WCAD50SZ, WCAD-60, WCAD60SZ, WCAD-80, WCAD90SZ

Rotation in extract as viewed through glass door at front of washer models WCAD-50sz,WCAD-60,WCAD-60sz,WCAD-80,WCAD90sz will be counter- clockwise.

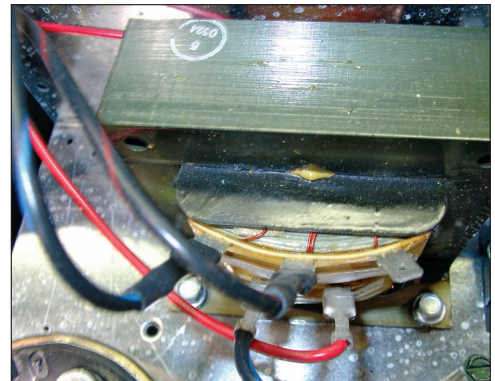
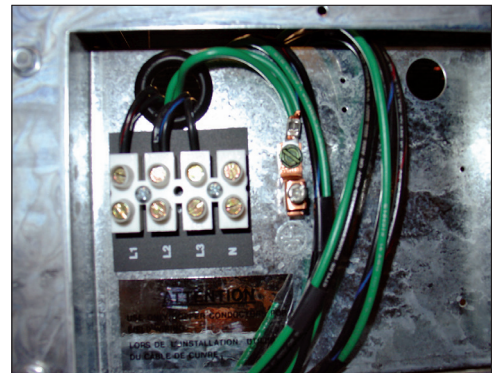

WARNING

Always disconnect electrical power to the machine before performing any adjustments or service.

Emergency Stop / Safety Door Lock

This machine is equipped with a Safety Door Lock that locks the door closed from when the cycle is started until the cycle is complete. The door lock prevents opening the door for up to 3 minutes if the power is interrupted during the cycle.

The Emergency Stop button pauses the washer and allows the door to be opened during the cycle after the Safety Door Lock releases. When the Emergency Stop button is pressed an alarm will sound and the display will begin counting down from "3". If the button is released before 3 seconds elapse, the alarm will stop and the cycle will continue normally. If the Emergency Stop is held down for 3 seconds, the display will count down to "0" and the washer will begin stopping movement and water flow and begin draining water from inside the washer. Though the machine may stop wash movement quickly, it may take up to 3 minutes for the door to unlock. During that time the alarm will continue to sound. When the alarm stops, the door may be opened. The washer may be restarted by closing and latching the door, and pressing the Start button. If the washer was stopped during final extract, the cycle will be ended. If the washer is stopped for more than 1 hour, the cycle will be terminated. If the emergency stop is triggered a second time during the cycle, the cycle will be terminated.



Operating Instructions

Microprocessor

Prior to operation, the micro computer should be set to display the amount of vend price being offered and the cycle to be given to the user. NOTE: Should a power loss occur during cycle and when power returns, P U S H will be displayed in window and customer must push the START button to continue the cycle.

Starting the Washer

- A. Load the clothes loosely in the cylinder and latch the door securely. Be sure clothing does not get caught between the door gasket and tub front when closing the door.
- B. Pour low-sudsing powdered detergent in the amount shown below into the detergent dispenser on top of the machine. Rinse conditioners may also be added to the dispenser. The correct location is shown on the dispenser lid.

NOTE: To close the door the handle must be in the horizontal position and then moved to the vertical position . After moving the door to the closed position, the handle must be turned down to the vertical position to latch the door for machine operation.

- C Using the TEMPERATURE SELECT buttons on the front, select the desired temperature. If temperature pricing is being used you will display price changes as you push the desired temperature selection.
This selection must be made before inserting coins to satisfy temperature price selected.If coins or value are added after extended plus cycle vend price is met it will be lost without credit. If water temperature pricing feature is active and vend price met and machine started the customer may change temperature selections of equal to or lower priced temperature selections already inserted into machine.

- D. Insert coins, tokens or activate card reader to meet displayed vending price. The washer will start, the display will read PUSH and the green "on" led will glow. The green start pushbutton must be pushed to start cycle time countdown and machine starting to run. "Door" will display if loading door is not closed and handle locked.
- E. If utilizing ADD PLUS CYCLE \$.000 option The front display will scroll, ADD PLUS CYCLE .25(example),amount to be added. User will have 1 minute to insert proper amount to activate this option.
- F. At the correct time in the wash bath cycle the green "ADD BLEACH" light will come on indicating the time and showing a diagram of the location for adding bleach if desired. The timing is 2 1/2 minutes after start of wash bath the light will come on and stay on for 2 1/2 minutes or end of wash bath .

End of Cycle

When the cycle is completed, the end of cycle buzzer will sound and the "on" light will go off. The loading door can now be opened by turning the door handle to the indicated position and pulling. Leave the clothes door open when the machine is not in use. Also, at the end of cycle the display will reset to the original amount required to start.

**Detergent Measurements
By Washer Model**

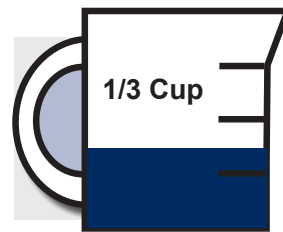

T-650 Washer

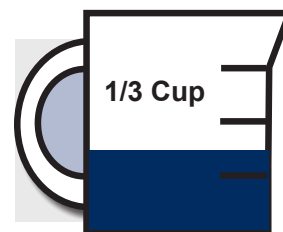

T-750 Washer

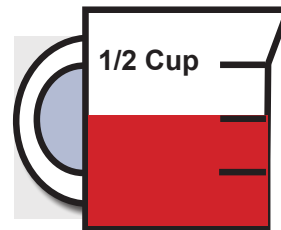

T-950 Washer

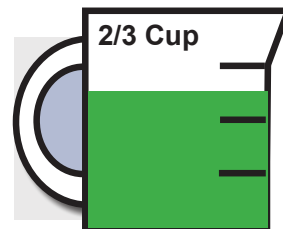

T-1450 Washer

TRANSIENT VOLTAGE SURGE SUPPRESSORS

Like most electrical equipment your new machine can be damaged or have its life shortened by voltage surges due to lightning strikes which are not covered by factory warranty. Local power distribution problems also can be detrimental to the life of electrical components. We recommend the installation of transient voltage surge suppressors for your new equipment. These devices may be placed at the power supply panel for the complete installation and don't require an individual device for each machine.

These surge protectors help to protect equipment from large spikes and also from small ongoing spikes in the power that occur on a day to day basis. These smaller surges can shorten overall life of electrical components of all types and cause their failure at a later date. Although they can't protect against all events, these protective devices have a good reputation for significantly lengthening the useful life of electronic components.

Electronic Components are helped to have a longer useful life when they are supplied with the clean stable electrical power they like.

We are including the following names and links to a few suppliers of these devices for those who don't currently have a source.

MANUFACTURER	LINK
MCG Surge Protection	mcgsurge.com
Eaton Corporation	eaton.com/us/en-us
Schneider Electric	se.com/us/en
Asco Power Technologies	ascopower.com/us/en
Emerson Electric Co.	emerson.com/en-us

Notes

Lined area for taking notes.

Section 3:

Machine
Programming
Instructions

DexterLive

The new DexterLive controls were created for you to be able to interface easier with your equipment and create variable pricing cycles to increase your profitability in the same floor space.

First, log into DexterLive, create your location and equipment list and then create your cycle and pricing information by the particular type of washer and dryer at the location. Once the information is saved, download the "AllUser.xml" file to a USB device which will be used to program the machines from the USB port.

Keep it simple or use the marketing features such as temperature pricing, plus cycle or an additional final rinse that the customer can select for a value added wash. Utilize time of day pricing to help move people from heavy use periods to special value times of day or days of the week.

Through the easy to use USB programming so you can download all special pricing and cycles from DexterLive to set up your store quickly and easily.



Accessible

Available anytime, anywhere, on any internet capable device. Once you have set up your free account all of your custom settings and store information are saved making it quick and easy to make future changes.

Simple

View and customize equipment settings to fit your business model. Download your unique user file and quickly transfer it to your equipment via USB.

Profitable

Create exciting promotions to attract new customers. Offer extra prewash, plus cycles, Extra rinse and temperature pricing to drive more revenue in your store.

First Time Creating an Account at Dexter Live

- 1) Log into DexterLive
At the bottom, select "Create your DexterLive account."

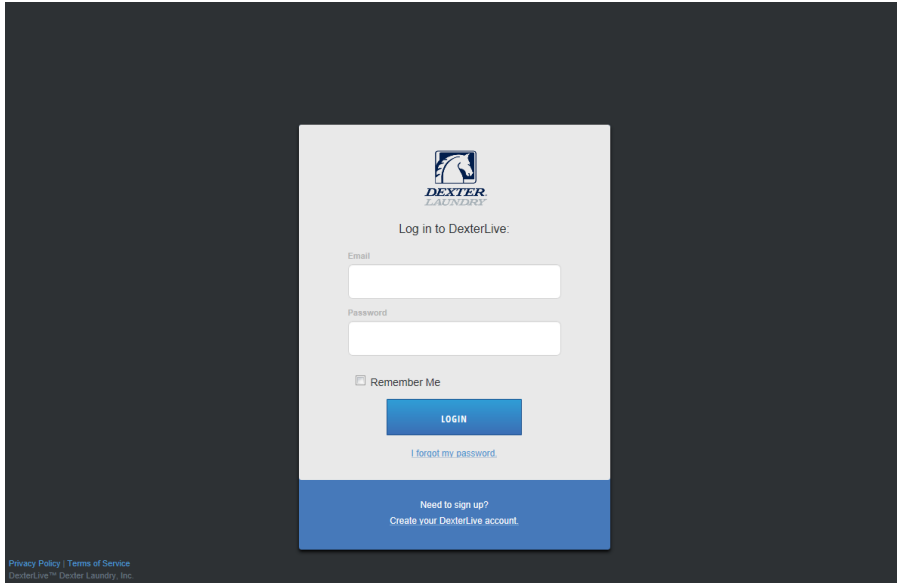

The screenshot shows the DexterLive login interface. At the top is the Dexter Laundry logo. Below it, the text "Log in to DexterLive:" is displayed. There are two input fields for "Email" and "Password". A "Remember Me" checkbox is located below the password field. A blue "LOGIN" button is centered below the fields. Below the button is a link that says "I forgot my password." At the bottom of the form, there is a blue bar with the text "Need to sign up? Create your DexterLive account." In the bottom left corner, there is a small link for "Privacy Policy | Terms of Service".

DexterLive gives an owner the ability to manage multiple locations.

- 2) At the "Create a DexterLive Account" screen.
 - A. First time users must create an account.

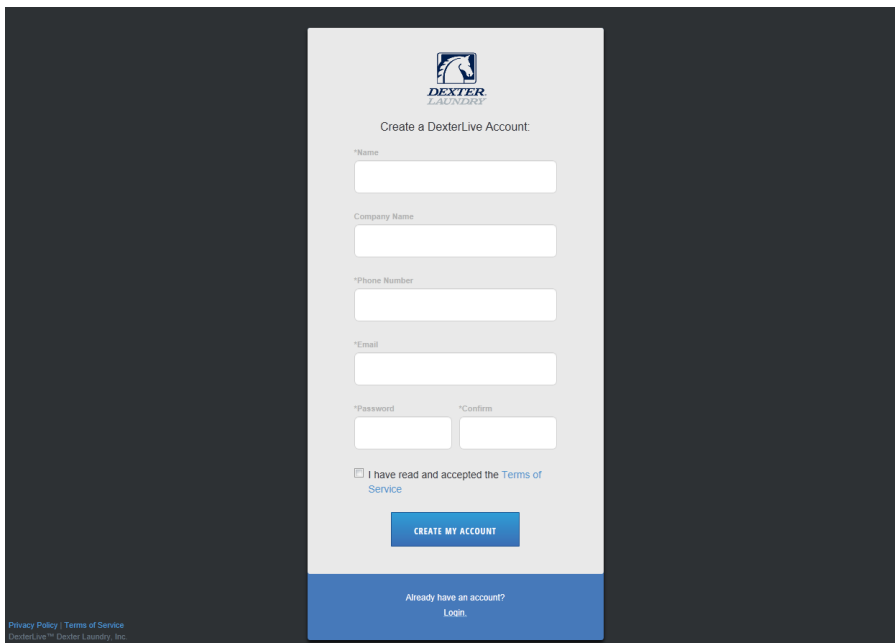

The screenshot shows the "Create a DexterLive Account" form. It features the Dexter Laundry logo at the top. The title "Create a DexterLive Account" is centered. The form includes several required fields: "Name", "Company Name", "Phone Number", "Email", "Password", and "Confirm". There is a checkbox for "I have read and accepted the Terms of Service". A blue "CREATE MY ACCOUNT" button is positioned below the fields. At the bottom, there is a blue bar with the text "Already have an account? Login." In the bottom left corner, there is a small link for "Privacy Policy | Terms of Service".

An account must be created to use the DexterLive features.

- B.** Fill in the required fields and click on "Create My Account".

The screenshot shows the "Create a DexterLive Account" form. At the top is the Dexter Laundry logo. Below it, the form fields are: "Name" (with an asterisk) containing "Your Name", "Company Name" containing "ABC Laundry", "Phone Number" (with an asterisk) containing "###-###-####", "Email" (with an asterisk) containing "YourEmail@ServiceProvider.com", "Password" (with an asterisk) and "Confirm" (with an asterisk) fields both containing "*****". There is a checkbox for "I have read and accepted the Terms of Service" which is checked. A blue "CREATE MY ACCOUNT" button is at the bottom. In the bottom left corner, there is a link for "Privacy Policy | Terms of Service" and the text "DexterLive™ Dexter Laundry, Inc."

When creating a new user account make sure to fill in all fields marked with asterisks and check the "Terms of Service" box.

- C.** After selecting to "Create My Account", you will see the log in screen advising you to go to your e-mail and activate your account.

The screenshot shows the "Log in to DexterLive:" screen. It features the Dexter Laundry logo, an "Email" field, a "Password" field, and a "Remember Me" checkbox. A blue "LOGIN" button is present, along with a link for "I forgot my password." At the bottom, there is a blue bar with the text "Need to sign up? Create your DexterLive account." A green callout box on the right side of the form contains the text: "A message with a confirmation link has been sent to your email address. Please open the link to activate your account." In the bottom left corner, there is a link for "Privacy Policy | Terms of Service" and the text "DexterLive™ Dexter Laundry, Inc."

After creating your account you will need to use the e-mail link to gain first access. The account will not be active until you confirm your account.

- 3) Open the e-mail sent from Dexterlive and select "CONFIRM MY ACCOUNT"

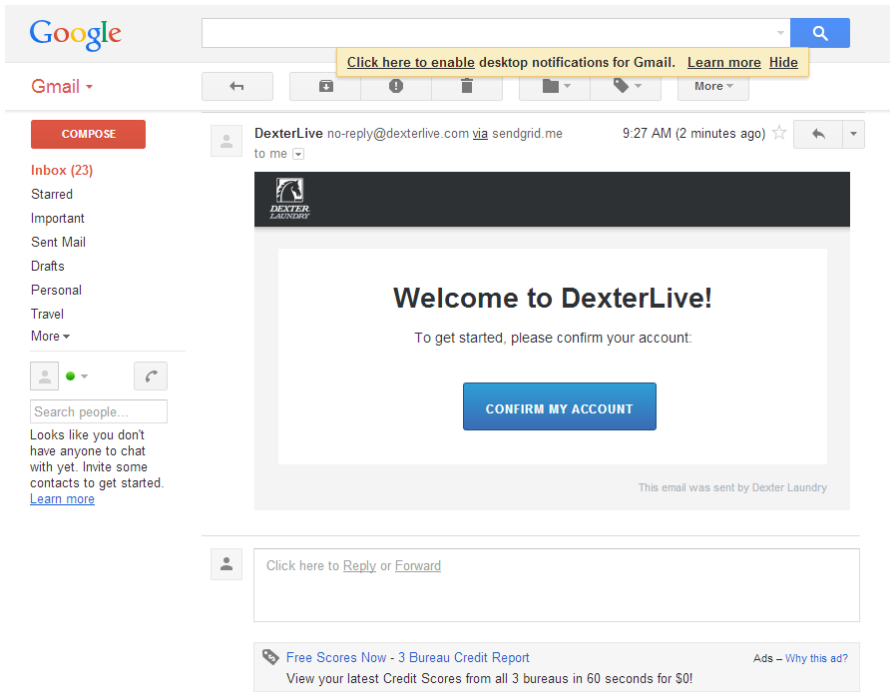

Selecting the "Confirm My Account" hyperlink will take you back to the DexterLive log in page.

- 4) At the "Log into DexterLive" screen, enter your e-mail/user name and password to access DexterLive.

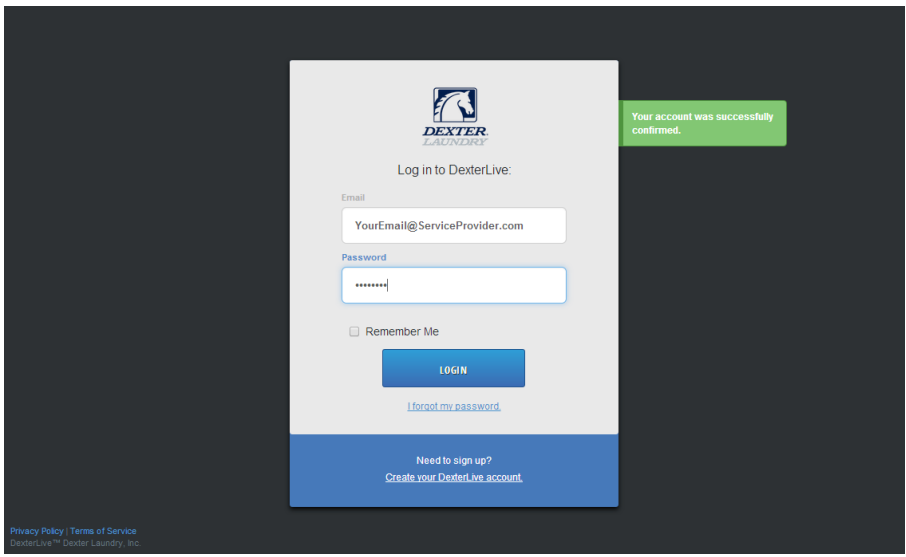

Welcome to DexterLive. Proceed to the step to create your location information.

Programming

- 5) To configure your settings with DexterLive.com:
 - A. Add or select a location to program.

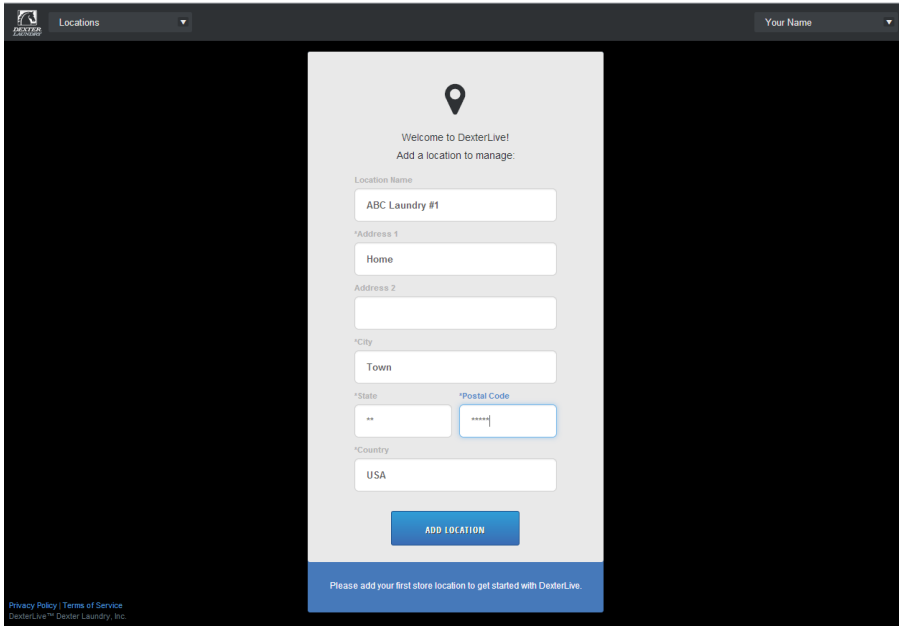

DexterLive gives an owner the ability to manage multiple locations and machines.

- B. On the left side of the screen, select the "Programming" tab.

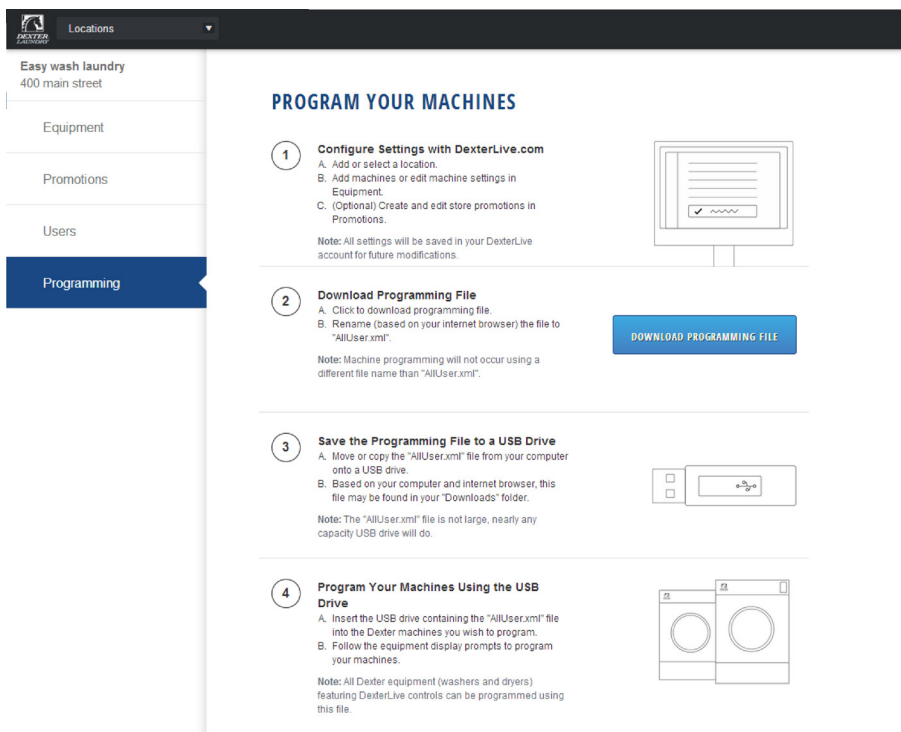

Follow instructions in the programming tab.

C. Edit the "General Settings" (Equipment Tab)

Locations

Easy wash laundry
400 main street

Equipment

Promotions

Users

Programming

General Settings - All Machine Types

Washers and Dryers

Machine Display Language: English

Display Decimal Point: On

Sounds: On

Password: 0000

Time Shift: +0 hours : 0 minutes

Washers Only

Drive Table: Current

Dryers Only

Display Temperature Scale: °F

Display Time: Minutes only displayed

Central Pay: Off

Cancel Save

Adjust setting and offset time to match your location.
(Time is set for Central Standard Time)

D. Next select the "+Add Equipment" (Equipment Tab), located in the upper right hand corner.

Locations

Easy wash laundry
400 main street

Equipment

Promotions

Users

Programming

EQUIPMENT

General Settings + Add Equipment

T-350 Express Washer
6 units at this location

Add Machine

My Machine Name: D1

Serial Number: D2.14076.006

Machine Type: T-30X2 Stack Dryer

DexterLive ID:

SAVE & CONTINUE

Done adding machines

Name of the machine.
(Example: Dryer 1)
Enter serial number and machine type then select "Save and Continue."

- E.** When all of the equipment has been added, select "Edit" on the machine type you wish to modify, and then select "Pricing". (Equipment Tab and Machine Settings Tab)

T-350 EXPRESS WASHER

Pricing Cycles

Category	Field Name	Value
Pricing	Base Vend Price	3.50
Adders	Warm Temp Adder	0.25
	Hot Temp Adder	0.50
	Pre-Wash Adder	FREE
	Extend Wash Adder	0.25
	Extra Rinse Adder	FREE
Promotional Pricing	Base Vend Price (B)	3.00
	Base Vend Price (C)	3.50
Coin Values	Left Coin Value	0.25
	Right Coin Value	1.00

Cancel Save for all T-350s

Program the price of the machine and the extra pricing adders.

- F.** Cycle changes can be made by selecting the "Cycles" tab.

T-350 EXPRESS WASHER

Pricing Cycles

Cycle	Time	Temp	Spin
Pre-Wash	Off	Cold	Off
Wash	9 min	Warm	Off
Extended Wash	1 min		
Rinse	4 min	Cold	1 min
Final Rinse	5 min	Cold	6 min
Extra Rinse	Off	Cold	Off
Extract Speed	Final Spin Speed	200G	
Options	Delay Fill	Off	
	Delay Spin	Off	

Cancel Save for all T-350s

Adjust cycle programming set the length of time and extracts speed as needed.

- G.** IF desired, you may create and edit optional store promotions from the "Promotions" Tab.

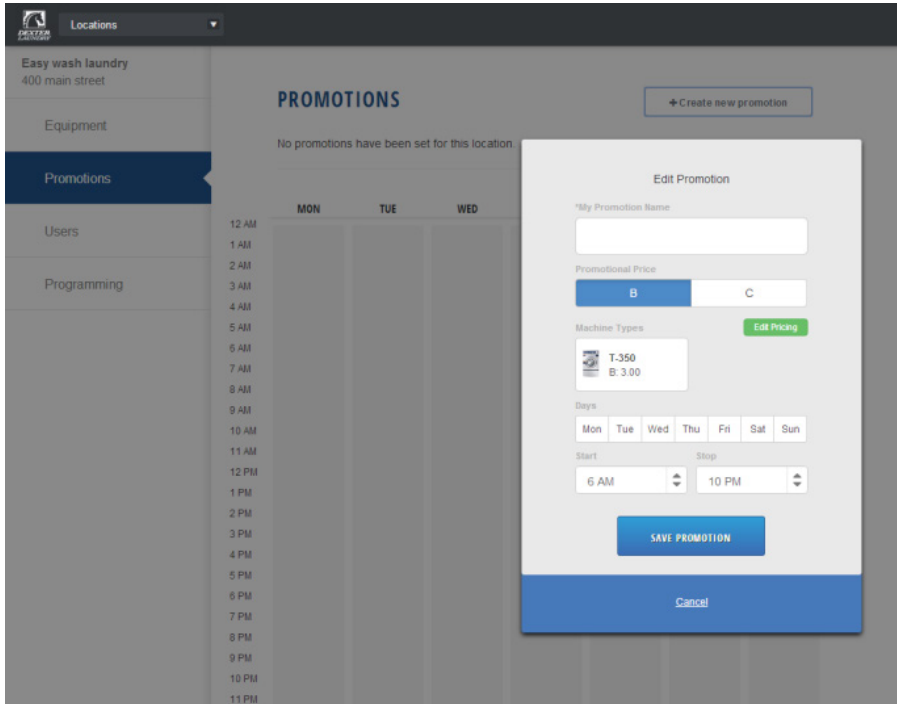

Select "Save Promotion" once your changes have been made.

- 6)** Create and download the Programming File.
- A.** Once all preferred prices, cycles and promotions have been modified and saved, select **"DOWNLOAD PROGRAMMING FILE"**.

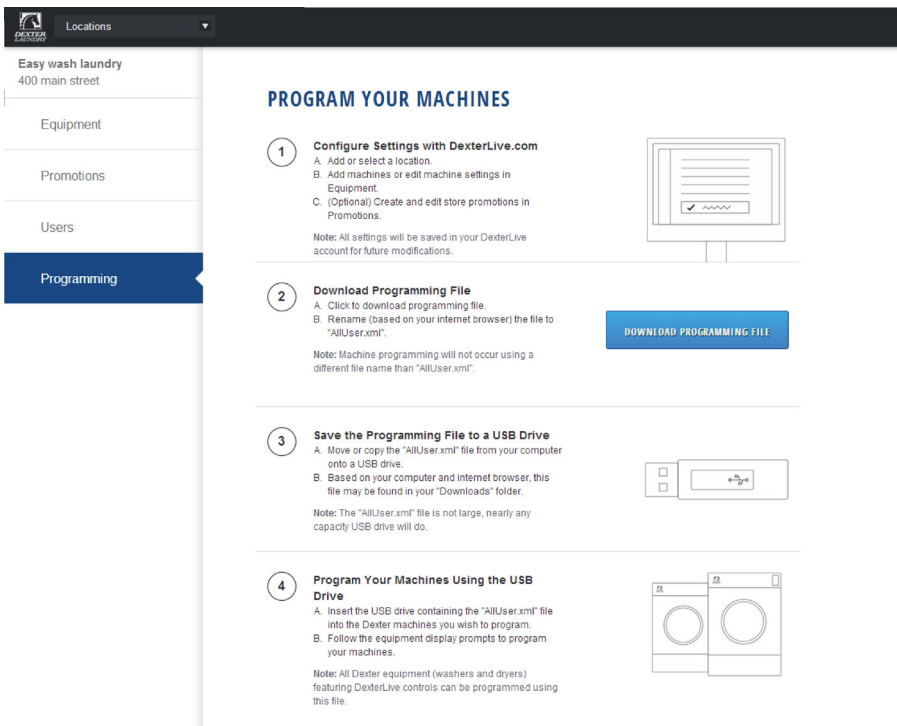

-
- B.** Based on your internet browser the file needs to be saved as "AllUser.xml". Depending on your Internet browser you may need to retrieve the file from your "Downloads" folder, which is located under "Computer"..

Note: The newly created programing file may have changed from the proper "AllUser.xml. Machine programming will not occur using a different file name than "AllUser.xml". Any extra extension names will require the file to be renamed back to "AllUser.xml" for the machine to recognize the file.

7) To save the Programming File to a USB Drive:

- A.** Move or Copy the "AllUser.xml" file from your computer onto a USB drive.
- B.** Based on your computer and internet browser, this file may be found in your "Down loads" folder, which is located under the "COMputer" area.

Note: The "AllUser.xml" file size is small, nearly any capacity USB drive will do.

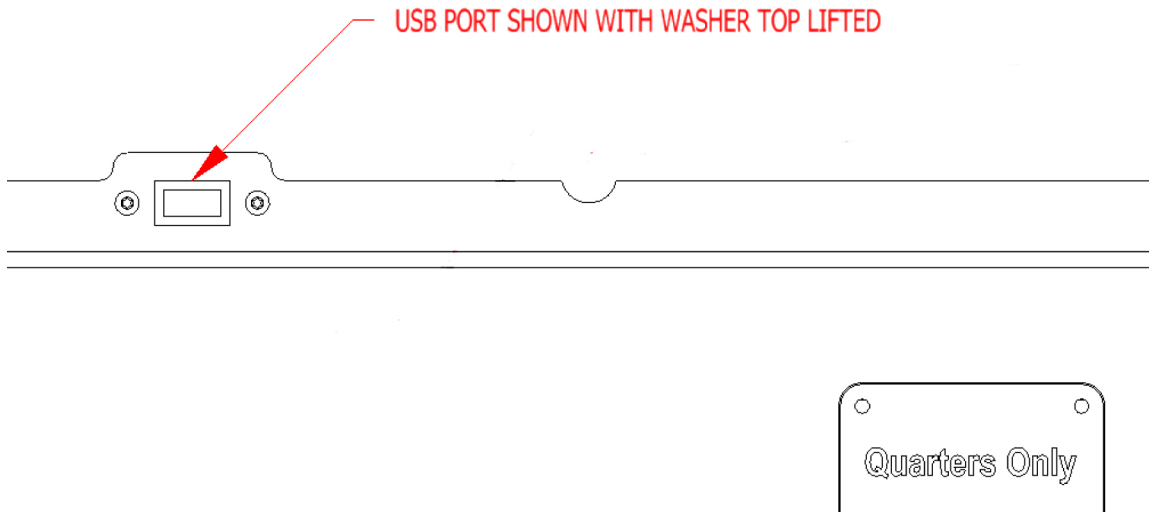

8) Program Your Machines Using the USB Drive

CAUTION!!! Be sure that any loose keys or other items that are connected to the USB device are removed from the USB stick to prevent any possible metal contact with the control board.

- A.** Insert the USB drive containing the "AllUser.xml" file into the Dexter machines you wish to program. The control will scroll "....." while identifying the program on the USB. Once identified, the display will scroll "INSTALL USER FILE FROM USB". At this prompt press the green start button on the front panel.

- B.** The machine will scroll "TO INSTALL – PRESS START". At this prompt, press the green "Start" again.



- C.** Once the program is uploaded successfully the control will scroll "DONE REMOVE USB". The USB drive can be safely removed at this point.

Note: All Dexter equipment (washers and dryers) featuring DexterLive controls can be programmed using this file once the equipment has been configured.

PROGRAMMING INSTRUCTIONS:

The washer control can be programmed to prompt the user for alternate vend prices, change washer cycle times, temperatures and many other options. This can be accomplished in two ways:

1. Manual programming utilizing the "Start", "Hot", "Warm" and "Cold" buttons
2. USB download

For instructions on using the USB download feature, please contact your local Dexter distributor.

MANUAL PROGRAMMING:

The washer must be in idle mode for the manual programming menus to be accessed. Idle mode is when the washer is not actively running a wash cycle and the vend price is displayed on the screen.

To enter the manual programming mode, the top of the washer must be unlocked and lifted slightly (it should not be necessary to remove the screws for the soap box). The programming button is then pressed for 1 second. The control should display "PROGRAMMING".

See Figure 1 for the location of the programming button in relation to the USB port (The USB port is exposed when the washer top is lifted).

Figure 1

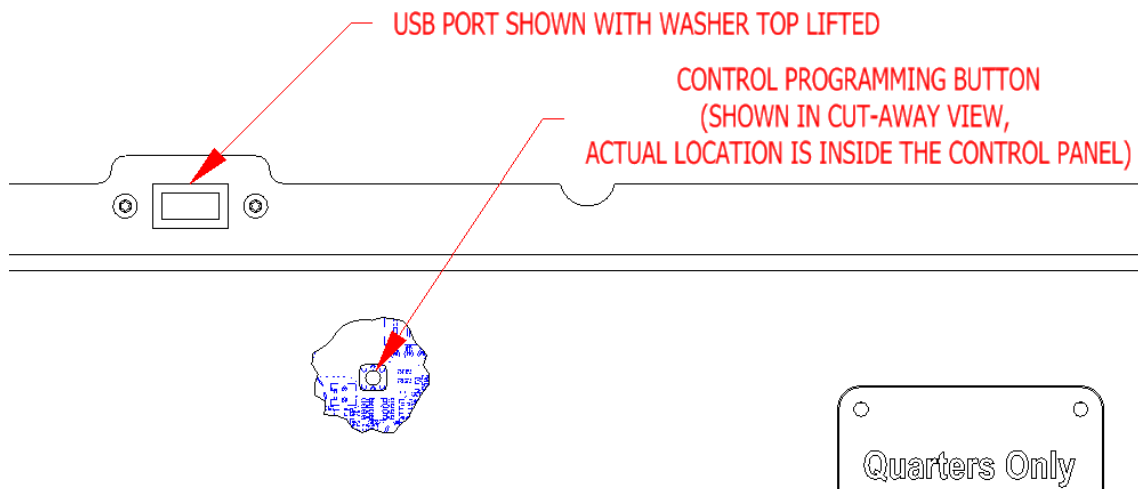

When manual programming mode is entered, the "Start", "Hot", "Warm" and "Cold" buttons perform alternate functions.

Button Name	Alternate Function in Programming Mode
Start	Becomes the action to accept the displayed option or the "Enter" key
Hot	Becomes the action to move UP through displayed options (Press & hold for accelerated scrolling)
Warm	Becomes the action to move DOWN through displayed options (Press & hold for accelerated scrolling)
Cold	Becomes the action to move back a step (1 press) or EXIT from programming mode (press for 3 seconds)

Programing Selection:

These alternate functions allow the user to move through a menu of options to choose various program-able settings. Figure 2, shown below, shows the top level menu. Choosing an option from the top level menu will then display the next level of options (the sub menu).

Figure 2

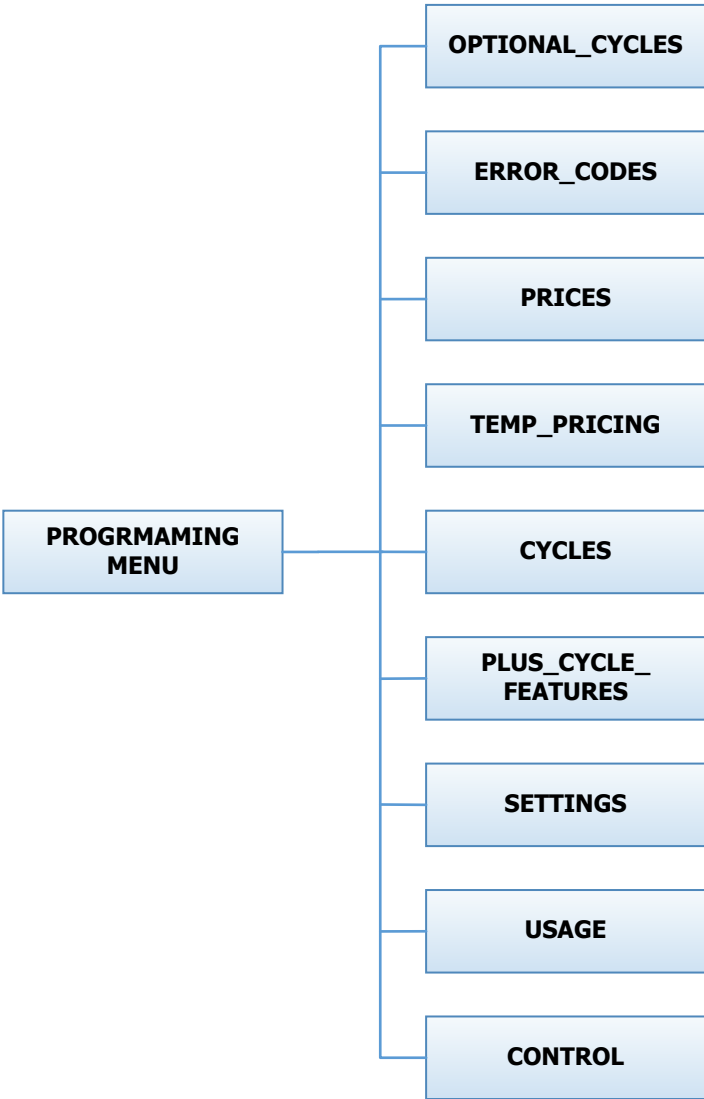

Optional Cycles Option:

This option allows the user to select the different test and short-cycle options.

Figure 3

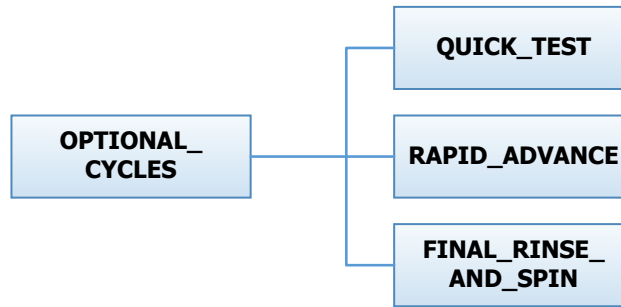

Quick Test Option:

When the Quick Test Option is chosen, the washer will begin a shortened wash cycle without the displayed vend price being met. The purpose of this shortened cycle is to test all major components for proper operation.

Error Codes should all function normally during this test. The display will show customer prompts in a similar way to a normal wash cycle. Exceptions to this are that the "ADD BLEACH" prompt will not occur because of reduced cycle time. Final Extract speed is specific to the customer's programming.

Bath	Bath Cycle Time (min.)	Water Temp	Delay Fill	Spin Time (min.)
Prewash	0	n/a	n/a	0
Wash	1	Hot	On	2
Extended Wash	0	n/a	n/a	n/a
Rinse	1	Cold	On	0
Final Rinse	0	Cold	On	n/a
	n/a	n/a	n/a	0
Extra Rinse Bath	0	n/a	n/a	n/a
Final Extract Spin	n/a	n/a	n/a	4

Rapid Advance Option:

Similar to the Quick Test, when the Rapid Advance Option is chosen, the washer will begin a wash cycle without the displayed vend price being met. However, in this case, it will be a normal default cycle with an additional feature available. The "START" button LED will flash, prompting the user that, when pressed, the washer shall rapid advance to the next step in the cycle. The display will show "ADVANCE" when the cycle is advancing. The water level needs to be empty before this advance occurs. During the time waiting for the tub to empty, the "ADVANCE" prompt will be held on the display and the START pushbutton LED stops flashing. The Rapid Advance shall allow the tub to empty of water and the tub to stop before beginning either spin or the next bath.

The Rapid Advance mode can be exited by pressing the programming button. This will end the cycle.

When the Rapid Advance mode is used, the cycle time will no longer be correct. By skipping steps with Rapid Advance, the door may not open immediately at the end of the cycle.

Final Rinse and Spin Option:

“Final Rinse and Spin” will begin only the Final Rinse Bath and Final Spin portions of the cycle without the displayed vend price being met. The configured temperature, cycle times, and spin speed for the Final Rinse Bath and Final Spin settings will be used when this option is selected.

NOTE: Error Codes should all function normally during this test.

Error Code Historical Log:

The last five occurring error codes will be stored in the control with a time and date stamp. The purpose of this option is only to observe the history of these code occurrences (no changes can be made).

The time is based off the Real Time Clock, but potentially shifted by the user’s manual programming changes (Shift Hours option) and/or network time override. As additional error codes occur, the oldest of the five logged codes is cleared from memory.

Figure 4

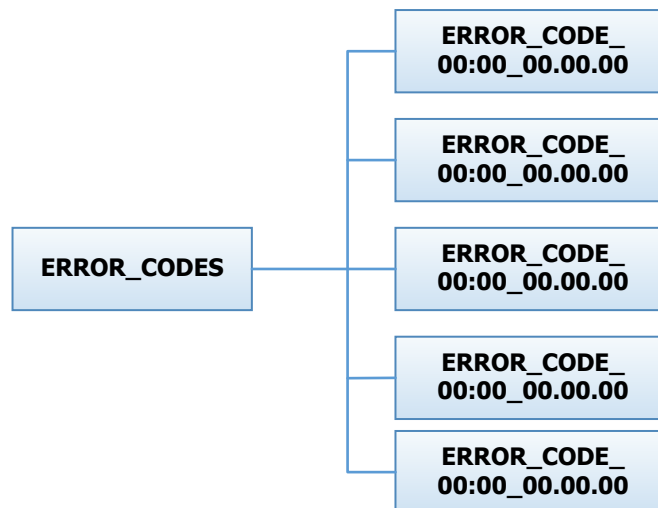

Prices Option:

This option allows the user to set values for coin acceptor inputs and to set the vend price. It also allows the user to return the values to factory defaults. "RIGHT COIN" and "LEFT COIN" are the two possible inputs from coin acceptors.

"SET VEND" is the actual Base Vend Price (or Vend Price A) that is shown on the control display. After changing prices using the "Up" or "Down" buttons, the "Enter" button must be pressed again for the control to store the changes that have been made.

To reset either the coin acceptor inputs or the vend price to factory default, press "Enter" when the "DEFAULT" prompt is shown. Press "Enter" again when the "RESET" prompt is shown to confirm the action.

Figure 3, shown below, shows the sub menu options for Prices:

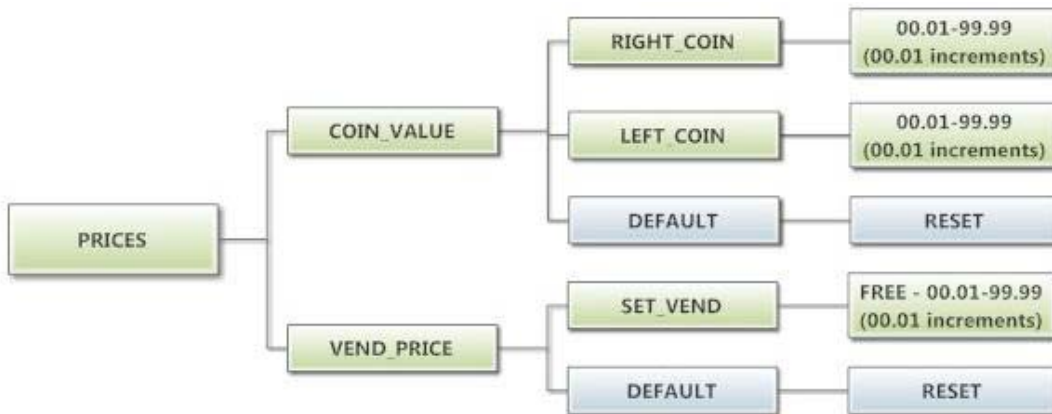

Temp Pricing Option:

The Temperature Pricing option allows for the user to prompt the customer for varying vend prices based on the water temperature the customer selects. If a value other than 0 is programmed for either the "WARM ADDER" or "HOT ADDER", the feature becomes active. The programmed value is added to the base vend price when that particular water temperature is chosen.

When the customer adds coins to meet the adjusted vend price and starts the washer, the temperature selections available to the customer are limited to those with vend prices equal to or less than the amount entered.

Figure 4, shown below, shows the sub menu options for Temp Pricing:



Cycles Option:

This option allows the user to set the bath time and spin time for the "Wash" bath. It also allows the user to set bath time, water temperature and spin time for "Rinse" and "Final rinse" baths. (Water temperature for the "Wash" bath is chosen by the customer using the "Hot", "Warm" and "Cold" buttons on the front of the machine). For the "Final Spin" it also allows the user to set the spin speed (see additional description below).

It also allows the user to return the values to factory defaults. To reset all values in the Cycles option to factory default, press "Enter" when the "DEFAULT" prompt is shown. Press "Enter" again when the "RESET" prompt is shown to confirm the action.

Figure 5, shown below, shows the sub menu options for Cycles:

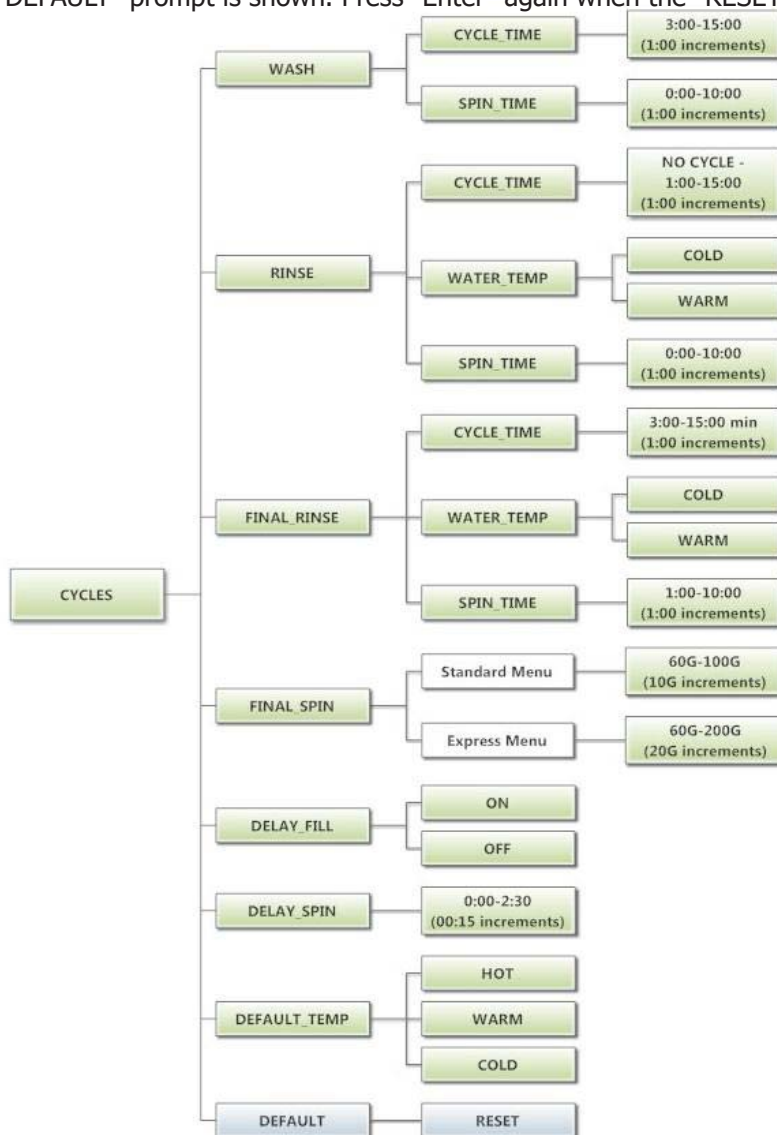

Bath	Bath Cycle Time (min.)	Water Temp	Delay Fill	Spin Time (min.)
Prewash	0	Cold	Off	0
Wash	9	Warm	Off	0
Extended Wash	0	n/a	n/a	n/a
Rinse	4	Cold	Off	1
Final Rinse	5	Cold	Off	n/a
Extra Rinse Spin	n/a	n/a	n/a	0
Extra Rinse Bath	0	Cold	Off	n/a
Final Extract Spin	n/a	n/a	n/a	6

Final Spin:

The washer "Final Spin" is the spin that occurs after all selected baths & intermediate spins have been completed. It is a higher spin speed than previously occurring intermediate spins. The benefit of this higher spin speed is that more water is extracted from the wash load, which minimizes the drying time needed. However, in some cases, if the Dexter installation guidelines are not followed properly, it may be necessary to reduce the spin speed of the "Final Spin". The control allows for this to occur, based on the menu shown above.

The Final Spin can be adjusted in increments of 10 G for washers with a 100G maximum spin speed and increments of 20 G for washers with a 200G maximum spin speed. The factory default final spin speeds are the maximum values.

Model	Adjustable Final Spin Range
T300	60G to 100G
T350	60G to 200G
T400	60G to 100G
T450 or T450 SWD	60G to 200G
T600	60G to 100G
T750	60G to 200G
T900	60G to 100G
T950	60G to 200G
T1200	60G to 100G
T1450	60G to 200G

Delay Fill:

In some applications, the amount of available water pressure is limited. In these cases, the washer may not be able to fill the tub in sufficient time to allow for effective washing performance. For this situation, the control has a "Delay Fill" option that can be chosen based on the menus above.

When the Delay Fill option is "On", the water valves shall be turned on, the washer shall agitate, but the cycle time shall be paused. The washer shall continue in this state until the proper water level is reached. Once the proper water level is reached, the cycle shall continue. A single selection of "On" or "Off" shall apply to all baths in the cycle. The factory default setting is "Off".

Delay Spin:

In some applications, the amount of drain capacity is limited. In these cases the washer cannot empty the tub in sufficient time to allow for a spin cycle to occur. For this situation, the control has a "Delay Spin" option that can be chosen based on the menus above.

When a time value (other than 0) is programmed for the Delay Spin option, the end of each bath will be extended by the selected time. Therefore, extra time will be allowed for the drain valve to be open and compensate for slow drain capacity. The factory default setting is 0 seconds.

Default Temp:

The "Default Temp" option allows the user to choose which water temperature ("Hot", "Warm", or "Cold") will be active during Idle mode. The customer can, of course, choose other temperatures for the wash bath based on other options described in this manual.

Plus Cycle Options:

The Plus Cycle options allow for the user to prompt the customer for varying vend prices based on additional wash baths chosen. In general, the user can program the additional wash baths in a similar manner to what was described in the "Cycles" Options section.

It also allows the user to return the programmable values to the factory default setting. No plus cycle options are active using the factory default. To reset all values in the Plus Cycles option to factory default, press "Enter" when the "DEFAULT" prompt is shown. Press "Enter" again when the "RESET" prompt is shown to confirm the action.

Figure 6, shown below, shows the next level options for Plus Cycle Options:

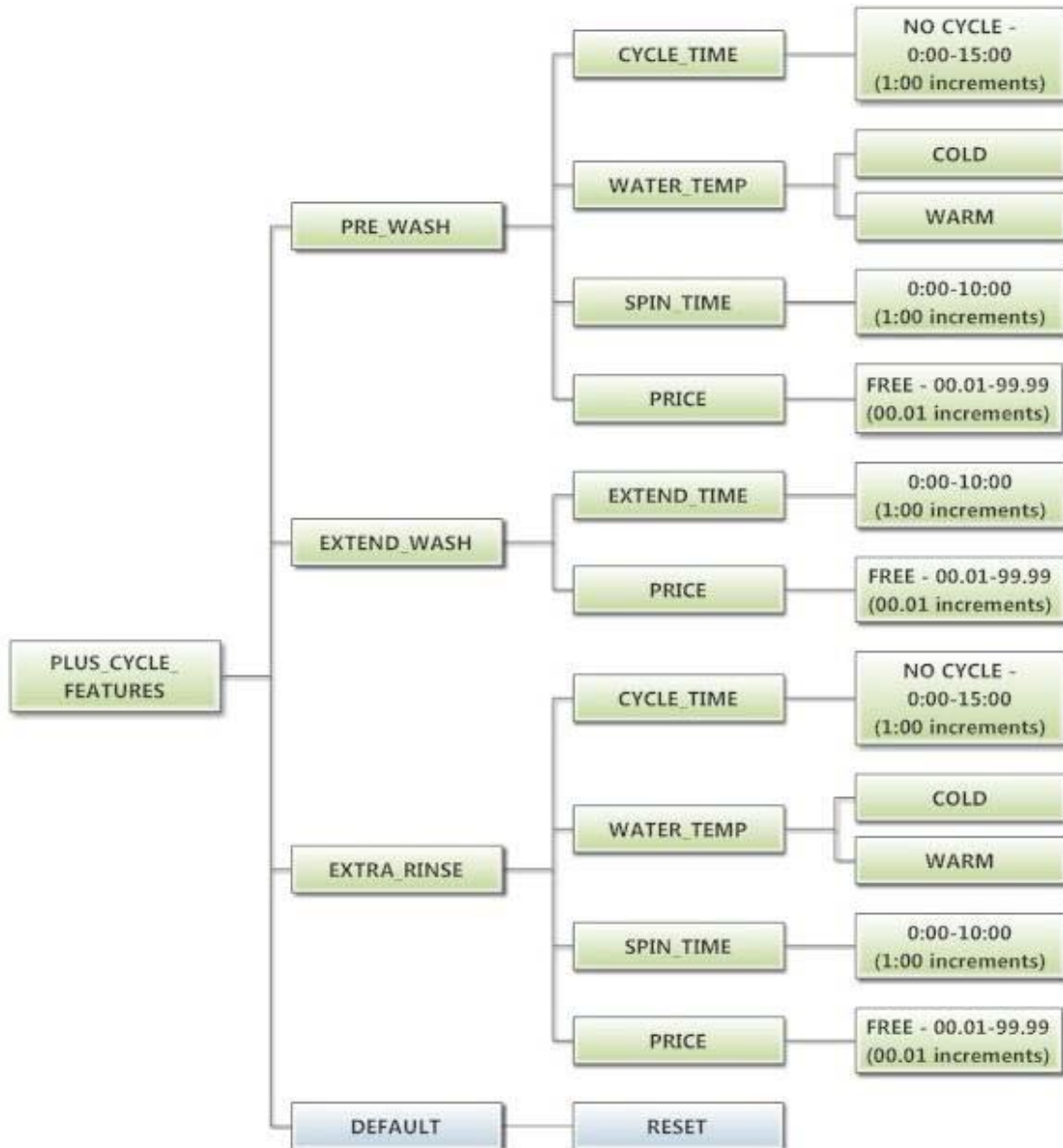

Pre-Wash:

If the user programs a "CYCLE TIME" for Pre-Wash other than 0 ("NO CYCLE"), the feature becomes active. However, the customer will not be prompted to pay an additional vend price for Pre-Wash unless the user programs the Price to a value other than 0 ("FREE").

With the Pre-Wash feature active, an additional bath and, optionally, an additional spin, will occur before the standard Wash bath described in the Cycles Options section.

With the Pre-Wash feature active and a Price value programmed, the customer will be prompted to add additional coins if they wish to purchase the Pre-Wash feature. This will occur after they have entered coins to meet the Base Vend price. If the customer does not meet the vend price of the Pre-Wash feature, the prompt will time out and the Pre-Wash bath will not occur.

Extend Wash:

If the user programs an "EXTEND TIME" for Extend Wash other than 0, the feature becomes active. However, the customer will not be prompted to pay an additional vend price for Extend Wash unless the user programs the Price to a value other than 0 ("FREE").

With the Extend Wash feature active, the standard Wash bath described in the Cycles section will be extended for the additional time selected.

With the Extend Wash feature active and a Price value programmed, the customer will be prompted to add additional coins if they wish to purchase the Extend Wash feature. This will occur after they have pressed the "Start" button to begin the normal Wash cycle. If the customer does not meet the vend price of the Extend Wash feature, the prompt will time out and the additional time will not be added to the Wash bath.

Extra Rinse:

If the user programs a "CYCLE TIME" for Extra Rinse other than 0 ("NO CYCLE"), the feature becomes active. However, the customer will not be prompted to pay an additional vend price for Extra Rinse unless the user programs the Price to a value other than 0 ("FREE").

With the Extra Rinse feature active, an additional bath and, optionally, an additional spin, will occur after the standard Final Rinse bath described in the Cycles Options section.

With the Extra Rinse feature active and a Price value programmed, the customer will be prompted to add additional coins if they wish to purchase the Extra Rinse feature. This prompt will occur during the standard Final Rinse bath. If the customer does not meet the vend price of the Extra Rinse feature, the prompt will time out and the Extra Rinse bath will not occur.

Settings Options:

The Settings options allow for the user to make various programming changes to change how the control operation affects the customer. See below for detailed information on each next level option.

It also allows the user to return the programmable values to the factory default setting. To reset all values in the Settings options to factory default, press "Enter" when the "DEFAULT" prompt is shown. Press "Enter" again when the "RESET" prompt is shown to confirm the action.

Figure 7, shown below, shows the next level options for Settings Options:

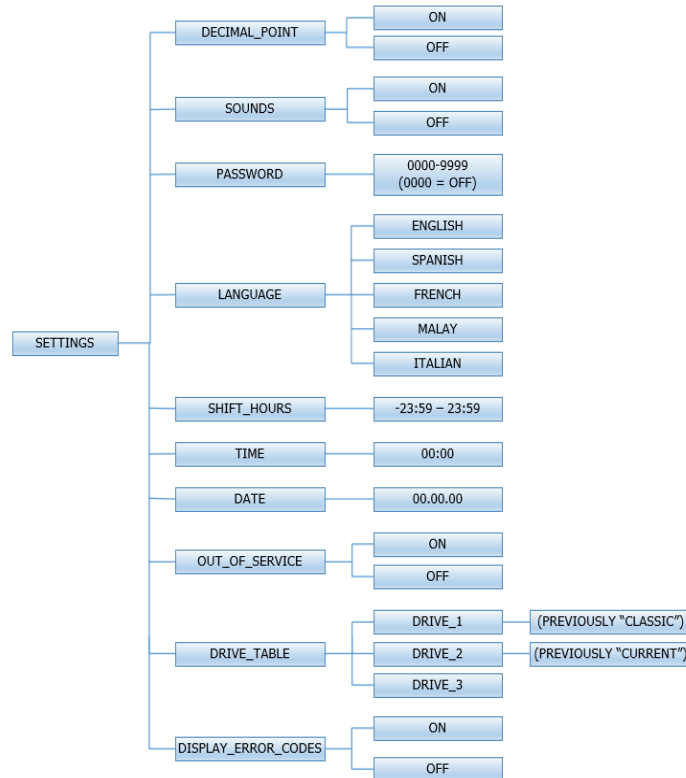

Decimal Point:

If the user programs the Decimal Point to "OFF", control display will not show a decimal point on any vend price values. The factory default is "ON".

Sounds:

If the user programs the Sounds to "OFF", the control will not sound the enunciator at the end of a wash cycle. The factory default is "ON".

Password:

If the user programs the Password to any value other than 0000, the control will prompt the user to enter a password (the programmed value) before manual programming can be accessed. The factory default is "0000" (no password).

Note that if the user forgets the Password, it can be reset to factory default (no password), by performing a hard reset on the control. Please refer to the appropriate section of this manual to understand how to perform a hard reset.

The individual digits of the Password can be set by using the "Up" or "Down" buttons to change the number that is flashing. Once the desired number is chosen for a single digit, press the "Enter" button to move to the next one. Once all four desired digits are chosen, the "Enter" button must be held down for 3 seconds to confirm that the complete password should be set.

Language:

The control uses English for the default language of the customer prompts. Alternatively, the user can choose Spanish or French for the customer display prompts. However, all other prompts, such as Manual Programming, USB Programming and any Error Codes will still display in English.

Shift Hours:

The control uses a Real Time Clock (RTC) to internally track the time and date. The RTC continues operation even if the control loses external power. The RTC is set for Central Standard Time and no daylight savings.

Because the machine may be located in another time zone, the user can choose to create an alternate time & date that tracks in parallel to the RTC. When this alternate time is chosen, or shifted from the RTC, the alternate time will be used to, for example, track error code occurrences and set time-of-day pricing changes.

The hours in "SHIFT HOURS" can be set by using the "Up" or "Down" buttons to change the number that is flashing. Once the desired hour shift is chosen, press the "Enter" button to move to the minutes. Once the hours and minute shift are both chosen, the "Enter" button must be held down for 3 seconds to confirm that the complete shifted time is set.

Time:

The control uses a Real Time Clock (RTC) to internally track the time and date. The RTC continues operation even if the control loses external power. The RTC is set for Central Standard Time and no daylight savings. However, if a problem occurs and the RTC time is not accurate, it can be reset to the current time using this option.

The hours in "TIME" can be set by using the "Up" or "Down" buttons to change the number that is flashing. Once the desired hour is chosen, press the "Enter" button to move to the minutes. Once the hours and minute are both chosen, the "Enter" button must be held down for 3 seconds to confirm that RTC is meant to be reset to the complete entry.

Date:

The control uses a Real Time Clock (RTC) to internally track the time and date. The RTC continues operation even if the control loses external power. The RTC is set for the current date. However, if a problem occurs and the RTC date is not accurate, it can be reset to the current date using this option.

The day of the month in "DATE" can be set by using the "Up" or "Down" buttons to change the number that is flashing. Once the desired day of the month is chosen, press the "Enter" button to move to the month of the year. Once the desired month of the year is chosen, press the "Enter" button to move to the year. Once the day, month and year are all chosen, the "Enter" button must be held down for 3 seconds to confirm that RTC is meant to be reset to the complete entry.

Drive Table:

The control knows what model of washer it is installed in based on various inputs including information it receives from the Variable Frequency Drive (VFD). However, because multiple VFD's can be used on the same model, depending on when it was manufactured, the "DRIVE TABLE" option is available. "DRIVE ERROR 1" will display on the control when the Drive Table setting does not match the appropriate VFD in the washer.

- a. Choose "Drive 3" for C4 models (ex. WC0600XA-12EC4X-)
- b. Choose "Drive 2" for C1, C2, or C3 models (ex. WC0600XA-12EC2X-)
- c. Choose "Drive 1" for WCAD models (ex. WCAD40KCS)

Usage Menu:

The Usage menu allows for the user to track data about machine usage. See below for detailed information on each sub menu option.

Figure 8, shown below, shows the sub menu options for Usage:

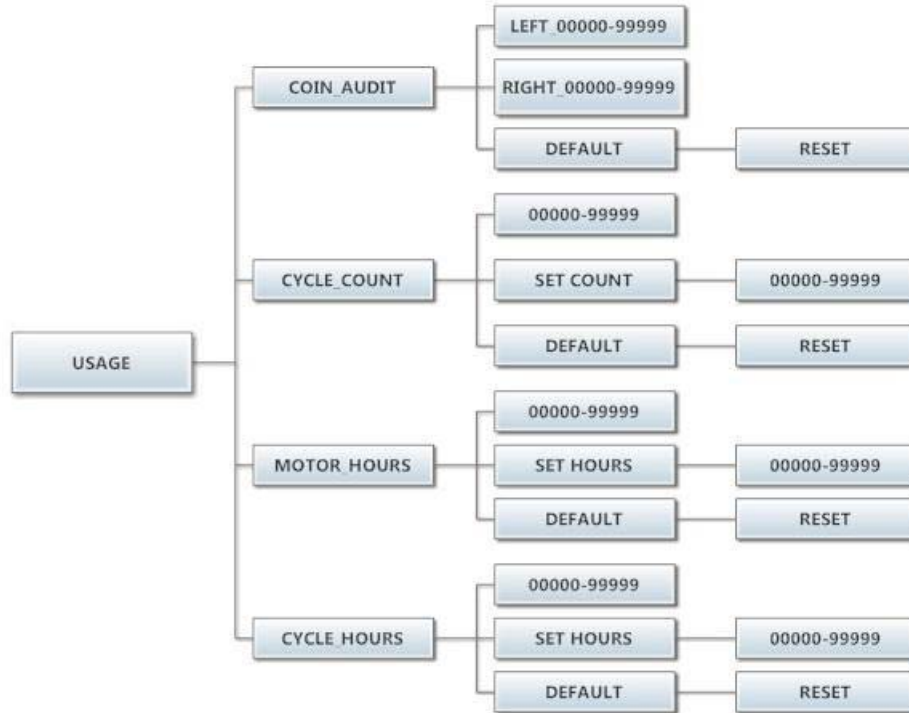

Coin Audit:

The coin audit field shows the accumulation of coin pulses that were sent to the control over each of the left and right coin inputs. Note that this is a count of coin pulses, not an accumulated report of vend value. The user can also return the coin audit amounts to the factory default setting (zero). To reset all coin audit values, press "Enter" when the "DEFAULT" prompt is shown. Press "Enter" again when the "RESET" prompt is shown to confirm the action.

Cycle Count:

The cycle count field shows the accumulation of wash cycles that have occurred. Note that this is a count of cycles, not of hours accumulated.

The user can also set the count value to a designated number. For example, if it is necessary to replace the control on a machine, the new control could be programmed to show the cycle count value that was recorded by the previously installed control. The individual digits of the count can be set by using the "Up" or "Down" buttons to change the number that is flashing. Once the desired digit of the count is chosen, press the "Enter" button to move to the next digit. Once the complete count is chosen, the "Enter" button must be held down for 3 seconds to confirm the action.

The user can also return the cycle count to the factory default setting (zero). To reset the cycle count, press "Enter" when the "DEFAULT" prompt is shown. Press "Enter" again when the "RESET" prompt is shown to confirm the action.

Motor Hours:

The motor hours field shows the accumulated hours of operation for the motor. In many cases, it will match the cycle hours of the machine. However, separate fields are provided in the event that a motor is replaced on a machine.

The user can set the motor hours to a designated number. For example, if it is necessary to replace the control on a machine, the new control could be programmed to show the motor hours that were recorded by the previously installed control. The individual digits of the hours count can be set by using the "Up" or "Down" buttons to change the number that is flashing. Once the desired digit of the hours is chosen, press the "Enter" button to move to the next digit. Once the complete hours are chosen, the "Enter" button must be held down for 3 seconds to confirm the action.

The user can also return the motor hours to the factory default setting (zero). To reset the motor hours, press "Enter" when the "DEFAULT" prompt is shown. Press "Enter" again when the "RESET" prompt is shown to confirm the action.

Cycle Hours:

The cycle hours field shows the accumulated hours of operation for the washer. In many cases, it will match the motor hours of the machine. However, separate fields are provided in the event that a motor is replaced on a machine. See the Motor Hours description for more information.

Control Menu:

The Control menu allows for the user to observe important technical information for the control and Variable Frequency Drive system. No changes can be made at this menu. See below for detailed information on each sub menu.

Figure 9, shown below, shows the sub menu options for Control:

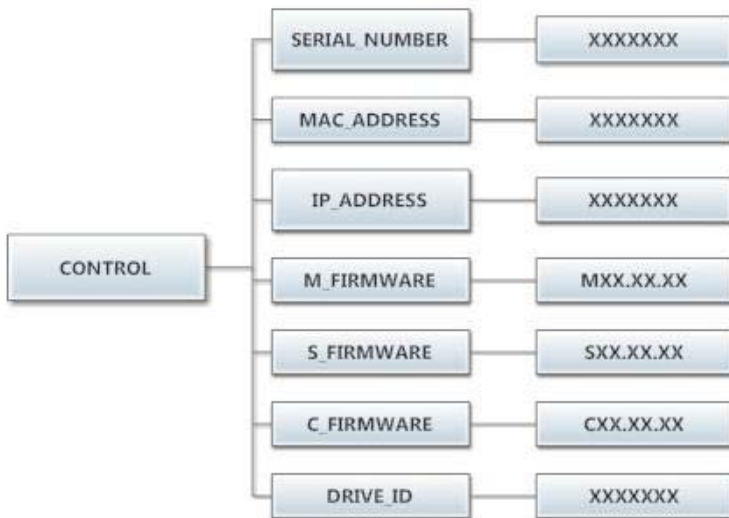

Serial Number:

The serial number is the control serial number.

MAC Address:

The MAC Address is a unique identifier designated to the control by the manufacturer. It allows the control to be recognized by network routers.

IP Address:

The IP Address is the identifier given to the control by a network system.

M Firmware:

The M Firmware is the Main Firmware currently loaded onto the control.

S Firmware:

The S Firmware is the Secondary Firmware currently loaded onto the control.

C Firmware:

The C Firmware is the Communications Firmware currently loaded onto the control.

Drive ID:

The Drive ID is the code that represents the size of the Variable Frequency Drive and parameters loaded into it, corresponding with the washer model.

USB Menu:

The USB menu allows for the user to move programming files back and forth from a common USB memory stick.



2.11.5 MAXIMUM SPIN SPEED ADJUSTMENT (All washers except T-950)

If desired, the washer can be adjusted to limit the maximum extract spin speed for all wash cycles.

To make this adjustment, a jumper wire must either be installed or removed on the Variable Frequency Drive (VFD), depending on the washer model and desired speed. This Dexter jumper part number 8220-057-036 (qty 1) is factory supplied on terminal points "10V" and "RC". Remove this jumper to make new jumper connections if necessary. Refer to figure below for the approximate location of the control terminations on the Variable Frequency Drive (VFD) and for appropriate jumper connection points indicated with an "X" for the desired maximum spin speed setting. If no adjustment to the default spin speed is desired, do not remove or add any wires on VFD.

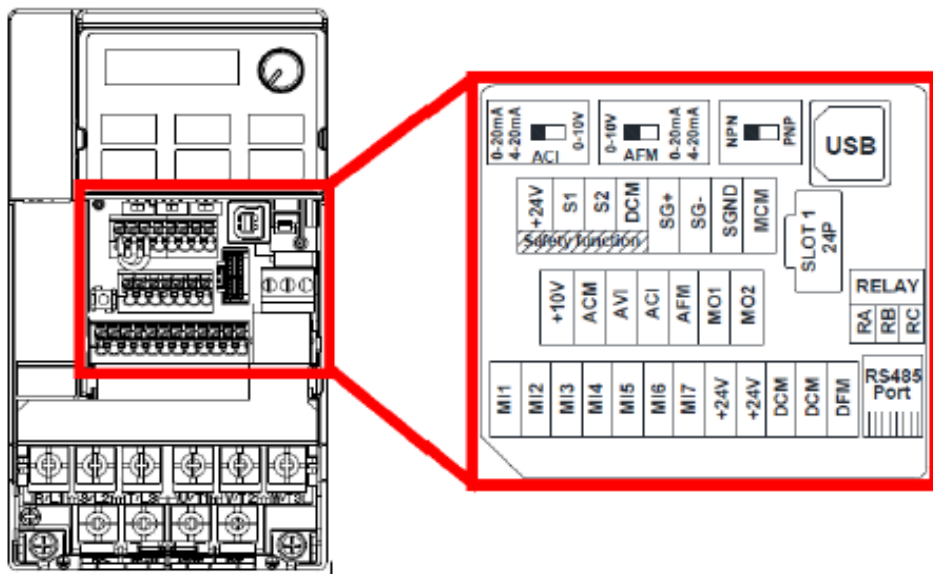

Control Terminations on Variable Frequency Drive

V Series Washer Model	Max Spin Speed	Jumper Terminal Locations on Variable Frequency Drive (VFD)													
		MI1	MI2	MI3	MI4	MI5	MI6	DCM (Left)	DCM (Right)	24V	ACM	AVI	ACI	10V	MO1
T-300, T-400,	60 G											X		X	
T-600, T-900,	80 G				X		X								
T-1200	100 G	Default Setting (No Jumper Required)													
T-350, T-450, T-750	60 G										X			X	
	100 G				X		X								
	140 G					X	X								
	200 G	Default Setting (No Jumper Required)													
T-650, T-1450	100 G										X			X	
	140 G	REMOVE Brown Jumper Between MI5/MO1													
	200 G	Default Setting (No Jumper Required)													

Spin Speed Adjustment Jumper Locations

MAXIMUM SPIN SPEED ADJUSTMENT (T-950 Only)

The variable frequency drive allows for varying acceleration during Final Spin on T-950 models. It is important to utilize a decreased acceleration rate when the application power is low. This acceleration rate is determined by a white wire jumper installed on the drive terminal block from +10V to AVI.

Remove the wire jumper when input power is between 208 and 219 volts. Keep the jumper installed when input power is between 220 and 240 volts. Reference the drawing below for the jumper location.

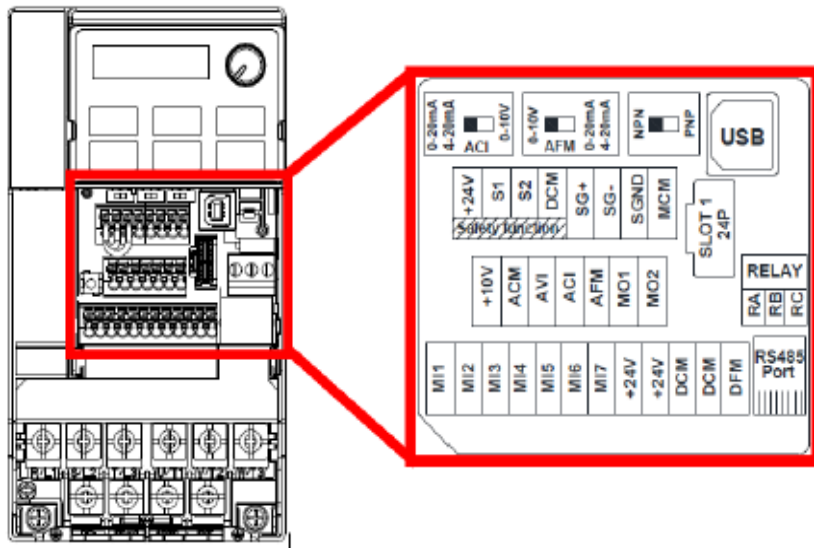

Control Terminations on Variable Frequency Drive

V Series Washer Model	Input Voltage	Max Spin Speed	Jumper Terminal Locations on Variable Frequency Drive (VFD)												
			MI1	MI2	MI3	MI4	MI5	MI6	DCM (Left)	DCM (Right)	24V	ACM	AVI	ACI	10V
T-950	240V	140 G	REMOVE Brown Jumper Between MI5/M01												
		200G											X		X
	208V	140 G	REMOVE Brown Jumper Between MI5/M01												
		200G	No Jumper required												

T-950 Spin Speed Adjustment Jumper Locations

Section 4:

Trouble Shooting

Common Troubleshooting Solutions

Symptom	Probable Cause	Suggested Remedy
Machine does not start	Power Supply	Check these areas: Circuit breakers, Voltage, Power leads, Power connections. Is front display LED showing a dollar amount.
	Door Switch	Check for continuity through door switch when door is closed. If no continuity, adjust or replace door switch.
	Control Breaker or Fuse	Check 1.5 amp (T-950 and T-1200 use 2.5amp) breaker or fuse for continuity. If no continuity, replace breaker or fuse.
	Control Transformer	Check voltage output from control transformer for 120VAC. If voltage is incorrect, replace transformer.
	Coin Acceptor	Check coin acceptor to make sure there is no blockage or damage. clean or replace acceptor.
	Check PCB board	Check all wire connections for sure contacts.
	Check wiring between PCB	Check data cable. This is the cable with the phone type connectors on the main PCB control and the VFD. With the power removed unplug and check for damage, replug and retry washer.
	Check Relay PCB	Check all wire connections for sure contact.
	Check Door Motor	Check that 120 v power is at Motor after start button is pushed.
Machine will not accept and count coins	Coin Acceptor	Check coin acceptor switch for any type of blockage or damage. Clean, adjust or replace the acceptor.
	Power Supply	Check these areas: Circuit breakers, Voltage, Power leads, Power connection.
	Door Closed Safety Switch	Check door closed switch at door hinge for proper operation.
	Door Handle Closed Switch	Check single door closed switch at left side of door handle to close when handle is vertical.
	Control Breaker or fuse	Check breaker or fuse for continuity. If no continuity, replace breaker or fuse. The T-300 through T-950 use the 1.5 amp fuse. The T-1200 and t-1450 uses A 2.5 amp fuse.
	Main PCB	Replace
Door does not lock	Check display for fault code	Does Door Lock Error show on the front of display. If yes follow tests described in fault code section.
	Door locking Motor	Check to insure that Motor is receiving 120VAC from main relay PCB. If it is, replace solenoid.
	Door Switch	Check for continuity through door latch switch when door closed. If no continuity, adjust or replace door switch.
Door will not open	Thermoactuator	Check to see if thermoactuator(s) and/or its mechanism is stuck or binding and not allowing the door lock solenoid to open. Check to be sure that the locking thermoactuator is not receiving 120VAC during the last 1 1/2 minutes of the cycle. Also check to see that the unlocking thermoactuator is receiving 120VAC during the last minute of the cycle. If the thermoactuators do not receive voltage at the correct times, change the timer. If the timing and voltage are correct, replace the thermoactuator.

Common Troubleshooting Solutions

Symptom	Probable Cause	Suggested Remedy
Door will not open	Door Rod	Check to see that door rod from solenoid to lock ass'y is long enough to allow lock ass'y to disengage. If not, adjust rod.
	Gear Motor	Check the door lock motor. Make sure the motor is not stuck or in a bind. If motor does not move freely, replace locking motor.
No hot water in detergent dispenser	Water Valve Coil	Check coil continuity at terminals and replace if no continuity. 120 V power only on for 20 second in wash bath.
	Water Inlet	Check water inlet screens for blockage and clean screens if necessary.
	Water	Check to insure that water is turned on and operating.
	P-20 Wire Harness	Check black & white harness.
Hot water does not enter tub in wash	Water Valve Coil	Check coil continuity at terminals and replace if no continuity. Check for 120 V power from main relay PCB
	Water Inlet	Check water inlet screens for blockage and clean if necessary screens
	Water	Check to insure that water is turned on and operating.
	Blk or Wht wire at main controller	Check black or white wires at Molex plug on PCB at main controller and at relay PCB.
	Pressure Switch	Check pressure switch continuity between terminals . If no continuity, check pressure switch hose for obstruction. If hose okay, change pressure switch.
No cold water to tub in wash	Water Valve Coil	Check coil continuity at terminals and replace if no continuity.
	Water Inlet Screens	Check water inlet screens for blockage and clean if necessary.
	Water	Check to insure that water is turned on and operating.
	Blk or whit wire at controller and main relay PCB	Check black or white wires at Molex plug on PCB at main controller and at relay PCB.
	Pressure Switch	Check pressure switch continuity between terminal contacts. If no continuity, check pressure switch hose for obstruction. If hose okay, change pressure switch.
Water comes in but level does not rise	Drain Valve (open)	Check these areas • Drain valve blockage • Drain valve motor and gear train. If power but drain valve does not close, replace valve. • Power to the drain valve. If no power to drain valve, check (brn/yel) circuit for power.
	Blk or whit wire at controller	Check black and white wires at molex plug on main PCB controller and at main relay PCB
Water does not flush softener compartment.	Water Valve Coil	Check coil continuity at terminals and replace if no continuity.
	Water Inlet Screens	Check water inlet screens for blockage and clean if necessary.
	Water	Check to insure that water is turned on and operating.

Common Troubleshooting Solutions

Symptom	Probable Cause	Suggested Remedy
Water level too high	Pressure Switch	Check for blockage in pressure switch hose. Check for pressure switch opening circuit across terminals. Replace switch if contacts do not open.
Water drains slowly	Drain System	Check hoses and drain valve for blockage. Clean of inadequate size, if necessary. Check building drains for blockage
Machine does not turn	VFD	Check VFD by removing top panel and record power or fault lights are illuminated. If the fault light is on, turn power off to machine at breaker for 2 minutes and turn power back on to reset. If still no display replace VFD
Machine tumbles in one direction	VFD	Remove Top cover record if power light or fault lights are displayed, view front control for related codes. See fault code section for more info.
	VFD	Inspect yellow enable wires from main relay PCB and at VFD
Excessive vibration	Mounting System	Check these areas: • Strength of mounting structure, concrete or base. • Mounting bolts may be loose and need tightening.
	Drive Belt	Worn drive belt can cause vibration and noise.
	Loading	Note: Small loads contribute to out of balance loading and increase vibration.
Machine does not spin	Pressure Switch	Check pressure switch for continuity across terminals #21 & #22 indicating pressure switch has reset to the empty position. If no continuity, change pressure switch.
Machine starts and does not operate	VFD	Check yellow enable wires from relay PCB P13 & motor P14 to VFD advances through cycle are connected. Check fault code on VFD before removing power from the drive. Check orange P-15 wire for signal from door switches.
Machine does not stop	Main PCB	Main PCB controls time cycle at end of cycle
	Braking Resistors	Check braking resistors for continuity. Verify ohms resistance by Molex.
Water leakage around loading door	Door Adjustment	Door may need adjustment due to abuse or wear. Check tightness around perimeter using a dollar bill. Adjust left to right tightness by shims at door lock or hinge side. It is important to center gasket to tub opening before tightening door to hinge bolts. Chalk may be used on tub front to show point of contact with tub. If gasket is deformed, worn, or damaged, replace. Refer to parts section for door gasket expander kit.
Machine Starts goes Directly to end of cycle	E-Stop button or switch	If machine says PUSH then goes directly to "0" or "00" may be bad stop Button or switch. Replace switch assembly.

Troubleshooting Machine Fault Errors

Displayed on front of washer

The following pages are a description of fault codes that will appear on the front of the washer. There is a chart format that shows what fault code that will be displayed at washer front. These codes displayed may stop machine operation or may not stop machine Please check chart before removing power to reset. PLEASE NOTE: CHECK DRIVE FAULT CODE BEFORE POWERING MACHINE DOWN!

Fault	Description	Customer Action	
DOOR LOCK ERROR	The door failed to close and lock or The door failed to remain locked during the cycle.	Condition	This error is when the Door Locked signal is not received within one second after the start of the cycle. After three attempts to start the washer.
		Delay	Immediate
		Action	When the error occurs, the Door Lock Solenoid will be turned off; all other outputs will be turned off.
		Solution	Check VFD fault light. Check to hear if door motor engaged. Turn off the power to the washer. Check wire connections to door /lock switches. Check wire connections from switches to controller. Check P-4 Door/Lock wire connections at PCB controller. Adjust the door lock mechanism. (See on line service manual or video)
SLOW FILL ERROR	Slow Fill Error	Condition	This error is when a low water level is not reach within 7 minutes.
		Delay	Immediate
		Action	The washer cycle will continue
		Solution	Turn off the power to the washer. Check the operation of the water valves. Check the incoming water pressure. Check for blocked or restricted water flow. Check to ensure the drain valve is functioning properly.
MEMORY ERROR	Checksum or Out of Range Error	Condition	Memory error in the controller. The memory checksum is wrong or a parameter value is out of range.
		Delay	Immediate
		Action	Stop the washer and turn off all the outputs.
		Solution	Check VFD fault light before turning off power. Try a soft Reset of the controller with the white button. If problem persist replace PCB controller.

Fault	Description	Customer Action	
COMM ERROR 1	I2C Bus Error	Condition	Washer controller communication error on the I2C bus. Both the main slave micro and the master micro can be in this error state. The slave micro error is recoverable at any time, if I2C communication resumes. The master micro error is permanent.
		Delay	The main slave starts displaying this error after 6 seconds of no (valid) I2C activity. The master micro goes into this permanent error state after 8 seconds of no (valid) I2C activity
		Action	Stop the washer and turn off all outputs.
		Solution	Check VFD fault light before turning off power. Try the data cable first. Move around cable and remove any side loading tension from data cable connector ends. Check connection P23 to P15. Turn power back on to the washer. If the problem returns, replace the PCB washer controller.
COMM ERROR 2	Wrong Washer Size Jumper Configuration	Condition	Invalid washer size jumper (harness) configuration.
		Delay	Immediate (after the wrong size jumper configuration is read). Washer size/type inputs are read only at power up, before starting a cycle, once every 24 hours, and in factory test mode.
		Action	Stop the washer.
		Solution	Check VFD fault light before turning off power. If the controller was installed in a different size machine before being installed in this machine, a problem can occur. If someone has been doing repairs on the washer, check for the correct size drive. It can also be caused by pressure switch harness. Check to ensure the correct harness is installed. The control can be reset by holding program button on controller during startup (soft reset). Check orange wire at Molex connector on controller coming from pressure switch or replace pressure switch harness.
COMM ERROR 3	Washer Size or Type Changed	Condition	The washer size or washer type configuration has changed.
		Delay	Immediate (after the size jumper configuration is read). Washer size/type inputs are read only at power up, before starting a cycle, once every 24 hours, and in factory test mode.
		Action	Stop the washer.
		Solution	Check VFD fault light before turning off power. Check to ensure all the harnesses are properly connected to the controller. Check to ensure the VFD drive horsepower is proper for this size of washer. The control can be reset by holding program button on controller during startup (soft reset). Check orange wires at Molex connector on controller coming from pressure switch.

Fault	Description	Customer Action	
COMM ERROR 4	VFD Non Existent or communication fault	Condition	This error is when the washer controller cannot communicate with the drive.
		Delay	Delay time is 2 seconds
		Action	Stop the machine and clear the cycle. Keep the door locked until the machine has stopped moving and then unlock the door.
		Solution	Check the data communication cable between the washer computer and the variable frequency drive (VFD). Step 1: Make sure the cable did not become unplugged during operation. Step 2: Make sure that the cable is not being pulled sideways at either the washer controller, or the VFD, plug end. If both ends of the communications cable are plugged in the washer computer and VFD and there is no tension on the communications cable pulling it from side to side, then replace the cable. Step 3: Inspect both female connection points at PCB controller and at VFD. These may need replacement if they cannot be reset.
COMM ERROR 5	VFD Communication Fault	Condition	This error is a data error on communications between the controller and the VF drive
		Delay	Delay time is 12 seconds.
		Action	Stop the machine and clear the cycle. Keep the door locked until the machine has stopped moving and then unlock the door.
		Solution	The CE errors are communications errors. Data Cable noise can cause the majority of these errors. Check VFD fault light before turning off power. Check the data cable between the controller and the drive. Replace data cable if it appears damaged and fault appears again. Please note that this fault will occur if you turned main power off and on to quickly. (See Note below)
COMM ERROR 6	VFD Communication Fault	Condition	This error indicates that a VFD exception error is set
		Delay	Occurs following the "DELAY" error (see corresponding detail)
		Action	Stop the machine and clear the cycle. Keep the door locked until the machine has stopped moving and then unlock the door.
		Solution	The washer will not restart until the power is removed and re-applied.

Fault	Description	Customer Action	
COMM ERROR 7	Communication Bus Error	Condition	If a state-of-health message reply is not seen by the master microprocessor from the UC3 microprocessor after 10 minutes, the master will reset the UC3 and restart the 10 minute timer. Again, after 10 minutes, if a state-of-health message is not received by the master, it will reset the UC3 a second time. After 10 minutes, the master will reset the UC3 a final time and post a COMM ERROR 7. Note: When the master resets the UC3, the control will disconnect from the network. If the first reset is not successful, the control will not be able to reconnect to the network, USB or card reader functions.
		Delay	3 cycles of 10 minutes (see above)
		Action	Stop the machine and clear the cycle. Keep the door locked until the machine has stopped moving and then unlock the door.
		Solution	The washer will not restart until the power is removed and re-applied.
COMM ERROR 8	VFD Communication Fault	Condition	This error is caused when the VFD reports a frequency value that is out of range
		Delay	Delay time is 35 seconds
		Action	Stop the machine and clear the cycle. Keep the door locked until the machine has stopped moving and then unlock the door.
		Solution	The washer will not restart until the power is removed and re-applied.
PCB ERROR1	Controller Internal Fault	Condition	This error is an internal failure of the washer controller electronics.
		Delay	Immediate
		Action	Stop the machine and clear the cycle. Keep the door locked until the machine has stopped moving and then unlock the door.
		Solution	Check VFD fault light before turning off power. Try a soft Reset of the controller with the white button. If problem. Replace PCB controller.
PCB ERROR 2	Controller Internal Fault	Condition	This error is an internal failure of the washer controller related to inputs being matched between the master and slave micros
		Delay	Immediate
		Action	Stop the machine and clear the cycle. Keep the door locked until the machine has stopped moving and then unlock the door.
		Solution	The washer will not restart until the power is removed and re-applied.

Fault	Description	Customer Action	
SLOW DRAIN ERROR	Drain Error	Condition	This error is when an empty water level is not reach within 7 minutes.
		Delay	Immediate
		Action	The washer cycle will continue. Do not spin the tumbler with out reaching an empty water level. If empty water level is not reached, agitate during the normal spin time.
		Solution	Check VFD fault light before turning off power. Check to ensure the drain valve is operating properly (slow drain has potential to cause this code). Check to ensure the pressure switch tube is clear of any blockage, and the pressure switch is operating properly. Check the pressure switch harness.
SPIN STOP ERROR	Stop Error	Condition	This error is when the washer does not stop spinning within 150 seconds after receiving the command.
		Delay	Immediate
		Action	Keep the door locked until the machine has stopped moving and then unlock the door.
		Solution	Check VFD fault light before turning off power. Inspect the braking resistors and measure the resistance. Check connecting wiring from braking resistor to the drive mounted in the top of the washer. Reset the drive and try again. Possibly incorrectly programmed drive.
DRIVE ERROR 1	Washer size/ VFD size mismatch	Condition	This error is when the drive size does not match the washer size.
		Delay	Immediate. (after the size jumper configuration is read). Washer size/type inputs are read only at power up, before starting a cycle, once every 24 hours and in factory test mode
		Action	Stop the machine and clear the cycle. Keep the door locked until the machine has stopped moving and then unlock the door
		Solution	Check VFD fault light before turning off power. If the controller was installed in a different size machine before being installed in this machine, a problem can occur. If someone has been doing repairs on the washer, check for the correct size drive. It can also be caused by pressure switch harness. Check to ensure the correct harness in installed. The control can be reset by holding program button on controller during startup (soft reset). Check orange wire at Molex connector on controller coming from pressure switch or replace pressure switch harness.

Fault	Description	Customer Action	
DRIVE OC	VFD Over-current Fault	Condition	This error is an over-current on the VF drive
		Delay	Delay time is 35 seconds
		Action	Stop the machine and clear the cycle. Keep the door locked until the machine has stopped moving and then unlock the door.
		Solution	Step 1: Check to make sure the washer cylinder turns freely by hand. If it turns freely, continue to step 2. If it does not, remove the belt and see if the motor turns freely by hand. If the motor turns freely, then check for obstructions in the cylinder or check the bearings. If the motor does not turn freely, replace the motor. Step 2: Check the motor wires for a short circuit between leads. If there are motor leads that have conductors touching, separate them and insulate them. If the wires are broken, splice them together or replace the motor. Step 3: Check braking resistors to see if they measure the correct resistance. If a resistor does not measure the proper value, replace it.
DRIVE OV	VFD Over-voltage Fault	Condition	This error is over-voltage on the VF drive
		Delay	Delay time is 35 seconds.
		Action	Stop the machine and clear the cycle. Keep the door locked until the machine has stopped moving and then unlock the door.
		Solution	"Step 1: Measure the supply voltage to the VFD on the L1, L2 (or N), and L3 (if connected to three phase power). the supply voltage should be from 187 to 264 VAC or 108 to 132 VAC for a 120 VAC VFD. Also make sure the supply wires on L1, L2 (or N) and L3 (if connected to three phase power) are securely connected. Step 2: Check the braking resistor connections at the VFD. The terminal screws should be tight. Once of the braking resistor wires should be connected to terminal B2. Step 3: Measure each braking resistor separately to make sure they are the correct resistance. (200 for 1 and 2 Hp VFD and 160 for 3 Hp VFD). Step 4: If you have a 240 VAC, high leg voltage supply, try disconnecting the high leg. If this cures the problem, either leave the high leg disconnected, connect a transient voltage surge suppressor (with some form of filtering) at the voltage supply panel, connect a line choke on the high leg or install a VFD filter. "

Fault	Description	Customer Action	
DRIVE OH	VFD Overheat Fault	Condition	This error is over-heating on the VF drive
		Delay	Occurs following the "DELAY" error (see corresponding detail)
		Action	Stop the machine and clear the cycle. Keep the door locked until the machine has stopped moving and then unlock the door.
		Solution	The washer will not restart until the power is removed and re-applied.
DRIVE OL	VFD Overload Fault	Condition	This error is overload on the VF drive
		Delay	Occurs following the "DELAY" error (see corresponding detail)
		Action	"DRIVE OL"
		Solution	The washer will not restart until the power is removed and re-applied.
DRIVE GFI	VFD Ground Fault	Condition	This error is a ground fault interruption on the VF drive
		Delay	Occurs following the "DELAY" error (see corresponding detail)
		Action	Stop the machine and clear the cycle. Keep the door locked until the machine has stopped moving and then unlock the door.
		Solution	The washer will not restart until the power is removed and re-applied.
DRIVE LV	VFD Low Voltage	Condition	This error is low voltage on the VF drive
		Delay	Occurs following the "DELAY" error (see corresponding detail)
		Action	Stop the machine and clear the cycle. Keep the door locked until the machine has stopped moving and then unlock the door.
		Solution	The washer will not restart until the power is removed and re-applied.
DRIVE IF	VFD Internal Fault	Condition	This error is an internal VF drive error
		Delay	Occurs following the "DELAY" error (see corresponding detail)
		Action	Stop the machine and clear the cycle. Keep the door locked until the machine has stopped moving and then unlock the door.
		Solution	The washer will not restart until the power is removed and re-applied.

Fault	Description	Customer Action	
INVALID DRIVE	Drive is not the correct Dexter version of the Delta E-drive	Condition	The error indicates the VF drive is not a Dexter version of the Delta E-drive.
		Delay	Immediate (after the Dexter indication value is read from drive). Drive indication value is read only at power up, before starting a cycle, once every 24 hours, and in factory test mode.
		Action	Stop the machine and clear the cycle. Keep the door locked until the machine has stopped moving and then unlock the door.
		Solution	The washer will not restart until the power is removed and re-applied.
SECONDARY FUSE ERROR	Factory program error	Condition	This error occurs when the fuse settings for the Slave/Secondary microprocessor have not been set correctly during factory programming
		Delay	None
		Action	When detected, the washer control shall not be operational.
		Solution	The control must be re-programmed with the factory programming tool.
MAIN FUSE ERROR	Factory program error	Condition	This error occurs when the fuse settings for the Master/Main microprocessor have not been set correctly during factory programming
		Delay	None
		Action	When detected, the washer control shall not be operational.
		Solution	The control must be re-programmed with the factory programming tool.
DELAY	Communication loss	Condition	This is an intermediate error code that displays as the control is attempting to re-establish communications with the variable frequency drive. It is a condition of other specified Error Codes (for example Comm Error6).
		Delay	4 cycles of 10 seconds if during tumble portion of cycle
			4 cycles of 2 minutes if during spin portion of cycle
		Action	Prompt is displayed during each of the specified 10 second or 2 minute periods. Error condition (such as Comm Error4) occurs, but Delay is shown instead of specific Error Code. Action during this time is dependent on the specific error code that caused it.
Solution	No exit strategy. Either communication is re-established or the specific Error Code eventually occurs.		

Fault	Description	Customer Action	
CRC ERROR	Firmware corrupted	Condition	This error occurs the washer control firmware fails a CRC check.
		Delay	None
		Action	When detected, the dryer control shall not be operational.
		Solution	The error is fatal. The control must be replaced.

Vended Drive Motor Inverter Type Motor-Winding Resistance Chart

T650 C-Series Express Washer

Motor	Winding	Wire #	Resistance	
			Minimum	Maximum
T750 1ph or 3ph 60hzMain (wash & spin)		T1 & T2	2.25	2.61
Dexter #9376-319-001		T2 & T3	2.25	2.61
Marathon #		T1 & T3	2.25	2.61

T750 C-Series Express Washer

Motor	Winding	Wire #	Resistance	
			Minimum	Maximum
T750 1ph or 3ph 60hzMain (wash & spin)		T1 & T2	.944	1.097
Dexter #9376-329-001		T2 & T3	.944	1.097
Marathon #		T1 & T3	.944	1.097

T950 C-Series Express Washer

Motor	Winding	Wire #	Resistance	
			Minimum	Maximum
T950 1ph or 3ph 60hzMain (wash & spin)		T1 & T2	.944	1.097
Dexter #9376-329-001		T2 & T3	.944	1.097
Marathon #		T1 & T3	.944	1.097

T1450 C-Series Express Washer

Motor	Winding	Wire #	Resistance	
			Minimum	Maximum
T1450 1ph or 3ph 60hzMain (wash & spin)		T1 & T2	.435	.505
Dexter #9376-326-001		T2 & T3	.435	.505
Marathon #		T1 & T3	.435	.505

NOTE: Resistance values are measured at the stator. Values at the end of the motor wiring harness may be slightly higher.

Section 5:

Machine Service Procedures

Top Panel Removal

- Step 1:** Remove 4 screws that hold detergent dispenser to top panel. (T750 with top soapdish) if front soap dish go to step 2
- Step 2:** Unlock top panel lock with the 6324 key.
- Step 3:** Raise top panel, slide to the rear to release from back clips and lift off.

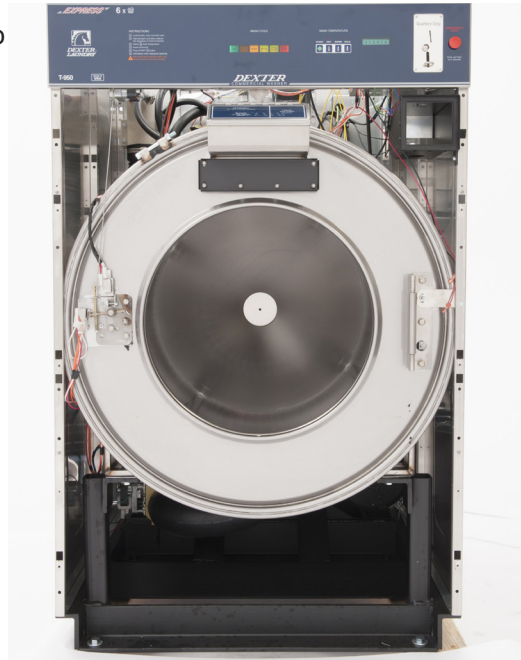

Front Panel Removal

- Step 1:** Remove the loading door by first removing the two lower screws of the lower hinge clamp and lifting the door off of the hinge assembly.
- Step 2:** Remove 2 screws between front panel top and front (located behind control panel).
- Step 3:** Remove the two screws in the middle of the front panel.
- Step 4:** Pull panel out at the bottom to about a 45 degree angle to detach the top lip and remove.

Back Panel Removal

- Step 1:** Remove all screws holding back panel in position except the bottom row.
- Step 2:** The bottom row of screws are slotted and only need to be loosened and to lift off panel.

NOTE: The back panel is not only a safety requirement but also contributes to the rigidity of the cabinet.

Drain Valve Access

For access to drain valve, remove lower service panel. The drain valve is a ball type and is powered closed by the drain valve motor. It is mounted under the washer tub on the left side. It is spring loaded open. If power is interrupted to the washer, the motor releases the sealing ball, allowing the drive spring to open the valve. With the valve open, all water in the washer will drain out.

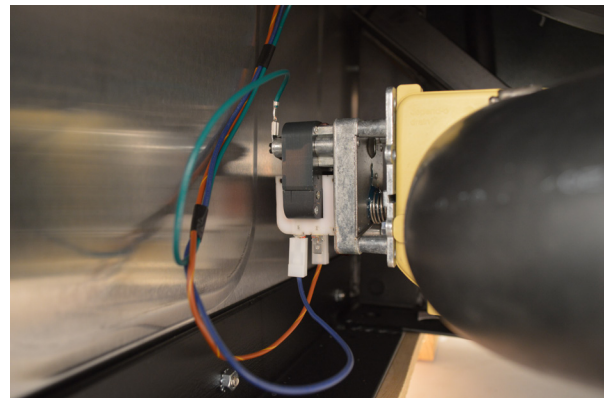

Drain Valve Cleaning

- Step 1:** Loosen the clamp on the tub hose at the drain valve end and remove the hose from the drain valve.
- Step 2:** Loosen the drain hose clamp on the back of the drain valve. Remove two drain valve mounting racket screws from the frame of the washer.
- Step 3:** **Disconnect red & black wire connection at clear connector.**
- Step 4:** Remove the drain valve and bracket assembly. Unplug the wiring after the drain valve is removed from the washer.

Detergent Dispenser (top)

Remove top panel to access dispenser. (see Removing Top Panel)
Detergent is flushed from the front of the compartment and fabric softener is flushed from the back. There will be a small amount of water left in the fabric softener compartment after each use.

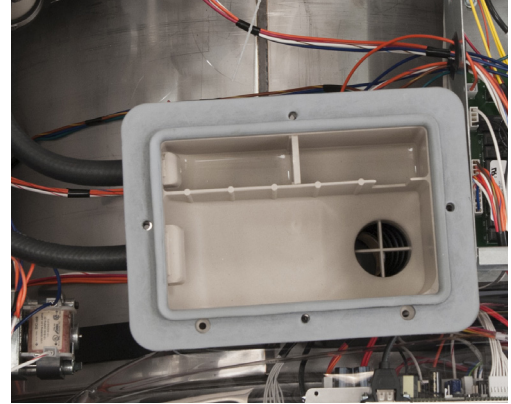

Front Soap Box removal

- Step 1:** Remove front Panel
- Step 2:** Remove the six 3/8 nuts and remove Soap Box mounting bracket and Soap Box, followed by removing gasket.
- Step 3:** Reassemble reverse operation.

Note: Be sure to note position of washers and spacers behind mounting bracket.

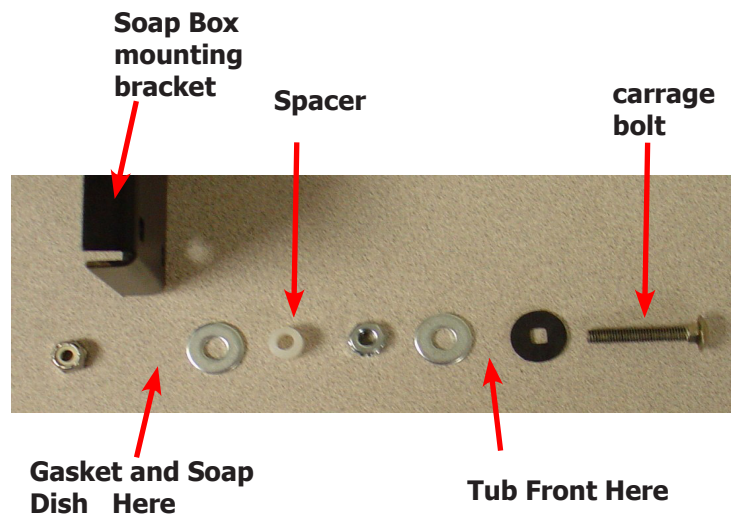

Vacuum Breaker (also called an air gap)

In the left rear of the cabinet is the vacuum breaker. It guides the water to the tub and dispenser and prevents a back flow of water.

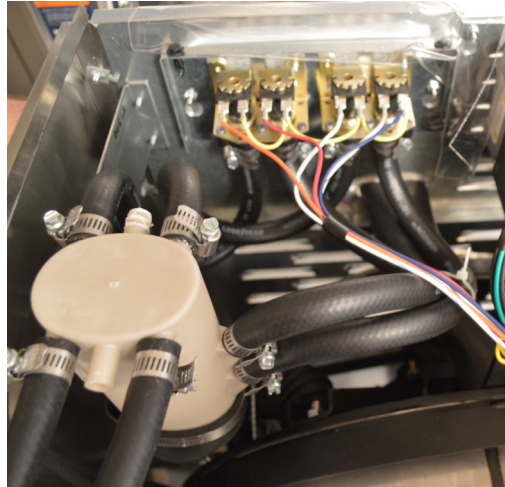

Water Valves

Remove top panel to access water valves. (see Removing Top Panel) The two dual outlet water valves are mounted to the water valve mounting plate that is fastened to the rear channel. To remove the valves, loosen the 2 locking nuts on both sides of the mounting plate from the interior of the machine and then lift the plate and valves off of the back channel and pull the assembly into the machine. The valves can then be removed from the mounting plate by removing the 5/16 mounting screws.

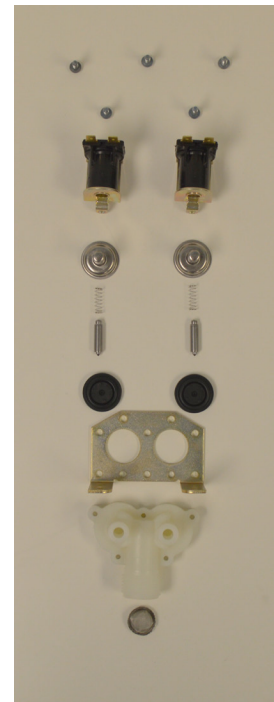

Always check inlet screens to be sure that they are clean. Disassembly requires the removal of two solenoid screws and three valve body screws. Below the solenoid coil is a solenoid guide, armature, armature spring and diaphragm. All valve parts are available individually or as a complete unit.

Door Lock Assembly Operation

After loading the clothing, the door should be closed and latched. The locking cam on the door contacts the latching switch actuator which closes the latching switch. The specified number of coins should now be added to start the washer. The solenoid pulls up on the locking pawl by use of a linkage rod. The locking pawl has two jobs. The first is to lock the door. This is accomplished by blocking the locking cam on the door so that it can't rotate to unlock. The second job is to close the two piggyback lock sensing switches. These switches control power to all of the controls. If the door unlocks for any reason, these two switches will stop the machine. When the door handle is 1/4 to 1/2 of an inch from its fully closed position, the latching switch should close. The two piggyback lock sensing switches should be open when the door is unlocked and should be closed when the door is locked.

Accessing the Door Lock Assembly

After removing the front panel and masking ring, the door lock assembly can now be accessed.

Adjustment for Door Lock Assembly

The latching switch and the piggyback lock sensing switches all have slotted mounting for easy adjustment.

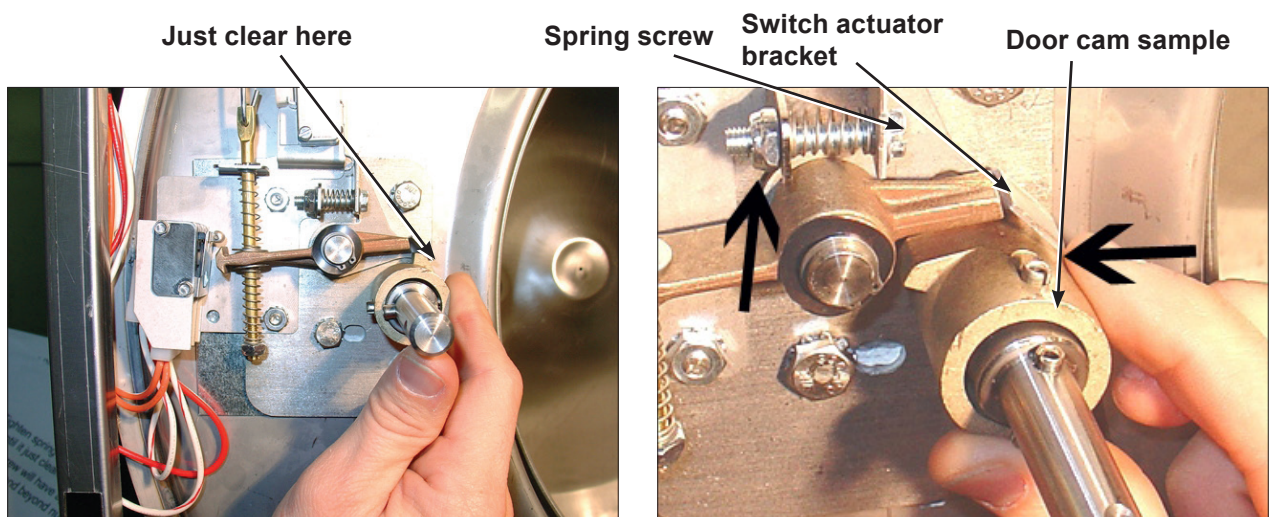

Step 2: Tighten spring screw on switch actuator bracket arm until it just clears cam OD. at base of door lock assembly.

Adjustment to this bracket usually is not necessary as next step is used more in field.

Flat blade screw on door switch latching

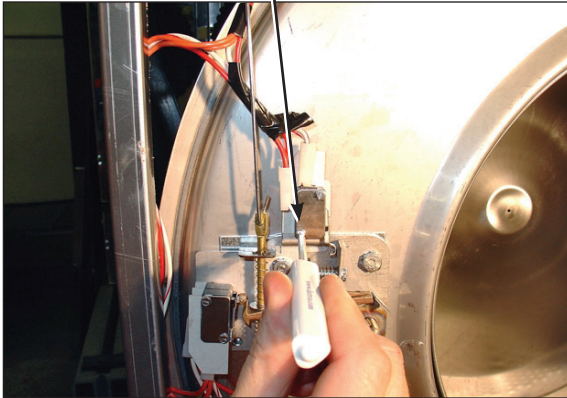

Step 3: With switch actuator bracket adjusted you will now need to adjust single switch by loosening 2 flat blade screws and allowing swivel of switch. Move switch towards above bracket until it actuates. Now tighten flat blade screws. Use a .040 thickness gauge to insert between bracket and switch and the switch should close and open again upon removal of thickness gauge.

Door cam check position

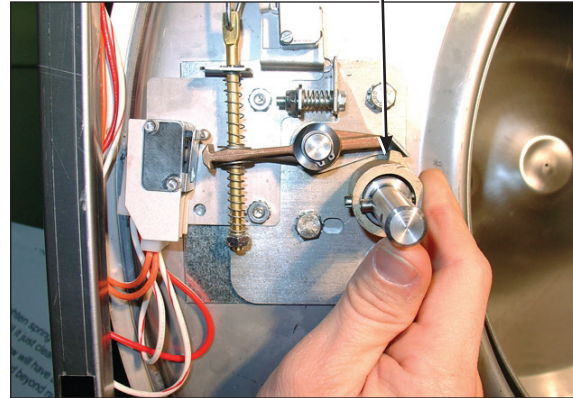

Step 4: Check for switch actuation at partial turn of cam as in operation above. Door handle goes from horizontal to six o'clock vertical.

Door lock rod Locking pawl blocking

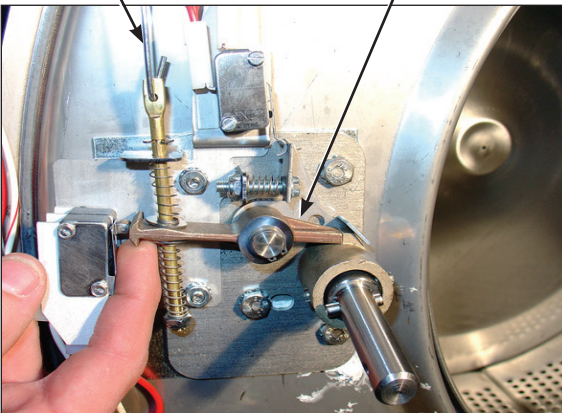

Step 5: Check that lock pawl arm swings to cam lobe to lock position.

Adjustment screw for (piggyback switches)

Top flat end of locking pawl.

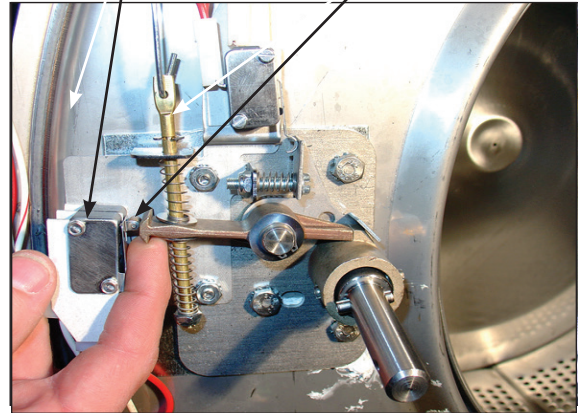

Step 6: The lock stacked switches (piggyback) must be adjusted as door lock solenoid pulls up on door rod and locking pawl is now blocking door cam from turning and is in full up position. The stacked switches (piggyback) have a single actuator arm and it must actuate when single actuator roller wheel rolls to flat side of locking pawl. You will also notice a .040 gap between actuator arm and switch bodies.

Note: Both stacked switches must operate together!

Adjusting the Loading Door

The door can be adjusted by changing the number of shims behind the door hinge and the door lock assembly. The vertical fit of the door to the tub can be altered by loosening the door hinge bolts and raising or lowering the door before retightening. It is important for the door to be centered on the tub front. By chalking the front of the tub and closing the door to transfer that line to the gasket, the centering can be evaluated. It is also important for door pressure to be similar around the door perimeter. Door pressure can be evaluated by inserting a dollar bill in several positions and tugging on it. See Parts Section for kit to increase door sealing pressure.

Loading Door Removal



Step 1: Support door to prevent dropping.



Step 2: Remove the bottom 2 bolts holding the lower leaf hinge and then remove it. The door can now be lifted from the upper post of the hinge assembly.

Loading Door Hinge Removal

Step 1: First remove loading door and front panel.



Step 2: Remove 3 screws holding door hinge. Shims may be present between hinge and tub front. The number may be increased or decreased to adjust right side door pressure.

NOTE:
Door hinge mounting bolts penetrate tub front and require silicone sealer applied to holes when reinstalling.

Loading Door Disassembly

Step 1: Remove the loading door as outlined above. Lay the door on a flat surface with the glass down

Step 2: While holding down on the door glass, lift up on the door ring and roll back the lip of the gasket with your fingers.

Step 3: Work all the way around the gasket and the glass is out.

Loading Door Reassembly

Step 1: Lay the door ring face down on a flat surface. Start the glass into one side of the door gasket.

Step 2: Use one hand underneath to push the gasket out and the other hand on the top pulling the gasket in place

Step 3: The front lip of the door gasket should be checked for proper seating.

Control Panel Name Plate Decal

The name plate on washer front is adhesive backed.

Control Panel Name Plate Removal

The name plate may be removed by simply peeling it off.



Re-Installation of Name Plate

Step 1: Remove any remaining glue from the control panel.

Step 2: Before removing the paper backing from the name plate, check fit to the control panel. The program push buttons are the locating guides.

Step 3: Remove the paper backing from the right side of the name plate, position it on the panel and press right end into place. Peel the backing from the left end and press into place.

Outer Cabinet Removal

T-300, T350, T-400, T450, T-600

Removal of Cabinet T750, T-950, T-950, T-1200, T-1450

- Step 1:** The power supply, water hoses, and drain connection must all be disconnected before proceeding with the disassembly.
- Step 2:** Now remove the lower service panel and the top panel assembly.
- Step 3:** Remove the left and right lower front panel screws that retain the panel to the chassis.
- Step 3:** Remove the bottom row of back panel screws.
- Step 4:** Remove the loading door.
- Step 5:** Remove the four 7/16 nuts along the bottom of each side panel straps. When reinstalling these screws do not overtighten.
- Step 6:** Disconnect the door lock wires from all switches and the door lock solenoid.
- Step 7:** Disconnect pull rod between solenoid and door lock assembly. Disconnect the wires to the dump valve at the bottom of the machine.
- Step 8:** Disconnect the wires to the drive motor from the VFD T1, T2, T3.
- Step 9:** Remove the clamp and the hose from the vacuum breaker where it connects to the inlet on the back of the tub.
- Step 10:** Remove the pressure switch hose from the bottom of the switch.
- Step 11:** It should now be possible for two people to lift the cabinet up and off of the front of the machine and set it aside.

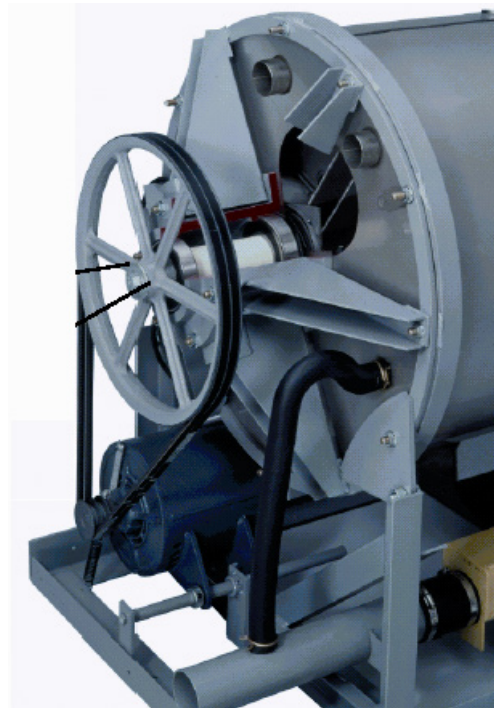

Door Locking Gear Motor Assembly

The door locking gear motor is rotated shut with control voltage to lock the door and releases when voltage is removed. It is located in the left front corner of the washer. (Original locking solenoid models can be converted to the new assembly)

Thermoactuators

The thermoactuators are a safety device that keeps the door from immediately unlocking if power is lost while the machine is operating. They are mounted under the door locking solenoid.

Lock Thermoactuator

Control voltage is applied to the lock thermoactuator at the beginning of the cycle making it extend and block the door locking gear motor. This keeps the door locked for approximately two minutes after a power failure occurs. The lock thermoactuator does not delay the door opening at the end of a normal cycle.

Unlock Thermoactuator

To insure that the lock thermoactuator has retracted by the end of the cycle, one minute prior to the end of the cycle, the unlock thermoactuator is powered with control voltage making it extend and unblock the door locking gear motor.

Drive Belt Removal

Turn the drive pulley while applying pressure to the drive belt until it rolls off of the basket pulley first and then remove from the motor pulley. Be cautious not to drop the motor which could unhook the tension assembly.

Reverse this procedure for installation.

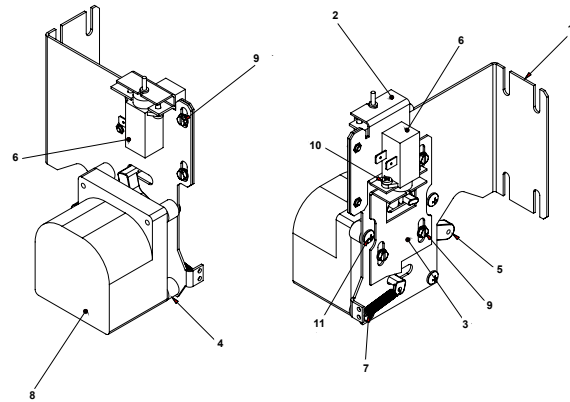

Door Lock Gear Motor

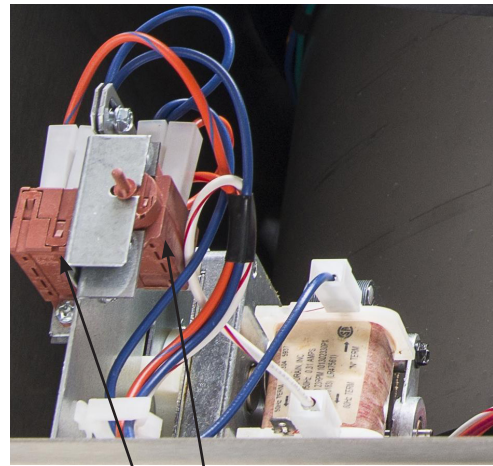

Thermoactuators



Drive Belt

Cylinder (basket)

- Step 1:** Remove the top panel as described previously.
- Step 2:** Remove lower service panel as described previously.
- Step 3:** Remove front panel as described previously.
- Step 4:** Remove masking ring as described previously.
- Step 5:** Remove door lock assembly. (Leave wires & pull rod in place)
- Step 6:** Remove clothes door.
- Step 7:** Remove tub front clamp ring.
- Step 8:** Remove tub front. Use a flat screw driver to pry the tub front loose.
- Step 9:** Remove the rear access panel.
- Step 10:** Remove the drive belts.
- Step 11:** Remove drive pulley. Remove 3 retaining screws. Insert (3) 3/8 16 x 2" screws into the threaded removal holes. Alternately tighten these screws evenly to pull the pulley off.
- Step 12:** Remove pulley hub. Drive a flat screw driver into the slot in the hub and pull it from the shaft.
- Step 13:** Install cylinder puller. (Snap On part #CJ-84-C) Be sure to thread a 5/8-11 NC bolt into the end of the cylinder shaft to protect the threads. Push the basket out.

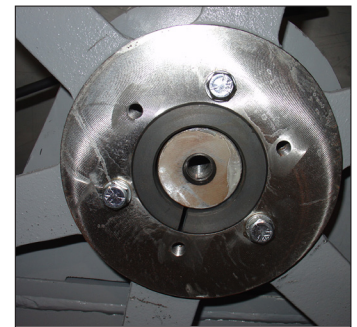
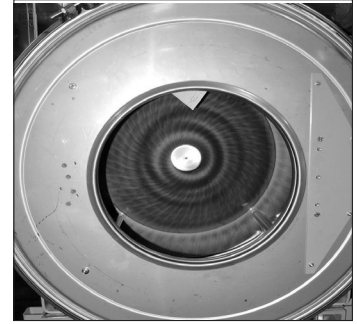

Bearing Housing Assembly

Removal

- Step 1: Remove cylinder from washer (see Cylinder (basket) removal).
- Step 2: Remove 6 7/16" tub back to bearing housing cap screws.
- Step 3: Remove 6 3/4" bearing housing to frame bolts.
- Step 4: Remove bearing housing from frame.
- Step 5: Remove the retaining ring next to the front bearing.
- Step 6: The bearings are pressed into the housing and must be pressed back out.

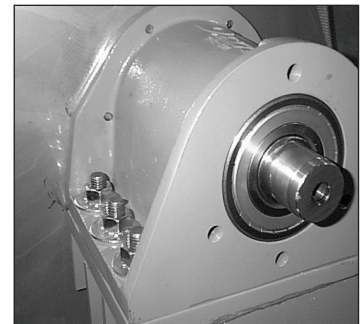

Reassembly

- Step 1: When installing new bearings into a bearing housing, first press the front (large) bearing into the housing until it bottoms and install the snap ring. With the bearing spacer in place, press the rear bearing in until the spacer is snug between the two bearings.

NOTE: If the tub-back water-seal mating ring has been moved it must be cleaned and resealed

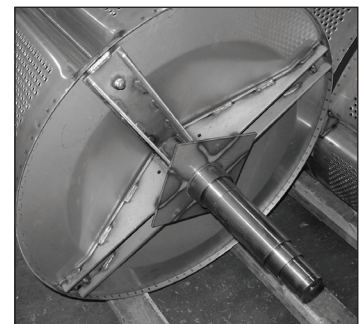

Water Seals

Replacement

- Step 1:** Remove cylinder from washer (see Cylinder (basket) removal).
- Step 2:** Remove water seals from the seal mounting plate on the cylinder shaft. These are removed with your fingers.
- Step 3:** The primary and secondary seals that mount on the sealing ring may be slid over the shaft and seated on the metal sealing ring with your fingers. In the unlikely event that the metal ring that mounts these sealing rings were to be damaged or moved, a new one would need to be pressed on. The seal mounting ring must be pushed against the stop on the shaft. After installing the seals, lubricate the faces of the seals with silicone grease.
- Step 4:** Install cylinder (see Cylinder (basket) reassembly).

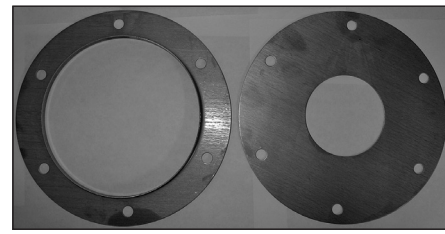

Guard Ring & Mating Ring

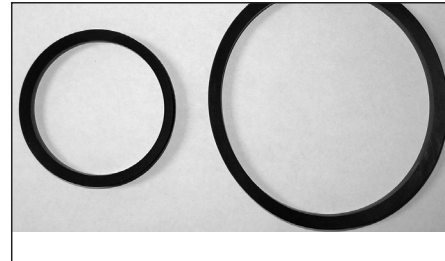

Seals

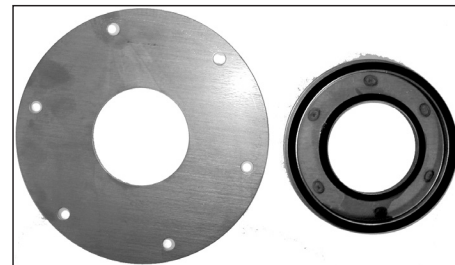

Mating Ring & Mounting Ring

Outer Tub

Removal

- Step 1:** The outer tub can easily be removed when the tub front, cylinder and bearing housing has been removed as outlined previously.
- Step 2:** At that point the only attachments to the chassis are the two front strap mounting bolts.

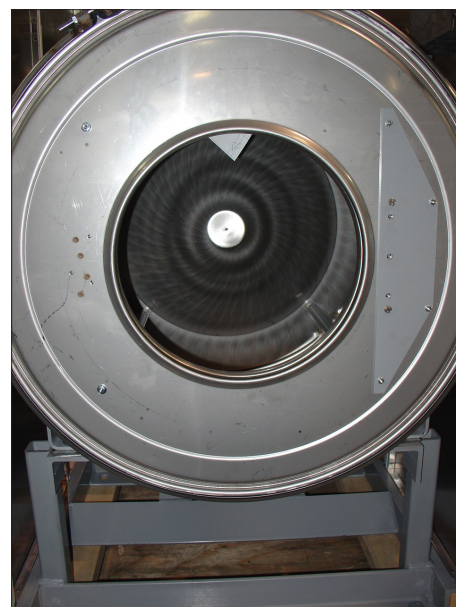

Reassembly of the Cylinder

- Step 1:** Use the hub of the drive pulley, a stack of 5/8" flat washers and a 3" long 5/8" bolt to pull the cylinder shaft through the bearings. After the 3" bolt a 2" long bolt will be required to finish pulling the cylinder shaft through.
- Step 2:** Remove the 1/2" bolt and nut from the top of the outer tub clamping band.
- Step 3:** Install Dexter Tool part # 8545-056-001 on the back of the outer tub to adjust tub front to cylinder clearance. Thread 5/8" bolt through tool and into cylinder shaft. Push the outer tub forward 1/4" to 1/2" with tool 8545-056-001 by tightening the 5/8" bolt. This will ease the installation of the outer tub front.
- Step 4:** Clean the silicone rubber off the tub front and the outer tub.
- Step 5:** Install new bead of silicone rubber on tub front.
- Step 6:** Install tub front.
- Step 6A:** Align hole in top of tub front with notch in top of outer tub.
- Step 6B:** Use 4-6 #11R vise grip clamps to hold tub front to outer tub. A rubber mallet may be needed to properly seat the tub front into the outer tub.
- Step 6C:** Install tub front gasket around outer edge of tub front and outer tub flange. The opening should be centered at the top.
- Step 6D:** Remove vise grips. The tub front gasket will hold the tub front in place.
- Step 7:** Install tub front clamp ring and tighten. Tap around the clamp ring with a rubber mallet to seat the ring and gasket while tightening the clamp ring bolt.
- Step 8:** Adjust clearance between the outer tub front and the front lip of the cylinder to 5/16".
- Step 9:** Tighten the outer tub clamping band.
- Step 10:** If necessary, the outer tub may be adjusted up or down and side to side with the 2 bolts that fasten the bottom of the outer tub clamping band to the frame.
- Step 11:** Remove Dexter Tool part 8545-056-001 from the back of the outer tub.
- Step 12:** Install drive pulley.
- Step 12A:** Install hub on cylinder shaft.
- Step 12B:** Hold hub against rear bearing with 5/8" bolt and flat washer in end of cylinder shaft.
- Step 12C:** Line up 3 unthreaded holes in pulley with the 3 threaded holes in hub.
- Step 12D:** Insert 3 pulley bolts and tighten evenly alternating bolts to 30ft/lbs.
- NOTE:** Overtightening or uneven tightening can break drive pulley.
- Step 13:** Install drive belts & back panel.
- Step 14:** Install door lock. All mounting holes should be sealed with silicone rubber.
- Step 15:** Install door, masking ring, front panel, lower service panel and top.

T-750 Bolt Torque Chart

Bolt Size	Where Used	Torque
1/2"x 1 1/4" bolt	Tub End of Bearing Hsing. 9545-017-009	70-110 ft/lbs
5/8"x 1 1/2" bolt	Tub End of Bearing Hsing. 9545-060-001	120-150 ft/lbs
1/2"x 1 1/4" bolt	Mtg. of Tub to Cradle Asy. 9545-017-009	70-110 ft/lbs
5/8"x 2 1/2" bolt	Mtg. of Tub to Cradle Asy. 9545-060-001	120-150 ft/lbs
3/8"x 1 1/2" bolt	Tub Back Ring to Tub Back 9545-029-003	45-80 ft/lbs

T-950 Bolt Torque Chart

Bolt Size	Where Used	Torque
7/16" Stainless Cap Screw	Outer Tub to Bearing Housing	60-80 ft/lbs
3/4" Bolt	Bearing Housing to Frame	200-300 ft/lbs
1/2" Bolt	Outer Tub Clamping Band to Frame	70-110 ft/lbs
1/2" Bolt	Outer Tub Clamping Band - Top	30-40 ft/lbs
3/8" Cap Bolt	Driven Pulley to Hub	28-32 ft/lbs

T-1450 Bolt Torque Chart

Bolt Size	Where Used	Torque
7/16" Stainless Cap Screw	Outer Tub to Bearing Housing	60-80 ft/lbs
7/8" Bolt	Bearing Housing to Frame	600-650 ft/lbs
1/2" Bolt	Outer Tub Clamping Ears to Frame	70-110 ft/lbs
3/8" Cap Bolt	Driven Pulley to Hub	28-32 ft/lbs

Section 6:

Service Electrical Components

Control Mounting Trough

Remove top panel to access control trough. (see Removing Top Panel) It sets on the right side of the machine and holds the control PCB's, transformers, and pressure switch.

Main Data Communication Cable

Goes between front PCB board and Variable Frequency Drive unit mounted center rear of machine. It has telephone type connectors at each end and is inserted at Controller PCB and the Variable Frequency Drive.

Circuit Breaker/Fuse

The fuse (optional circuit breaker) mounts to the rear channel. It carries all of the controls in the machine but does not include the motor. To reset the circuit breaker just push in the button. If you have a fuse then remove fuseholder and fuse and replace with a 1 1/2 amp fast blow type fuse.



Fuse Location

Main Control Printed Circuit Board

Please be sure to be grounded to machine before removal of this board from machine. PC board mounted vertically behind front control panel. Remove hold down nuts in 4 corners and 1 at bottom center.

PCB Transformer Step-down

Small transformer mounted at front of control trough that is powered with 120 VAC primary and two secondary outputs of 2.3 VAC and 24-27 VAC.

Controls Transformer

This transformer is mounted at the back of the control trough and steps a range of 208 to 240 volts down to 120 volts for the controls. There are two terminals on the controls transformer for incoming power. One terminal tap is marked for 208 volts use this tap for measured voltage of 200 volts - 215 volts. and the other tap is marked 230 volts for 216 volts - 240 volts. Note: All washers have a controls transformer. Always check the incoming voltage and use the appropriate transformer terminal when installing ALL washers.

Main Relay Printed Circuit Board

Please be sure to be grounded to machine before removal of this board. PCB mounting horizontal in control trough towards front of machine. Remove 4 mounting nuts.

LED Printed Circuit Board Temperature & Start Display/Push-Button

The selector switch is mounted in the center of the control panel and is held in place with five nuts. It allows the selection of hot, warm or cold water temperatures. Note: Do not over tighten on reinstallation as the switch can be damaged, stay pushed in and will cause erratic displays.

Emergency Stop Button Switch Assembly

The stop button is mounted on right side of machine. Remove the top and access the rear of button. Remove the plastic retainer by unthreading CCW. The switch assembly will have to be removed by pressing down on the plastic clip while pulling the switch body away from the stop button.



Temperature and Start Display

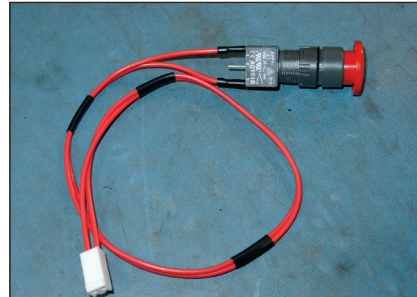

Stop Button Switch Assembly

Pressure Switch Caution (Not recommended by Factory!)

Changing Factory preset adjustment voids all factory water usage specifications.

The pressure switch sets the water level in the washer. As the water level rises, it compresses the air in the pressure switch hose. When the washer reaches the desired water level, the compressed air in the pressure switch hose opens the contacts in the switch, shutting off the water. When at the empty level, the pressure switch contacts are closed allowing the machine to either spin or fill with water. The 1/4" screw in the middle of the switch adjusts the water level. Counter clockwise will lower the water level, and clockwise will increase the water level on the single level switch. The dual level switch can be adjusted by turning the torx screws as shown. Before making any adjustments of the pressure switch, drain the tub and blow the hose clear of possible water bubbles which can cause erratic pressure switch operation.

SINGLE LEVEL

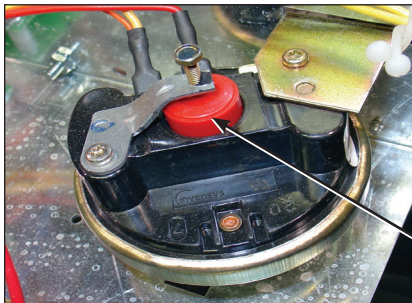

Pressure Switch

DUAL LEVEL

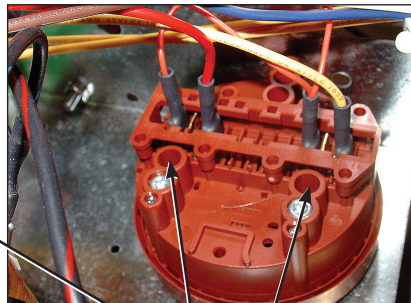

Adjustment

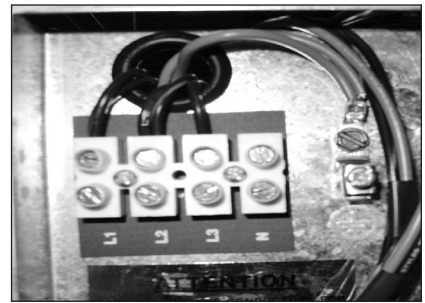

Rear

Electronic Pressure Sensor

The Electronic Pressure Sensor comes standard on all models Starting Septembet, 1st 2015. Machines manufactured before this date can be upgraded with Kit 9732-213-001. The Pressure sensor is adjustable. The Factory settings chart will let you know the starting values for each machine and by following the Switch position chart you can adjust the water levels in 1/4 inch increments from that starting value.

Factory Settings:



Model	Vended		On-Premise	
	Switch #1 Efficient	Switch #2 Classic	Switch #1 Low Level	Switch #2 High Level
T-300	5.25	7.00	6.00	6.75
T-350	5.25	6.25	6.00	6.75
T-400	7.00	9.00	8.00	11.00
T-450	6.00	6.25	6.00	8.50
T-450 SWD	5.00	7.00	6.00	8.50
T-600	7.25	9.25	8.00	11.00
T-650	6.50	8.25	8.00	11.00
T-750	6.00	7.50	6.00	8.75
T-900	6.00	7.50	6.00	8.75
T-950	6.00	7.50	6.00	8.75
T-1200	6.00	7.50	6.00	8.75
T-1450	6.75	7.00	6.75	9.50

Switch Positions:

Depth (in):	Pos 1	Pos 2	Pos 3	Pos 4	Pos 5	Pos 6
5.00						
5.25	on					
5.50		on				
5.75	on	on				
6.00			on			
6.25	on		on			
6.50		on	on			
6.75	on	on	on			
7.00				on		
7.25	on			on		
7.50		on		on		
7.75	on	on		on		
8.00			on	on		
8.25	on		on	on		
8.50		on	on	on		
8.75	on	on	on	on		
9.00					on	
9.25	on				on	
9.50		on			on	
9.75	on	on			on	
10.00			on		on	
10.25	on		on		on	
10.50		on	on		on	
10.75	on	on	on		on	
11.00				on	on	
11.25	on			on	on	
11.50		on		on	on	
11.75	on	on		on	on	
12.00			on	on	on	
12.25	on		on	on	on	
12.50		on	on	on	on	
12.75	on	on	on	on	on	
13.00						on
13.25	on					on
13.50		on				on
13.75	on	on				on
14.00			on			on
14.25	on		on			on
14.50		on	on			on
14.75	on	on	on			on
15.00				on		on

Power Connection Terminal Block

This terminal block sets at the very back of the control trough. Incoming power to the washer should connect here. (see Electrical under Installation and Operation Section for exact connections)

Delta Variable Frequency Drive:

Main power is connected to terminals L1, L2, and L3 on the Delta drive. If the washer is connected to a three phase source, there should be voltage present on all three terminals. If the washer is connected to single phase power, there should be voltage present on terminals.

The voltage should measure 208 Volts to 240 Volts A.C. between phases and connected to if connected to three phase). There is a tolerance of + 10% on the mains voltage (187 Volts to 264 Volts).

Delta VFD Motor Leads:

The wires from the motor are connected to terminals T1, T2, and T3. Since this drive uses pulse width modulation, an accurate current or voltage reading is not possible. Although an accurate current reading is not possible, a balanced current reading should be present while the motor is running.

Delta VFD Dynamic Braking Resistors:

Two, 160 Ohm or 200 Ohm braking resistors (Please check your washer model parts requirements and quantities), are connected in parallel and attached to the drive at terminals B1 and B2. These resistors allow voltage, which is generated by the motor when decelerating, to be dissipated. They will become hot while the motor is slowing down, so care should be taken so as not to come in contact with them. This will prevent an electrical shock and/or a physical burn.

Delta VFD Cooling Fan:

There is a cooling fan attached to the bottom of the Delta drive. This fan will operate when the internal temperature of the drive reaches a predetermined level, the same way the radiator fan in a newer car operates. **THE FAN CAN OPERATE ANYTIME POWER IS APPLIED TO THE DRIVE!** Remove power to the drive if work is required around the fan.

Section 7:

Electrical Wiring Diagrams & Schematics

Electrical Path Circuit Schematics

Start Circuit

Power travels into the machine on L1 & L2 & (L3, if 3 phase used). L1 and L2 provide 208- 240VAC to the controls transformer which steps the voltage down to 120VAC for the controls. (The L1 connection at the controls transformer must be checked at start-up to coincide with machine operating voltage) The 120VAC travels out from the transformer on either [X-1 red wire directly to the 1.5 amp fuse] or [X-1 black/red wire to TB-4 and then through the red wire to the 1.5 amp fuse]. The controls transformer also creates a neutral on the X-2 black/blue wire that connects to TB-1. From the fuse holder, 120VAC travels on the red wire to the #6 terminal on the terminal strip and then through the black wire to another step-down transformer. From the terminal strip the blue wire will provide the neutral for solenoid, thermoactuators and all valves. The white wire provides the neutral from the terminal to the step down transformer.

120VAC is stepped down to 24 VAC (blue wires), 24VAC (red wires), and a yellow center tap wire to the P-7 power connection on the main controller PCB . With the main control PCB now powered, 5VDC will be present between the (2) yellow wires and also the (2) brown wires for the coin switches. Both pairs will now be ready to count coins through the P-2 connection at the control PCB. 26.8 VAC goes out on the black wire of the P-4 connection from the main control PCB to the S5 door closed switch which mounted on the hinge side of the front panel. Closing the door will engage the door closed switches, sending the voltage to the red wire on the S1 door latched switch. Turning the door handle to the vertical latched position closes the S1 door latched switch, returning the voltage to the main control PCB on the white/red wire at the P-4 connection. 26.8VAC is now present at the S2 and S3 door locked switches.

26.8VDC is also at the black and white wires between P-21 at the main control PCB and the P-20 of the relay PCB. This voltage signals the relay PCB that the door is closed and latched making 120VAC available to the relays controlling the door lock gear motor assembly, drain valve and water valves. A continuous 5VDC is sent on the red wire from the P-1 connector on the main control PCB, through the (normally closed) emergency stop button switch and returns on the second red wire back to the P-1 connector. After selecting the temperature, payment is added and the display counts down on the main control PCB display until the vend price is satisfied. The display will change to scroll PUSH START and the green light over the start button will flash. Pressing the start button on the front of the main control PCB signals the relay PCB to lock the door and 120VAC will go to the door lock gear motor on the white/red wire from the P17 connector of the relay PCB. The door lock gear motor engages and pulls up on the door locking rod, locking the door and closing the S2 and S3 door locking switches.

The S2 locking switch is a backup to the S1 latching switch so that once the cycle starts the S1 isn't critical. The S3 locking switch provides 26.8VDC on the orange wire back to P4 connector at the main control PCB and the P15 connector at the relay PCB. This signals that the loading door is closed,locked and safe to continue wash operations. This activates the P-13 and P-14 yellow enable wires to the inverter drive to allow motion. If there is no signal on P-15 (orange wire) their will be no motion of the tub. S1, S2, S3 and S5 door switches are now closed . The green "On" LED and the door lock solenoid (discussed in start circuit) will remain on throughout the cycle.

Fill Circuit-Warm

The relay PCB supplies 120VAC to the brown/yellow wire from P-17 to the drain valve which closes the valve. The lock thermoactuator also receives 120VAC on orange/blue from P17 of the relay PCB. This device prevents the door lock solenoid from dropping out and unlocking during the cycle in the event of a power loss. The 120VAC will cycle on and off keeping the lock thermoactuator engaged until 70 seconds before the end of the cycle. The main control PCB sends data commands to the VFD through the data cable connected at P-6. These commands control the wash basket which will tumble one direction for 12 seconds, pause, and then reverse direction for 12 seconds.

The prewash or wash LED will illuminate at this time, powered through the white wires from the P-3 connection of the main control PCB to the LED printed circuit board. Using the factory preset cycle as an example: The washer fills the tub through the back of the machine with either one or both the C1 cold and H1 hot water valves. From the P19 connection of main relay PCB, 120VAC is sent out on the white/brown wire to the C1 cold water fill valve and the red/yellow wire to the H1 hot water fill valve depending on the temperature selected. After a 90 second delay from the beginning of the wash cycle bath only, the detergent dispenser flushes the detergent into the tub for 20 seconds. This is accomplished when 120VAC travels through the red/orange wire to the H2 hot water valve solenoid. During the machine fill, a 5VDC signal is sent on the red wire from the P5 connection of the main control PCB to the pressure switch contact and returns on the yellow and orange wires to the P5 connection of the main control PCB. When the water level in the basket reaches the preset level pressure, the switch moves the switch contacts to the full or open position. This causes the main control PCB to signal the relay PCB to shut off the water valve coils.

Wash Circuit

Once the machine has achieved it's water level, the wash basket will continue to tumble one direction for 12 seconds, pause, and then reverse direction for 12 seconds. The time on the front display will count down as the bath progresses. The time of the bath is programmable up 15 minutes per bath. Note: When programming cycles, the wash bath must be programmed for 3 minutes or more.

Drain

When the program bath time ends the main control PCB signals the relay PCB to remove 120 VAC power from brown/yellow wire at P17 going to the drain valve. The normally-open, spring-loaded drain valve opens allowing water to exit the machine. This resets the pressure switch back to an empty level and restores the 5VDC connection through the pressure switch from the red wires to the orange and yellow wires.

Rinse 1 & 2

For Rinse 1 & 2, the rinse LED will illuminate, the drain valve will receive 120VAC and close. The basket will fill and tumble the same as the wash bath for the programmed time. The rinse water temperatures are programmable and factory default is cold.

Final Rinse Circuit

The final rinse LED will illuminate, the drain valve will receive 120VAC and close. The basket will fill and tumble the same as the previous baths for the programmed time. The final rinse water temperatures are programmable. Note: When programming cycles, the final rinse bath must be programmed and cannot be set for less than 3 minutes. Also at the beginning of the final rinse bath, the main control PCB will signal the relay PCB to send 120V to the P-19 connector on the white/blue wire to the C2 cold water valve for 20 seconds to flush the fabric softener dispenser.

Spin Circuit

The spin LED will illuminate and the main control PCB sends a signal to the variable frequency drive via the data cable at P6 to VFD RJ-11. The rotation as viewed from front during spin will be counter-clockwise. (The 18lb washers will extract in a clockwise direction) The time of the spin cycle can be programmed. Note: The final spin must be programmed into the final rinse bath and must be programmed for 1 minute or more.

Unlock Thermoactuator and Shake Out Circuit

70 seconds before the end of the cycle the main control PCB signals the relay PCB to remove 120VAC from the orange/blue wire at the P-17 connector on the lock thermoactuator. This allows the lock thermoactuator time to cool and retract by the end of the cycle. To insure that the lock thermoactuator has retracted by the end of the cycle, 1 minute prior the end of the cycle, the unlock thermoactuator is powered with 120VAC through the orange/red wire from the P-17 connector of relay PCB. The unlock thermoactuator moves the complete bracket assembly away from the white door lock actuator allowing it to drop at the end of the cycle, unlocking the door. The basket will come to a stop from spin speed with the assistance of dynamic braking resistors wired to the variable frequency drive. (See wiring diagrams for quantities and resistor ohm values). The washer will then tumble for 45 seconds to let the clothes shake loose from the basket and then stop.

End of Cycle and Door Open Circuit

Once the machine stopped, 3 things occur:

1. The enunciator will signal for 3 seconds letting the user know that it is the end of the cycle.
2. The Display of the Washer will scroll "CYCLE DONE THANK YOU".
3. The main control PCB signals the relay PCB to remove power from the white/red wire at P-17 which allows the door lock solenoid to unlock. When the loading door is opened, the S1,S2,S3,S5 switches are opened. The machine is now ready to accept coins again.

Express: 208-240V Schematic

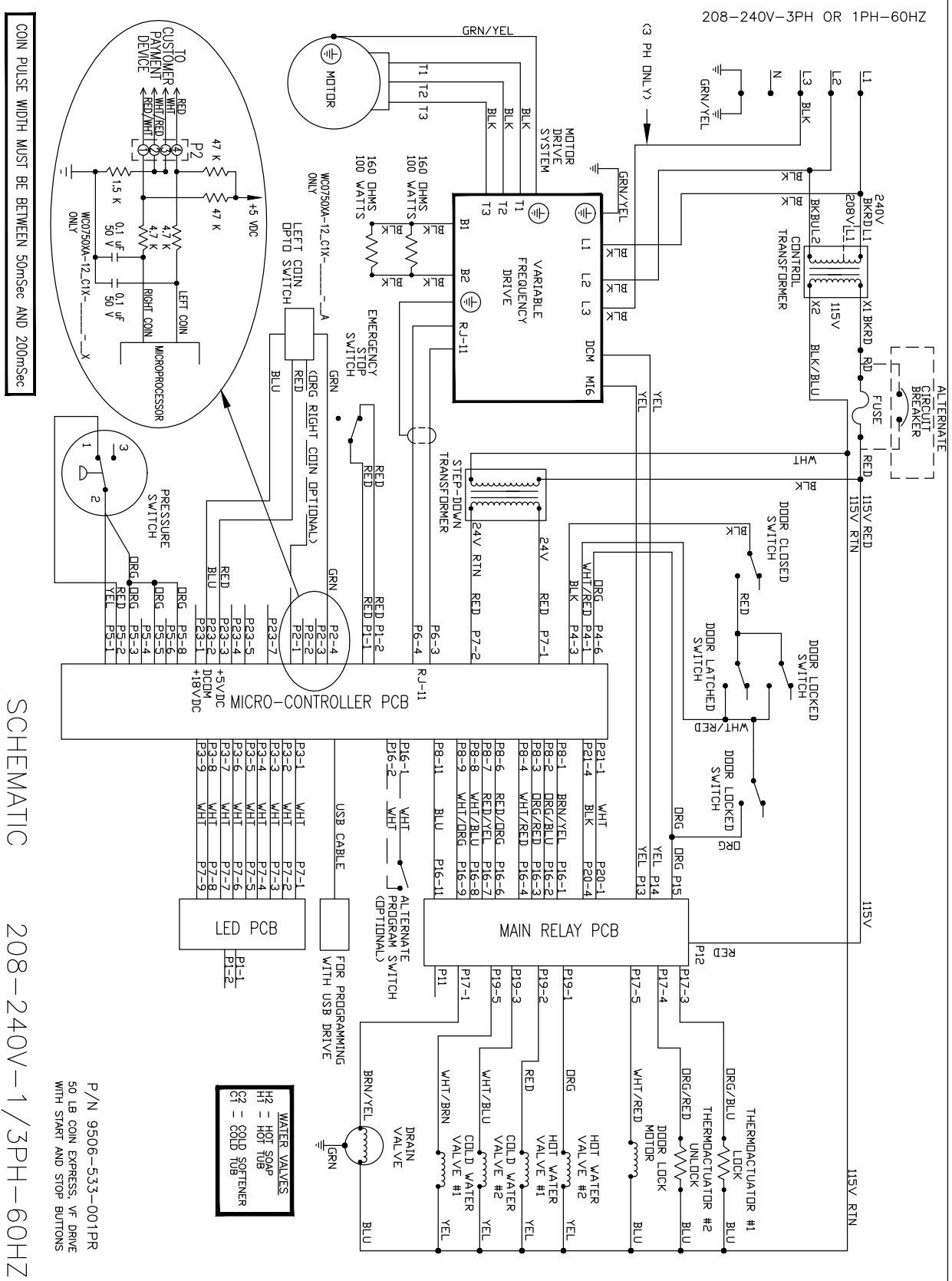

P/N 9506-533-001PR
50 LB COIN EXPRESS, VF DRIVE
WITH START AND STOP BUTTONS

Express: 208-240 Volt Wiring Diagram

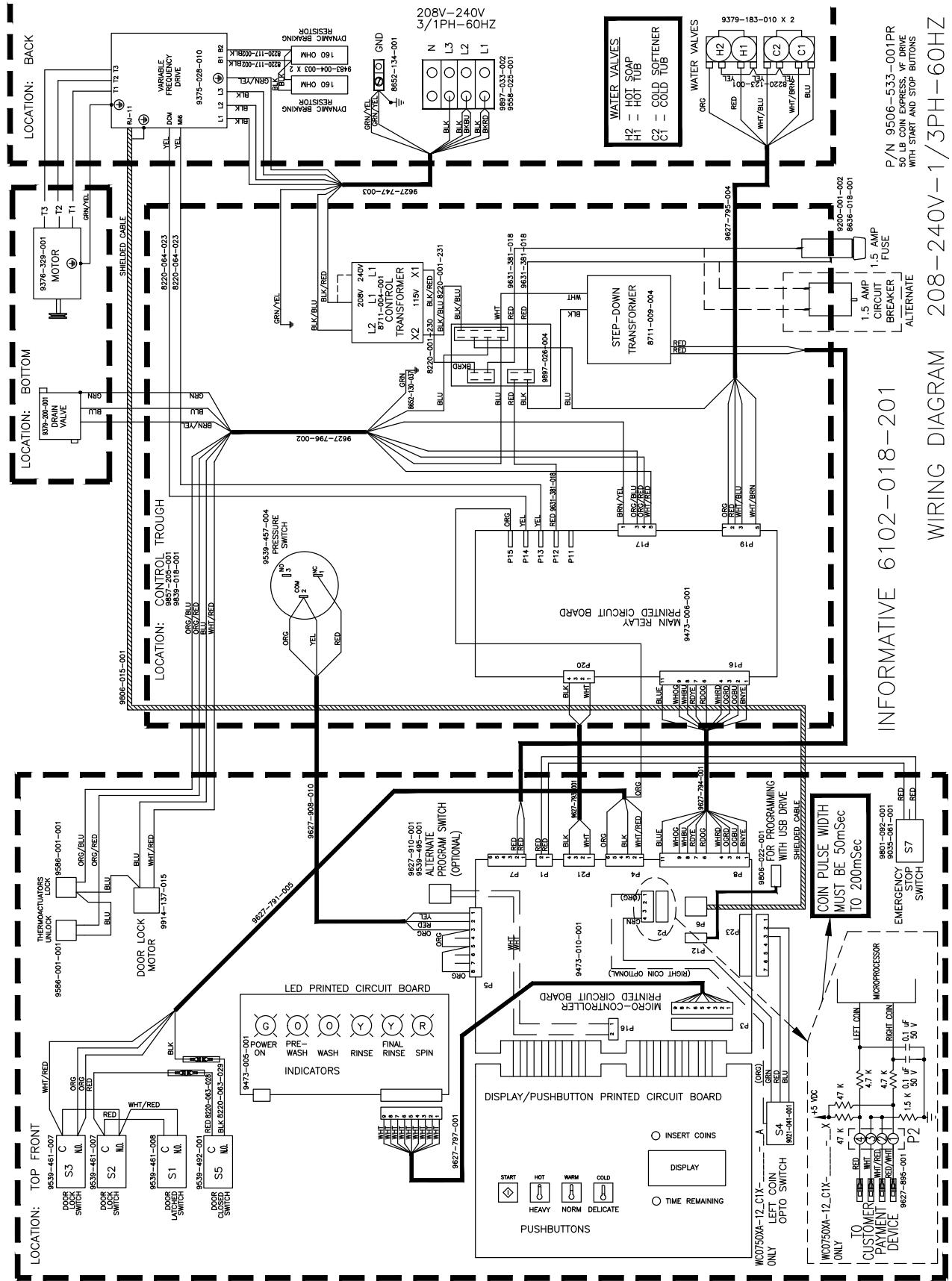



Section 8:

Parts Data

C-Series Vended

Express Large

Chassis

WC0650XA-12EC_X
WC0750XA-12EC_X
WC0950XA-12EC_X
WC1450XA-12EC_X

Before Serial # W1.19227.073
Before Serial # W1.19246.001
Before Serial # W1.19224.012
Before Serial # W1.19200.007

C-Series Accessories

WC0650-XA12ECX	208-240 volts	60hz	Single Phase or Three Phase
WC0750-XA12ECX	208-240 volts	60hz	Single Phase or Three Phase
WC0950-XA12ECX	208-240 volts	60hz.	Single Phase or Three Phase
WC01450-XA12ECX	208-240 volts	60hz	Single Phase or Three Phase

Key	Description	T650	T750	T950	T1450	QTY
*	Hose, Water Supply 3/8" I.D. x 48"	9990-027-011				2
*	Hose, Water Supply 5/8" I.D. x 48"		9990-027-013	9990-027-013		2
	Hose, Water Supply 5/8" I.D. x 48"				9990-027-013	4
*	Washer, Inlet Hose (furnished)	8641-242-000	8641-242-000	8641-242-000	8641-242-000	2
*	Strainer, Inlet Hose (furnished)	9565-003-001	9565-003-001	9565-003-001	9565-003-001	2
*	Bevel Washer for 5/8" bolt used in installations using angle iron bases					
*	Bevel Washer for 3/4" bolt used in installations using angle iron bases	8641-586-003	8641-586-003	8641-586-003	8641-586-003	4
*	Sealing compound	8538-151-001	8538-151-001	8538-151-001	8538-151-001	1
*	TORX#20	8545-051-002	8545-051-002	8545-051-002	8545-051-003	1
*	Special Tool For Removing Coin Acceptor Mounting Screws. (T-10 Torx)	8545-051-003	8545-051-003	8545-051-003	8545-051-003	1
*	Flow Restrictors (in dispenser)	9475-002-002	9475-002-002	9475-002-002	9475-002-002	2
*	Battery (used on Control PCB)	8612-001-001	8612-001-001	8612-001-001	8612-001-001	1
*	Special Tool for adjusting spacing between outer tub front and cylinder front	8545-056-001	8545-056-001	8545-056-001	8545-056-001	1
*	Clamps to hold tub front to outer tub when installing tub front	Vise Grip #11R	Vise Grip #11R	Vise Grip #11R	Vise Grip #11R	1
*	Coin Bearing & Seal Kit		9732-219-006	9732-219-006	9732-219-006	1
*	Key Service Lock (6324)	6292-006-007	6292-006-007	6292-006-007	6292-006-007	1
*	USB, Thumb Drive (Blank)	9150-045-001	9150-045-001	9150-045-001	9150-045-001	1
*	USB, Thumb Drive, W/File	9150-045-002	9150-045-002	9150-045-002	9150-045-002	1
*	Mode Light Support	9635-022-001	9635-022-001	9635-022-001	9635-022-001	1
*	Plastic Plug 1 1/2"-(inside cylinder)	9456-041-007				1

Wiring Harness Part # by Model

Key	Description	T650	T750	T950	T1450	QTY
*	Wiring Harness, Door Lock	9627-791-001	9627-791-005	9627-791-005	9627-791-005	1
*	Wiring Harness,CoinDrop Mech	9627-792-001	9627-792-001	9627-895-001	9627-792-001	1
*	Wiring Harness, Drain,Thermo,DoorSol	9627-796-002	9627-796-002	9627-796-002	9627-796-002	1
*	Data Cable	9806-015-001	9806-015-001	9806-015-001	9806-015-003	1
*	Wiring Harness P20/P21	9627-793-001	9627-793-001	9627-793-001	9627-793-001	1
*	Wiring Harness P8/P16	9627-794-001	9627-794-001	9627-794-001	9627-794-001	1
*	Wiring Harness WaterValve/P19	9627-795-004	9627-795-004	9627-795-004	9627-795-004	1
*	Wiring Harness LED PCB	9627-797-001	9627-797-001	9627-797-001	9627-797-001	1
*	Wiring Harness P5/pressure	9627-908-010	9627-908-010	9627-908-012	9627-908-014	1
*	Wiring Assembly Yel. 32"	8220-064-023	8220-064-023	8220-064-023	8220-064-062	2
*	Wiring Assembly Red 7" #36	9631-381-018	9631-381-018	9631-381-018	9631-381-018	3
*	Wiring Assembly Blk/Blu	8220-001-231	8220-001-231	8220-001-231	8220-001-231	1
*	Wire Assembly BLK. 23" #8	8220-063-029	8220-063-029			
*	Harness Power Terminal Block	9627-747-003	9627-747-003	9627-747-003	9627-747-003	1
*	Wire Yellow Jumper (water valve)			8220-119-002	8220-119-002	1
	Cable Assembly, USB	9806-022-001	9806-022-001	9806-022-001	9806-022-001	1

Cabinet and Front Panel Group Part # by Model

Key	Description	T650	T750	T950	T1450	QTY
1	Panel, Side (Left or Right) - stainless		9454-812-001			2
1	Panel, Side (Left or Right) - stainless	9732-359-001		9732-359-002	9732-359-004	4
*	Strap Assembly (side panel)	9966-012-001	9966-013-001	9966-012-001	9966-012-001	2
*	Shim (side panel)	9552-039-001	9552-041-001	9552-039-001	9552-044-001	2
*	Nut, Hex 1/4-20 UNC (for strap assembly	8640-414-006	8640-414-006			6
*	Nut, Hex 1/4-20 UNC			8640-414-006	8640-414-006	8
2	Bracket, Side Panel under front panel	9046-094-001	9046-085-001	9046-085-001	9046-086-001	1
3	Screw #10Bx1/2 side panel brkt	9545-008-026	9545-008-026			1
4	Nut 1/4-20 UNC side panel brkt	8640-413-002	8640-414-006			1
•	Nut, Hex			8640-414-006	8640-414-006	2
*	Screw			9545-008-026	9545-008-026	2
5	Panel Assy, Front	9454-913-001	9454-810-001	9989-617-002	9989-619-002	1
*	Band, Edge Protector	9578-092-005	9578-092-005	9578-092-005	9578-092-005	1
6	Bumper Loading Door	9051-055-001	9051-055-001	9051-055-001	9051-055-001	1
*	Nut, 1/4 x 20 for bumper	8640-414-003	8640-414-003	8640-414-003	8640-414-003	1
*	Screw, Hex- To Control Panel	9545-008-023	9545-008-026	9545-008-026	9545-008-026	2
*	Nut, Spring- To Control Panel 10/32	8640-442-001	8640-442-001	8640-442-001	8640-442-001	2
7	Screw, Flat Head- Front to Sides	9545-008-014	9545-008-014	9545-008-014		2
7	Screw, Flat Head- Front to Sides				9545-008-014	4
8	Washer, Finish	8641-585-001	8641-585-001	8641-585-001		2
8	Washer, Finish				8641-585-001	4
*	Nut, Spring-To Front Panel	8640-442-001	8640-442-001	8640-442-001	8640-442-001	2
9	Label-Door Opening (Blue	8502-757-002	8502-757-002	8502-757-002	8502-757-002	1
9	Label-Door Opening (Black)	8502-757-001	8502-757-001	8502-757-001	8502-757-001	1
10	Label-Risk of Injury (Blue)	8502-759-002	8502-759-002	8502-759-002	8502-759-002	1
10	Label-Risk of Injury (Black)	8502-759-001	8502-759-001	8502-759-001	8502-759-001	1
11	Panel, Control (Mounts Nameplate)	9989-559-001	9989-560-001	9989-560-001	9989-561-001	1
*	Screw, Control Panel to Sides	9545-008-026	9545-008-026	9545-008-026	9545-008-026	4
12	Nameplate Decal, Control Blue	9412-235-002	9412-213-002	9412-207-002	9412-215-002	1
12	Nameplate Decal, Control Black	9412-235-001	9412-213-001	9412-207-001	9412-215-001	
13	Panel Top	9454-912-002	9454-743-001	9454-736-002		1
14A	Panel Top Front				9454-850-001	1
14B	Panel Top Rear				9454-851-001	1
15	Lock, Top (w/Key)	8650-012-003	8650-012-003	8650-012-003	8650-012-003	2
*	Key, Top- # 6324	6292-006-007	6292-006-007	6292-006-007	6292-006-007	1
*	Lock Spacer	9538-189-001	9538-189-001	9538-189-001	9538-189-001	*
*	Cam, Lock-Top	9095-049-001	9095-049-001	9095-049-001	9095-049-001	1
*	Nut, 9/32 - 28 Hex	8640-426-001	8640-426-001	8640-426-001	8640-426-001	1
*	Washer Flat 5/16	8641-581-008	8641-581-008	8641-581-008	8641-581-008	1
16	Door, Lower Service, Includes Handle	9960-286-002	9960-286-004	9960-286-004	9960-286-005	1

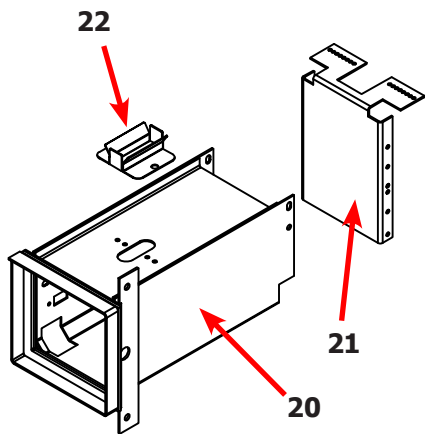
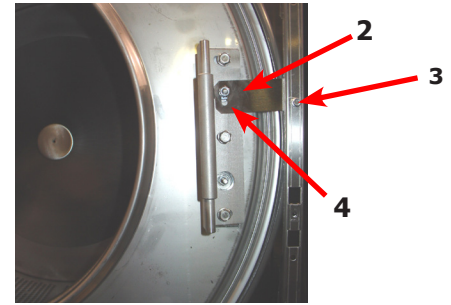

Key	Description	T650	T750	T950	T1450	QTY
17	Handle (bumper guard)	9244-086-002	9244-086-003	9244-086-003	9244-086-004	1
*	Rivet Blind 3/16" Alum	9491-009-003	9491-009-003	9491-009-003	9491-009-003	4
*	Screw		9545-045-010	9545-045-010	9545-045-010	4
18	Screw Mtg., Flat Head 10Bx1 3/4	9545-008-014	9545-008-014	9545-008-014	9545-008-014	2
19	Washer, Finish	8641-585-001	8641-585-001	8641-585-001	8641-585-001	2
*	Nut, Spring	8640-399-008	8640-399-008	8640-399-008	8640-399-008	2
20	Coin Vault, Black	9942-040-002	9942-040-002	9942-040-002	9942-040-002	1
21	Back-Coin Vault	9050-066-001	9050-060-001	9050-060-001	9050-060-001	1
*	Screw, 10B x 1/2	9545-008-026	9545-008-026	9545-008-026	9545-008-026	8
22	Chute, Coin	9119-032-001	9119-031-001	9119-028-001	9119-028-001	1
*	Screw, Coin Schute	9545-008-001	9545-008-001	9545-008-001	9545-008-001	2
23	Coin Box assy, Large Blue	9807-099-002	9807-099-002	9807-099-002	9807-099-002	1
23	Coin Box assy, Large Black	9807-099-004	9807-099-004	9807-099-004	9807-099-004	1

Cabinet and Front Panel Group Part # by Model

Front Soap Dish

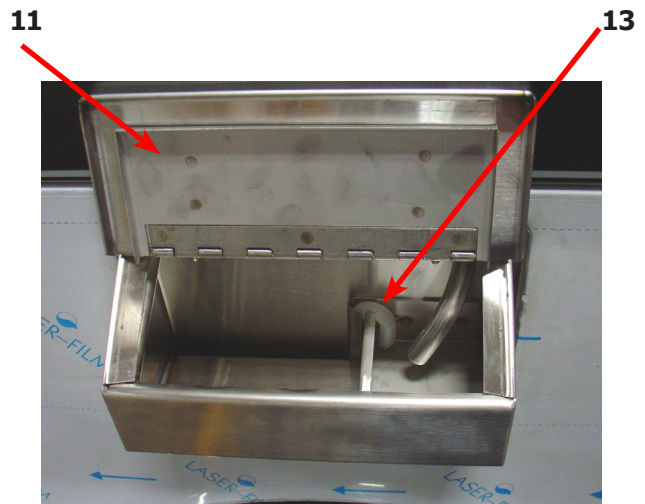
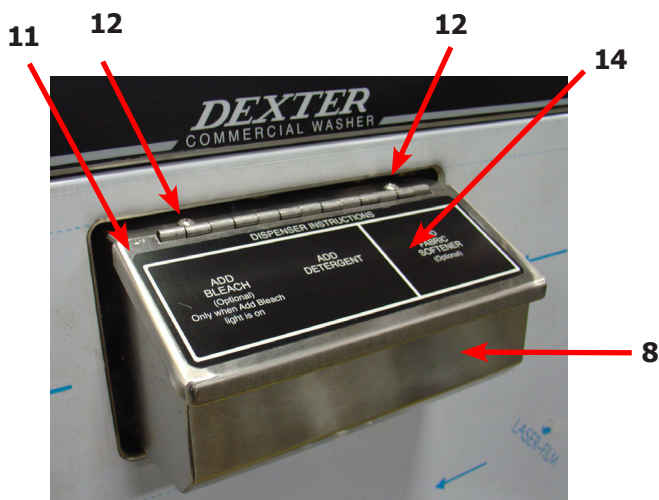
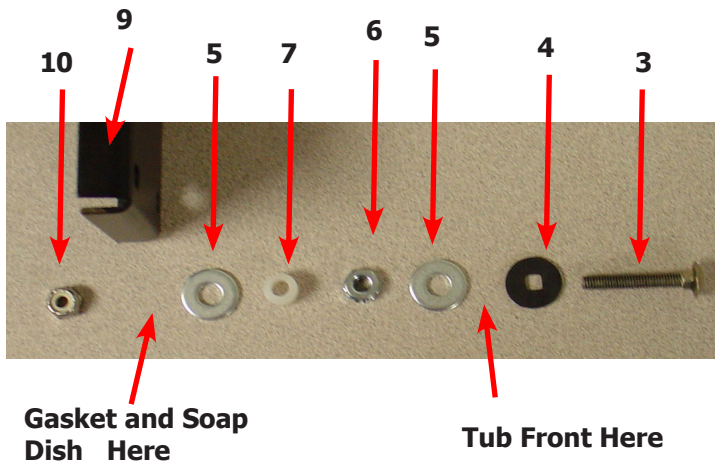

Front Mount Detergent Dispenser

Key	Description	T650	T750	T950	T1450	QTY
1	Screw, Locator	9545-008-023	9545-008-023	9545-008-023	9545-008-023	1
2	Plastic Sleeve, Locator	9355-001-001	9355-001-001	9355-001-001	9355-001-001	1
*	Catch, Top Panel	9086-017-001	9086-017-001	9086-017-001	9086-017-001	2
*	Lock, Top (w/Key)	8650-012-003	8650-012-003	8650-012-003	8650-012-003	2
3	Bolt,#10-32 x 1 1/4"SS	9545-012-026	9545-012-026	9545-012-026	9545-012-026	6
4	Special Washer, Rubber	8641-222-000	8641-222-000	8641-222-000	8641-222-000	6
*	Tub Front					1
5	Washer-Flat, 1/4	8641-581-018	8641-581-018	8641-581-018	8641-581-018	12
6	Nut, #10-32UNF	8640-413-002	8640-413-002	8640-413-002	8640-413-002	6
7	Spacer Plastic #10x1/2	9538-157-019	9538-157-019	9538-157-019	9538-157-019	6
8	Soap Dispenser (no lid)	9807-087-001	9807-087-001	9807-087-001	9807-087-001	1
*	Det. Dispenser Mtg Gasket to Tub frnt	9206-425-001	9206-425-001	9206-425-001	9206-425-001	1
9	Bracket Soap box mounting	9029-122-002	9029-122-002	9029-122-002	9029-122-002	1
10	Nut Hex Elasticstop #10-32 SS mtg dispenser	8640-413-006	8640-413-006	8640-413-006	8640-413-006	6
11	Lid Assembly dispenser	9987-104-001	9987-104-001	9987-104-001	9987-104-001	1
12	Lid screws #10-32x1/2 SS	9545-012-017	9545-012-017	9545-012-017	9545-012-017	2
13	Softner siphon tube (plastic)	9574-252-002	9574-252-002	9574-252-002	9574-252-002	1
*	Flow restrictors	9475-002-003	9475-002-003	9475-002-003	9475-002-003	AR
14	Washer Dispenser Label Blue	8502-756-002	8502-756-002	8502-756-002	8502-756-002	1
14	Washer Dispenser Label Black	8502-756-001	8502-756-001	8502-756-001	8502-756-001	1

Rear View Access Part # by Model

Key	Description	T650	T750	T950	T1450	QTY
1	Drive Motor, 3 Phase	9376-319-001	9376-329-001	9376-329-001	9376-326-001	1
2	Rod, Motor Mtg	9497-222-004	9497-222-004	9497-222-004	9497-222-004	1
3	Motor-Bushing, Support	9053-082-001	9053-082-001	9053-082-001	9053-082-001	2
4	Clamp for motor bushing	8654-117-019	8654-117-019	8654-117-019	8654-117-019	2
5	Pulley, Motor	9453-170-003	9453-179-001	9453-175-002	9453-175-002	1
	Set, Screw	9545-028-015				
5	Split TaperBushing (motor pulley)		9053-077-001	9053-077-001		2
*	Screw taper bushing 1/4-20x1	9732-	9545-018-024	9545-018-024		3
6	Bolt, Eye (1/4"-20x1/2")	9545-055-001	9545-055-001	9545-055-001	9545-055-001	1
*	Nut, 1/4 Elastic Stop	8640-414-003	8640-414-003	8640-414-003	8640-414-003	1
*	Link (open end)		9341-046-001	9341-046-001	9341-046-001	1
7	Chain (Spring Tension)		9099-012-003	9099-012-003	9099-012-004	1
*	Bracket Belt Tension, Mounts on Moter	9029-206-001				
*	Nut, 10-32	8640-413-002				
8	Spring, Belt Tension	9534-151-000	9534-151-000	9534-151-000	9534-151-000	1
9	Pulley, Driven	9453-173-002	9453-173-002	9453-176-005	9453-176-005	1
*	Tolerance Ring	9487-234-004	9487-234-004			1
10	Screw, 5/8"-11 x 2"	9545-060-004	9545-060-004			1
11	Washer-Flat, 5/8"	8641-582-032	8641-582-032			1
12	Washer-Flat, 5/8"	8641-582-018	8641-582-018			1
10	Washer-Flat .675x2-1/2x1/4			8641-581-043		1
11	Lockwasher-Exttooth, 5/8			8641-582-018		1
12	Bolt, 5/8-11x1 1/2			9545-060-001		1
10	Washer-Flat, .781x2-1/2x1/4				8641-581-044	1
11	Lockwasher-Exttooth, 3/4				8641-582-020	1
12	Bolt, 3/4-10-1 1/2				9545-057-004	1
13	Bushing Taperlock (Pulley)			9053-078-002	9053-078-002	1
14	Bolt, 3/8"-16 x 2"			9545-029-011	9545-029-011	3
15	Washer, 3/8"			8641-582-003	8641-582-003	3
16	Drive Belt			9040-079-002	9040-079-006	1
16	Drive Belt	9040-076-005	9040-076-008			2
17	Hose, Overflow to drain	9242-449-002	9242-449-003	9242-449-003	9242-449-005	1
*	Clamp, Hose overflow to drain	8654-117-018	8654-117-018	8654-117-018	8654-117-018	2
18	Hose, Overflow Vent Top	9242-463-004	9242-463-004	9242-463-004	9242-463-006	1
*	Clamp, Hose Vent	8654-117-008	8654-117-008	8654-117-008	8654-117-008	1
*	Vaccum Breaker ALL	9610-001-001	9610-001-001	9610-001-001	9610-001-001	1
*	Clamp, Hose to Vacuum Breaker	8654-117-014	8654-117-014	8654-117-014	8654-117-014	2
19	Hose, Vacuum Breaker to tub	9242-458-003	9242-458-003	9242-458-003	9242-458-003	1
*	Vaccum Breaker Bracket	9029-077-001	9029-077-001	9029-077-001	9029-266-001	1
*	Inlet cap			0935-135-001		2
20	Hose, Pressure Switch	9242-175-004	9242-175-007	9242-175-007	9242-175-004	1
*	Clamp, Pressure Switch Hose	8654-117-015	8654-117-015	8654-117-015	8654-117-015	1
21	Channel, Rear,	9947-032-001	9947-027-001	9947-028-001	9947-029-001	1
22	Screw #10Bx1/2	9545-008-026	9545-008-026	9545-008-026	9545-008-026	4
*	Nut, Spring	8640-399-004	8640-399-004	8640-399-004	8640-399-004	4
23	Cover, Terminal Block	9074-267-001	9074-267-001	9074-267-001	9074-267-001	1
*	Screw #10Bx1/2	9545-008-026	9545-008-026	9545-008-026	9545-008-026	1

50 Lb. Pulley

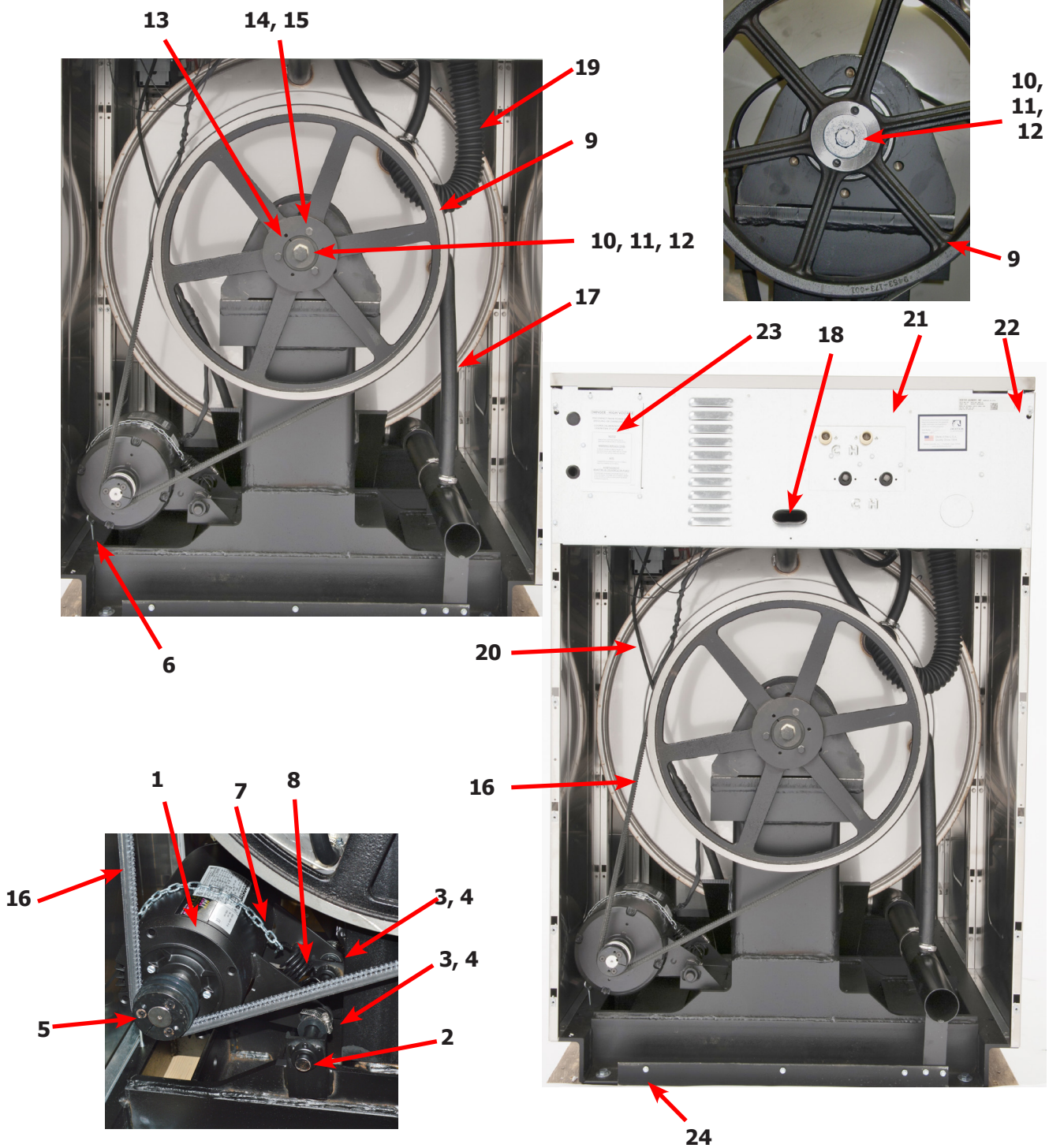

Key	Description	T650	T750	T950	T1450	QTY
*	Panel Assy., Back	9989-567-001	9989-455-001	9989-526-001		1
*	Panel Assy., Back, Upper				9454-873-001	
*	Panel Assy., Back, Lower				9454-872-001	
*	Screw Panel Mtg.#10Bx1/2"	9545-008-026	9545-008-026	9545-008-026		9
*	Screw Panel Mtg.#10Bx1/2"				9545-008-026	13
*	Nut, Spring	8640-399-008	8640-399-008	8640-399-008	8640-399-008	AR
28	Screw, To Base-1/4" x 3/4"	9545-030-002	9545-030-002	9545-030-002	9545-030-002	3

Cylinder, Seals & Bearings Part # by Model

Key	Description	T650	T750	T950	T1450	QTY
*	Bearings and Seal Kit	9732-219-007	9732-219-007	9732-219-007	9732-219-009	1
*	Housing, Bearing- Assembly (items #2-#6)	9803-187-001	9803-187-001	9803-187-001	9803-209-001	1
2	Housing, Bearing	9241-181-004	9241-181-004	9241-181-004	9241-195-003	1
3	Bearing, Front (Small)	9036-159-006	9036-159-006	9036-159-006	9036-162-002	1
4	Bearing, Rear (Large)	9036-159-005	9036-159-005	9036-159-005	9036-162-001	1
5	Spacer, Bearing	9538-170-001	9538-170-001	9538-170-001	9538-185-001	1
6	Ring, Bearing Retainer	9487-238-004	9487-238-004	9487-238-004	9487-238-004	1
8	Seal, Small V85A	9532-140-007	9532-140-007	9532-140-007		1
8	Seal, Small V95A				9532-140-012	
9	Seal, Large V140A	9532-140-008	9532-140-008	9532-140-008	9532-140-008	1
10	Ring, Seal Mounting	9950-052-001	9950-052-001	9950-052-001	9950-062-001	1
11	Tub Back Mating Ring	9487-261-004	9487-261-004	9487-261-004	9487-261-005	1
11G	Mating Ring Guard Shield	9950-052-001	9950-052-001	9950-054-004	9487-276-001	1
12	Bolt, Tub End of Bearing Housing (7/16-14x1), Bolt from inside Tub	9545-059-004	9545-059-004	9545-059-004	9545-059-004	6
13	Washer, Flat	8641-581-034	8641-581-034	8641-581-034	8641-581-034	6
14	Screw-Hex Cap, 3/4"-10 x 3" (Bearing Housing to Frame)	9545-057-002	9545-057-002	9545-057-002		6
14	Screw-Hex Cap, 7/8"-10 x 3" (Bearing Housing to Frame)				9545-066-001	6
15	Washers Spherical 3/4 (Male half) (Bearing Housing to Frame)	8641-588-001	8641-588-001	8641-588-001		6
15	Washers Spherical 7/8 (Male half) (Bearing Housing to Frame)				8641-588-003	
16	Washers Spherical 3/4 (Female half) (Bearing Housing to Frame)	8641-588-002	8641-588-002	8641-588-002		6
16	Washers Spherical 7/8 (Female half) (Bearing Housing to Frame)				8641-588-004	6
17	Nut 3/4"-10 (Bearing Housing to Frame)	8640-418-003	8640-418-003	8640-418-003		6
17	Nut 7/8"-9 (Bearing Housing to Frame)				8640-437-001	6
18	Pulley, Driven	9453-173-002	9453-173-002	9453-176-005	9453-176-005	1
*	Tolerance Ring	9487-234-004	9487-234-004			1
*	Screw, 5/8"-11 x 2"	9545-060-004	9545-060-004			1
*	Washer-Flat, 5/8"	8641-582-032	8641-582-032			1
*	Washer-Flat, 5/8"	8641-582-018	8641-582-018			1
19	Bolt, 3/8"-16 x 2"			9545-029-011	9545-029-011	3
20	Washer, 3/8"			8641-582-003	8641-582-003	3
21	Bushing Taperlock (Driven & Large)			9053-078-002	9053-078-002	1
22	Washer-Flat .675x2-1/2x1/4	8641-582-032	8641-582-032	8641-581-043		1
23	Lockwasher-Exttooth, 5/8	8641-582-018	8641-582-018	8641-582-018		1
24	Bolt, 5/8-11x1 1/2	9545-060-004	9545-060-004	9545-060-001		1
22	Washer-Flat, .781x2-1/2x1/4				8641-581-044	1
23	Lockwasher-Exttooth, 3/4				8641-582-020	1
24	Bolt, 3/4-10-1 1/2				9545-057-004	1
25	Tub & Cylinder Assy	9869-035-001	9869-025-002	9869-027-002	9869-026-001	1
*	Cylinder Assy	9848-145-001	9848-136-002	9848-136-001	9848-141-001	1

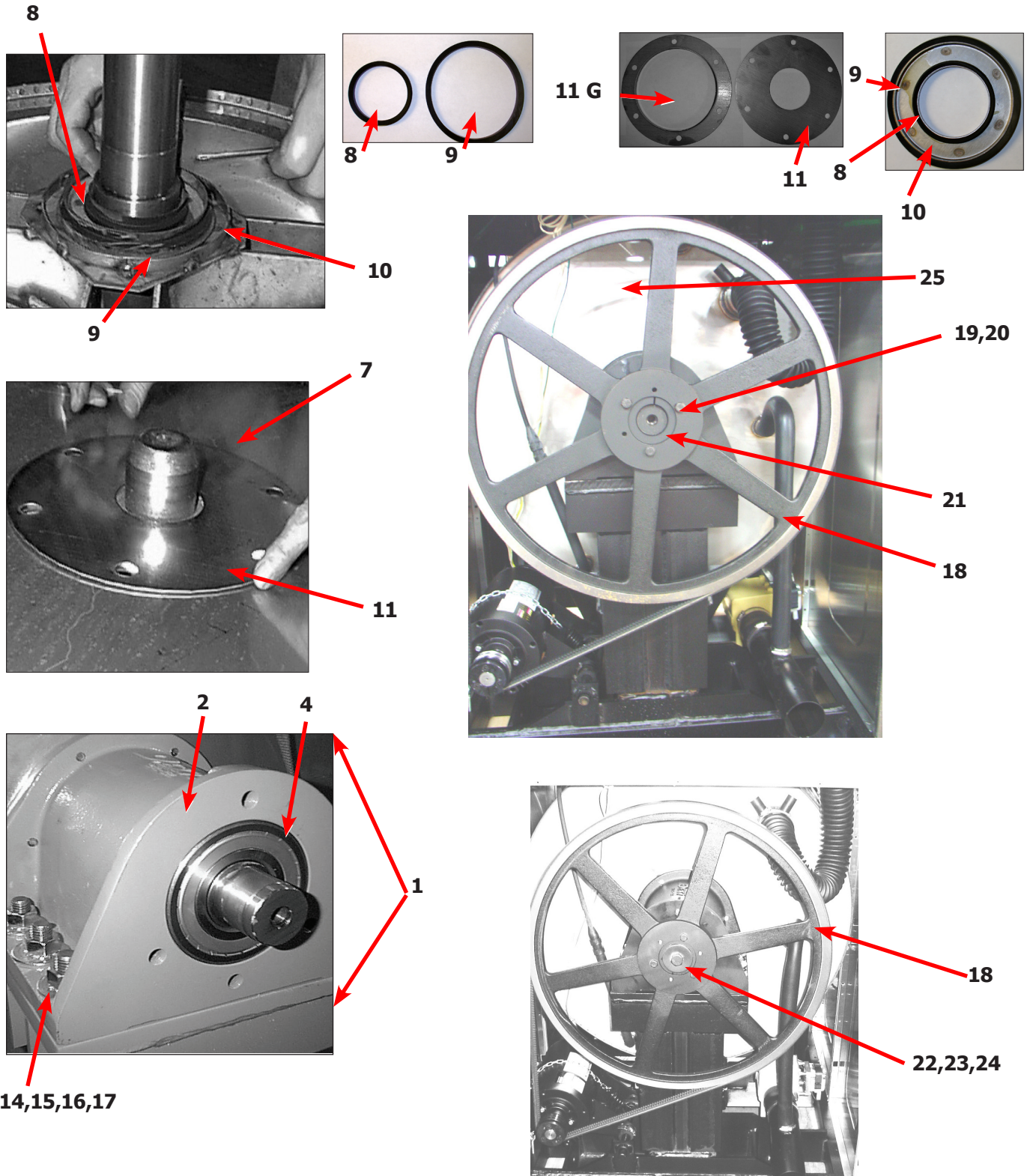

14,15,16,17

Key	Description	T650	T750	T950	T1450	QTY
*	Tub Front	9974-014-001	9974-011-001	9974-011-002	9974-012-001	1
*	Gasket, Tub Front	9206-421-004	9206-421-002	9206-421-002	9206-421-002	1
*	Ring Assy, Tub Mtg-Front Clamp	9950-063-001	9950-055-001	9950-055-001	9950-061-001	1
*	Bolt, Top Front Ring 3/8"-16 x 3"	9545-029-009	9545-029-009	9545-029-009	9545-029-009	1
*	Nut WCAD 3/8"-16	8640-415-001	8640-415-001	8640-415-001	8640-415-001	1

Door Lock Assembly (All Models)

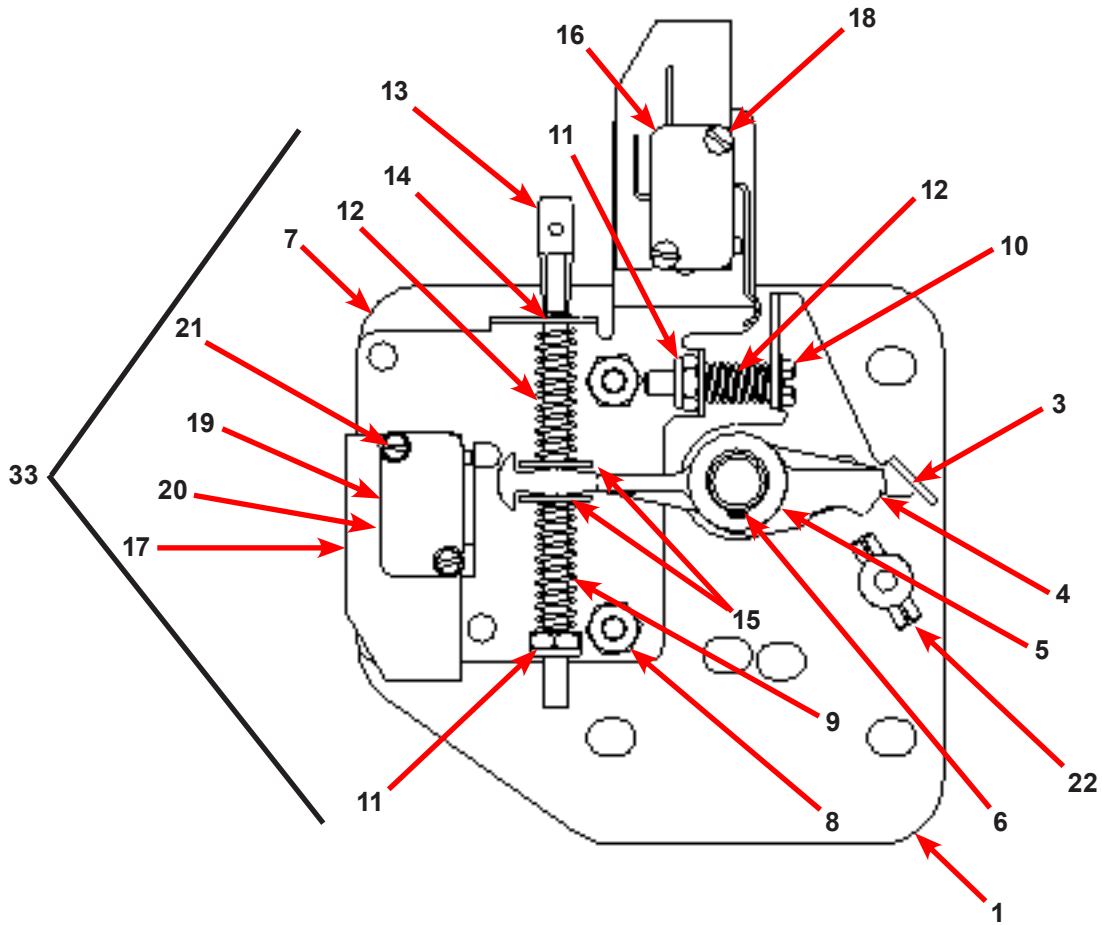

Key	Description	All Models	QTY
33	Lock Assy, Complete (#1-22) (includes #1 thru #22)	9885-024-001	1
1	Plate Assy, Door Lock	9982-346-001	1
2	Washer, Flat (SS or Brass)	8641-581-030	1
3	Actuator, Latching Switch	9008-005-001	1
4	Pawl, Locking	9732-346-002	1
5	Washer, Spring	8641-569-003	1
6	Ring, Retaining	9487-200-004	1
7	Bracket Switch	9029-163-001	1
8	Nut, Hex 10-32 UNF	8640-413-002	2
9	Spring, Actuating	9534-364-002	1
10	Screw, Hx. 10-32 x 1"	9545-012-020	1
11	Nut, Elastic Stop 10-32	8640-413-004	2
12	Spring, Return	9534-364-001	2
13	Pin, Guide	9451-193-001	1

Key	Description	All Models	QTY
14	Ring, Retaining	9487-200-005	1
15	Washer	8641-581-031	1
16	Switch, Latching Sensing	9539-461-008	1
17	Shield, Switch	9550-169-003	3
18	Screw 4-40 x 5/8"	9545-020-001	2
18	Nut, Twin 4-40	8640-401-001	1
19	Switch, Locking Sensing	9539-461-007	2
20	Actuator, Switch Locking	9008-006-003	1
21	Screw 4-40 x 1 1/8"	9545-020-003	2
21	Nut, Twin 4-40	8640-401-001	1
*	Spacer Sensor	9538-182-001	*
22	Pin, Dowel (for door cam)	9451-181-004	1
*	Shim, Door Lock, Thin	9552-037-001	AR
*	Screw, Lock mtg 1/4"-20 x 3/4"	9545-018-014	3
*	Lockwasher 1/4" Ext tooth	8641-582-007	3
*	Door Stud Pin, 3/16" x 3/4"	9451-181-004	1

Gear Motor Door Lock Assembly

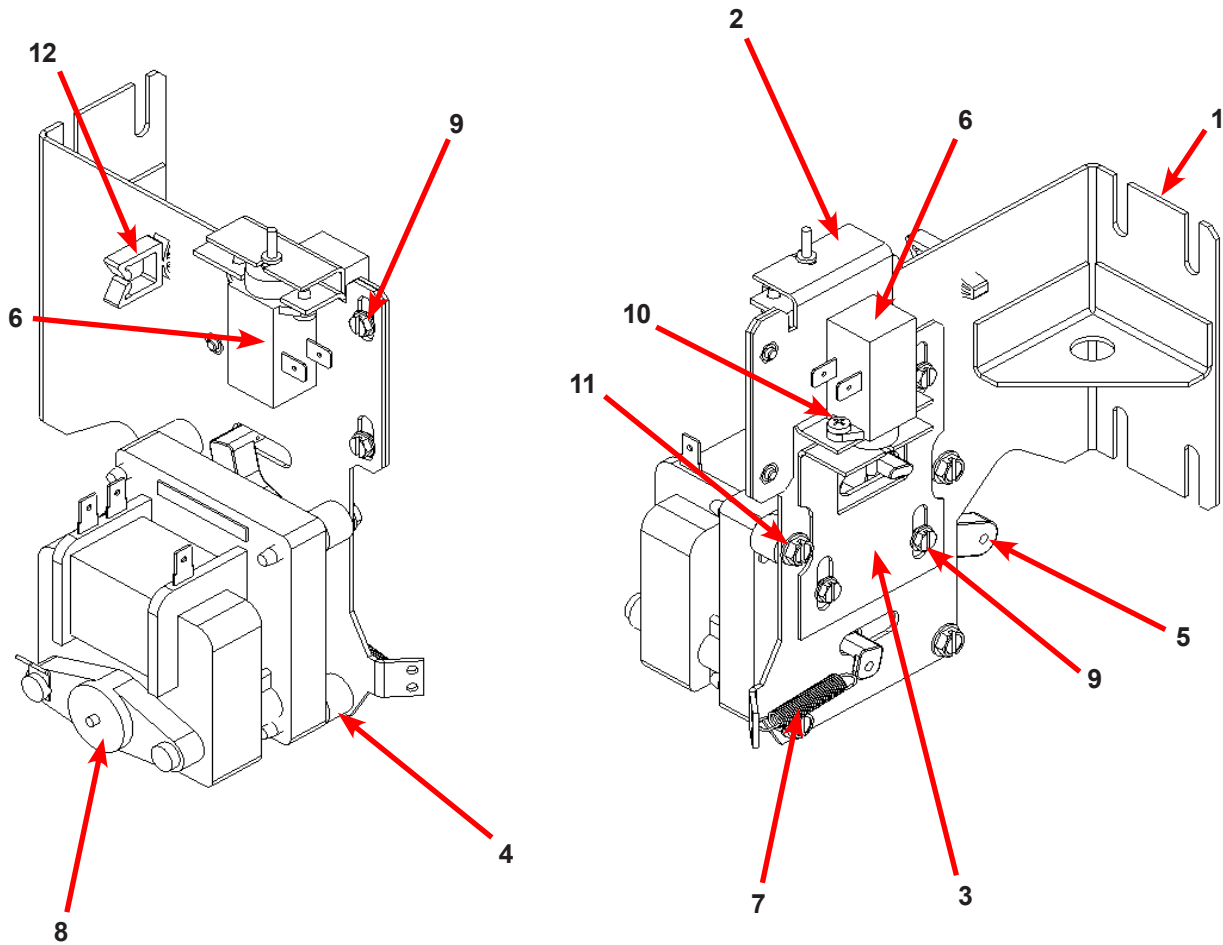

Key	Description	T650	T750	T950	T1450	QTY
*	Actuator Assembly (Includes 1-10, Rod NOT included)	9892-015-001	9892-015-001	9892-015-001	9892-015-001	1
1	Bracket Assy, Slide Lock Actuator	9985-190-001	9985-190-001	9985-190-001	9985-190-001	1
2	Bracket Assy, Slide - Unlock	9985-189-001	9985-189-001	9985-189-001	9985-189-001	1
3	Bracket Slide Lock	9029-204-001	9029-204-001	9029-204-001	9029-204-001	1
4	Spacer, Plastic	9538-157-021	9538-157-021	9538-157-021	9538-157-021	4
5	Arm - Door Lock	9001-063-001	9001-063-001	9001-063-001	9001-063-001	1
6	Thermoactuator - Door Lock Relay 120v	9586-001-001	9586-001-001	9586-001-001	9586-001-001	2
7	Spring - Extension	9534-350-001	9534-350-001	9534-350-001	9534-350-001	1
8	Motor & Gear Assembly 120v	9914-137-015	9914-137-015	9914-137-015	9914-137-015	1
9	Screw -HxwshrhdsIsems, 6-32 x 3/16	9545-044-003	9545-044-003	9545-044-003	9545-044-003	6
10	Cross Recessed PAn Hd Tapping screw	9545-031-011	9545-031-011	9545-031-011	9545-031-011	4
11	Screw - hxwshdsl, 10-24 - 1.25f, ctd	9545-046-007	9545-046-007	9545-046-007	9545-046-007	4
12	Standoff-Wire	9527-007-001	9527-007-001	9527-007-001	9527-007-001	1
*	Rod, Door Lock	9497-225-017	9497-225-013	9497-225-015	9497-225-016	1
*	Harness, Door Lock/Drain, P17	9627-791-004	9627-796-001	9627-796-001	9627-796-001	1

Large Door & Hinge Group

Key	Description	T650	T750	T950	T1450	QTY
1	Door Hinge Assembly (mounts to tub front)	9955-030-001	9955-031-001	9955-031-001	9955-031-001	1
*	Door Assembly Complete	9960-309-001	9960-310-001	9960-310-001	9960-310-001	1
2	Door Ring 180 degree large hnge	9487-265-002	9487-275-001	9487-275-001	9487-275-001	1
3	Door Gasket	9206-419-001	9206-431-001	9206-431-001	9206-431-001	1
4	Door Glass Window	9635-016-001	9635-020-001	9635-020-001	9635-020-001	1
*	Red Wire (Door Close Switch)	8220-063-025	8220-063-028	8220-063-028	8220-063-028	1
*	Black Wire (Door Close Switch)	8220-063-026	8220-063-029	8220-063-029	8220-063-029	1
5	Switch, Door Hinge Close (Plunger)	9539-492-001	9539-492-001	9539-492-001	9539-492-001	1
6	Top Door Hinge Leaf	9845-008-001	9845-006-001	9845-006-001	9845-006-001	1
7	Bottom Door Hinge Leaf	9845-005-002	9845-007-001	9845-007-001	9845-007-001	1
8	Thrd Form Screw, Door Mtg 5/16" x 5/8"	9545-056-002	9545-056-002	9545-056-002	9545-056-002	4
9	Screw, Loading Door Hinge Mtg (5/16" x9/16" ss)	9545-014-009	9545-014-013	9545-014-013	9545-014-013	3
9	Washer, Star 5/16	9913-134-003	9913-134-003	9913-134-003	9913-134-003	3
10	Bracket Retainer support side panel	9046-094-001	9046-085-001	9046-085-001	9046-085-001	1
*	Shim Large door	9552-036-001	9552-043-001	9552-043-001	9552-043-001	1

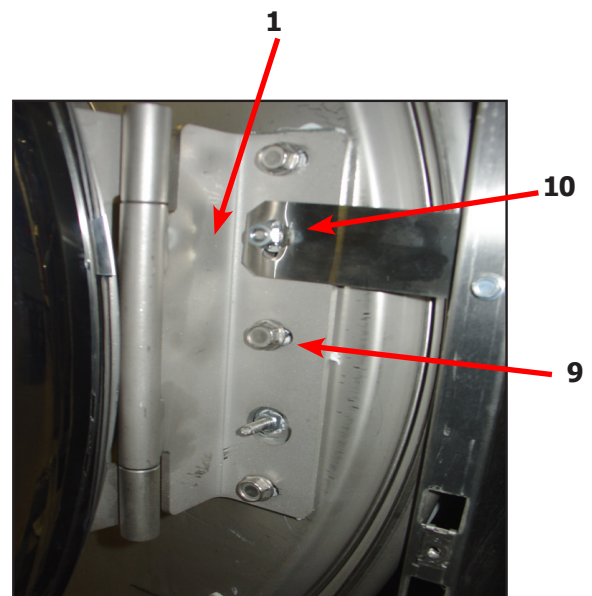

Key	Description	T650	T750	T950	T1450	QTY
*	Shaft Assembly-Loading Door (11-14)	9913-134-003	9913-134-003	9913-134-003	9913-134-003	1
11	Shaft, Door Locking	9537-195-002	9537-195-002	9537-195-002	9537-195-002	1
12	Cam, Locking	9095-040-002	9095-040-002	9095-040-002	9095-040-002	1
13	Pin, Groove (1 1/4)	9451-181-005	9451-181-005	9451-181-005	9451-181-005	1
14	Pin, Groove (3/4)	9451-181-004	9451-181-004	9451-181-004	9451-181-004	1
15	Spring, Lock Cam	9534-360-002	9534-360-002	9534-360-002	9534-360-002	1
16	Handle, Door	9244-091-001	9244-091-001	9244-091-001	9244-091-001	1
17	Pin, Door Handle (groove)	9451-181-005	9451-181-005	9451-181-005	9451-181-005	1
18	Trim, Edge	9578-092-005	9578-092-002	9578-092-002	9578-092-002	1

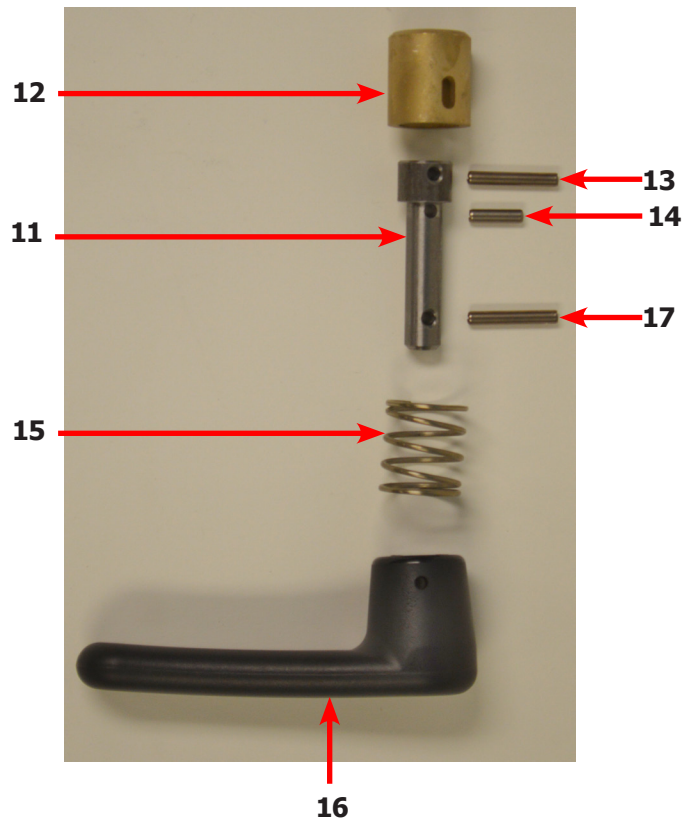
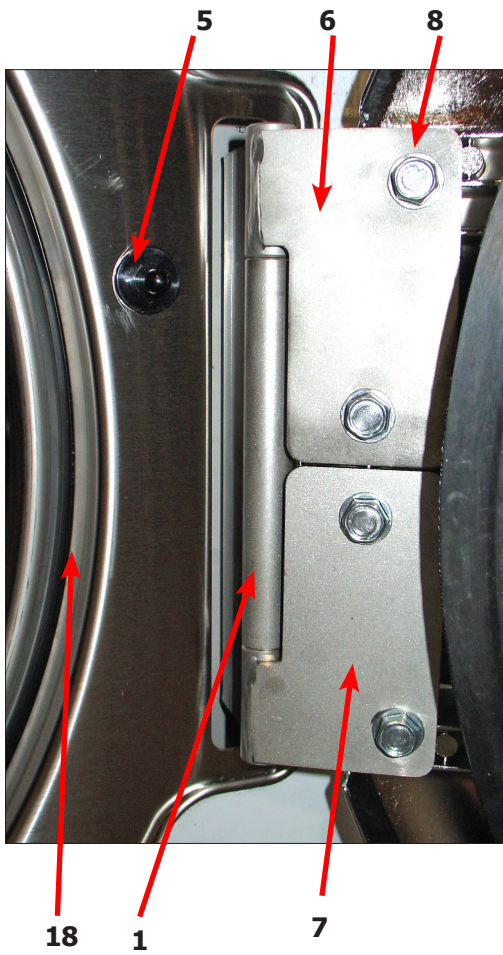

Water Inlet & Rear Channel

Key	Description	T650	T750	QTY
1	Channel Assembly, Rear	9947-032-001	9947-027-001	1
2	Screw, #10B x 1/2	9545-008-026	9545-008-026	6
*	Clip, Spring nut	8640-399-004	8640-399-004	6
3	Mounting Plate Water Valves	9452-813-001	9452-813-001	1
4	Nut-Hes Keps, #10-32, 2B	8640-413-002	8640-413-002	2
5	Valve, Water Inlet (dual outlet) (see Water Inlet Valve Breakdown for individual parts)	9379-183-012	9379-183-012	2
6	Screw, Valve Mtg	9545-008-026	9545-008-026	4
7	Wire-Assy, Jumper, Yellow	8220-123-001	8220-123-001	1
8	Shield over Water Valves Plastic	9550-194-001	9550-194-001	1
9	Push Clip	9083-121-001	9083-121-001	3
10	Vacuum Breaker	9610-001-001	9610-001-001	1
*	Bracket, Vacuum Breaker	9029-077-001	9029-077-001	1
11	Screw, #10B x 1/2	9545-008-026	9545-008-026	4
*	Clamp, Hose to Vacume Braker	8654-117-014	8654-117-014	1
*	Hose, Vacuum Breaker to Tub	9242-458-003	9242-458-003	1
*	Clamp, Tub End	8654-117-009	8654-117-009	1
12	Hose, Valve to Vac. Braker	9242-453-020	9242-453-020	4
*	Hose, Cold, Vac. Brkr. dispenser	9242-453-013	9242-453-013	1
*	Hose, Hot, Vac. Brkr. dispenser	9242-453-007	9242-453-007	1
13	Clamp, Hose-Worm	8654-117-015	8654-117-015	12
14	Hose, overflow Suds	9242-450-002	9242-450-002	4
*	Clamp, Hose-Spring (overflow to tub back)	8654-117-018	8654-117-018	2
15	Plate Assembly, Drive Mounting	9982-383-001	9982-383-001	1
16	Nut-#10-32UNF, 2B	8640-413-002	8640-413-002	8
17	VFD Delta "E drive 208-240 volt	9375-030-013	9375-028-010	1
*	Key Pad-Display Delta "E" Drive	9150-044-001	9150-044-001	1
18	Cable-Data, Communication	9806-015-001	9806-015-001	1
19	Bushing, 7/8	9053-067-002	9053-067-002	1
20	Plug, 7/8	9545-041-006	9545-041-006	1
21	Bracket, Terminal-Mounting	9029-265-001	9029-265-001	1
22	Screw, #10B x 1/2	9545-008-026	9545-008-026	4
23	Label-Warning	8502-639-001	8502-639-001	1
24	Strip-Terminal Marker	9558-025-001	9558-025-001	1
25	Terminal Block	9897-033-002	9897-033-002	1
26	Screw-Phillips, 6ABx3/4	9545-031-010	9545-031-010	2
27	Harness-Power, Terminal Block	9627-747-003	9627-747-003	1
28	Bushing, 1"	9053-067-004	9053-067-004	1
29	Terminal Lug, Solderless	8652-134-001	8652-134-001	1
30	Lock-Washer Exttooth #10	8641-582-006	8641-582-006	1
30	Screw, #10-32 TTX 1/2 GRN	9545-008-027	9545-008-027	1
31	Bushing, 3/4	9053-067-001	9053-067-001	1
32	Braking resistors (200 ohm)	9483-004-002	9483-004-002	2
33	Screw-#10Bx1/2	9545-008-026	9545-008-026	4

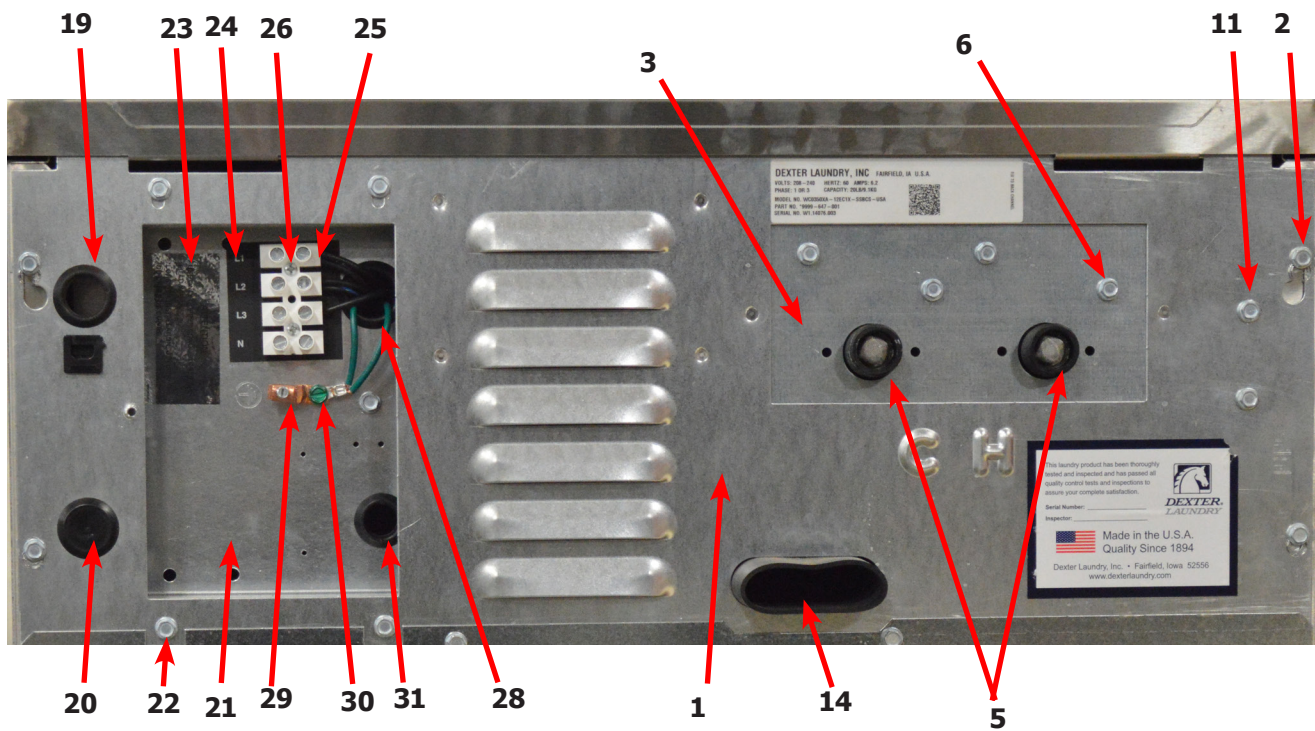
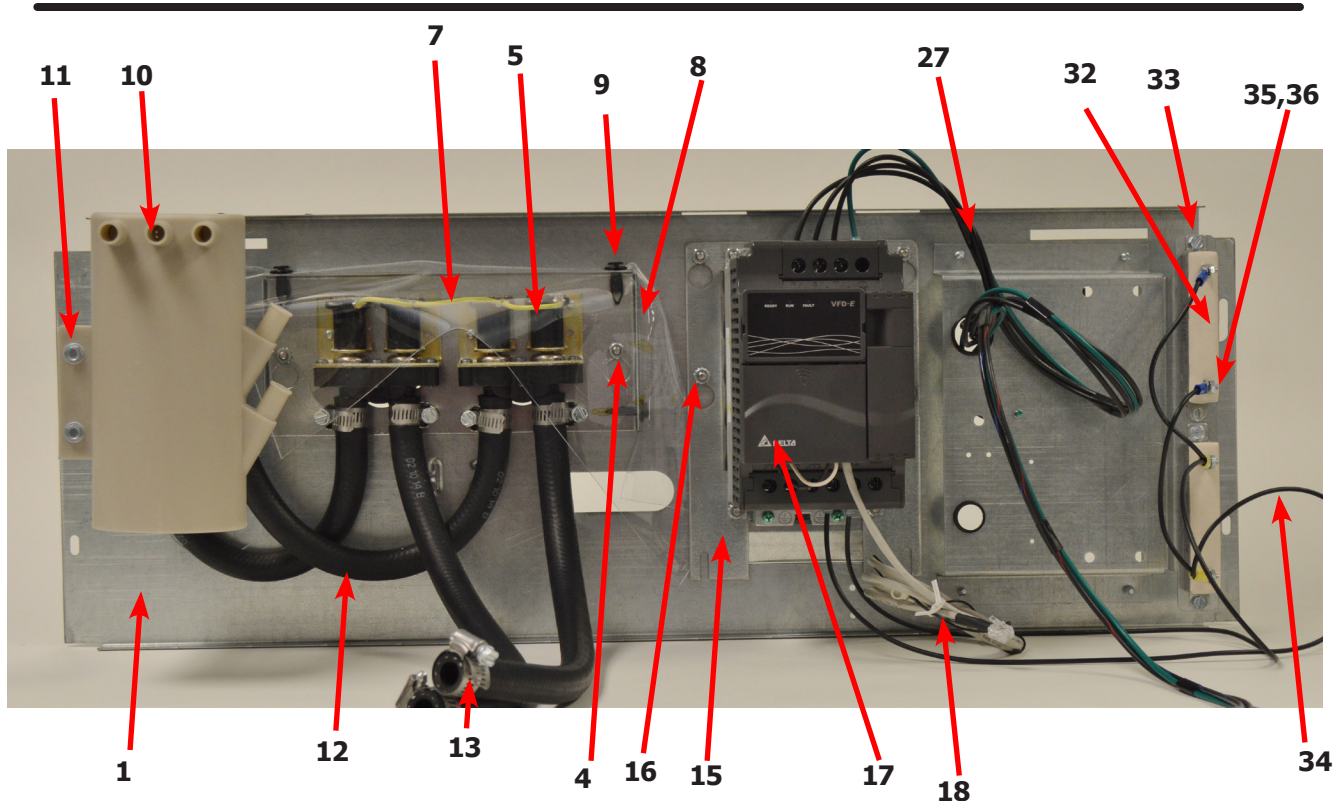

Key	Description	T650	T750	QTY
34	Wire Assy, Jumper	8220-117-002	8220-117-002	2
35	Screw, #6-32x5/16	9545-044-006	9545-044-006	4
36	Nut, #6-32	8640-411-003	8640-411-003	4
*	Cover Controls	9074-267-001	9074-267-001	1
*	Screw-#10Bx1/2	9545-008-026	9545-008-026	1
*	Label-Warning, Notice	8502-761-001	8502-761-001	1

Water Inlet & Rear Channel

Key	Description	T950	T1450	QTY
1	Channel Assembly, Rear	9497-028-001	9497-029-001	1
*	Screw, #10B x 1/2	9545-008-026	9545-008-026	6
*	Clip, Spring	8640-399-004	8640-399-004	6
2	Mounting Plate Water Valves	9452-814-001	9452-814-001	1
3	Nut-Elastic stop, #10-32	8640-413-002	8640-413-002	2
4	Valve, Water Inlet (dual outlet) (see Water Inlet Valve Breakdown for individual parts)	9379-183-012	9379-183-012	2
5	Screw, Valve Mtg	9545-008-026	9545-008-026	4
8	Valve, Water Inlet (Single outlet) (see Water Inlet Valve Breakdown for individual parts)	9379-194-001	9379-194-001	2
*	Screw, M4x0 7 x 8mm	9545-064-001	9545-064-001	4
*	Wire-Assy, Jumper, Yellow	8220-119-002	8220-119-002	1
9	Shield over Water Valves Plastic	9550-195-001	9550-195-001	1
10	Push Clip	9083-121-001	9083-121-001	3
11	Vacuum Breaker	9610-001-001	9610-001-001	1
12	Vacuun Breaker Cap (Red)	0935-135-002	0935-135-002	3
*	Bracket, Vacuum Breaker	9029-077-001	9029-077-001	1
13	Screw, #10B x 1/2	9545-008-026	9545-008-026	4
*	Clamp, Hose to Vacume Braker	8654-117-014	8654-117-014	1
*	Hose, Vacuum Breaker to Tub	9242-458-003	9242-458-003	1
*	Clamp, Tub End	8654-117-009	8654-117-009	1
*	Hose, overflow Suds	9242-463-004	9242-463-004	4
*	Clamp, Hose-Spring (overflow to tub back)	8654-117-018	8654-117-018	2
14	Plate Assembly, Drive Mounting	9982-383-001	9982-383-001	1
15	Nut-#10-32UNF, 2B	8640-413-002	8640-413-002	4
16	VFD Delta "E drive 208-240 volt	9375-028-017	9375-029-007	1
*	VFD Cooling Fan	9189-013-001	9189-014-001	1
*	Wire assy Brown, 3"	8220-057-035	8220-057-035	1
*	Wire assy Red, 3"	8220-057-036	8220-057-036	1
*	Key Pad-Display Delta "E" Drive	9150-044-001	9150-044-001	1
*	Cable-Data, Communication	9806-015-001	9806-015-001	1
17	Bushing, 7/8	9053-067-002	9053-067-002	1
18	Plug, 7/8	9545-041-006	9545-041-006	1
19	Bracket, Terminal-Mounting	9029-265-001	9029-265-001	1
20	Screw, #10B x 1/2	9545-008-026	9545-008-026	4
21	Label-Warning	8502-639-001	8502-639-001	1
22	Strip-Terminal Marker	9558-025-001	9558-025-001	1
23	Terminal Block	9897-033-002	9897-033-002	1
24	Screw-Phillips, 6ABx3/4	9545-031-010	9545-031-010	2
25	Harness-Power, Terminal Block	9627-747-003	9627-747-003	1
26	Bushing, 1"	9053-067-004	9053-067-004	1
27	Terminal Lug, Solderless	8652-134-001	8652-134-001	1
28	Lock-Washer Extooth #10	8641-582-006	8641-582-006	1
29	Screw, #10-32 TTX 1/2 GRN	9545-008-027	9545-008-027	1

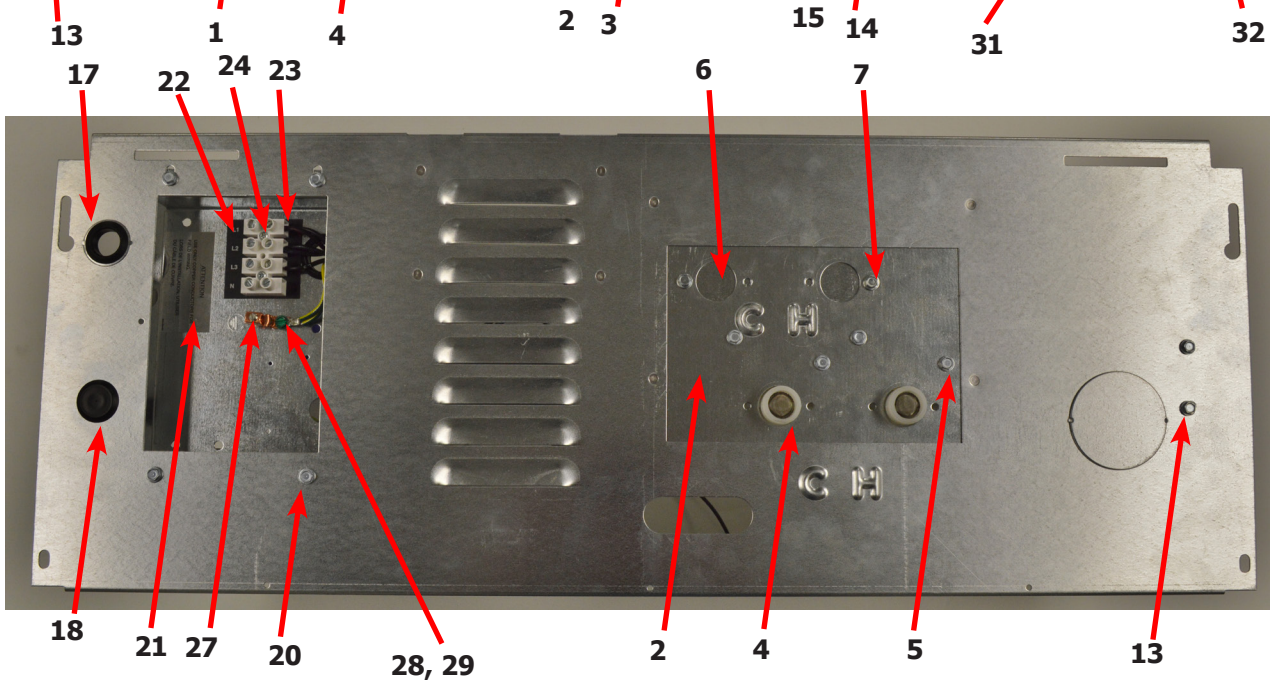
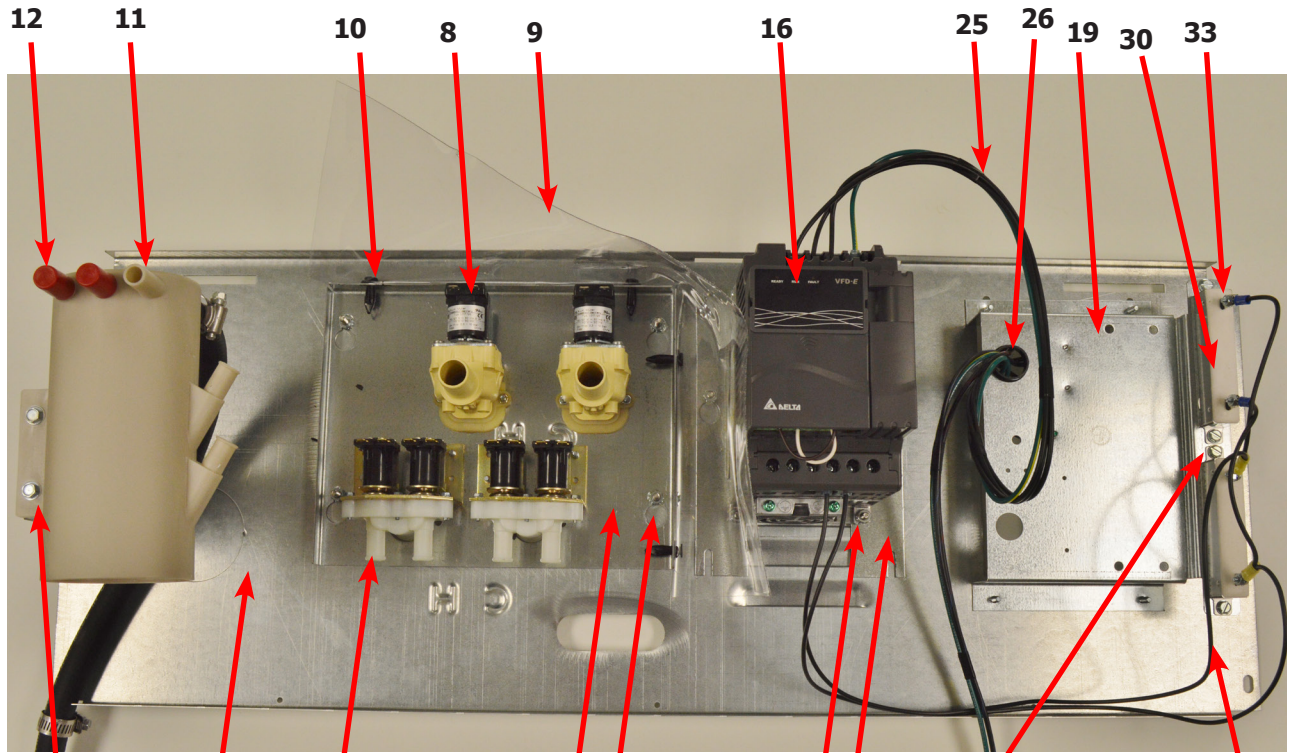

Key	Description	T950	T1450	QTY
30	Braking resistors (200 ohm)	9483-004-003	9483-004-003	2
31	Screw-#10Bx1/2	9545-008-026	9545-008-026	4
32	Wire Assy, Jumper	8220-117-002	8220-117-002	2
33	Screw, #6-32x5/16	9545-044-006	9545-044-006	4
33	Nut, #6-32	8640-411-003	8640-411-003	4
*	Cover Controls	9074-267-001	9074-267-001	1
*	Screw-#10Bx1/2	9545-008-026	9545-008-026	1
*	Label-Warning, Notice	8502-761-001	8502-761-001	1

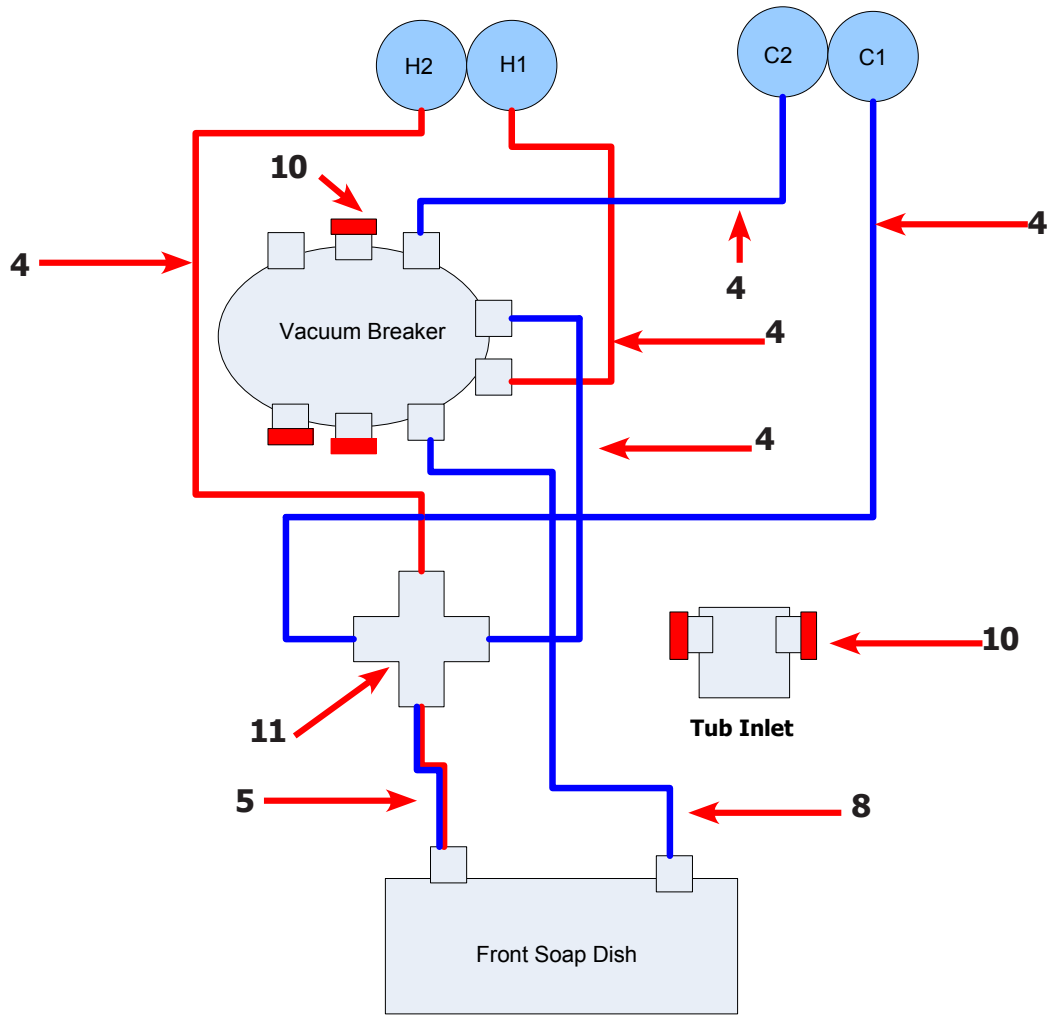

**Soap Flush
Setup Front Soap Dish
T900 Coin
T650 & T750**

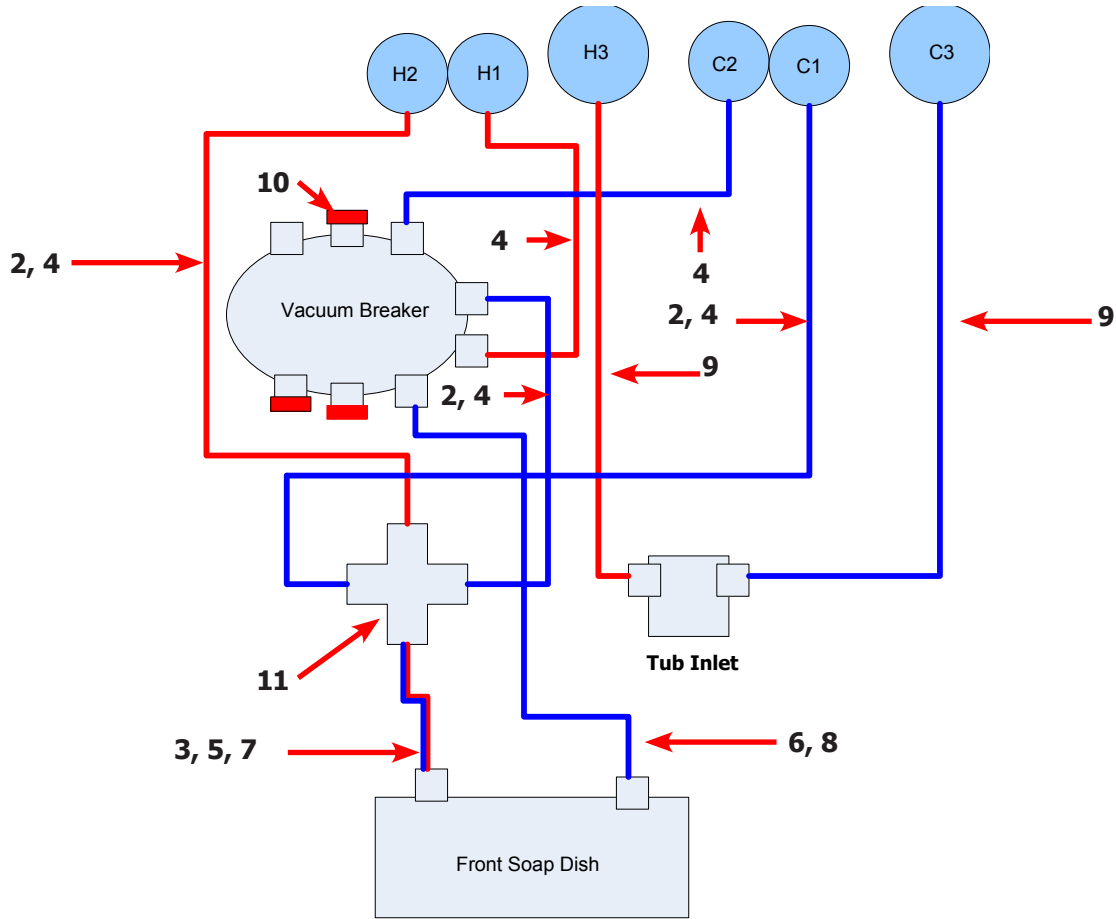

**Soap Flush
Setup New Front Soap Dish
T950, T1200, & T1450**

Key	Description	T650	T750	T950	T1450
1	9242-453-006 Hose-water,20" 1/2 I.D.		1		
2	9242-453-009 Hose-water,23" 1/2 I.D.	1	1		2
3	9242-453-018 Hose-water,29" 1/2 I.D.				1
4	9242-453-020 Hose-water,18" 1/2 I.D.	4	4	5	3
5	9242-453-021 Hose-water,31" 1/2 I.D.			1	
6	9242-453-022 Hose-water,43" 1/2 I.D.				
7	9242-453-023 Hose-water,40" 1/2 I.D.				1
8	9242-453-024 Hose-water,37" 1/2 I.D.	2		1	
9	9242-453-025 Hose-water,19" 7/8 I.D.			2	
9	9242-453-026 Hose-water,25" 7/8 I.D.				2
10	0935-135-002 Fill Cap, (Red)			3	3
11	8615-118-001 Fitting-Cross, 1/2"			1	1
*	8654-117-015 Clamp 1" SS	14	12	14	14
*	8654-117-017 Clamp 1 1/4" SS			4	4

Water Inlet Valve Breakdown Part # by Model

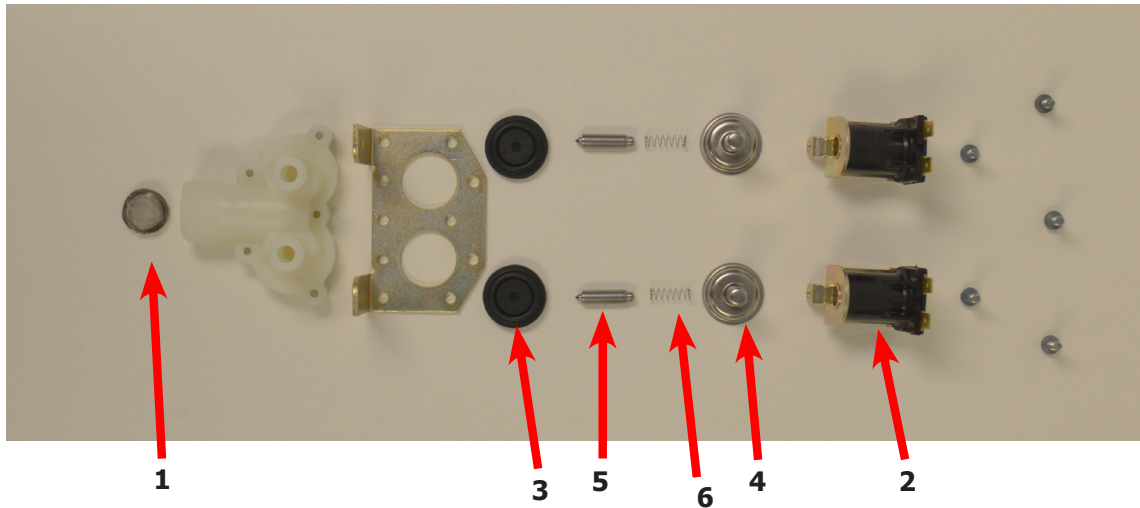

Key	Description	T650	T750	T950	T1450	QTY
*	Valve, Water Inlet (includes 1 thru 6) - Invensys	9379-183-012	9379-183-012	9379-183-012	9379-183-012	2
1	Screen, Inlet end of valve	9555-056-001	9555-056-001	9555-056-001	9555-056-001	2
2	Coil Assy., 120 V Invensys	9089-017-001	9089-017-001	9089-017-001	9089-017-001	2
3	Diaphragm Invensys (EPDM)	9118-049-003	9118-049-003	9118-049-003	9118-049-003	2
3	Diaphragm Invensys (Viton)	9118-049-002	9118-049-002	9118-049-002	9118-049-002	2
4	Guide, Solenoid Invensys	9211-021-002	9211-021-002	9211-021-002	9211-021-002	2
5	Armature Invensys	9015-008-001	9015-008-001	9015-008-001	9015-008-001	2
6	Spring, Armature Invensys	9534-298-001	9534-298-001	9534-298-001	9534-298-001	2
*	Optional Diaphran (Viaton)	9118-049-002	9118-049-002	9118-049-002	9118-049-002	2
*	Wiring Harness	9794-001-001				1

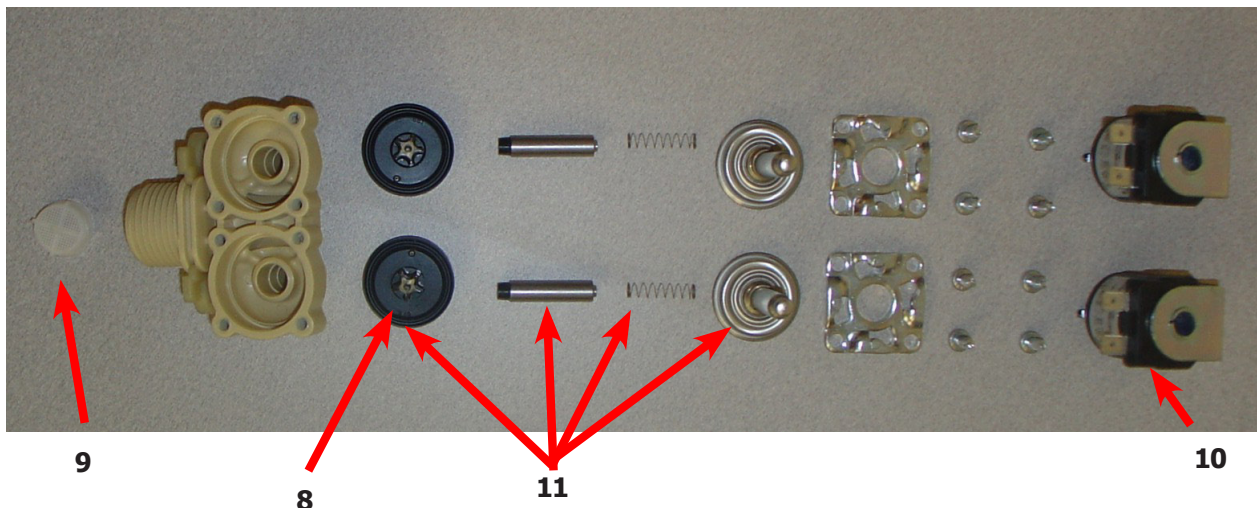

Optional Water Valve

Key	Description	T650	T750	T950	T1450	QTY
*	Dual Coil Water Valve Mueller	9379-192-001	9379-192-001	9379-192-001	9379-192-001	1
7	Valve Water Body Complete(no coil)	9379-192-002	9379-192-002	9379-192-002	9379-192-002	1
8	Diaphragm Mueller	9118-054-001	9118-054-001	9118-054-001	9118-054-001	2
9	Filter Mueller	9183-046-001	9183-046-001	9183-046-001	9183-046-001	2
10	Coil Mueller	9089-051-001	9089-051-001	9089-051-001	9089-051-001	2
11	Diaphragm Assembly Mueller Includes	9785-001-001	9785-001-001	9785-001-001	9785-001-001	2

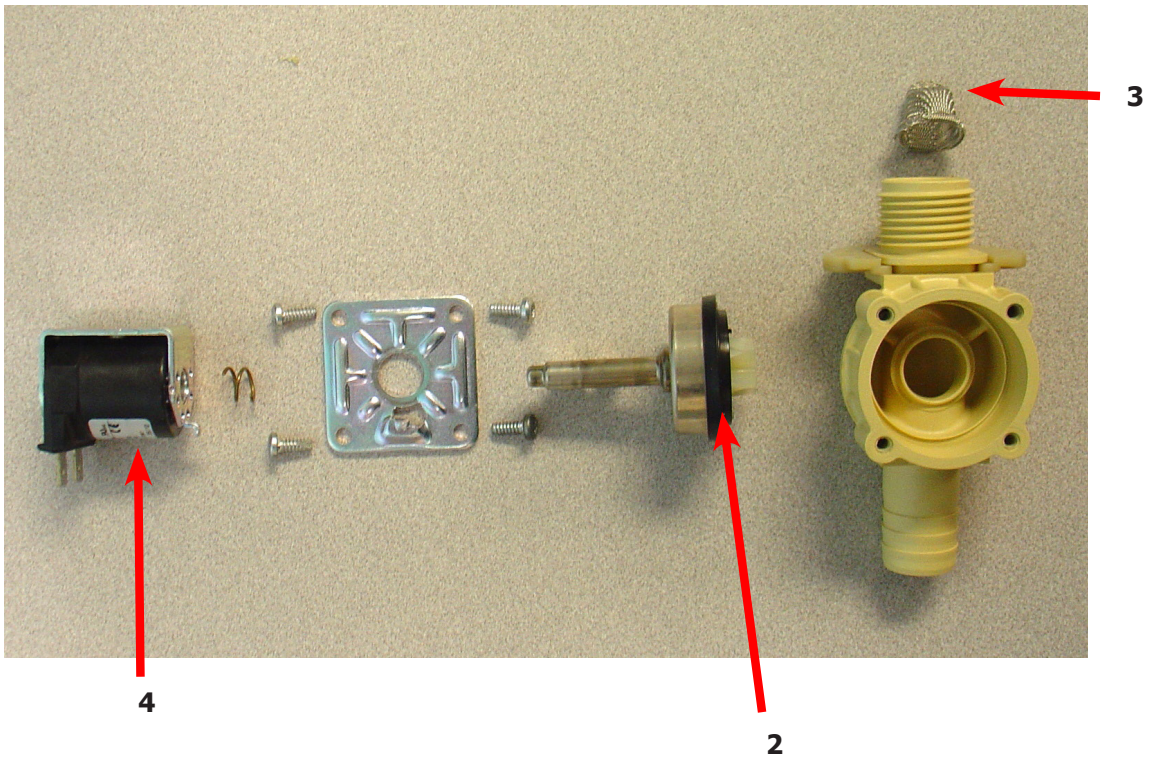

Key	Description	T650	T750	T950	T1450	QTY
*	Single Coil Water Valve Mueller			9379-194-001	9379-194-001	1
1	Valve Water Body Complete (no coil)			9379-194-002	9379-194-002	1
2	Diaphragm Mueller			9118-055-001	9118-055-001	1
3	Filter Mueller			9183-046-001	9183-046-001	1
4	Coil Mueller			9089-051-001	9089-051-001	1

Drain Valve Group Part # by Model

Key	Description	Part Number	Qty
1	Valve, Drain (includes #2 thru #11)	9379-202-001	1
2	Body, Valve (w/ball)	9064-072-001	1
3	Motor & Gear Train (complete)	9914-137-023	1
4	Plate, Motor Mtg	9452-538-001	1
5	Screw	8639-994-001	1
6	Spring, Drive	9534-339-001	1
7	Screw	9545-054-001	1
8	Screw	9545-054-002	1
9	Seal, V Packer	9532-134-001	1
10	Washer	8641-584-001	1
11	Pin, Main Drive	9451-196-001	1
*	Plate (spacers needed for replacement motor mtg. plate)	9538-149-001	1
12	Kit - Seal Replacement	9732-327-001	1

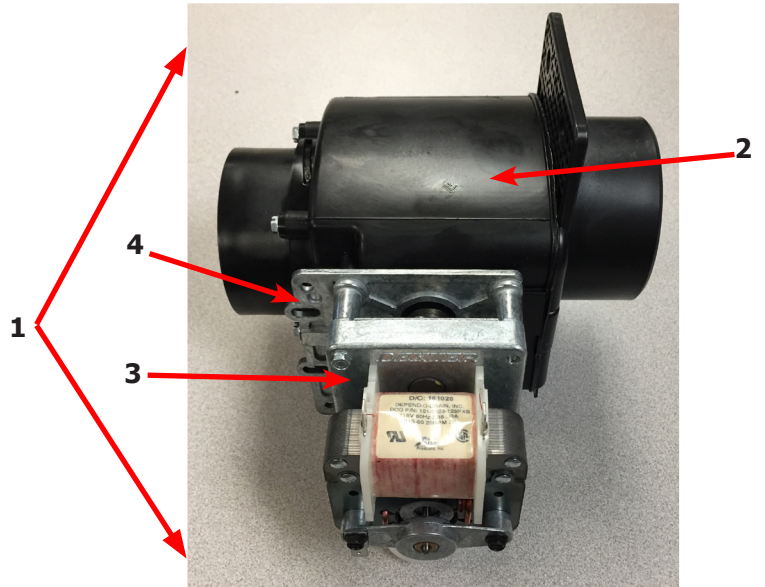
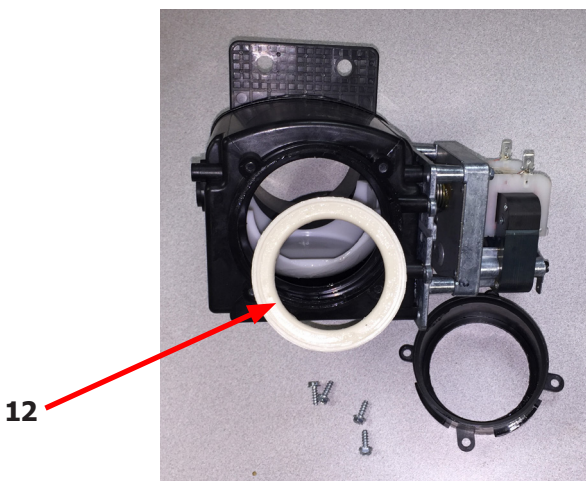

9, 10, 11

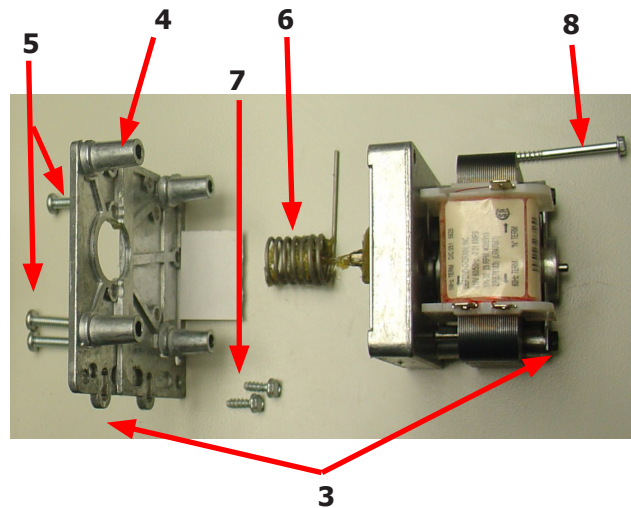

3

Notes

Chassis and Drain Part # by Model

Key	Description	T650	T750	T950	T1450	QTY
1	Base Assy,Frame	9945-143-002	9945-112-002	9945-128-002	9945-133-002	1
2	Outer Tub Assy	9930-167-001	9930-148-001	9930-156-001	9930-155-001	1
*	Tub & Cylinder Assy	9869-035-001	9869-025-002	9869-027-002	9869-026-001	1
3	Tub Front	9974-014-001	9974-011-001	9974-011-002	9947-012-001	1
*	Gasket, Tub Front	9206-421-004	9206-421-002	9206-421-002	9206-421-002	1
4	Ring Assy, Tub Mtg-Front Clamp	9950-063-001	9950-055-001	9950-055-001	9950-061-001	1
5	Bolt, Top Front Ring 3/8"-16 x 3"	9545-029-009	9545-029-009	9545-029-009	9545-029-009	1
6	Nut WCAD 3/8"-16	8640-415-001	8640-415-001	8640-415-001	8640-415-001	1
7	Bolt, 1/2" -13 x 2" (Tub Mounting to Frame)	9545-017-013	9545-017-013	9545-017-013	9545-017-013	2
8	Nut, Wizloc 1/2" x 13	8640-417-005	8640-417-005	8640-417-005	8640-417-005	2
9	Washer, Flat 1/2"	8641-581-026	8641-581-026	8641-581-026	8641-581-026	2
10	Hose, Tub to Drain Valve	9242-464-001	9242-456-001	9242-456-001	9242-459-001	1
11	Clamp, Hose (Tub to Drain Valve)	8654-117-014	8654-117-014	8654-117-014	8654-117-008	2
12	Valve, Drain	9379-202-001	9379-202-001	9379-202-001	9379-202-001	1
*	Screw, Valve to Base 1/4Bx3/4	9545-030-002	9545-030-002	9545-030-002	9545-030-002	2
*	Washer, Flat 1/4	8641-581-018	8641-581-018	8641-581-018	8641-581-018	4
13	Hose, Drain Valve to Tube	9242-457-001	9242-457-001	9242-457-001	9242-457-001	1
*	Clamp, Hose (Drain Valve to Tube)	8654-117-014	8654-117-014	8654-117-014	8654-117-014	2
14	Tube Assy, Drain	9915-124-002	9915-124-002	9915-124-002	9915-129-002	1
15	Clamp, Hose (Tube to Frame Bracket)	8654-117-014	8654-117-014	8654-117-014	8654-117-014	1
*	Bracket, Drain Tube		9029-067-002			1
*	Screw Tube (Bracket to Base 1/4Bx3/4)	9545-030-002	9545-030-002	9545-030-002	9545-030-002	4
16	Hose, Overflow Tub To Drain Tube	9942-449-002	9942-449-003	9942-449-003	9942-449-005	1
*	Clamp, Hose	8654-117-018	8654-117-018	8654-117-018	8654-117-018	1
*	Tube, Suds overflow	9242-463-004	9242-463-004	9242-463-004	9242-463-006	1
*	Clamp, Hose	8654-117-008	8654-117-008	8654-117-008	8654-117-008	2
17	Hose, Pressure switch	9242-175-004	9242-175-007	9242-175-007	9242-175-004	1
	Clamp, Overflow Hose	8654-117-015	8654-117-015	8654-117-015	8654-117-015	1

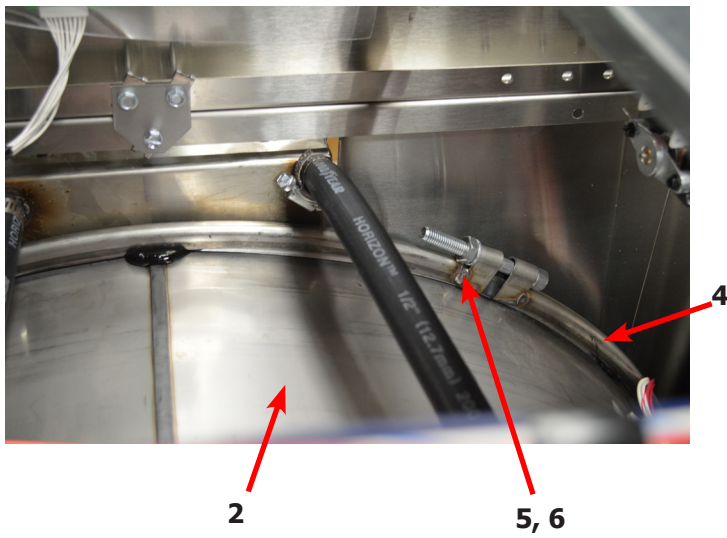
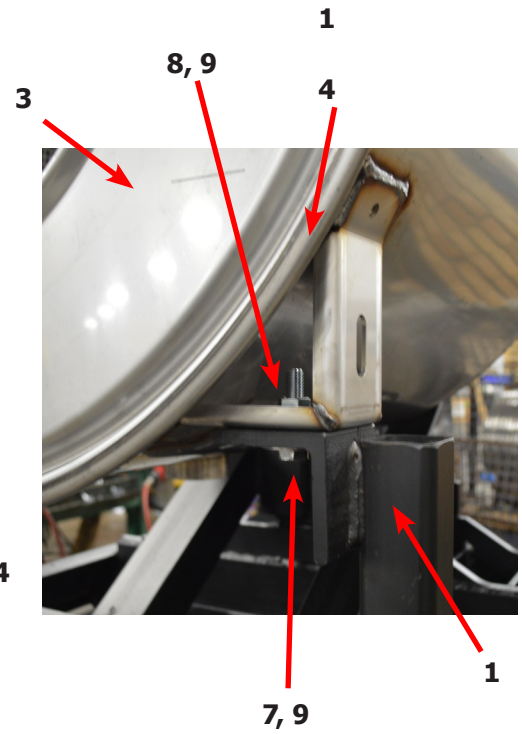
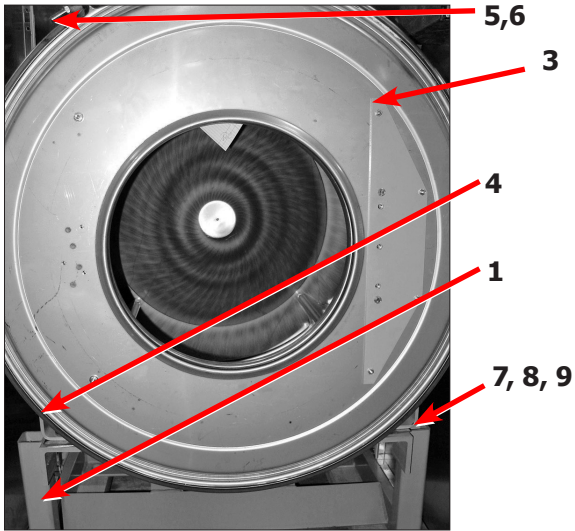
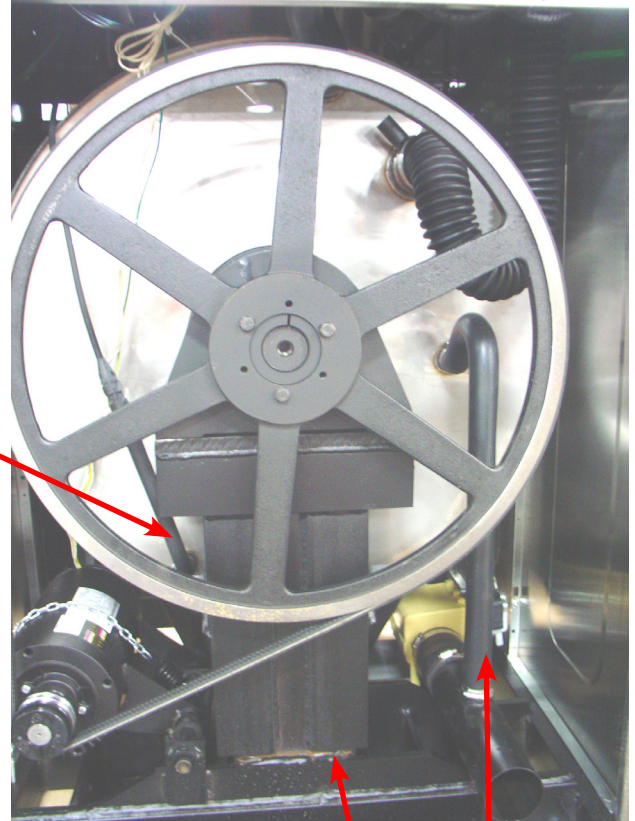
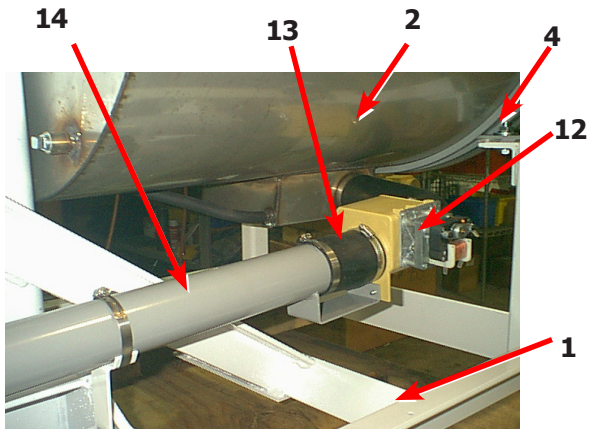

Electrical Components - Top Compartment

Key	Description	T650	T750	T950	T1450	QTY
1	Trough Assy, Controls 208-240 volt (all parts below #2-#43 & trough)	9857-220-001	9857-205-001	9857-206-002	9857-208-001	1
*	Trough only	9839-018-001	9839-018-001	9839-018-001	9839-017-001	1
*	Screw, Trough Sides	9545-008-026	9545-008-026	9545-008-026	9545-008-026	4
*	Lockwasher #10	8641-582-006	8641-582-006	8641-582-006	8641-582-006	4
2	Spreader-Chanel, Trough	9081-136-001	9081-136-001	9081-136-001	9081-136-001	
*	Screw, Mtg #8Bx1/4"	9545-008-026	9545-008-026	9545-008-026	9545-008-026	4
3	Transformer, Control (Secondary Voltage to 115 volts)	8711-004-001	8711-004-001	8711-004-001	8711-004-001	1
*	Screw, Mtg #10Bx1/2"	9545-008-026	9545-008-026	9545-008-026	9545-008-026	4
*	Lockwasher #10	8641-582-006	8641-582-006	8641-582-006	8641-582-006	4
4	Screw GRN. #10-32x 1/2"	9545-008-027	9545-008-027	9545-008-027	9545-008-027	1
5	Lockwasher #10	8641-582-006	8641-582-006	8641-582-006	8641-582-006	1
6	Lug, Grounding	8652-130-037	8652-130-037	8652-130-037	8652-130-037	1
7	PCB assembly Relay Main	9473-006-001	9473-006-001	9473-006-001	9473-006-001	1
*	Support, Edge Holding	9548-285-001	9548-285-001	9548-285-001	9548-285-001	6
*	Harness, P17 Drain/Therm/Sol	9627-796-002	9627-796-002	9627-796-002	9627-796-002	1
*	Harness P19/Water Valve	9627-795-004	9627-795-004	9627-795-004	9627-795-004	1
*	Harness P8/P16	9627-794-001	9627-794-001	9627-794-001	9627-794-001	1
*	Harness P20/P21	9627-793-001	9627-793-001	9627-793-001	9627-793-001	1
*	Bushing , Wire 7/8	9053-067-002	9053-067-002	9053-067-002	9053-067-002	2
*	Standoff Twistlock	9527-002-002	9527-002-002	9527-002-002	9527-002-002	3
8	Terminal Block Assy, POWER	9897-026-004	9897-026-004	9897-026-004	9897-026-004	1
*	Screw, Mtg 8Bx3/8"	9545-045-012	9545-045-012	9545-045-012	9545-045-012	2
9	Switch, Pressure		9539-457-004	9539-457-004	9539-457-002	1
*	Screw, Mtg #8Bx1/4"		9545-045-001	9545-045-001	9545-045-001	2
*	Harness P5/Pressure Switch	9627-908-008	9627-908-010	9627-908-012	9627-908-014	1
*	Kit-Pressure Sensor, Electronic (10-12b)	9732-314-001	9732-314-001	9732-314-001	9732-314-001	1
10	Kit-Repaacement, Pressure Sensor (only)	9732-315-001	9732-315-001	9732-315-001	9732-315-001	1
10a	Support-PCB, 3/8", Edge Holding	9458-285-001	9458-285-001	9458-285-001	9458-285-001	1
11	Transformer-120/18VAC, 5 VA	8711-015-001	8711-015-001	8711-015-001	8711-015-001	1
12	Screw, 8B x 1/4	9545-045-001	9545-045-001	9545-045-001	9545-045-001	1
12a	Wire Assy BLK/BLU	8220-001-233	8220-001-233	8220-001-233	8220-001-233	1
12b	Wire Assy RED/BLU	8220-001-232	8220-001-232	8220-001-232	8220-001-232	1
13	Transformer, (Step Down) 120/24VAC 50/60hz	8711-009-004	8711-009-004	8711-009-004	8711-009-004	1
*	Screw, Transformer Mtg #8Bx1/4"	9545-045-001	9545-045-001	9545-045-001	9545-045-001	4
*	Lockwasher #6 exttooth	8641-582-005	8641-582-005	8641-582-005	8641-582-005	4
14	Fuseholder	9200-001-002	9200-001-002	9200-001-002	9200-001-002	1
*	Fuse 1.5 amp	8636-018-001	8636-018-001	8636-018-001		1
*	Fuse 2.5 amp				8636-018-004	1
15	Label Fuse 1.5 amp Rear	8502-716-001	8502-716-001	8502-716-001		1
15	Label Fuse 2.5 amp Rear				8502-716-002	1
16	Angle Support Trough	9081-178-001	9003-278-001	9003-271-001		1
*	Screw, Trough Bracket	9545-008-026	9545-008-026	9545-008-026	9545-008-026	4
17	Chanel-Support, Trough	9081-171-001	9081-172-001	9081-172-001	9081-172-001	1
*	Screw, Mtg #10Bx1/2"	9545-008-026	9545-008-026	9545-008-026	9545-008-026	4
18	Chanel	9081-108-002	9081-108-002	9081-108-001	9081-155-001	1
*	Screw, Mtg #10Bx1/2"	9545-008-026	9545-008-026	9545-008-026	9545-008-026	2

Electrical Components - Top Compartment

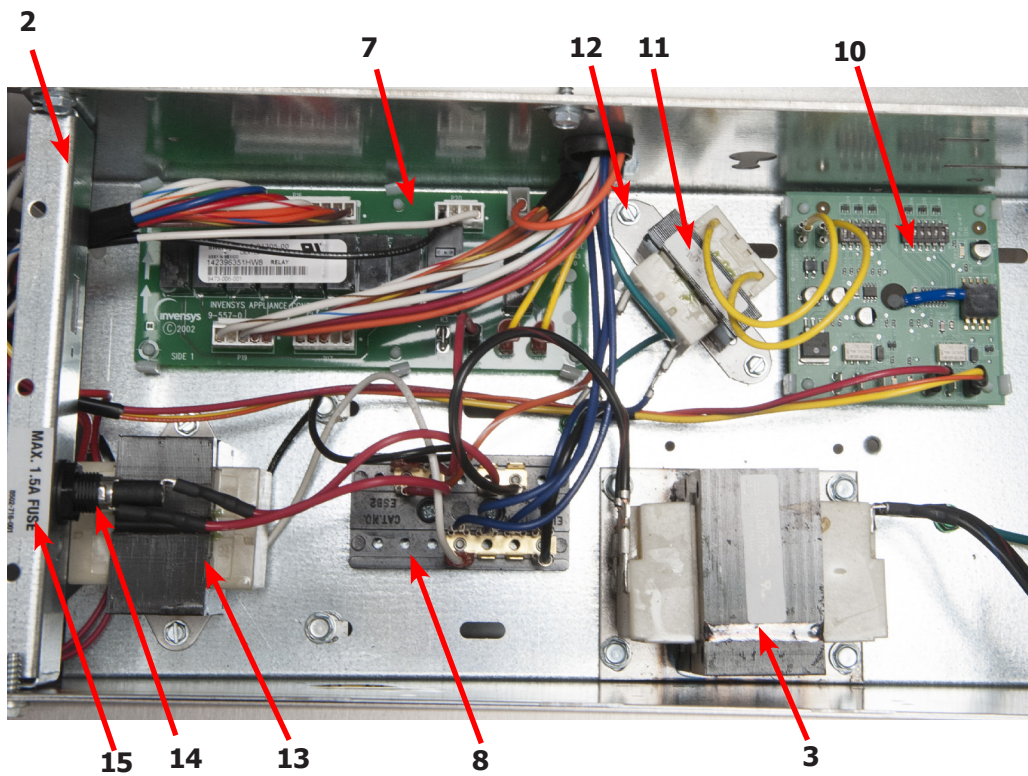
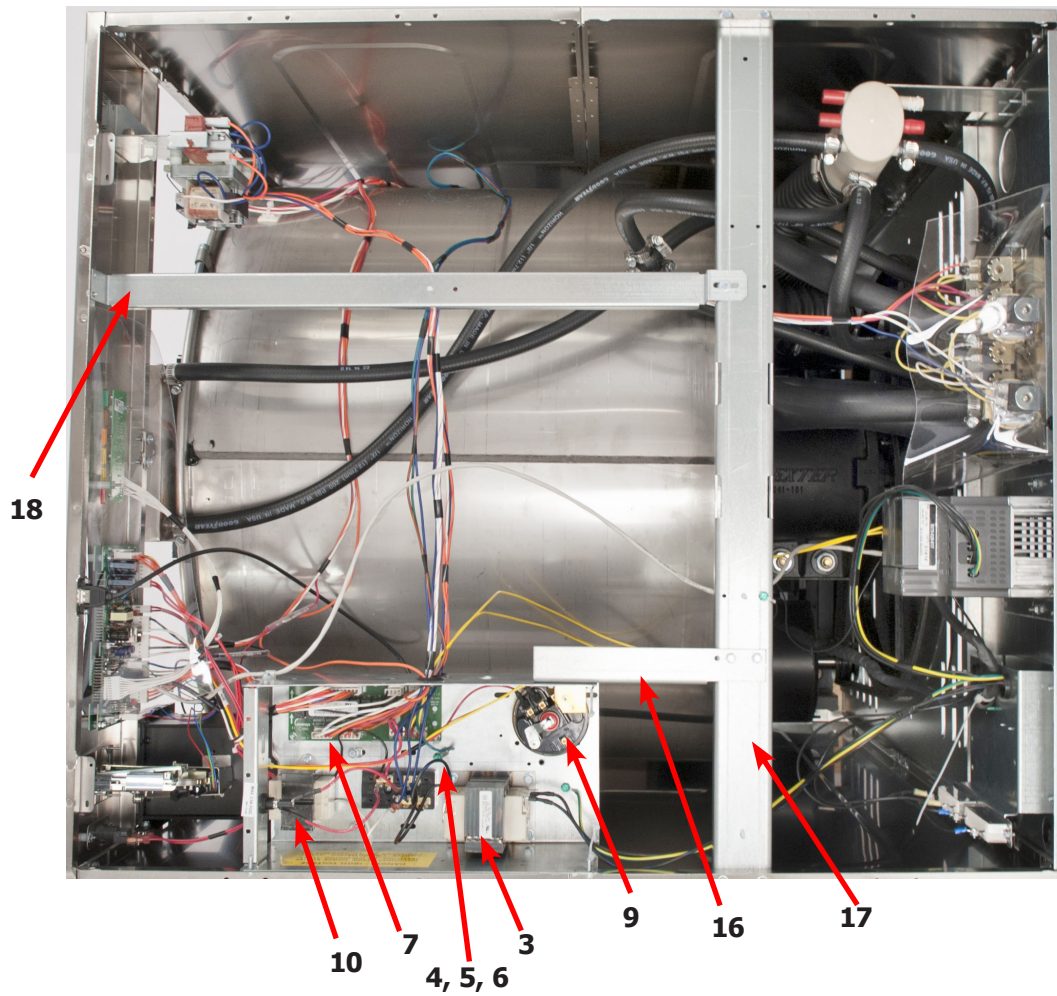

Electrical Trough w/Pressure Sensor

Control Panel Part # by Model

Key	Description	T650	T750	T950	T1450	QTY
1	Panel Control Assembly(panel only)	9989-559-001	9989-560-001	9989-560-001	9989-561-001	1
*	Screw, to Side Panels 5/16, Hxw-shrhdunct #10Bx 1/2"	9545-008-026	9545-008-026	9545-008-026	9545-008-026	4
2	Plate-Latch, Top	9452-625-001	9452-625-001	9452-625-001	9452-625-001	2
3	Nut, #8-32	8640-412-005	8640-412-005	8640-412-005	8640-412-005	4
4	Locator Panel	9355-001-001	9355-001-001	9355-001-001	9355-001-001	1
5	Screw FillHDCR 10Bx1/2" Guide	9545-008-023	9545-008-023	9545-008-023	9545-008-023	1
6	Spacer Pushbutton (Micro)	9538-192-001	9538-192-001	9538-192-001	9538-192-001	1
7	Pushbutton Control (coin)[Blue]	9035-062-001	9035-062-001	9035-062-001	9035-062-001	1
7	Pushbutton Control (coin)[Black]	9035-062-003	9035-062-003	9035-062-003	9035-062-003	1
8	Retainer Pushbutton (Micro)	9486-160-001	9486-160-001	9486-160-001	9486-160-001	1
9	Nut Hexelasticstop #4-40	8640-424-002	8640-424-002	8640-424-002	8640-424-002	2
10	Spacer Plastic #6x9/16	9538-157-018	9538-157-018	9538-157-018	9538-157-018	5
11	PCB assembly Control /Display STOP	9473-010-001	9473-010-001	9473-010-001	9473-010-001	1
12	Nut Elasticstop #6-32	8640-411-002	8640-411-002	8640-411-002	8640-411-002	4
13	Nut-Hexkeps, #6-32	8640-411-003	8640-411-003	8640-411-003	8640-411-003	1
14	Harness LEDPCB	9627-797-001	9627-797-001	9627-797-001	9627-797-001	1
*	Harness Doorlock, Switches	9627-791-004	9627-791-005	9627-791-005	9627-791-007	1
15	Spacer Plastic #6x9/16	9538-157-022	9538-157-018	9538-157-018	9538-157-018	2
16	PCB assembly Mode lights	9473-005-001	9473-005-001	9473-005-001	9473-005-001	1
17	Nut Hexkeps #6-32	8640-411-003	8640-411-003	8640-411-003	8640-411-003	2
18	Acceptor-Coin, Optical	9021-092-002	9021-092-002	9021-092-002	9021-092-002	1
19	Retainer, Coin Acceptor	9486-149-001	9486-149-001	9486-149-001	9486-149-001	2
20	Screws, Torx, T-10, 4Bx3/8ss	9545-053-002	9545-053-002	9545-053-002	9545-053-002	4
21	Switch Assembly Emergency Stop (includes wire harness)	9732-223-001	9732-223-001	9732-223-001	9732-223-001	1
22	Spacer Plastic #8x5/16 E-Stop	9538-157-020	9538-157-020	9538-157-020	9538-157-020	2
23	Plate to mount e-stop button	9452-725-001	9452-725-001	9452-725-001	9452-725-001	1
24	Nuts-Hexkeps, #8-32	8640-412-005	8640-412-005	8640-412-005	8640-412-005	3
25	Plastic Shield over main PCB	9550-184-001	9550-184-001	9550-184-001	9550-184-001	1
26	Nuts-Hexkeps, #8-32	8640-412-005	8640-412-005	8640-412-005	8640-412-005	3
27	Nameplate,Control Panel (Blue)	9412-235-002	9412-213-002	9412-207-002	9412-215-002	1
27	Nameplate,Control Panel (Black)	9412-235-001	9412-213-001	9412-207-001	9412-215-001	1
28	Motor Ass'y, Door Locking (see Door Lock Group for parts breakdown)	9892-015-001	9892-015-001	9892-015-001	9892-015-001	1
29	Nuts-Hexkeps, #8-32	8640-412-005	8640-412-005	8640-412-005	8640-412-005	4
*	Battery	8612-001-001	8612-001-001	8612-001-001	8612-001-001	1
30	Cable, USB	9806-022-001	9806-022-001	9806-022-001	9806-022-001	1
*	USB Retainer	9486-159-001	9486-159-001	9486-159-001	9486-159-001	*
31	Screw-Torx T10, #4-40x3/8ss	9545-020-004	9545-020-004	9545-020-004	9545-020-004	2
32	Nut, Spring	8640-399-008	8640-399-008	8640-399-008	8640-399-008	2

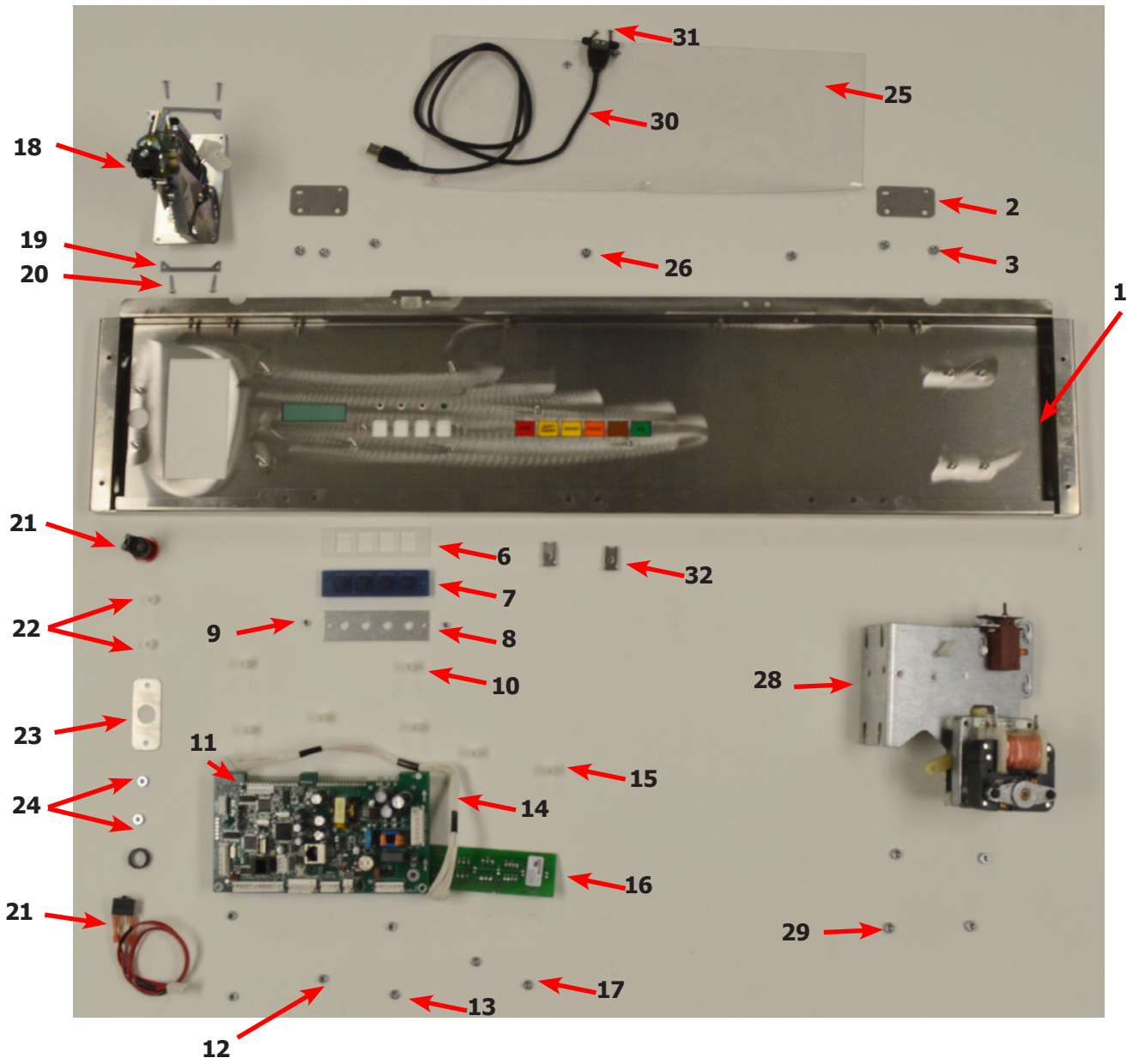

Labels and Diagrams

Key	Description	T650	T-750	T950	T1450	QTY
*	Wiring Diagram and Schematic, Coin	9506-707-001	9506-535-001	9506-537-001	9506-541-001	1
*	Transient Voltage Surge Suppressor Infomational	8507-330-001	8507-330-001	8507-330-001	8507-330-001	1
*	Label High Voltage Warning	8502-614-004	8502-614-004	8502-614-004	8502-614-004	1
*	Label Fusing & Installation	8502-619-004	8502-619-003	8502-619-003	8502-619-008	1
*	Label Quality	8511-001-002	8511-001-002	8511-001-002	8511-001-002	1
1	Label Warning Door Opening (Blue)	8502-757-002	8502-757-002	8502-757-002	8502-757-002	1
1	Label Warning Door Opening (Black)	8502-757-001	8502-757-001	8502-757-001	8502-757-001	1
2	Label Warning Risk of Injury (Blue)	8502-759-002	8502-759-002	8502-759-002	8502-759-002	1
2	Label Warning Risk of Injury (Black)	8502-759-001	8502-759-001	8502-759-001	8502-759-001	1
3	Label Dispenser (Blue)	8502-756-002	8502-756-002	8502-756-002	8502-756-002	1
3	Label Dispenser (Black)	8502-756-001	8502-756-001	8502-756-001	8502-756-001	1
*	Booklet Owners	8514-256-001	8514-229-001	8514-229-001	8514-231-001	1

1



2



3



Section 9:

Coin Handling

Parts:

Wiring Diagrams

& Schematics &

maintenance Procedures

Optical Coin Acceptor

Starting after serial# 515483

Key	Description	T650	T750	T950	Qty
1	Optical Coin Acceptor	9021-092-002	9021-092-002	9021-092-002	1
2	Replacement Optical Sensor	9801-099-001	9801-099-001	9801-099-001	1
*	Screw, Highth Bar, 3mm	9545-039-002	9545-039-002	9545-039-002	2

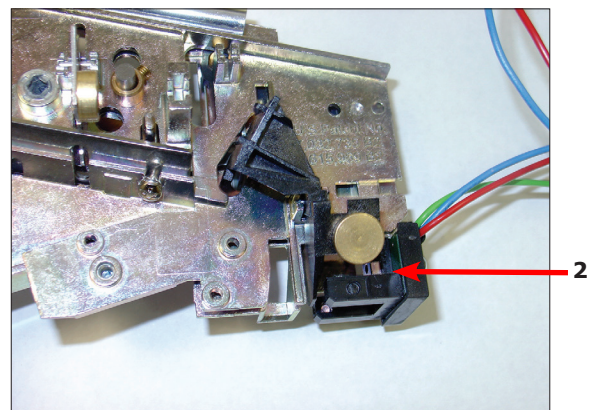
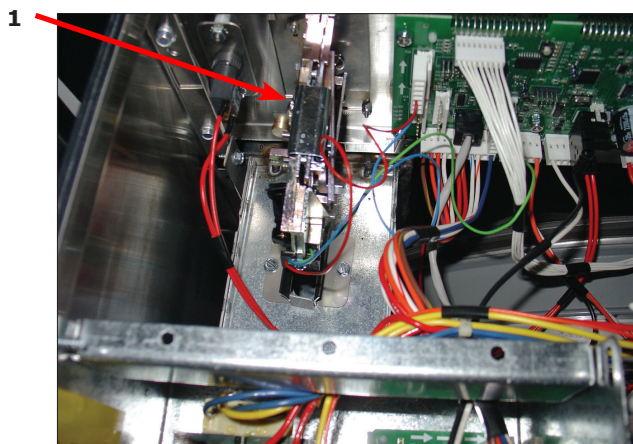
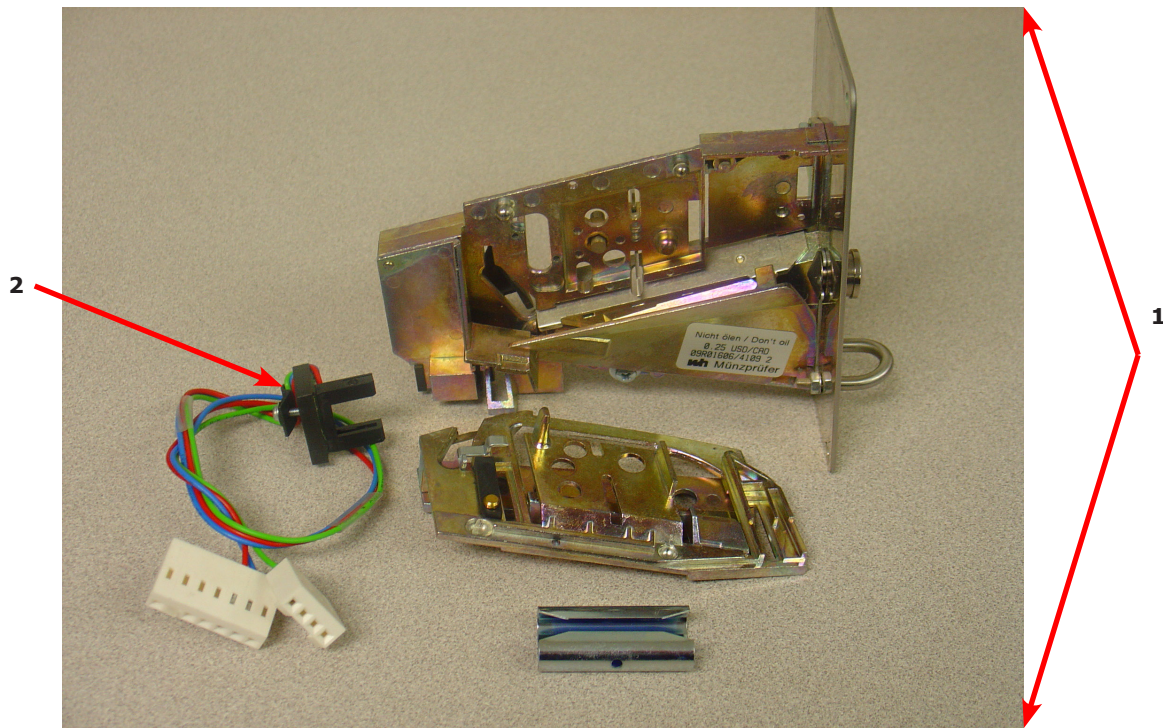

Imonex Optical Coin Acceptor

Starting after serial# 515483

Key	Description	T650	T750	T950	T1450	QTY
1	Optical Coin Acceptor				9021-034-001	1

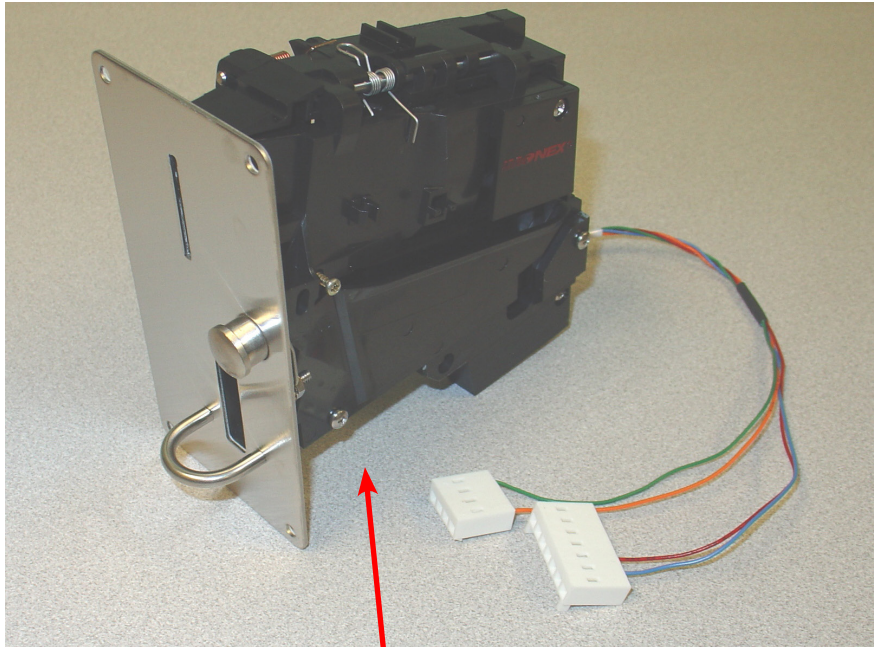

1

Kit - Electronic Acceptor Conversion for WCAD (USA and Canada)

Key	Description	T650	T750	T950	T1450	QTY
	KIT - Electronic Acceptor Conversion for WCAD (USA and Canada) Contact the Dexter Factory for Other Countries	9732-285-007	9732-285-007	9732-285-007	9732-285-007	1
1	Electronic Coin Acceptor (USA and Canada)	9021-028-001	9021-028-001	9021-028-001	9021-028-001	1
2	Harness for Electronic Coin Acceptor	9627-845-001	9627-845-001	9627-845-001	9627-845-001	1
3	Transformer 120/18VAC	8711-015-001	8711-015-001	8711-015-001	8711-015-001	1
*	Wire Assembly - Blue	8220-001-338	8220-001-338	8220-001-338	8220-001-338	1
*	Wire Assembly - Orange/White	8220-001-235	8220-001-235	8220-001-235	8220-001-235	1
4	Coin Chute for Electronic Drop	9119-028-001	9119-028-001	9119-028-001	9119-028-001	1
*	Nut - Hex Elastic Stop	8640-424-002	8640-424-002	8640-424-002	8640-424-002	1
*	Screw, Torx	9545-020-004	9545-020-004	9545-020-004	9545-020-004	4
*	Screw, Hex	9545-045-001	9545-045-001	9545-045-001	9545-045-001	4
*	Label, Informative	6102-017-001	6102-017-001	6102-017-001	6102-017-001	2
*	Label, Warning	8502-730-001	8502-730-001	8502-730-001	8502-730-001	1
*	Instructions, Installation	8507-367-001	8507-367-001	8507-367-001	8507-367-001	1
5	Coin Chute for Electronic Drop	9119-030-001	9119-030-001	9119-030-001	9119-030-001	1

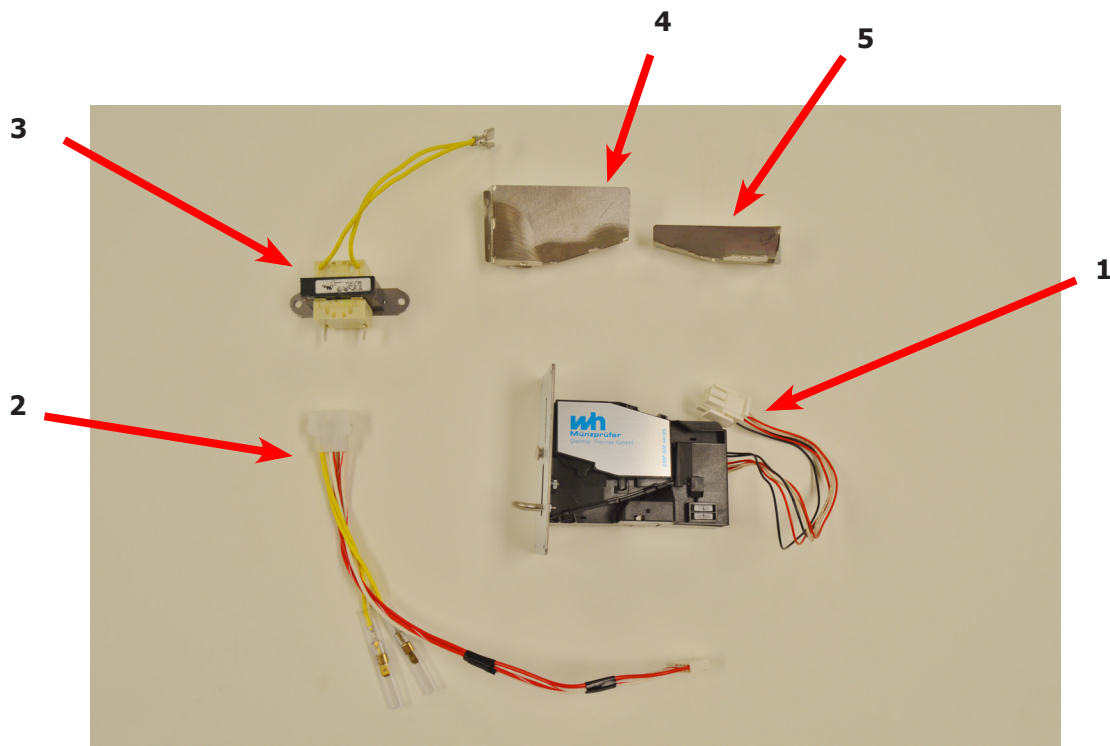

Electronic Acceptor Coin Drop

Setting the electronic coin acceptor switches

Some washer models come equipped with an electronic coin acceptor. Follow the instructions below for setting the switches for the desired country and currencies.

1. The electronic coin acceptor has switch settings depending on the coins and country. See the table below for available values of the left and right coin inputs for the available countries.

WARNING: turn power off before and leave power off when changing the switches of the electronic coin acceptor.

2. Turn power back on and test coins to ensure proper operation.

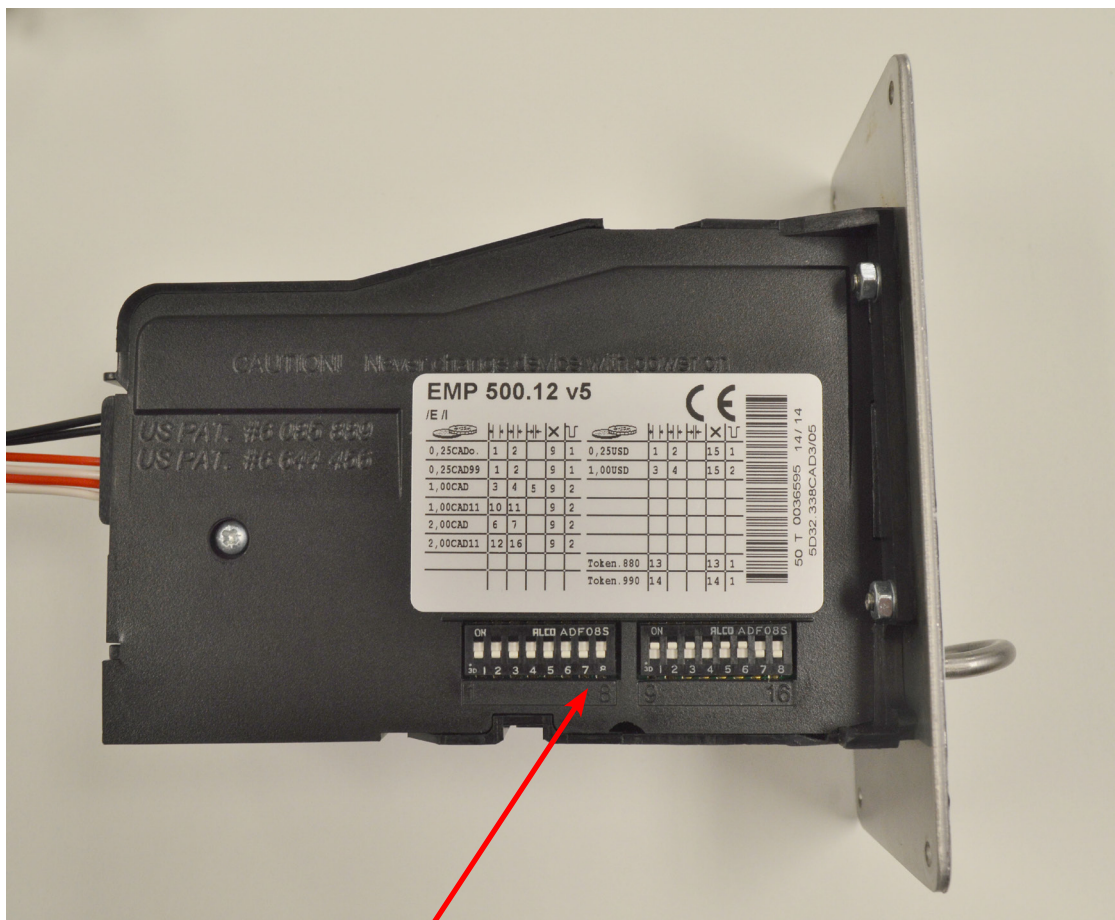

Dip Switches

Coin Acceptor Switch Settings

■ INDICATES SWITCH POSITION

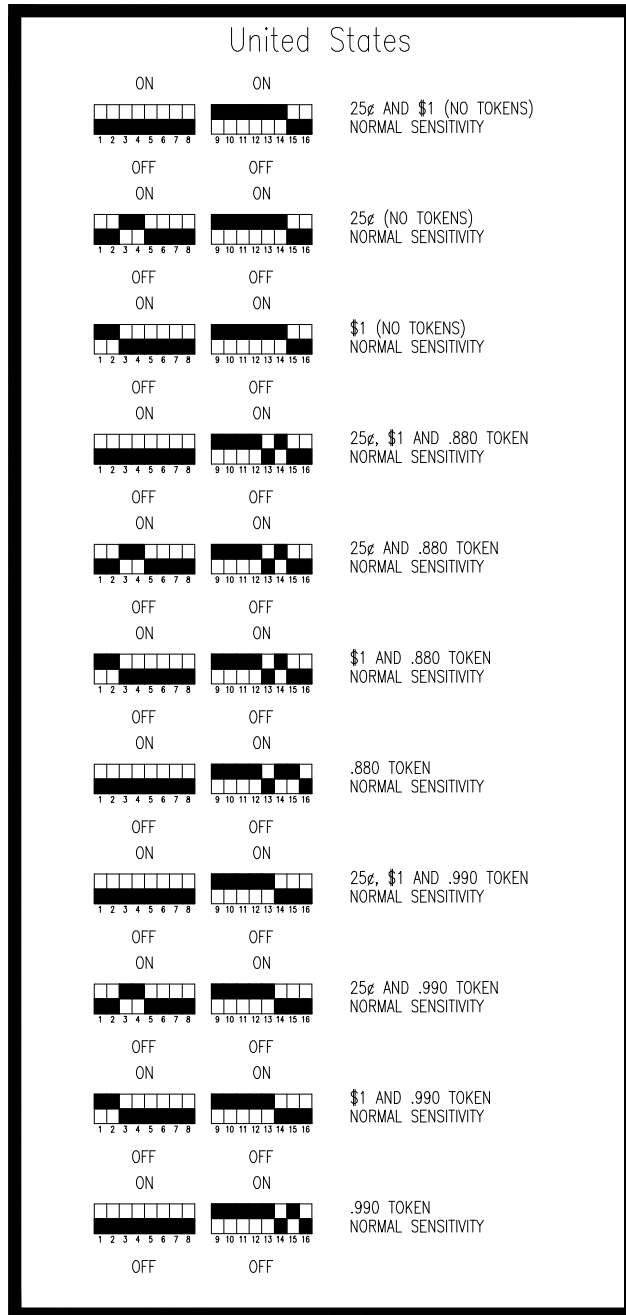

25¢ – one pulse on left washer/dryer input
 \$1 – one pulse on right washer/dryer input
 .880 TOKEN – one pulse on left washer/dryer input
 .990 TOKEN – one pulse on right washer/dryer input

Coin Acceptor Switch Settings

■ INDICATES SWITCH POSITION

Canada

ON	ON	25¢, \$1(OLD & NEW), \$2(OLD & NEW) (NO TOKENS) NORMAL SENSITIVITY
OFF	OFF	
ON	ON	\$1(OLD & NEW) AND \$2(OLD & NEW) (NO TOKENS) NORMAL SENSITIVITY
OFF	OFF	
ON	ON	25¢ AND \$2(OLD & NEW) (NO TOKENS) NORMAL SENSITIVITY
OFF	OFF	
ON	ON	25¢ AND \$1(OLD & NEW) (NO TOKENS) NORMAL SENSITIVITY
OFF	OFF	
ON	ON	25¢ (NO TOKENS) NORMAL SENSITIVITY
OFF	OFF	
ON	ON	\$2(OLD & NEW) (NO TOKENS) NORMAL SENSITIVITY
OFF	OFF	
ON	ON	\$1(OLD & NEW) (NO TOKENS) NORMAL SENSITIVITY
OFF	OFF	
ON	ON	25¢, \$1(NEW ONLY), \$2(NEW ONLY) (NO TOKENS) NORMAL SENSITIVITY
OFF	OFF	
ON	ON	\$1(NEW ONLY) AND \$2(NEW ONLY) (NO TOKENS) NORMAL SENSITIVITY
OFF	OFF	
ON	ON	25¢ AND \$2(NEW ONLY) (NO TOKENS) NORMAL SENSITIVITY
OFF	OFF	
ON	ON	25¢ AND \$1(NEW ONLY) (NO TOKENS) NORMAL SENSITIVITY
OFF	OFF	
ON	ON	\$2(NEW ONLY) (NO TOKENS) NORMAL SENSITIVITY
OFF	OFF	
ON	ON	\$1(NEW ONLY) (NO TOKENS) NORMAL SENSITIVITY
OFF	OFF	

Canada

ON	ON	25¢, \$1(OLD & NEW), \$2(OLD & NEW) AND .880 TOKEN NORMAL SENSITIVITY
OFF	OFF	
ON	ON	\$1(OLD & NEW), \$2(OLD & NEW) AND .880 TOKEN NORMAL SENSITIVITY
OFF	OFF	
ON	ON	25¢, \$2(OLD & NEW) AND .880 TOKEN NORMAL SENSITIVITY
OFF	OFF	
ON	ON	25¢, \$1(OLD & NEW) AND .880 TOKEN NORMAL SENSITIVITY
OFF	OFF	
ON	ON	25¢ AND .880 TOKEN NORMAL SENSITIVITY
OFF	OFF	
ON	ON	\$2(OLD & NEW) AND .880 TOKEN NORMAL SENSITIVITY
OFF	OFF	
ON	ON	\$1(OLD & NEW) AND .880 TOKEN NORMAL SENSITIVITY
OFF	OFF	
ON	ON	25¢, \$1(NEW ONLY), \$2(NEW ONLY) AND .880 TOKEN NORMAL SENSITIVITY
OFF	OFF	
ON	ON	\$1(NEW ONLY), \$2(NEW ONLY) AND .880 TOKEN NORMAL SENSITIVITY
OFF	OFF	
ON	ON	25¢, \$2(NEW ONLY) AND .880 TOKEN NORMAL SENSITIVITY
OFF	OFF	
ON	ON	25¢, \$1(NEW ONLY) AND .880 TOKEN NORMAL SENSITIVITY
OFF	OFF	
ON	ON	\$2(NEW ONLY) AND .880 TOKEN NORMAL SENSITIVITY
OFF	OFF	
ON	ON	\$1(NEW ONLY) AND .880 TOKEN NORMAL SENSITIVITY
OFF	OFF	

- 25¢ – one pulse on left washer/dryer input
- \$1 – one pulse on right washer/dryer input
- \$2 – two pulses on right washer/dryer input
- .880 TOKEN – one pulse on right washer/dryer input
- .990 TOKEN – one pulse on right washer/dryer input

Coin Acceptor Switch Settings

■ INDICATES SWITCH POSITION

Canada

ON	ON	25¢, \$1(OLD & NEW), \$2(OLD & NEW) AND .990 TOKEN NORMAL SENSITIVITY
OFF	OFF	
ON	ON	
		\$1(OLD & NEW), \$2(OLD & NEW) AND .990 TOKEN NORMAL SENSITIVITY
OFF	OFF	
ON	ON	
		25¢, \$2(OLD & NEW) AND .990 TOKEN NORMAL SENSITIVITY
OFF	OFF	
ON	ON	
		25¢, \$1(OLD & NEW) AND .990 TOKEN NORMAL SENSITIVITY
OFF	OFF	
ON	ON	
		25¢ AND .990 TOKEN NORMAL SENSITIVITY
OFF	OFF	
ON	ON	
		\$2(OLD & NEW) AND .990 TOKEN NORMAL SENSITIVITY
OFF	OFF	
ON	ON	
		\$1(OLD & NEW) AND .990 TOKEN NORMAL SENSITIVITY
OFF	OFF	
ON	ON	
		25¢, \$1(NEW ONLY), \$2(NEW ONLY) AND .990 TOKEN NORMAL SENSITIVITY
OFF	OFF	
ON	ON	
		\$1(NEW ONLY), \$2(NEW ONLY) AND .990 TOKEN NORMAL SENSITIVITY
OFF	OFF	
ON	ON	
		25¢, \$2(NEW ONLY) AND .990 TOKEN NORMAL SENSITIVITY
OFF	OFF	
ON	ON	
		25¢, \$1(NEW ONLY) AND .990 TOKEN NORMAL SENSITIVITY
OFF	OFF	
ON	ON	
		\$2(NEW ONLY) AND .990 TOKEN NORMAL SENSITIVITY
OFF	OFF	
ON	ON	
		\$1(NEW ONLY) AND .990 TOKEN NORMAL SENSITIVITY
OFF	OFF	

Canada

ON	ON	25¢, \$1(OLD & NEW), \$2(OLD & NEW), .880 AND .990 TOKEN NORMAL SENSITIVITY
OFF	OFF	
ON	ON	
		\$1(OLD & NEW), \$2(OLD & NEW), .880 AND .990 TOKEN NORMAL SENSITIVITY
OFF	OFF	
ON	ON	
		25¢, \$2(OLD & NEW), .880 AND .990 TOKEN NORMAL SENSITIVITY
OFF	OFF	
ON	ON	
		25¢, \$1(OLD & NEW), .880 AND .990 TOKEN NORMAL SENSITIVITY
OFF	OFF	
ON	ON	
		25¢, .880 AND .990 TOKEN NORMAL SENSITIVITY
OFF	OFF	
ON	ON	
		\$2(OLD & NEW), .880 AND .990 TOKEN NORMAL SENSITIVITY
OFF	OFF	
ON	ON	
		\$1(OLD & NEW), .880 AND .990 TOKEN NORMAL SENSITIVITY
OFF	OFF	
ON	ON	
		25¢, \$1(NEW ONLY), \$2(NEW ONLY), .880 AND .990 TOKEN NORMAL SENSITIVITY
OFF	OFF	
ON	ON	
		\$1(NEW ONLY), \$2(NEW ONLY), .880 AND .990 TOKEN NORMAL SENSITIVITY
OFF	OFF	
ON	ON	
		25¢, \$2(NEW ONLY), .880 AND .990 TOKEN NORMAL SENSITIVITY
OFF	OFF	
ON	ON	
		25¢, \$1(NEW ONLY), .880 AND .990 TOKEN NORMAL SENSITIVITY
OFF	OFF	
ON	ON	
		\$2(NEW ONLY), .880 AND .990 TOKEN NORMAL SENSITIVITY
OFF	OFF	
ON	ON	
		\$1(NEW ONLY), .880 AND .990 TOKEN NORMAL SENSITIVITY
OFF	OFF	

25¢ – one pulse on left washer/dryer input
 \$1 – one pulse on right washer/dryer input
 \$2 – two pulses on right washer/dryer input
 .880 TOKEN – one pulse on right washer/dryer input
 .990 TOKEN – one pulse on right washer/dryer input

Maintenance Instructions

Electronic Acceptor

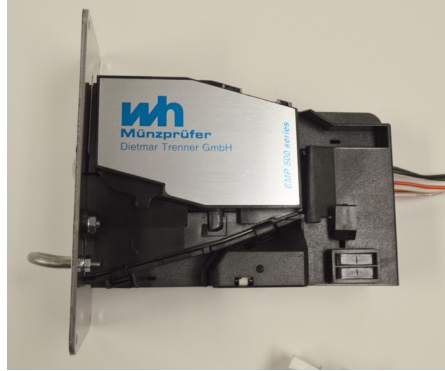

Cleaning the electronic coin selector

The EMP 500 v5 is an extraordinarily robust coin selector and operates relatively maintenance free. However, it should be cleaned at regular intervals (minimum once a year) especially if it is operating in an environment with high levels of dust, smoke or nicotine. The cleaning intervals are of course dependent on the level of air borne contaminants.

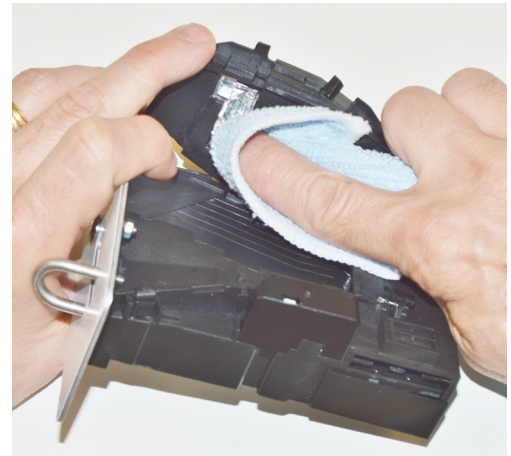
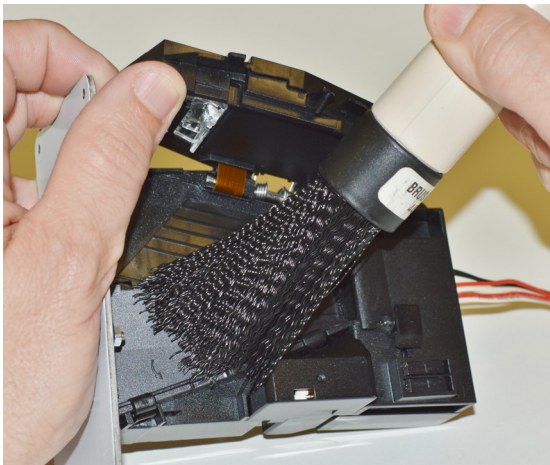

Clean the coin path with soft brush and wipe the exposed surfaces. Use an alcohol moistened cloth. If you find solid residues stuck to the coin rail remove it with an alcohol moistened cloth.



Optical sensors may be cleaned with a soft brush very carefully with an air spray duster.

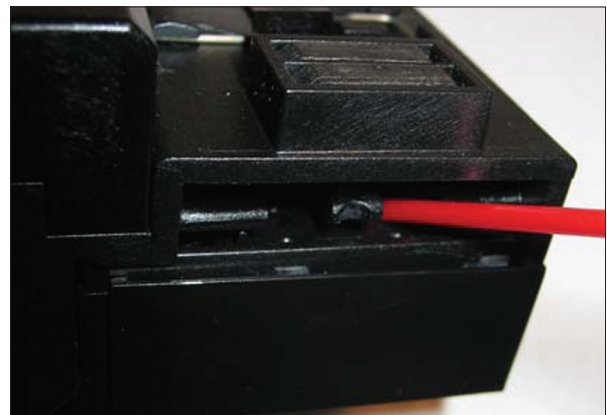

Location of the optical sensor within coin outlet.

T650 Express Vended Schematic

208-240V-3PH OR 1PH-60HZ

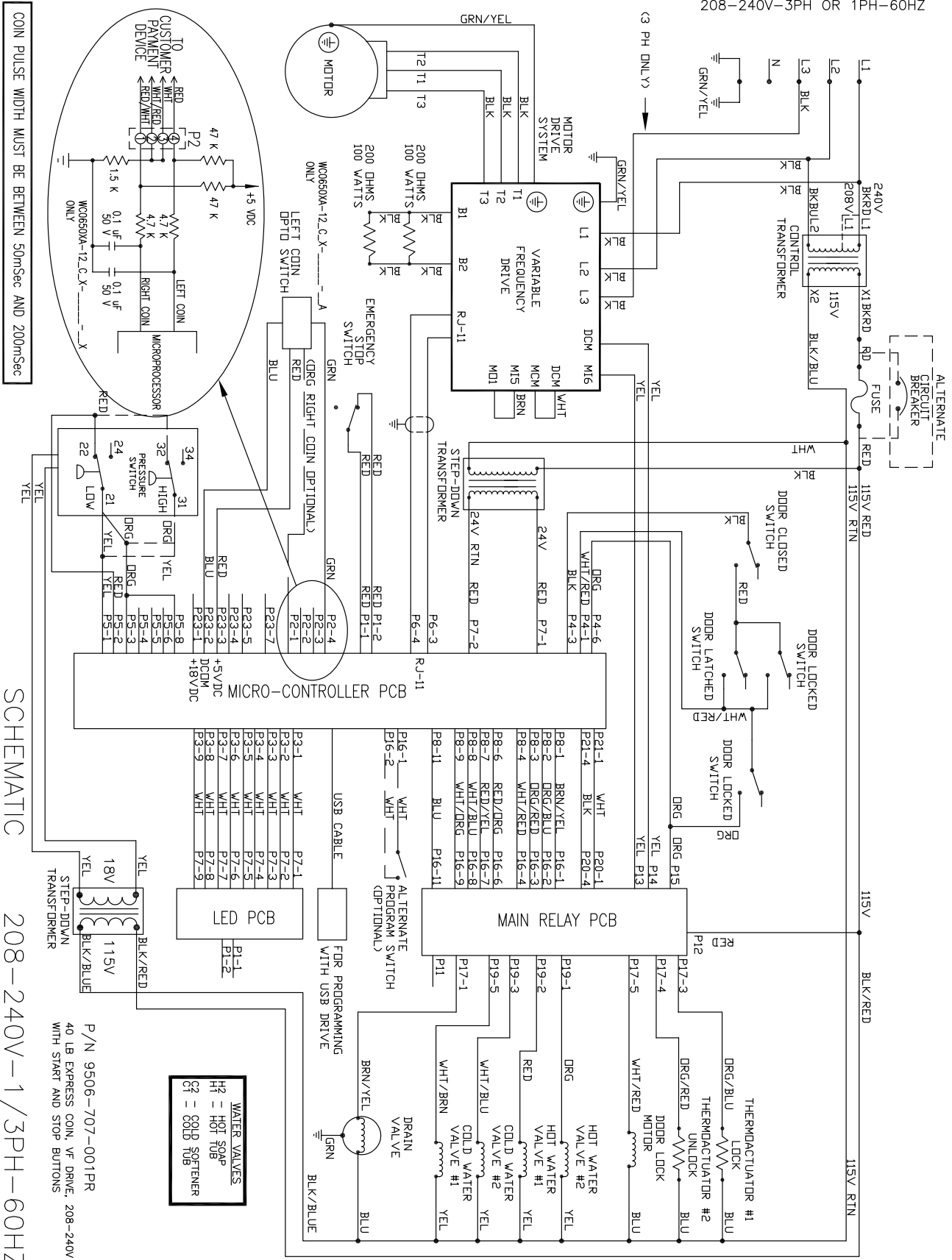

SCHEMATIC

208-240V-1/3PH-60HZ

COIN PULSE WIDTH MUST BE BETWEEN 50mSec AND 200mSec

WATER VALVES
 H2 = HOT SOAP
 H1 = HOT TUB
 C2 = COLD SOFTENER
 C1 = COLD TUB

P/N 9506-707-001PR
 40 LB EXPRESS COIN, VF DRIVE, 208-240V
 WITH START AND STOP BUTTONS

T650 Express Vended Diagram

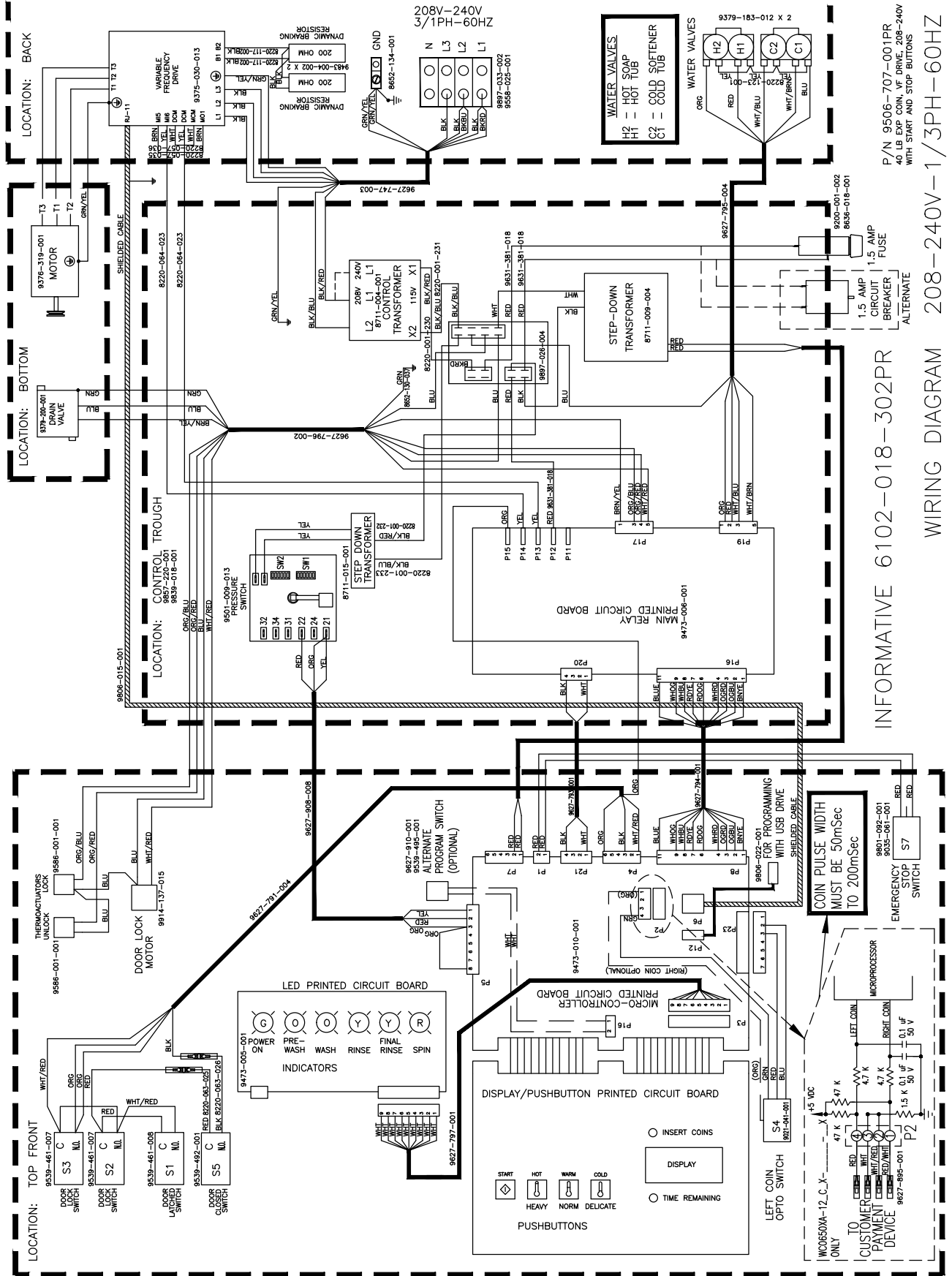

INFORMATIVE 6102-018-302PR

P/N 9506-707-001PR
40 LB EXP COIN V.F. DRIVE, 208-240V
WITH START AND STOP BUTTONS

WIRING DIAGRAM 208-240V-1/3PH-60HZ

T750 Express Vended Diagram

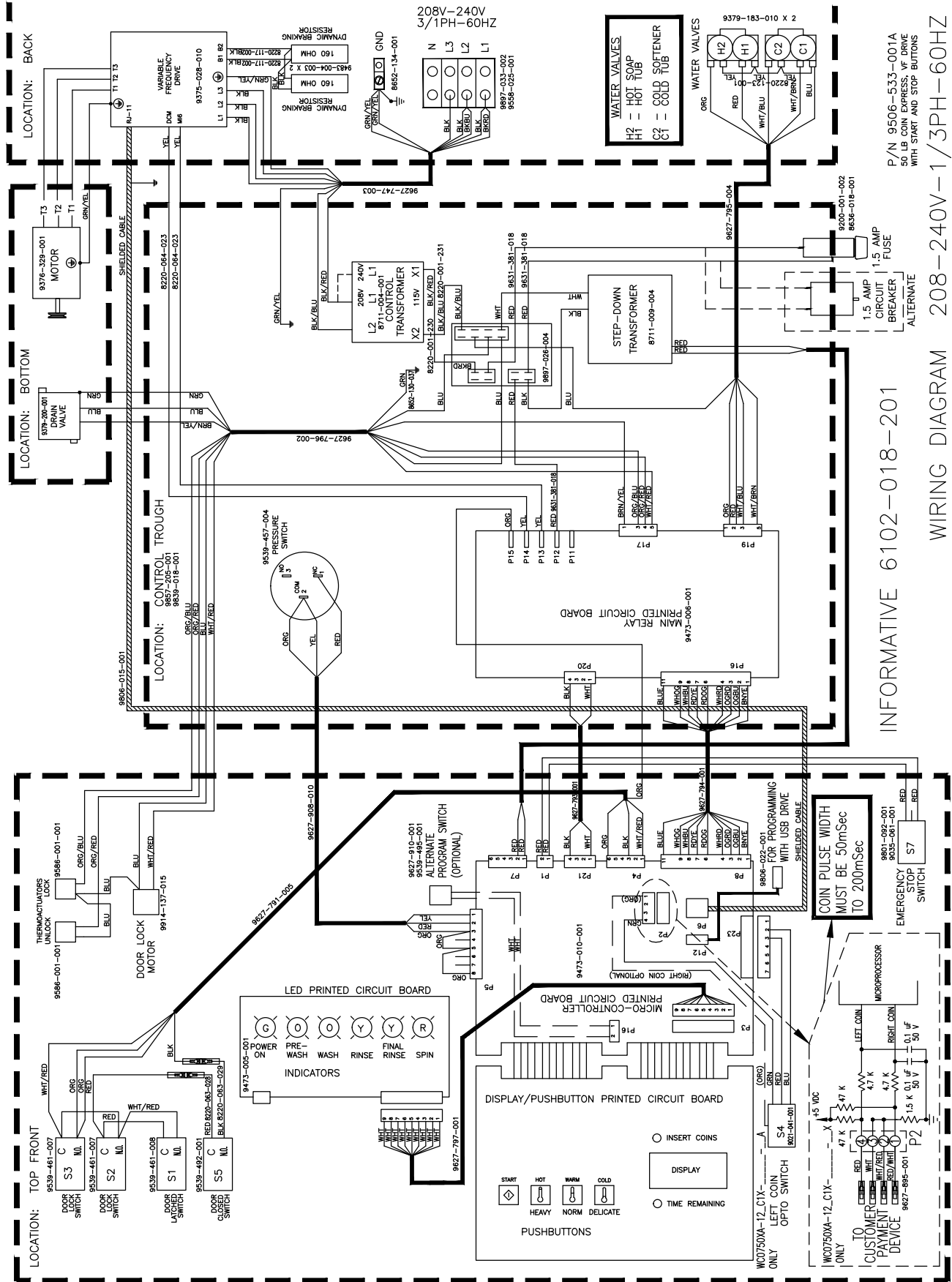

T950 Express Vended Schematic

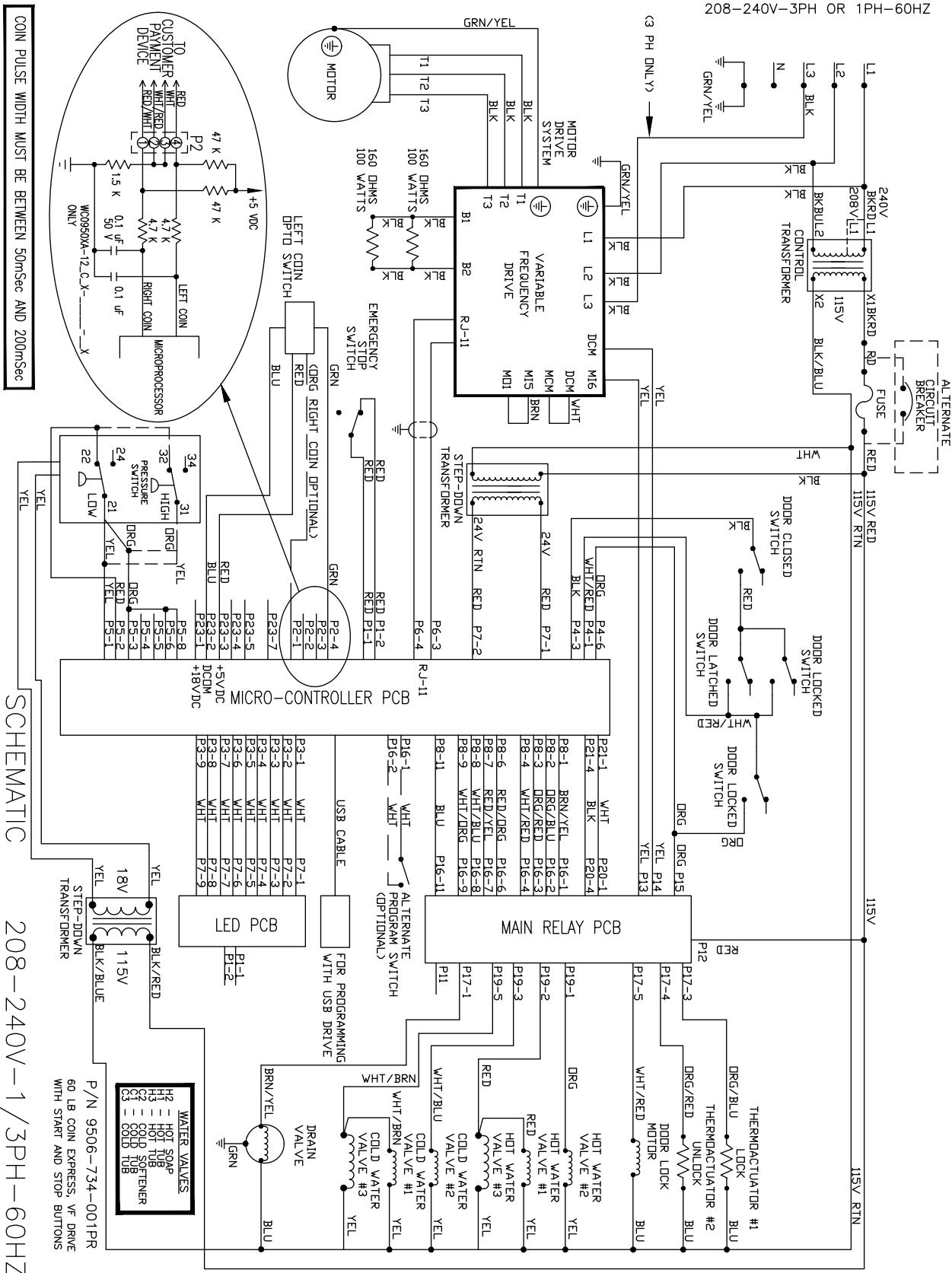

SCHEMATIC

208-240V-1/3PH-60HZ

COIN PULSE WIDTH MUST BE BETWEEN 50mSec AND 200mSec

T950 Express Vended Diagram

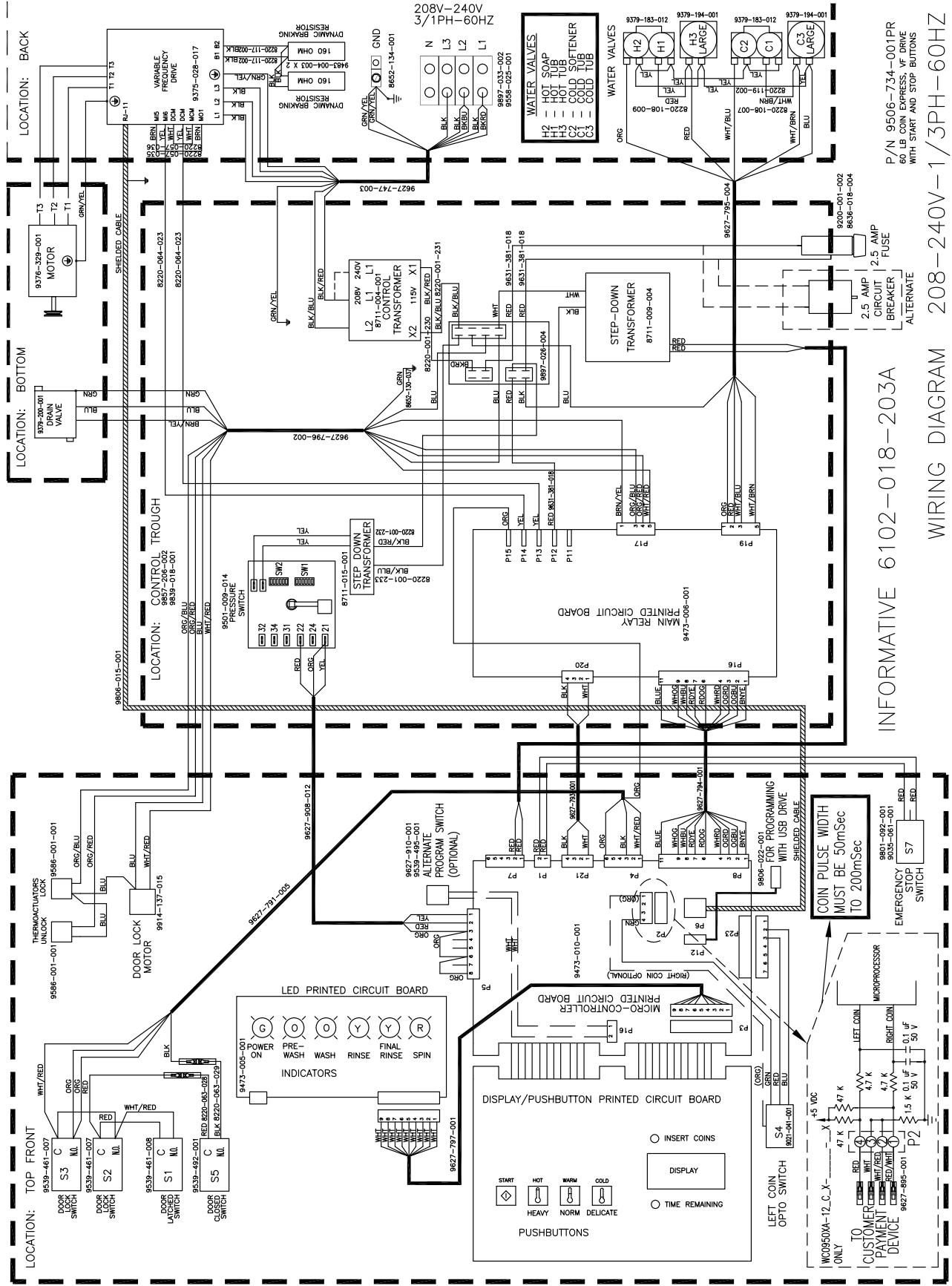

P/N 9506-734-001PR
60 LB COIN EXPRESS VENDOR
WITH START AND STOP BUTTONS

INFORMATIVE 6102-018-203A

WIRING DIAGRAM 208-240V-1/3PH-60HZ

T1450 Express Vended Diagram

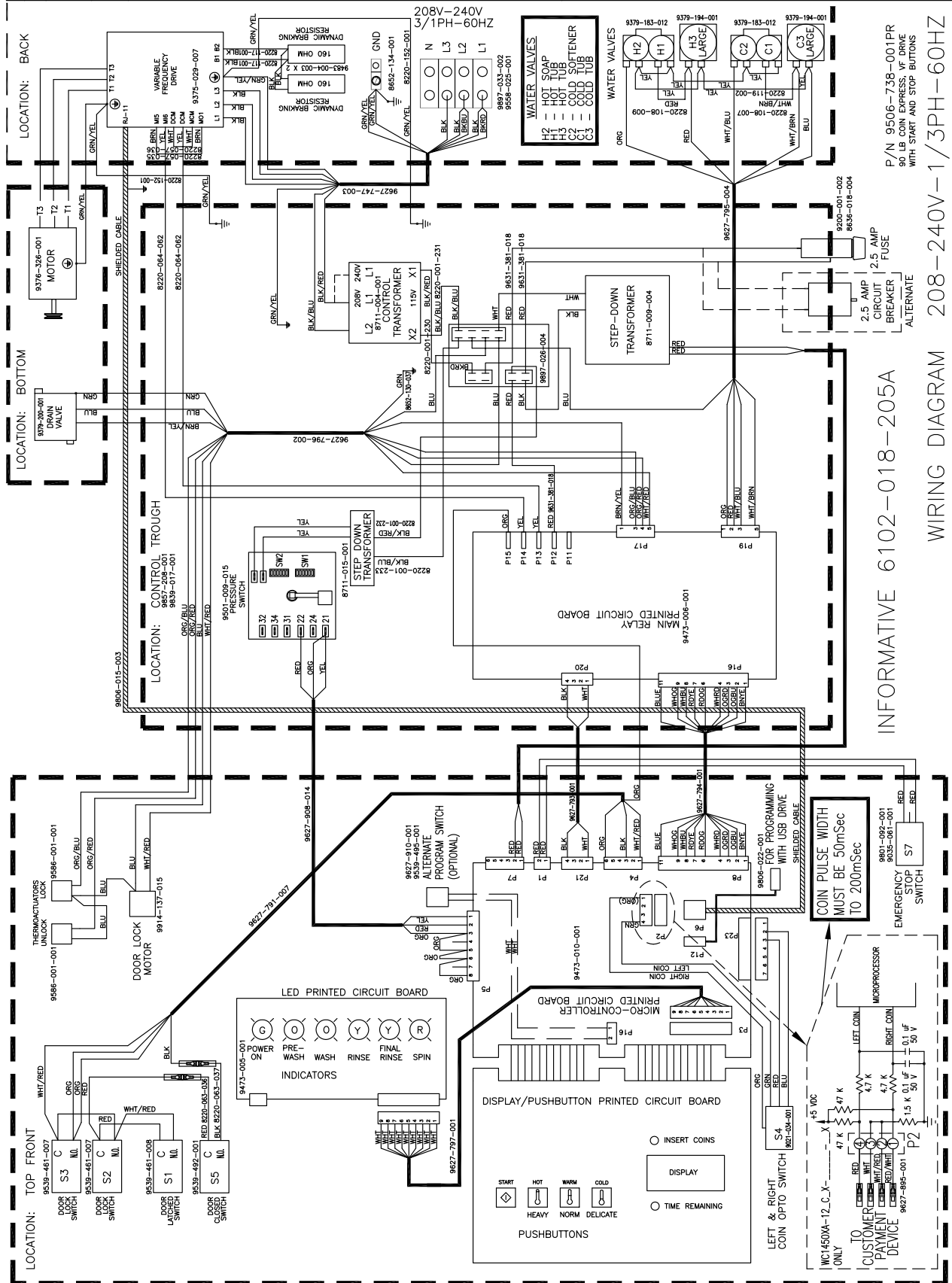

INFORMATIVE 6102-018-205A

WIRING DIAGRAM 208-240V-1/3PH-60HZ

P/N 9506-738-001PR
90 LB COIN EXPRESS: W/ DRIVE
WITH START AND STOP BUTTONS

COIN PULSE WIDTH
MUST BE 50mSec
TO 200mSec

EMERGENCY
STOP SWITCH

TO
CUSTOMER
PAYMENT
DEVICE

45 VDC

Section :10

Parts 50Hz

Models:

Parts in this section used only in these models. All other parts are same as standard 60 Hz pages.

Wiring Diagrams & Schematics

Transformer, Electrical -39 models

WC0750-XA39ECX	230 volts	50hz	Single Phase
WC0900-XA39ECX	230 volts	50hz.	Single Phase
WC0950-XA39ECX	230 volts	50hz.	Single Phase
WC01200-XA39ECX	230 volts	50hz	Single Phase
WC01450-XA39ECX	230 volts	50hz	Single Phase

Key	Component	T650	T750	T950	T1450	QTY
1	Circuit Breaker	5198-211-002	5198-211-002	5198-211-002	5198-211-002	1
*	Instructions, Transformer Connect	8507-449-002	8507-449-002	8507-449-002	8507-449-002	1
*	Manual-Opeators	8514-228-002	8514-			1
2	Controls Transformer, 200/250-24V 50Hz.	8711-004-003	8711-004-003	8711-004-003	8711-004-003	1
	Water Valve	9379-183-013	9379-183-013	9379-183-013	9379-183-013	2
	Diaphragm Invensys (EPDM)	9118-049-001	9118-049-001	9118-049-001	9118-049-001	2
	Diaphragm Invensys (Viton)	9118-049-002	9118-049-002	9118-049-002	9118-049-002	2
	Water Valve Single			9379-194-003	9379-194-003	2
	Diaphragm Mueller			9118-055-001	9118-055-001	1
	Wiring Label , Schematic & Diagram	9506-534-001	9506-536-001	9506-538-001	9506-541-001	1
	Wiring Harness, Power Terminal Block	9627-747-006	9627-747-006	9627-747-006	9627-747-006	1
	Wiring Harness Main, 1.5	9627-914-001	9627-914-001	9627-914-001	9627-914-001	1
	Hose Assembly, Inlet	9990-027-014				

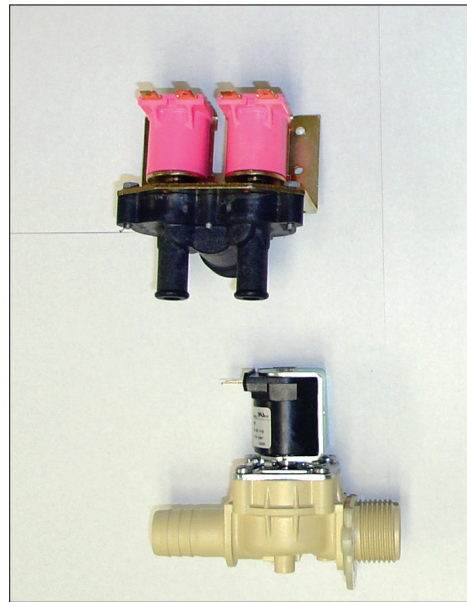
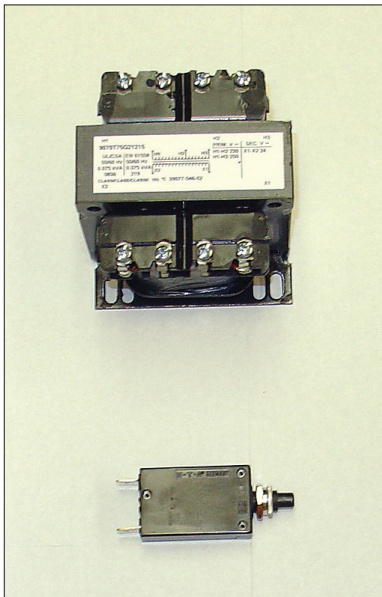

Drain Valve Group 50 HZ

Key	Description	Part Number	Qty
1	Valve, Drain (includes #2 thru #11)	9379-202-002	1
2	Body, Valve (w/ball)	9064-072-001	1
3	Motor & Gear Train (complete)	9914-137-022	1
4	Plate, Motor Mtg	9452-538-001	1
5	Screw	8639-994-001	1
6	Spring, Drive	9534-339-001	1
7	Screw	9545-054-001	1
8	Screw	9545-054-002	1
9	Seal, V Packer	9532-134-001	1
10	Washer	8641-584-001	1
11	Pin, Main Drive	9451-196-001	1
*	Plate (spacers needed for replacement motor mtg. plate)	9538-149-001	1
12	Kit - Seal Replacement	9732-327-001	1

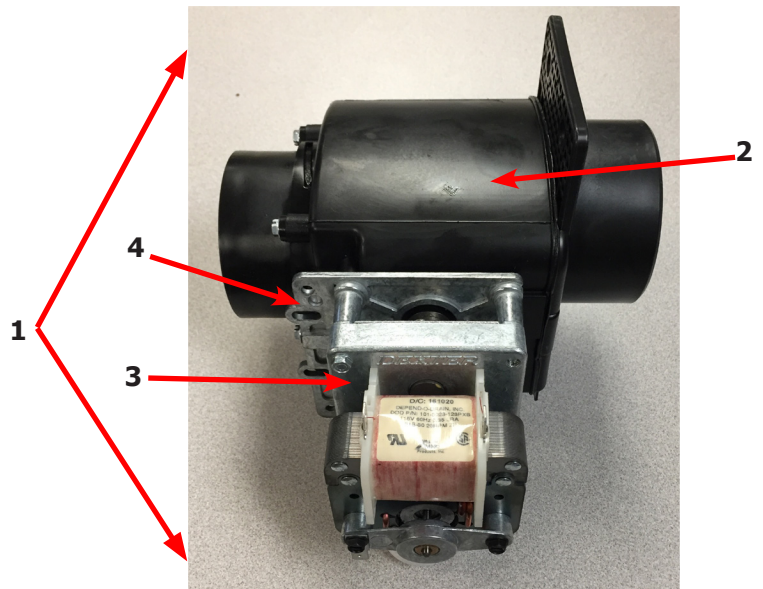
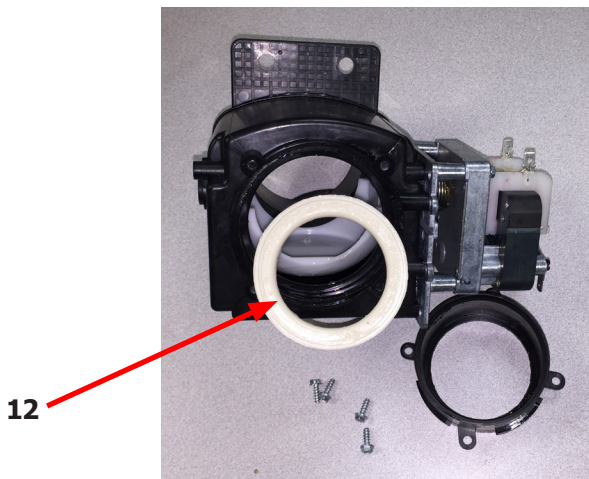

9, 10, 11

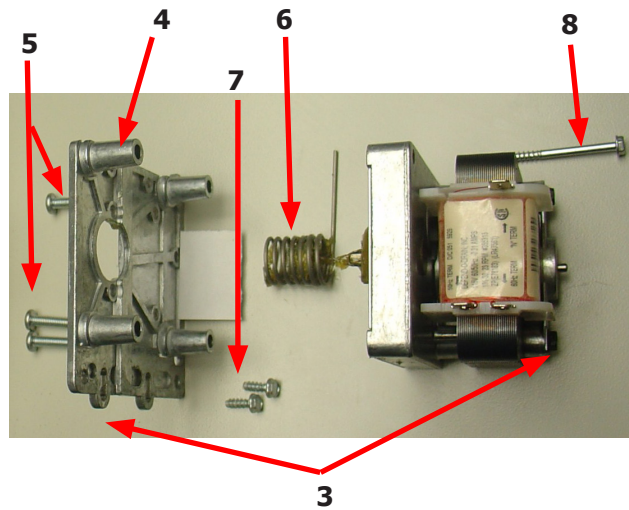

Door Lock Motor Assy # by Model 50Hz.

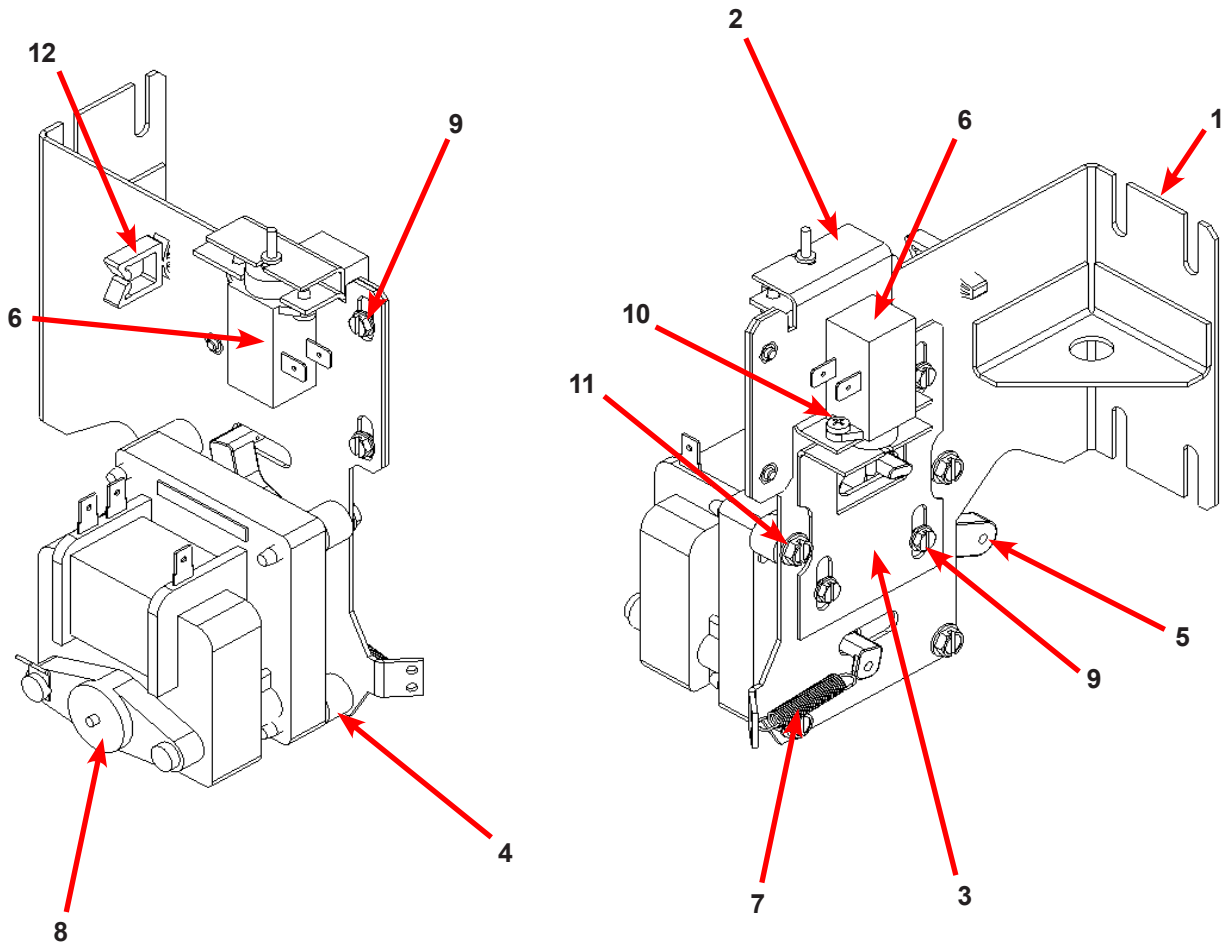

Key	Description	T650	T750	T950	T1450	QTY
*	Actuator Assembly (Includes 1-10, Rod NOT included)	9892-015-002	9892-015-002	9892-015-002	9892-015-002	1
1	Bracket Assy, Slide Lock Actuator	9985-190-001	9985-190-001	9985-190-001	9985-190-001	1
2	Bracket Assy, Slide - Unlock	9985-189-001	9985-189-001	9985-189-001	9985-189-001	1
3	Bracket Slide Lock	9029-204-001	9029-204-001	9029-204-001	9029-204-001	1
4	Spacer, Plastic	9538-157-021	9538-157-021	9538-157-021	9538-157-021	4
5	Arm - Door Lock	9001-063-001	9001-063-001	9001-063-001	9001-063-001	1
6	Thermoactuator - Door Lock Relay 24V	9586-001-003	9586-001-003	9586-001-003	9586-001-003	2
7	Spring - Extension	9534-350-001	9534-350-001	9534-350-001	9534-350-001	1
8	Motor & Gear Assembly 24V	9914-137-014	9914-137-014	9914-137-014	9914-137-014	1
9	Screw -HxwshrhdsIsems, 6-32 x 3/16	9545-044-003	9545-044-003	9545-044-003	9545-044-003	6
10	Cross Recessed PAn Hd Tapping screw	9545-031-011	9545-031-011	9545-031-011	9545-031-011	4
11	Screw Pnhdcr, 10-32 UNFx0 .75	9545-012-027	9545-012-027	9545-012-027	9545-012-027	4
12	Standoff-Wire Saddle	9527-007-001	9527-007-001	9527-007-001	9527-007-001	1
*	Rod, Door Lock	9497-225-	9497-225-013	9497-225-015	9497-225-016	1
*	Harness, Door Lock/Drain, P17	9627-796-001	9627-796-001	9627-796-001	9627-796-001	1

T650 230/50/1 Voltage Schematic

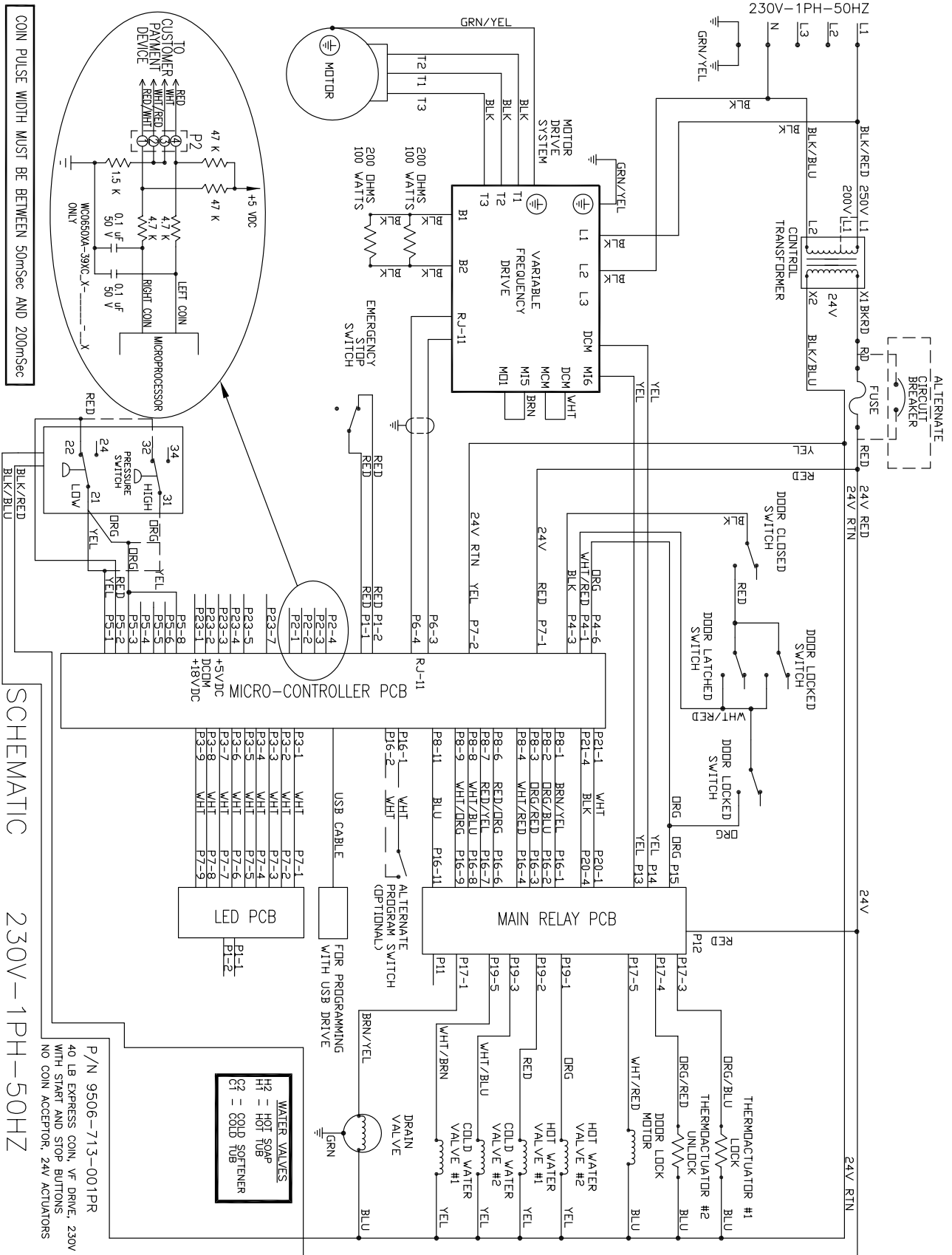

T650 230/50/1 Voltage Diagram

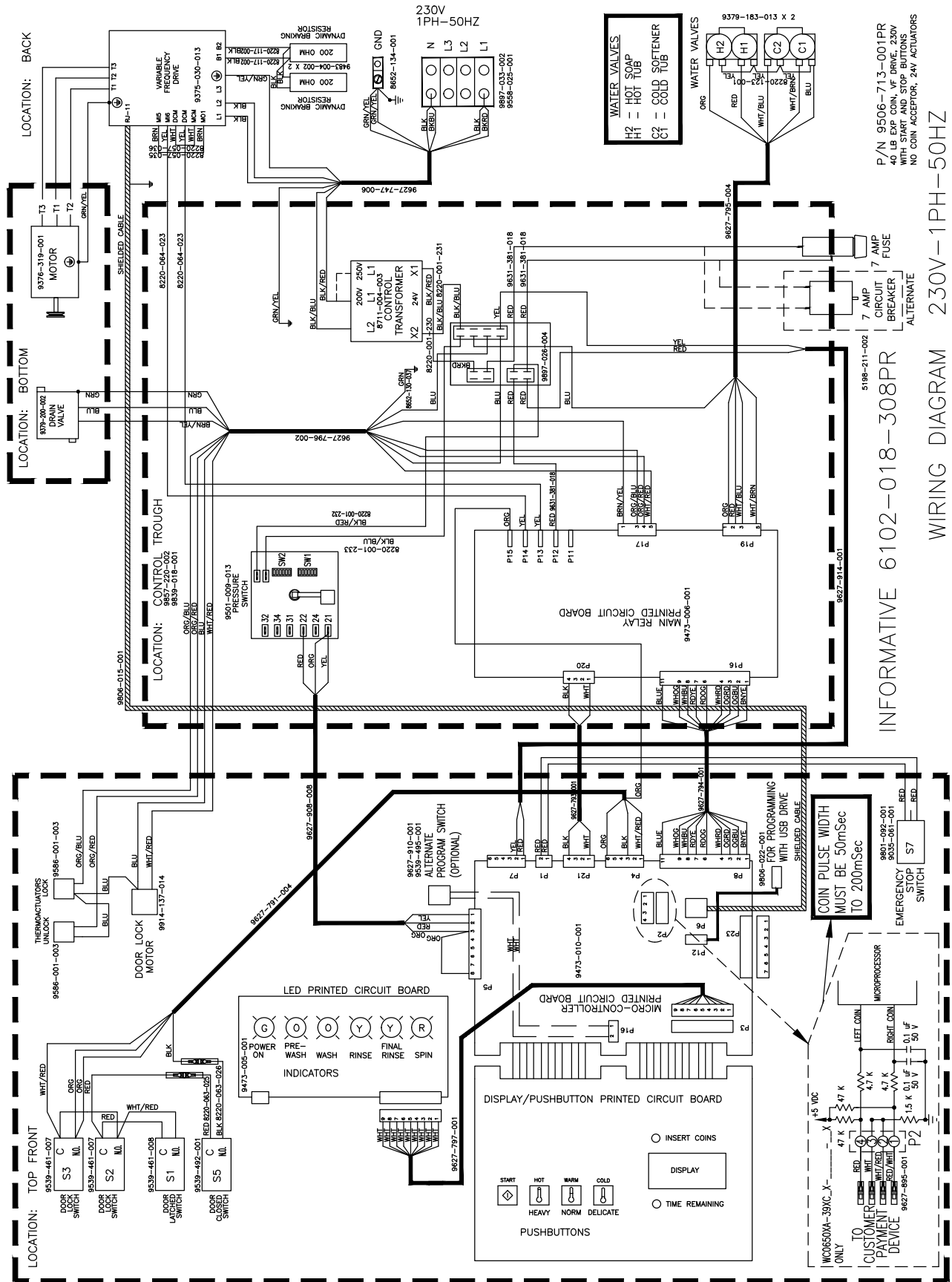

P/N 9506-713-001PR
40 LB EXP COIN, V.F. DRIVE 230V
WITH START AND STOP BUTTONS
NO COIN ACCEPTOR, 24V ACTUATORS

INFORMATIVE 6102-018-308PR

WIRING DIAGRAM 230V-1PH-50HZ

COIN PULSE WIDTH
MUST BE 50mSec
TO 200mSec

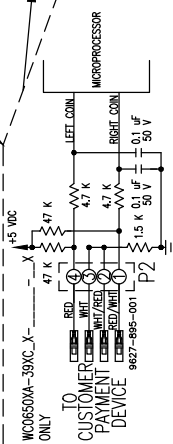

T750 230/50/1 Voltage Schematic

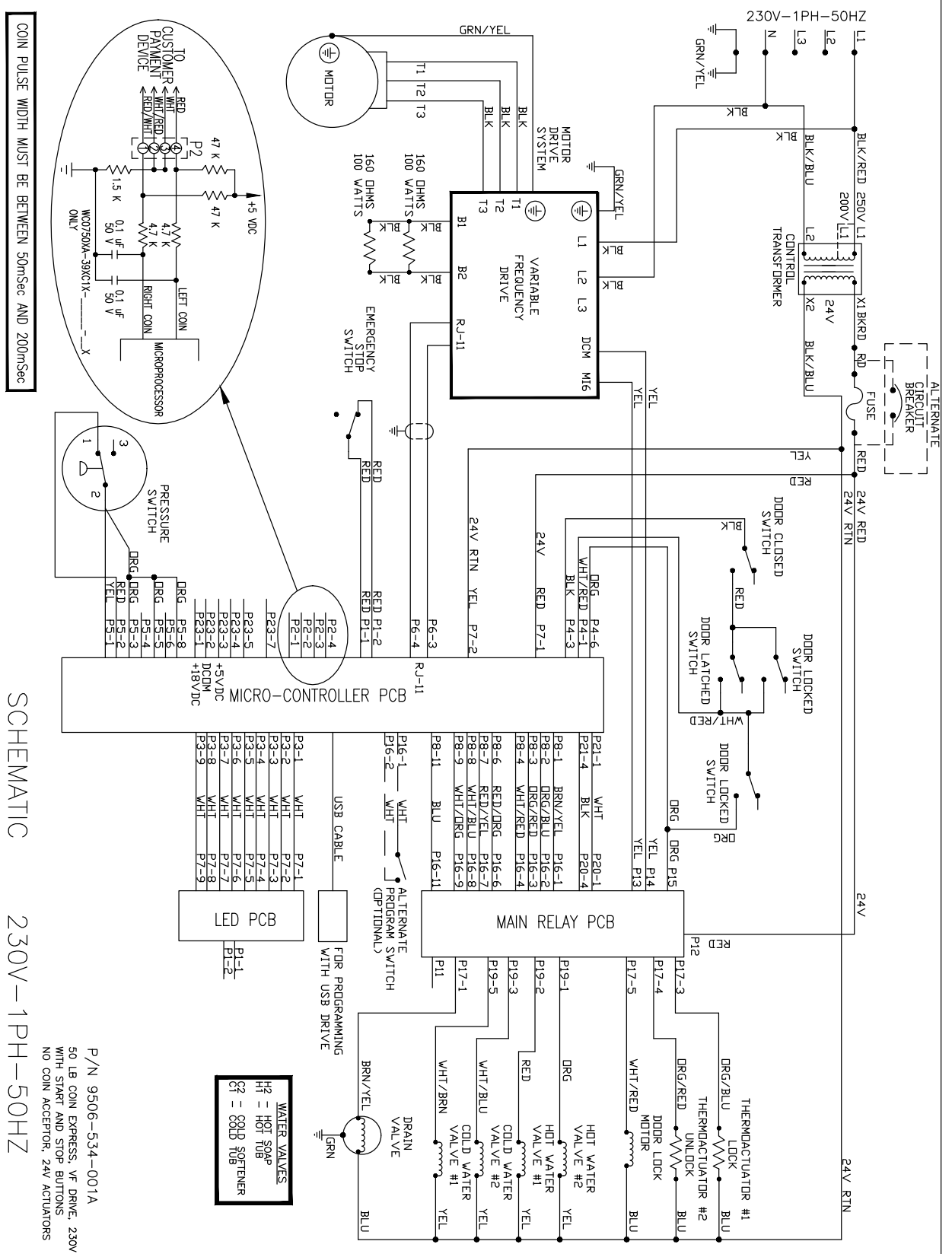

T750 230V/50/1 Voltage Diagram

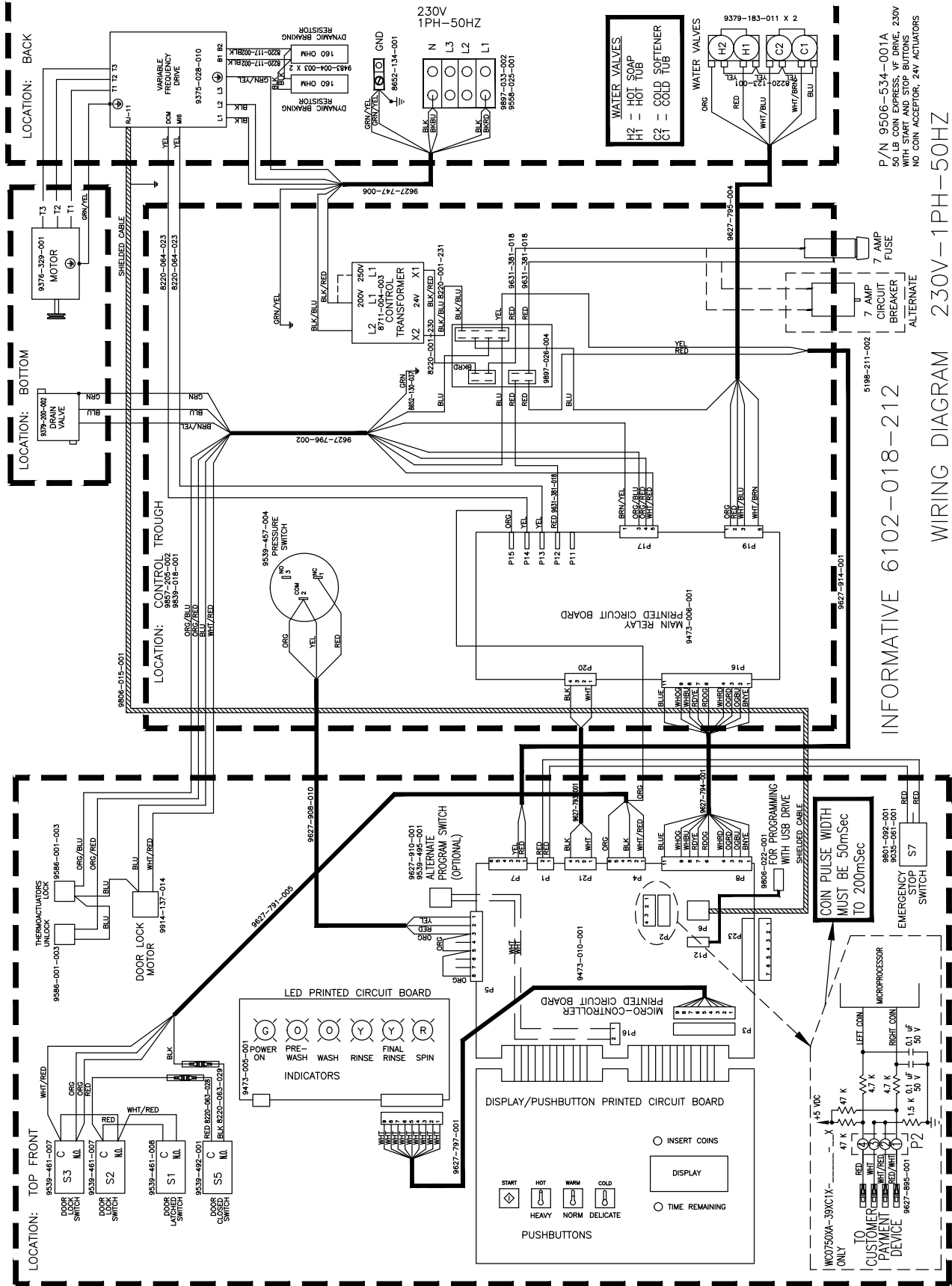

P/N 9506-534-001A
54 LB COIN EXPRESS V6 DRIVE 230V
WITH START AND STOP BUTTONS
NO COIN ACCEPTOR, 24V ACTUATORS

INFORMATIVE 6102-018-212

WIRING DIAGRAM 230V-1PH-50HZ

T950 230/50/1 Voltage Schematic

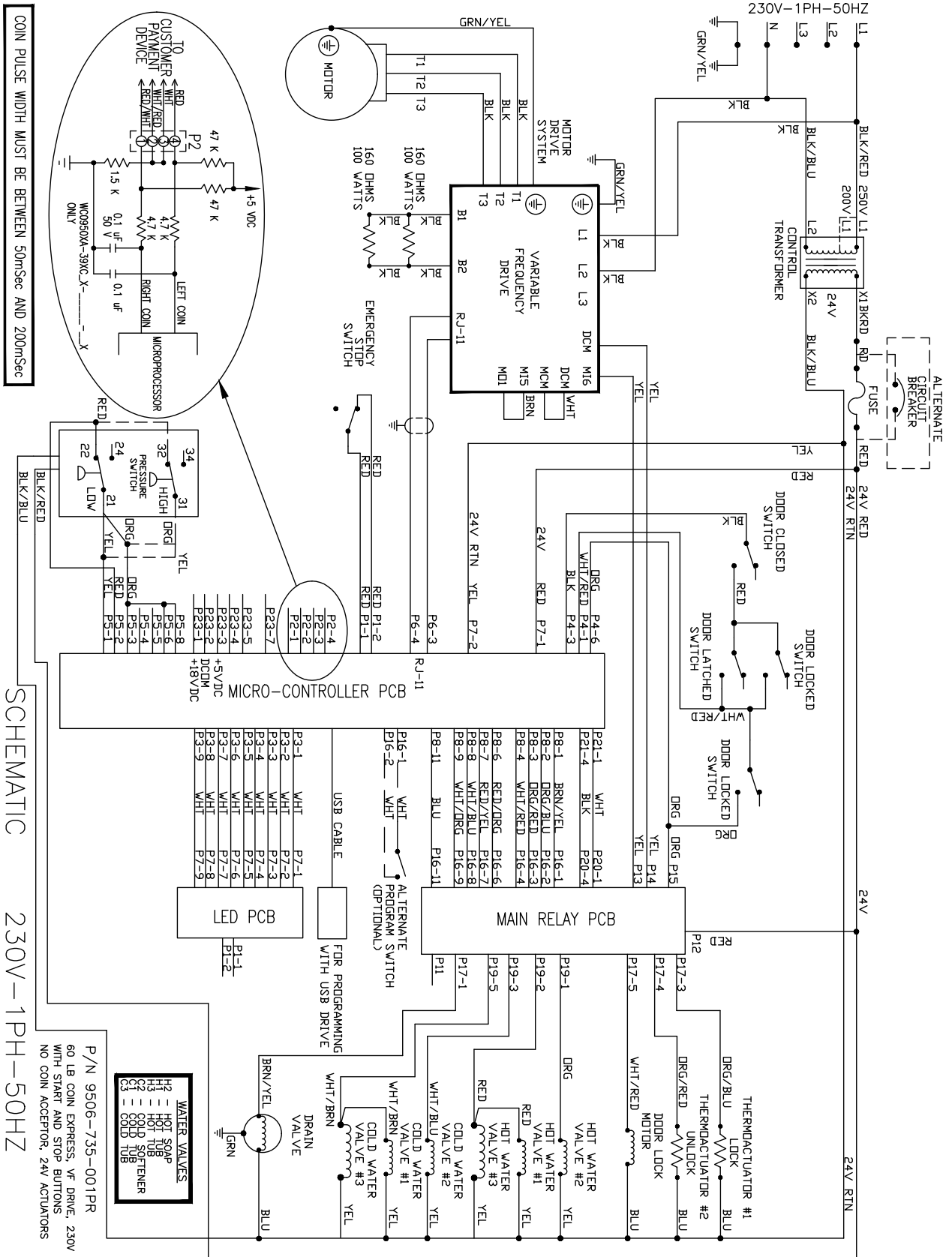

T950 230/50/1 Voltage Diagram

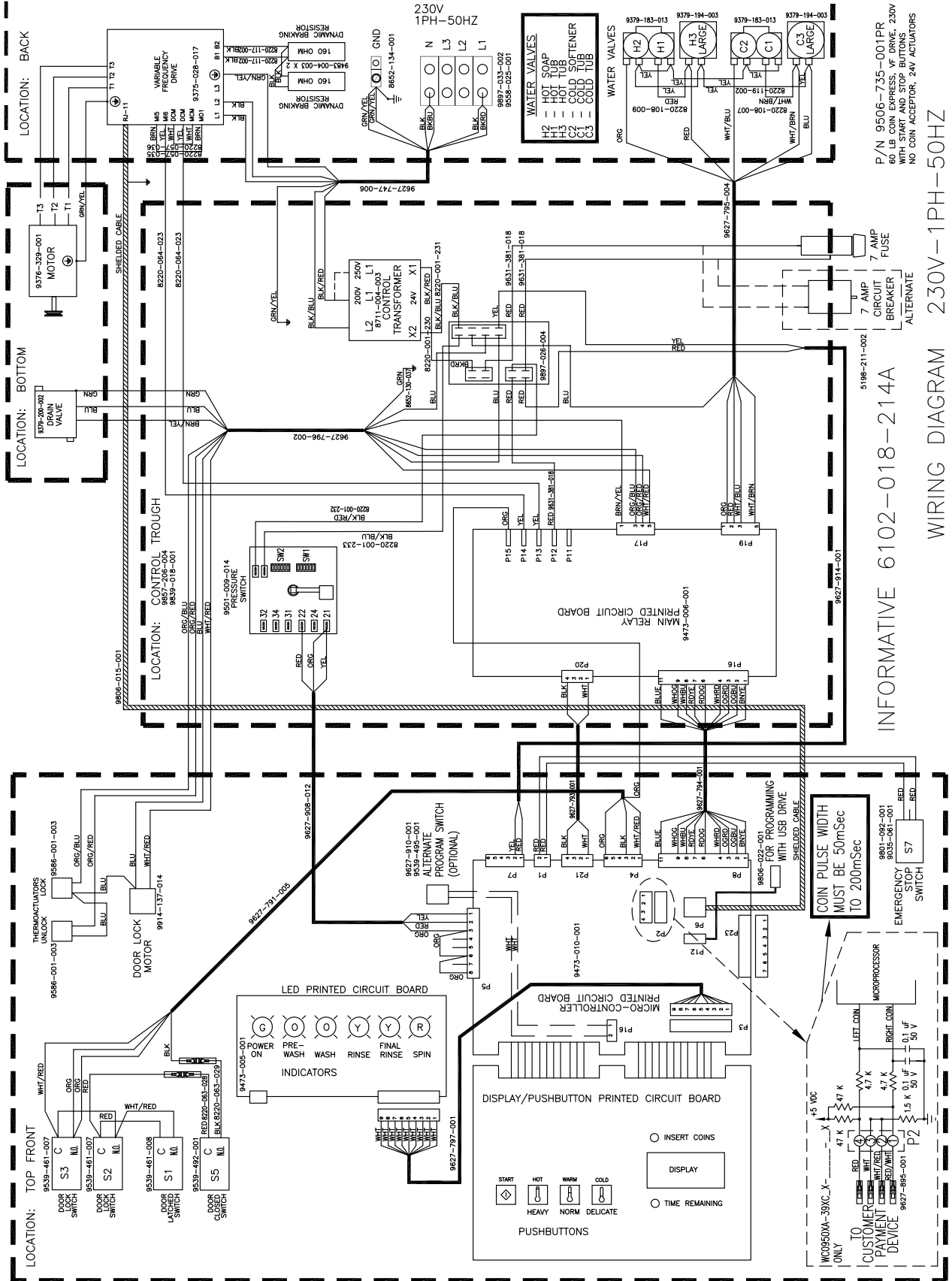

P/N 9506-735-001PR
60 LB COIN EXPRESS. VF DRIVE. 230V
WITH START AND STOP BUTTONS
NO COIN ACCEPTOR, 24V ACTUATORS

T1450 230V/50/1 Voltage Schematic

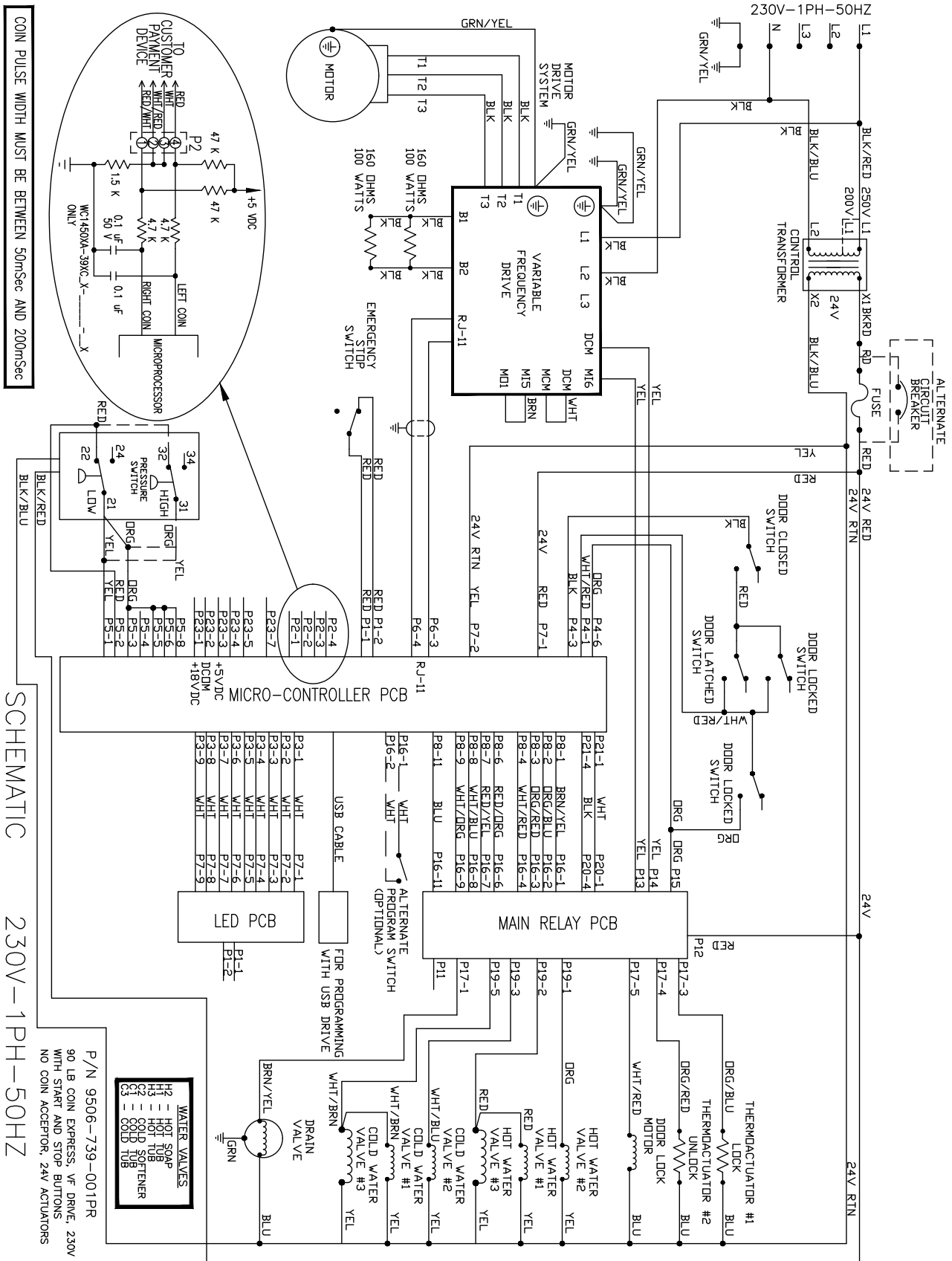

T1450 230/50/1 Voltage Diagram

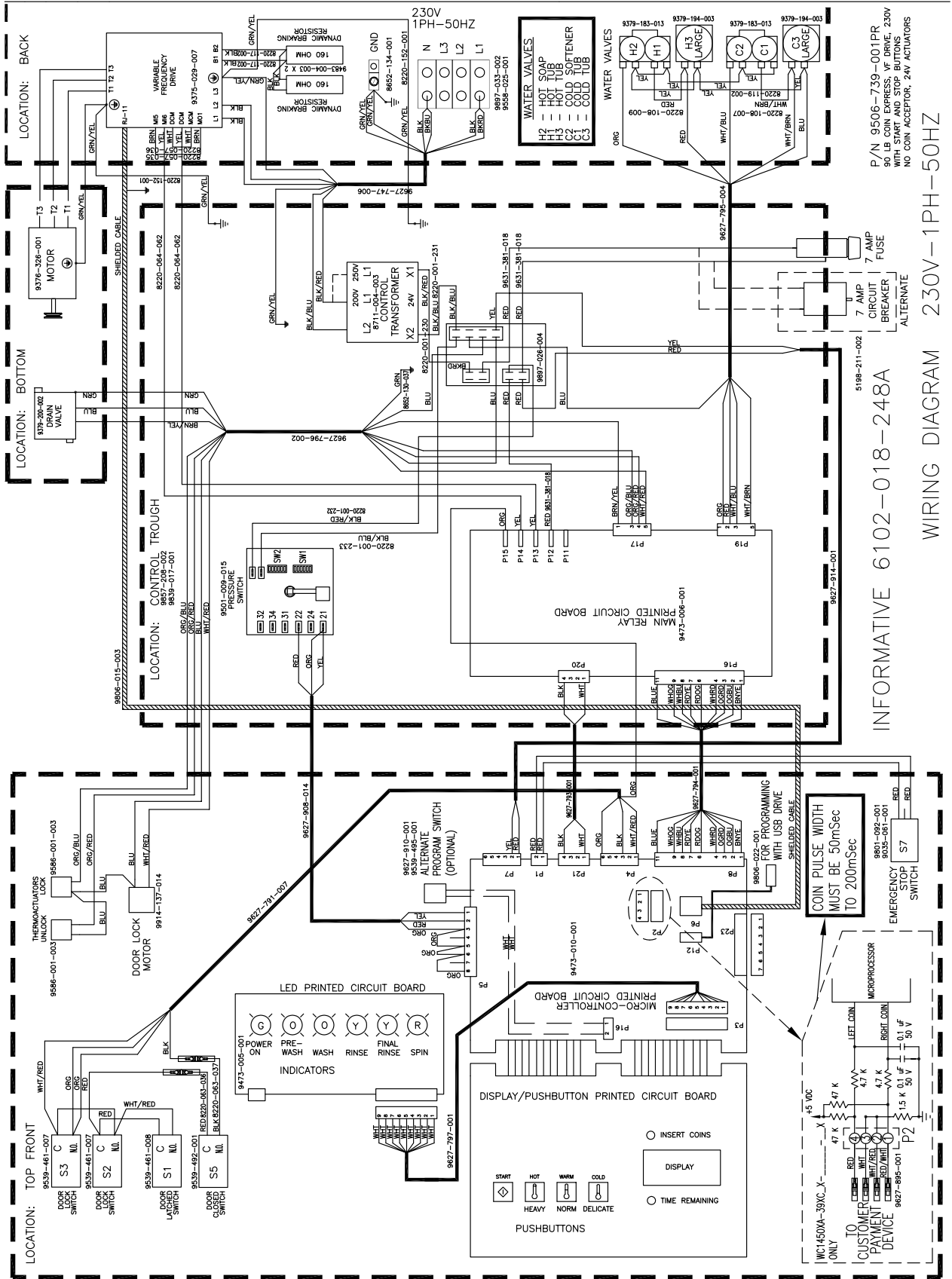

Notes

Horizontal ruling lines for notes.

Section :11

Maintenance

Preventative Maintenance

Daily

- Step 1:** Check that the loading door remains securely locked and cannot be opened during an entire cycle.
- Step 2:** Clean the top, front, and sides of the cabinet to remove residue.
- Step 3:** Clean the soap dispenser and lid and check that all dispenser mounting screws are in-place and tight.
- Step 4:** Check the loading door for leaks. Clean the door seal of all foreign matter.
- Step 5:** Leave the loading door open to aerate the washer when not in use.

Quarterly

- Step 1:** Make sure the washer is inoperative by switching off the main power supply.
- Step 2:** Check the V-belts for wear and proper tension.
- Step 3:** Clean lint and other foreign matter from around motor.
- Step 4:** Check all water connections for leaks.
- Step 5:** Check the drain valve for leaking and that it opens properly.
- Step 6:** Wipe and clean the inside of the washer and check that all electrical components are free of moisture and dust.
- Step 7:** Remove and clean water inlet hose filters. Replace if necessary.
- Step 8:** Check anchor bolts. Retighten if necessary.

Notes

Lined area for writing notes.